

EASY.

EASYDrill EASYReam

The New Universal Program

www.lmt-tools.com



EASY.

The product range for
highest efficiency and
universal application.
Easy to handle.

Diameter mm	Drilling and reaming demand			
	very high	high	high to normal	normal
	IT6	IT7	IT8	IT9
up to 14 mm		<p>EASYReam Solid</p> <p>Ø 5.0–14.0 mm</p>  <p>Page 14–18</p>	<p>EASYDrill Solid</p> <p>Ø 2.5–14.0 mm Available in tenths increments</p>  <p>Page 2–13</p>	
		<p>EASYReam Modular</p> <p>Ø 14.0–42,0 mm</p>  <p>Page 19–23</p>		
14–42 mm				

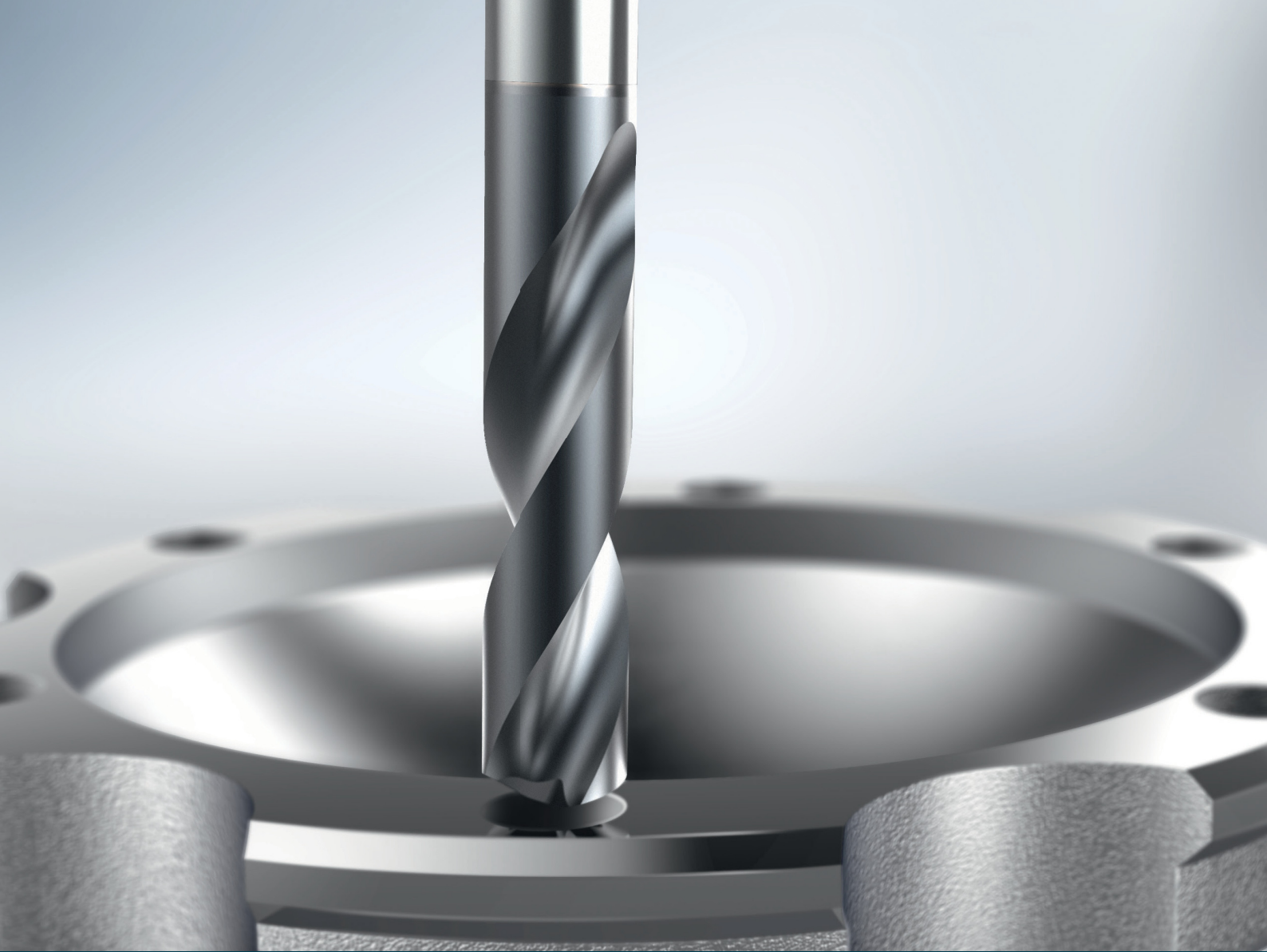

One Drill – Full Flexibility for All Drilling Operations

The EASYDrill combines maximum flexibility and efficiency in one product series. Drilling can be carried out in almost all materials via plug & play. At the same time, the advantages of the new EASYDrill family allow

time and costs in production to be significantly reduced. In addition to easy handling, it is the high level of process reliability that makes the EASYDrill the first choice for multi-sided bore machining.

Our Universal Drilling Program for Various Materials

The EASYDrill solid carbide drill with internal cooling is the perfect solution for all common drilling operations. In addition to entry on straight workpiece surfaces, slightly inclined entry or exit surfaces can also be drilled.

The EASYDrill solid carbide drill is universally applicable for steel, stainless steel, cast iron, aluminum and high-temperature alloys. The diameter range extends from Ø 2.5 mm to 14.0 mm and is also suitable in fine increments for core drilling for subsequent thread production. The EASYDrill is available in 3xD and 5xD lengths and can therefore be used in a wide range of industrial sectors.

Your advantages:

- Universal solid carbide drill offers wide range of applications
- Exceptionally long tool life in all materials
- Unbeatable cost efficiency per hole
- Impressive stability for maximum performance
- Frequent regrindability increases overall tool life

Corner protection chamfer reduces chipping

Special center slot for good chip formation

Internal cooling for higher process reliability

Straight cutting edge enables long tool life

TiAlN-based multilayer coating, high wear resistance and long tool life

Tapered core, with 30° helix, easy chip flow

Fine-grained carbide substrate reduces the risk of breakage

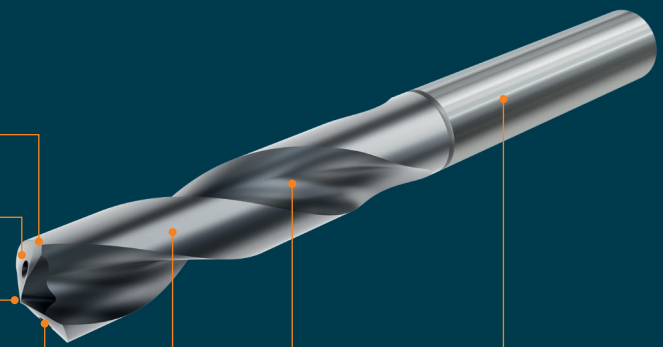

EASYDrill Solid – Application

For high-performance drilling in a wide range of materials: steel, stainless steel, cast iron, aluminum and high-temperature alloys.

P M K N S



Through hole



Blind hole



Stacked plates



Inclined entrance surface up to <math>< 3^\circ</math>



Sloping exit surface up to <math>< 20^\circ</math>

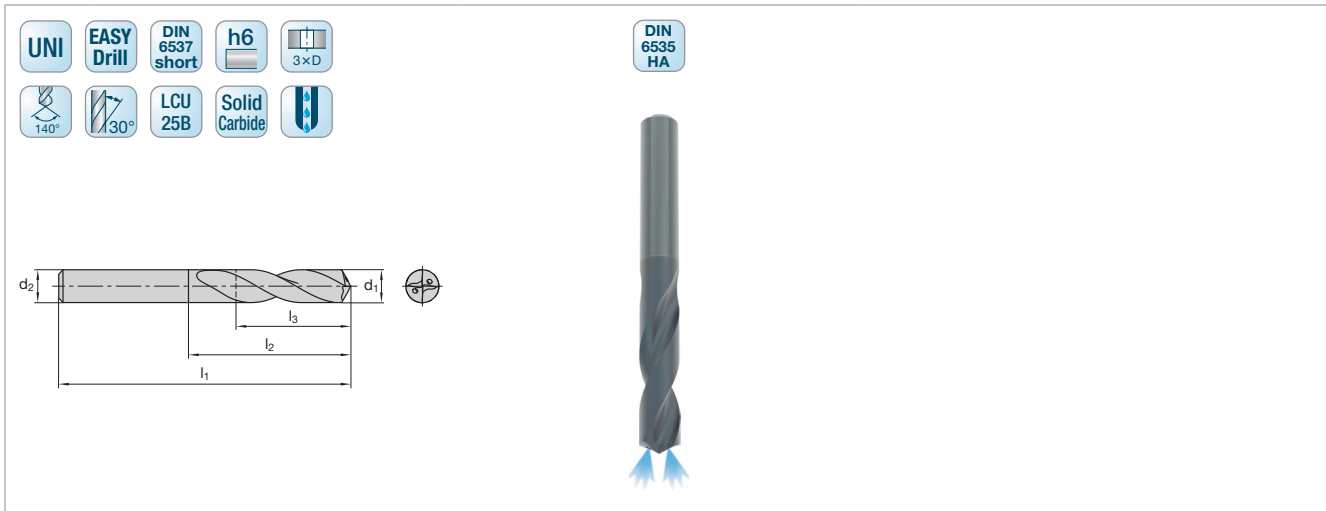

Cat.-No.					EDS01			
P								
M								
K								
N								
S								
H								
d ₁	l ₂	l ₁	l ₃	d ₂	Ident No.	LMT-Code	For taps	For forming taps
2.5	17	58	12	4	7430811	UD-EDS01 3x02500M.4HA	M 3 x 0.5	
2.6	17	58	12	4	7430902	UD-EDS01 3x02600M.4HA	UNC Nr. 5	UNF Nr. 4
2.7	17	58	12	4	7430903	UD-EDS01 3x02700M.4HA	UNF Nr. 5	
2.8	17	58	12	4	7430904	UD-EDS01 3x02800M.4HA	UNC Nr. 6	M 3 x 0.5
2.9	17	58	12	4	7430905	UD-EDS01 3x02900M.4HA	M 3.5 x 0.6; UNF Nr. 6	UNC Nr. 5; UNF Nr. 5
3	20	62	14	6	7430906	UD-EDS01 3x03000M.6HA		
3.1	20	62	14	6	7430907	UD-EDS01 3x03100M.6HA		
3.2	20	62	14	6	7430908	UD-EDS01 3x03200M.6HA		M 3.5 x 0.6; UNF Nr. 6
3.3	20	62	14	6	7430909	UD-EDS01 3x03300M.6HA	M 4 x 0.7	
3.4	20	62	14	6	7430910	UD-EDS01 3x03400M.6HA	UNC Nr. 8	
3.5	20	62	14	6	7430911	UD-EDS01 3x03500M.6HA	MF 4 x 0.5; UNF Nr. 8	
3.6	20	62	14	6	7430912	UD-EDS01 3x03600M.6HA		
3.65	20	62	14	6	7446232	UD-EDS01 3x03650M.6HA	MF 4 x 0.35	
3.7	20	62	14	6	7430913	UD-EDS01 3x03700M.6HA		M 4 x 0.7
3.8	24	66	17	6	7430914	UD-EDS01 3x03800M.6HA	M 4.5 x 0.75	UNC Nr. 8
3.9	24	66	17	6	7430915	UD-EDS01 3x03900M.6HA	UNC Nr. 10	
4	24	66	17	6	7430916	UD-EDS01 3x04000M.6HA		
4.1	24	66	17	6	7430917	UD-EDS01 3x04100M.6HA	UNF Nr. 10	
4.2	24	66	17	6	7430918	UD-EDS01 3x04200M.6HA	M 5 x 0.8	
4.3	24	66	17	6	7430919	UD-EDS01 3x04300M.6HA		UNC Nr. 10
4.4	24	66	17	6	7430920	UD-EDS01 3x04400M.6HA		
4.5	24	66	17	6	7430921	UD-EDS01 3x04500M.6HA	MF 5 x 0.5; UNC Nr. 12	
4.6	24	66	17	6	7430922	UD-EDS01 3x04600M.6HA	UNF Nr. 12	
4.65	24	66	17	6	7446233	UD-EDS01 3x04650M.6HA		M 5 x 0.8
4.7	24	66	17	6	7430923	UD-EDS01 3x04700M.6HA		
4.8	28	66	20	6	7430924	UD-EDS01 3x04800M.6HA		
4.9	28	66	20	6	7430925	UD-EDS01 3x04900M.6HA		
5	28	66	20	6	7430926	UD-EDS01 3x05000M.6HA	M 6 x 1	UNC Nr. 12
5.1	28	66	20	6	7430927	UD-EDS01 3x05100M.6HA	UNC ¼	
5.2	28	66	20	6	7431258	UD-EDS01 3x05200M.6HA		
5.3	28	66	20	6	7431260	UD-EDS01 3x05300M.6HA	MF 6 x 0.75	
5.4	28	66	20	6	7431262	UD-EDS01 3x05400M.6HA		
5.5	28	66	20	6	7431264	UD-EDS01 3x05500M.6HA	MF 6 x 0.5; UNF ¼	

Cutting data recommendations see page 12

■ = First choice
□ = Alternative

for HPF-Forming taps



In addition to the standard program, special tools upon request.



Cat.-No.		EDS01						
P		■						
M		■						
K		■						
N		■						
S		■						
H		□						
d ₁	l ₂	l ₁	l ₃	d ₂	Ident No.	LMT-Code	For taps	For forming taps
5.55	28	66	20	6	7446234	UD-EDS01 3x05550M.6HA		M 6 x 1
5.6	28	66	20	6	7431266	UD-EDS01 3x05600M.6HA		
5.7	28	66	20	6	7431268	UD-EDS01 3x05700M.6HA		
5.8	28	66	20	6	7431270	UD-EDS01 3x05800M.6HA		
5.9	28	66	20	6	7431273	UD-EDS01 3x05900M.6HA		UNF ¼
6	28	66	20	6	7431275	UD-EDS01 3x06000M.6HA	M 7 x 1	
6.1	34	79	24	8	7431277	UD-EDS01 3x06100M.8HA		
6.2	34	79	24	8	7431278	UD-EDS01 3x06200M.8HA		
6.25	34	79	24	8	7446235	UD-EDS01 3x06250M.8HA	MF 7 x 0.75	
6.3	34	79	24	8	7431280	UD-EDS01 3x06300M.8HA		
6.4	34	79	24	8	7431282	UD-EDS01 3x06400M.8HA		
6.5	34	79	24	8	7431284	UD-EDS01 3x06500M.8HA		
6.55	34	79	24	8	7446236	UD-EDS01 3x06550M.8HA		M 7 x 1
6.6	34	79	24	8	7431286	UD-EDS01 3x06600M.8HA	UNC 5/16	
6.7	34	79	24	8	7431288	UD-EDS01 3x06700M.8HA		
6.8	34	79	24	8	7431290	UD-EDS01 3x06800M.8HA	M 8 x 1.25; G 1/16	
6.9	34	79	24	8	7431292	UD-EDS01 3x06900M.8HA	UNF 5/16	
7	34	79	24	8	7431294	UD-EDS01 3x07000M.8HA	MF 8 x 1	
7.1	41	79	29	8	7431296	UD-EDS01 3x07100M.8HA		
7.2	41	79	29	8	7431298	UD-EDS01 3x07200M.8HA		
7.25	41	79	29	8	7446237	UD-EDS01 3x07250M.8HA	MF 8 x 0.75	UNC 5/16; G 1/16"
7.3	41	79	29	8	7431300	UD-EDS01 3x07300M.8HA		
7.4	41	79	29	8	7431302	UD-EDS01 3x07400M.8HA		
7.45	41	79	29	8	7446238	UD-EDS01 3x07450M.8HA		M 8 x 1.25; UNF 5/16"
7.5	41	79	29	8	7431304	UD-EDS01 3x07500M.8HA	MF 8 x 0.5	
7.55	41	79	29	8	7446239	UD-EDS01 3x07550M.8HA		MF 8 x 1
7.6	41	79	29	8	7431307	UD-EDS01 3x07600M.8HA		
7.7	41	79	29	8	7431309	UD-EDS01 3x07700M.8HA		
7.8	41	79	29	8	7431311	UD-EDS01 3x07800M.8HA	M 9 x 1.25	
7.9	41	79	29	8	7431313	UD-EDS01 3x07900M.8HA		
8	41	79	29	8	7431315	UD-EDS01 3x08000M.8HA	MF 9 x 1; UNC 3/8	
8.1	47	89	35	10	7431317	UD-EDS01 3x08100M.10HA		
8.2	47	89	35	10	7431319	UD-EDS01 3x08200M.10HA		

Cutting data recommendations see page 12

■ = First choice
□ = Alternative

■ for HPF-Forming taps



In addition to the standard program, special tools upon request.

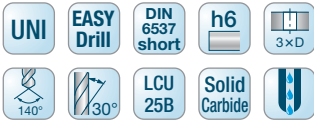

DIN 6535 HA

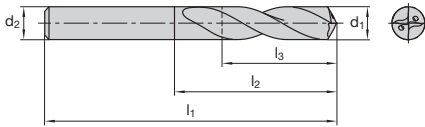

Cat.-No.					EDS01				
P									
M									
K									
N									
S									
H									
d ₁	l ₂	l ₁	l ₃	d ₂	Ident No.	LMT-Code	For taps	For forming taps	
8.3	47	89	35	10	7431321	UD-EDS01 3x08300M.10HA	MF 9 x 0.75		
8.4	47	89	35	10	7431323	UD-EDS01 3x08400M.10HA		M 9 x 1.25	
8.5	47	89	35	10	7431325	UD-EDS01 3x08500M.10HA	M 10 x 1.5; UNF 3/8		
8.6	47	89	35	10	7431327	UD-EDS01 3x08600M.10HA			
8.7	47	89	35	10	7431329	UD-EDS01 3x08700M.10HA			
8.75	47	89	35	10	7446240	UD-EDS01 3x08750M.10HA	MF 10 x 1.25	UNC 3/8	
8.8	47	89	35	10	7431331	UD-EDS01 3x08800M.10HA	G 1/8		
8.9	47	89	35	10	7431333	UD-EDS01 3x08900M.10HA			
9	47	89	35	10	7431335	UD-EDS01 3x09000M.10HA	MF 10 x 1	UNF 3/8	
9.1	47	89	35	10	7431337	UD-EDS01 3x09100M.10HA			
9.2	47	89	35	10	7431339	UD-EDS01 3x09200M.10HA			
9.25	47	89	35	10	7446241	UD-EDS01 3x09250M.10HA	MF 10 x 0.75	G 1/8	
9.3	47	89	35	10	7431341	UD-EDS01 3x09300M.10HA		M 10 x 1.5	
9.4	47	89	35	10	7431343	UD-EDS01 3x09400M.10HA	UNC 7/16	MF 10 x 1.25	
9.5	47	89	35	10	7431345	UD-EDS01 3x09500M.10HA	M 11 x 1.5		
9.55	47	89	35	10	7446242	UD-EDS01 3x09550M.10HA		MF 10 x 1	
9.6	47	89	35	10	7431347	UD-EDS01 3x09600M.10HA			
9.7	47	89	35	10	7431349	UD-EDS01 3x09700M.10HA		MF 10 x 0.75	
9.8	47	89	35	10	7431351	UD-EDS01 3x09800M.10HA			
9.9	47	89	35	10	7431353	UD-EDS01 3x09900M.10HA	UNF 7/16		
10	47	89	35	10	7430861	UD-EDS01 3x10000M.10HA	MF 11 x 1		
10.1	55	102	40	12	7430862	UD-EDS01 3x10100M.12HA			
10.2	55	102	40	12	7430863	UD-EDS01 3x10200M.12HA		UNC 7/16	
10.3	55	102	40	12	7430864	UD-EDS01 3x10300M.12HA	M 12 x 1.75		
10.4	55	102	40	12	7430865	UD-EDS01 3x10400M.12HA			
10.5	55	102	40	12	7430866	UD-EDS01 3x10500M.12HA	MF 12 x 1.5	UNF 7/16	
10.6	55	102	40	12	7430867	UD-EDS01 3x10600M.12HA			
10.7	55	102	40	12	7430868	UD-EDS01 3x10700M.12HA			
10.8	55	102	40	12	7430869	UD-EDS01 3x10800M.12HA	MF 12 x 1.25; UNC 1/2		
10.9	55	102	40	12	7430870	UD-EDS01 3x10900M.12HA			
11	55	102	40	12	7430871	UD-EDS01 3x11000M.12HA	MF 12 x 1		
11.1	55	102	40	12	7430872	UD-EDS01 3x11100M.12HA			
11.2	55	102	40	12	7430873	UD-EDS01 3x11200M.12HA		M 12 x 1.75	

Cutting data recommendations see page 12

■ = First choice
□ = Alternative

■ for HPF-Forming taps



In addition to the standard program, special tools upon request.

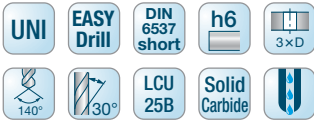

DIN 6535 HA

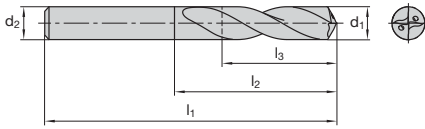

Cat.-No.		EDS01							
P		■							
M		■							
K		■							
N		■							
S		■							
H		□							
d ₁	l ₂	l ₁	l ₃	d ₂	Ident No.	LMT-Code	For taps	For forming taps	
11.3	55	102	40	12	7430874	UD-EDS01 3x11300M.12HA		MF 12 x 1.5	
11.4	55	102	40	12	7430875	UD-EDS01 3x11400M.12HA		MF 12 x 1.25	
11.5	55	102	40	12	7430876	UD-EDS01 3x11500M.12HA	UNF ½		
11.55	55	102	40	12	7446243	UD-EDS01 3x11550M.12HA		MF 12 x 1	
11.6	55	102	40	12	7430877	UD-EDS01 3x11600M.12HA			
11.7	55	102	40	12	7430878	UD-EDS01 3x11700M.12HA		UNC ½	
11.8	55	102	40	12	7430879	UD-EDS01 3x11800M.12HA	G ¼		
11.9	55	102	40	12	7430880	UD-EDS01 3x11900M.12HA			
12	55	102	40	12	7430881	UD-EDS01 3x12000M.12HA	M 14 x 2		
12.1	60	107	43	14	7430882	UD-EDS01 3x12100M.14HA		UNF ½	
12.2	60	107	43	14	7430883	UD-EDS01 3x12200M.14HA	UNC 9/16		
12.3	60	107	43	14	7430884	UD-EDS01 3x12300M.14HA			
12.4	60	107	43	14	7430885	UD-EDS01 3x12400M.14HA			
12.5	60	107	43	14	7430886	UD-EDS01 3x12500M.14HA	MF 14 x 1.5	G ¼	
12.6	60	107	43	14	7430887	UD-EDS01 3x12600M.14HA			
12.7	60	107	43	14	7430888	UD-EDS01 3x12700M.14HA			
12.8	60	107	43	14	7430889	UD-EDS01 3x12800M.14HA	MF 14 x 1.25		
12.9	60	107	43	14	7430890	UD-EDS01 3x12900M.14HA	UNF 9/16		
13	60	107	43	14	7430891	UD-EDS01 3x13000M.14HA	MF 14 x 1		
13.1	60	107	43	14	7430892	UD-EDS01 3x13100M.14HA		M 14 x 2	
13.2	60	107	43	14	7430893	UD-EDS01 3x13200M.14HA		UNC 9/16	
13.3	60	107	43	14	7430894	UD-EDS01 3x13300M.14HA		MF 14 x 1.5	
13.4	60	107	43	14	7430895	UD-EDS01 3x13400M.14HA			
13.5	60	107	43	14	7430896	UD-EDS01 3x13500M.14HA	MF 15 x 1.5; UNC 5/8		
13.55	60	107	43	14	7446244	UD-EDS01 3x13550M.14HA		MF 14 x 1	
13.6	60	107	43	14	7430897	UD-EDS01 3x13600M.14HA		UNF 9/16	
13.7	60	107	43	14	7430898	UD-EDS01 3x13700M.14HA			
13.8	60	107	43	14	7430899	UD-EDS01 3x13800M.14HA			
13.9	60	107	43	14	7430900	UD-EDS01 3x13900M.14HA			
14	60	107	43	14	7430901	UD-EDS01 3x14000M.14HA	M 16 x 2; MF 15 x 1		

Cutting data recommendations see page 12

■ = First choice
□ = Alternative

■ for HPF-Forming taps

In addition to the standard program, special tools upon request.

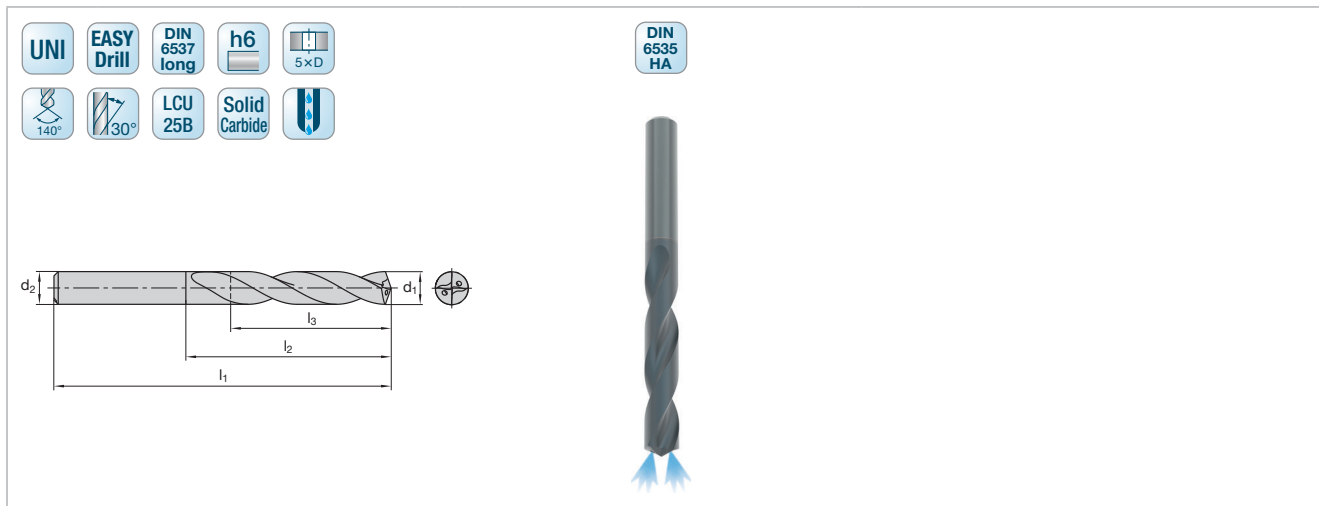

Cat.-No.		EDS01							
P		■							
M		■							
K		■							
N		■							
S		■							
H		□							
d ₁	l ₂	l ₁	l ₃	d ₂	Ident No.	LMT-Code	For taps	For forming taps	
2.5	22	58	17	4	7431019	UD-EDS01 5x02500M.4HA	M 3 x 0.5		
2.6	22	58	17	4	7431020	UD-EDS01 5x02600M.4HA	UNC Nr. 5	UNF Nr. 4	
2.7	22	58	17	4	7431021	UD-EDS01 5x02700M.4HA	UNF Nr. 5		
2.8	22	58	17	4	7431022	UD-EDS01 5x02800M.4HA	UNC Nr. 6	M 3 x 0.5	
2.9	22	58	17	4	7431023	UD-EDS01 5x02900M.4HA	M 3.5 x 0.6; UNF Nr. 6	UNC Nr. 5; UNF Nr. 5	
3	28	66	23	6	7431024	UD-EDS01 5x03000M.6HA			
3.1	28	66	23	6	7431025	UD-EDS01 5x03100M.6HA			
3.2	28	66	23	6	7431026	UD-EDS01 5x03200M.6HA		M 3.5 x 0.6; UNF Nr. 6	
3.3	28	66	23	6	7431027	UD-EDS01 5x03300M.6HA	M 4 x 0.7		
3.4	28	66	23	6	7431028	UD-EDS01 5x03400M.6HA	UNC Nr. 8		
3.5	28	66	23	6	7431029	UD-EDS01 5x03500M.6HA	MF 4 x 0.5; UNF Nr. 8		
3.6	28	66	23	6	7431030	UD-EDS01 5x03600M.6HA			
3.7	28	66	23	6	7431031	UD-EDS01 5x03700M.6HA		M 4 x 0.7	
3.8	36	74	29	6	7431032	UD-EDS01 5x03800M.6HA	M 4.5 x 0.75	UNC Nr. 8	
3.9	36	74	29	6	7431033	UD-EDS01 5x03900M.6HA	UNC Nr. 10		
4	36	74	29	6	7431034	UD-EDS01 5x04000M.6HA			
4.1	36	74	29	6	7431035	UD-EDS01 5x04100M.6HA	UNF Nr. 10		
4.2	36	74	29	6	7431036	UD-EDS01 5x04200M.6HA	M 5 x 0.8		
4.3	36	74	29	6	7431037	UD-EDS01 5x04300M.6HA		UNC Nr. 10	
4.4	36	74	29	6	7431038	UD-EDS01 5x04400M.6HA			
4.5	36	74	29	6	7431039	UD-EDS01 5x04500M.6HA	MF 5 x 0.5; UNC Nr. 12		
4.6	36	74	29	6	7431040	UD-EDS01 5x04600M.6HA	UNF Nr. 12		
4.7	36	74	29	6	7431041	UD-EDS01 5x04700M.6HA			
4.8	44	82	35	6	7431042	UD-EDS01 5x04800M.6HA			
4.9	44	82	35	6	7431043	UD-EDS01 5x04900M.6HA			
5	44	82	35	6	7431044	UD-EDS01 5x05000M.6HA	M 6 x 1	UNC Nr. 12	
5.1	44	82	35	6	7431259	UD-EDS01 5x05100M.6HA	UNC 1/4		
5.2	44	82	35	6	7431261	UD-EDS01 5x05200M.6HA			
5.3	44	82	35	6	7431263	UD-EDS01 5x05300M.6HA	MF 6 x 0.75		
5.4	44	82	35	6	7431265	UD-EDS01 5x05400M.6HA			
5.5	44	82	35	6	7431267	UD-EDS01 5x05500M.6HA	MF 6 x 0.5; UNF 1/4		
5.6	44	82	35	6	7431269	UD-EDS01 5x05600M.6HA			

Cutting data recommendations see page 12

■ = First choice
□ = Alternative

□ for HPF-Forming taps



In addition to the standard program, special tools upon request.

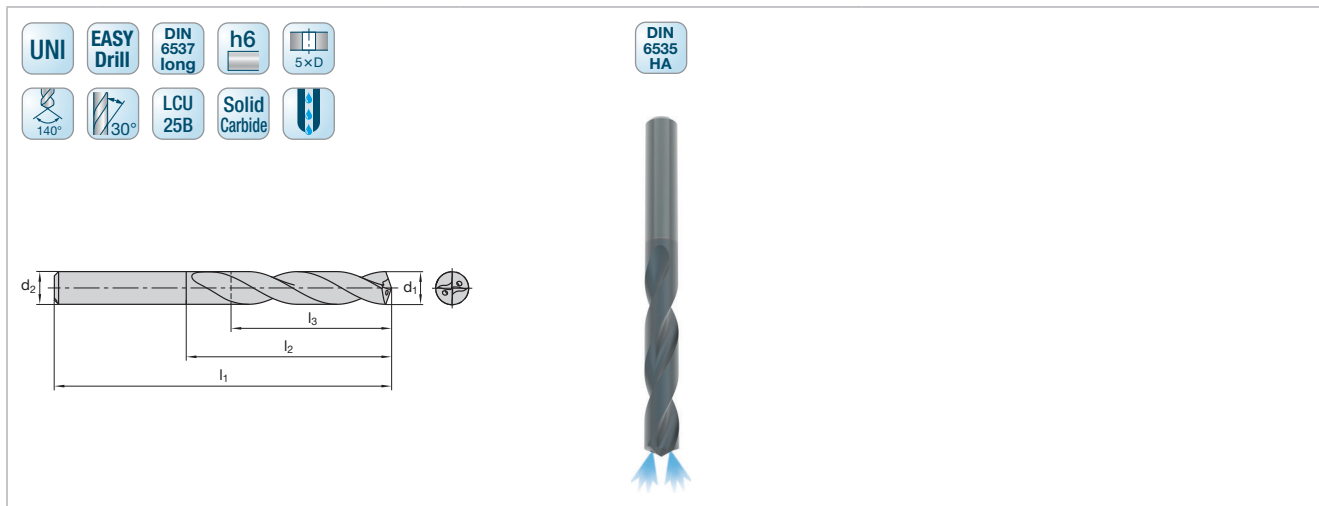

Cat.-No.		EDS01						
P								
M								
K								
N								
S								
H								
d ₁	l ₂	l ₁	l ₃	d ₂	Ident No.	LMT-Code	For taps	For forming taps
5.7	44	82	35	6	7431271	UD-EDS01 5x05700M.6HA		
5.8	44	82	35	6	7431272	UD-EDS01 5x05800M.6HA		
5.9	44	82	35	6	7431274	UD-EDS01 5x05900M.6HA		UNF ¼
6	44	82	35	6	7431276	UD-EDS01 5x06000M.6HA	M 7 x 1	
6.1	53	91	43	8	7431279	UD-EDS01 5x06100M.8HA		
6.2	53	91	43	8	7431281	UD-EDS01 5x06200M.8HA		
6.3	53	91	43	8	7431283	UD-EDS01 5x06300M.8HA		
6.4	53	91	43	8	7431285	UD-EDS01 5x06400M.8HA		
6.5	53	91	43	8	7431287	UD-EDS01 5x06500M.8HA		
6.6	53	91	43	8	7431289	UD-EDS01 5x06600M.8HA	UNC 5/16	
6.7	53	91	43	8	7431291	UD-EDS01 5x06700M.8HA		
6.8	53	91	43	8	7431293	UD-EDS01 5x06800M.8HA	M 8 x 1.25; G 1/16	
6.9	53	91	43	8	7431295	UD-EDS01 5x06900M.8HA	UNF 5/16	
7	53	91	43	8	7431297	UD-EDS01 5x07000M.8HA	MF 8 x 1	
7.1	53	91	43	8	7431299	UD-EDS01 5x07100M.8HA		
7.2	53	91	43	8	7431301	UD-EDS01 5x07200M.8HA		
7.3	53	91	43	8	7431303	UD-EDS01 5x07300M.8HA		
7.4	53	91	43	8	7431305	UD-EDS01 5x07400M.8HA		
7.5	53	91	43	8	7431306	UD-EDS01 5x07500M.8HA	MF 8 x 0.5	
7.6	53	91	43	8	7431308	UD-EDS01 5x07600M.8HA		
7.7	53	91	43	8	7431310	UD-EDS01 5x07700M.8HA		
7.8	53	91	43	8	7431312	UD-EDS01 5x07800M.8HA	M 9 x 1.25	
7.9	53	91	43	8	7431314	UD-EDS01 5x07900M.8HA		
8	53	91	43	8	7431316	UD-EDS01 5x08000M.8HA	MF 9 x 1; UNC 3/8	
8.1	61	103	49	10	7431318	UD-EDS01 5x08100M.10HA		
8.2	61	103	49	10	7431320	UD-EDS01 5x08200M.10HA		
8.3	61	103	49	10	7431322	UD-EDS01 5x08300M.10HA	MF 9 x 0.75	
8.4	61	103	49	10	7431324	UD-EDS01 5x08400M.10HA		M 9 x 1.25
8.5	61	103	49	10	7431326	UD-EDS01 5x08500M.10HA	M 10 x 1.5; UNF 3/8	
8.6	61	103	49	10	7431328	UD-EDS01 5x08600M.10HA		
8.7	61	103	49	10	7431330	UD-EDS01 5x08700M.10HA		
8.8	61	103	49	10	7431332	UD-EDS01 5x08800M.10HA	G 1/8	

Cutting data recommendations see page 12

■ = First choice
□ = Alternative

for HPF-Forming taps



In addition to the standard program, special tools upon request.

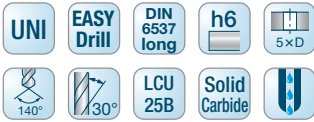

DIN
6535
HA

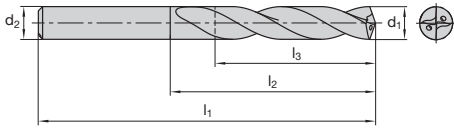

Cat.-No.		EDS01						
P								
M								
K								
N								
S								
H								
d ₁	l ₂	l ₁	l ₃	d ₂	Ident No.	LMT-Code	For taps	For forming taps
8.9	61	103	49	10	7431334	UD-EDS01 5x08900M.10HA		
9	61	103	49	10	7431336	UD-EDS01 5x09000M.10HA	MF 10 x 1	UNF 3/8
9.1	61	103	49	10	7431338	UD-EDS01 5x09100M.10HA		
9.2	61	103	49	10	7431340	UD-EDS01 5x09200M.10HA		
9.3	61	103	49	10	7431342	UD-EDS01 5x09300M.10HA		M 10 x 1,5
9.4	61	103	49	10	7431344	UD-EDS01 5x09400M.10HA	UNC 7/16	MF 10 x 1,25
9.5	61	103	49	10	7431346	UD-EDS01 5x09500M.10HA	M 11 x 1.5	
9.6	61	103	49	10	7431348	UD-EDS01 5x09600M.10HA		
9.7	61	103	49	10	7431350	UD-EDS01 5x09700M.10HA		MF 10 x 0,75
9.8	61	103	49	10	7431352	UD-EDS01 5x09800M.10HA		
9.9	61	103	49	10	7431354	UD-EDS01 5x09900M.10HA	UNF 7/16	
10	61	103	49	10	7430978	UD-EDS01 5x10000M.10HA	MF 11 x 1	
10.1	71	118	56	12	7430979	UD-EDS01 5x10100M.12HA		
10.2	71	118	56	12	7430980	UD-EDS01 5x10200M.12HA		UNC 7/16
10.3	71	118	56	12	7430981	UD-EDS01 5x10300M.12HA	M 12 x 1.75	
10.4	71	118	56	12	7430982	UD-EDS01 5x10400M.12HA		
10.5	71	118	56	12	7430983	UD-EDS01 5x10500M.12HA	MF 12 x 1.5	UNF 7/16
10.6	71	118	56	12	7430984	UD-EDS01 5x10600M.12HA		
10.7	71	118	56	12	7430985	UD-EDS01 5x10700M.12HA		
10.8	71	118	56	12	7430986	UD-EDS01 5x10800M.12HA	MF 12 x 1.25; UNC ½	
10.9	71	118	56	12	7430987	UD-EDS01 5x10900M.12HA		
11	71	118	56	12	7430988	UD-EDS01 5x11000M.12HA	MF 12 x 1	
11.1	71	118	56	12	7430989	UD-EDS01 5x11100M.12HA		
11.2	71	118	56	12	7430990	UD-EDS01 5x11200M.12HA		M 12 x 1,75
11.3	71	118	56	12	7430991	UD-EDS01 5x11300M.12HA		MF 12 x 1,5
11.4	71	118	56	12	7430992	UD-EDS01 5x11400M.12HA		MF 12 x 1,25
11.5	71	118	56	12	7430993	UD-EDS01 5x11500M.12HA	UNF ½	
11.6	71	118	56	12	7430994	UD-EDS01 5x11600M.12HA		
11.7	71	118	56	12	7430995	UD-EDS01 5x11700M.12HA		UNC ½
11.8	71	118	56	12	7430996	UD-EDS01 5x11800M.12HA	G ¼	
11.9	71	118	56	12	7430997	UD-EDS01 5x11900M.12HA		
12	77	124	60	14	7430998	UD-EDS01 5x12000M.14HA	M 14 x 2	

Cutting data recommendations see page 12

■ = First choice
□ = Alternative

for HPF-Forming taps



In addition to the standard program, special tools upon request.

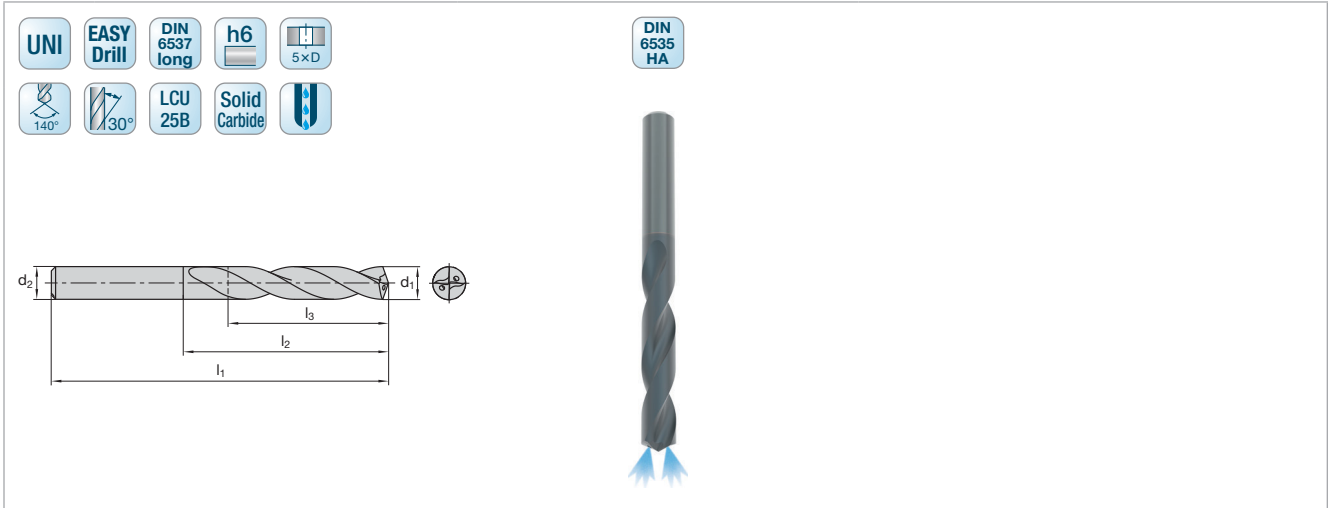

Cat.-No.		EDS01						
P		■						
M		■						
K		■						
N		■						
S		■						
H		□						
d ₁	l ₂	l ₁	l ₃	d ₂	Ident No.	LMT-Code	For taps	For forming taps
12.1	77	124	60	14	7430999	UD-EDS01 5x12100M.14HA		UNF ½
12.2	77	124	60	14	7431000	UD-EDS01 5x12200M.14HA	UNC 9/16	
12.3	77	124	60	14	7431001	UD-EDS01 5x12300M.14HA		
12.4	77	124	60	14	7431002	UD-EDS01 5x12400M.14HA		
12.5	77	124	60	14	7431003	UD-EDS01 5x12500M.14HA	MF 14 x 1.5	G ¼
12.6	77	124	60	14	7431004	UD-EDS01 5x12600M.14HA		
12.7	77	124	60	14	7431005	UD-EDS01 5x12700M.14HA		
12.8	77	124	60	14	7431006	UD-EDS01 5x12800M.14HA	MF 14 x 1.25	
12.9	77	124	60	14	7431007	UD-EDS01 5x12900M.14HA	UNF 9/16	
13	77	124	60	14	7431008	UD-EDS01 5x13000M.14HA	MF 14 x 1	
13.1	77	124	60	14	7431009	UD-EDS01 5x13100M.14HA		M 14 x 2
13.2	77	124	60	14	7431010	UD-EDS01 5x13200M.14HA		UNC 9/16
13.3	77	124	60	14	7431011	UD-EDS01 5x13300M.14HA		MF 14 x 1,5
13.4	77	124	60	14	7431012	UD-EDS01 5x13400M.14HA		
13.5	77	124	60	14	7431013	UD-EDS01 5x13500M.14HA	MF 15 x 1.5; UNC 5/8	
13.6	77	124	60	14	7431014	UD-EDS01 5x13600M.14HA		UNF 9/16
13.7	77	124	60	14	7431015	UD-EDS01 5x13700M.14HA		
13.8	77	124	60	14	7431016	UD-EDS01 5x13800M.14HA		
13.9	77	124	60	14	7431017	UD-EDS01 5x13900M.14HA		
14	77	124	60	14	7431018	UD-EDS01 5x14000M.14HA	M 16 x 2; MF 15 x 1	

Cutting data recommendations see page 12

■ = First choice
□ = Alternative

■ for HPF-Forming taps

In addition to the standard program, special tools upon request.

Material Group	Cutting speed v_c (m/min)	Drill diameter (mm)							
		Feed per revolution f (mm/U)							
		Ø 2.5	Ø 3.0	Ø 4.0	Ø 6.0	Ø 8.0	Ø 10.0	Ø 12.0	Ø 14.0
P1	100-130	0.04-0.10	0.05-0.12	0.05-0.12	0.10-0.20	0.12-0.25	0.13-0.30	0.16-0.35	0.18-0.38
P2	100-120	0.05-0.13	0.07-0.15	0.07-0.15	0.13-0.23	0.15-0.27	0.18-0.33	0.21-0.37	0.23-0.41
P3	60-80	0.05-0.10	0.06-0.12	0.06-0.13	0.10-0.20	0.13-0.24	0.15-0.29	0.17-0.32	0.18-0.36
M1	35-45	0.03-0.06	0.04-0.07	0.04-0.08	0.08-0.13	0.09-0.14	0.11-0.16	0.13-0.18	0.14-0.19
M2	55-70	0.04-0.06	0.05-0.08	0.06-0.10	0.08-0.14	0.10-0.18	0.13-0.22	0.14-0.24	0.16-0.28
K1	125-170	0.09-0.18	0.12-0.23	0.12-0.23	0.17-0.33	0.21-0.40	0.24-0.46	0.26-0.51	0.29-0.57
K2	110-135	0.09-0.16	0.10-0.17	0.10-0.17	0.15-0.26	0.16-0.33	0.21-0.38	0.23-0.42	0.26-0.46
N1	210-315	0.06-0.14	0.08-0.15	0.08-0.15	0.13-0.21	0.17-0.25	0.21-0.29	0.25-0.34	0.27-0.38
N2	180-270	0.06-0.13	0.08-0.17	0.08-0.17	0.13-0.25	0.17-0.29	0.21-0.34	0.25-0.38	0.27-0.42
N3	180-270	0.12-0.15	0.13-0.15	0.13-0.15	0.15-0.21	0.17-0.25	0.21-0.29	0.25-0.34	0.27-0.38
N4	135-180	0.06-0.13	0.08-0.17	0.08-0.17	0.13-0.25	0.17-0.29	0.21-0.34	0.25-0.38	0.27-0.40
S1	20-40	0.02-0.03	0.02-0.04	0.03-0.06	0.05-0.08	0.07-0.10	0.08-0.12	0.09-0.13	0.10-0.14
S2	20-30	0.02-0.03	0.02-0.04	0.02-0.04	0.04-0.08	0.06-0.10	0.07-0.12	0.08-0.13	0.08-0.14
H1	15-30	0.02-0.03	0.02-0.04	0.02-0.06	0.04-0.08	0.07-0.11	0.07-0.12	0.08-0.12	0.08-0.13

The cutting data indicated are starting values and must be adjusted to the prevailing conditions.
The minimum value should not be less than 30 % of the start value.

In addition to the universal standard portfolio, special tools can also be requested.

Example of EASYDrill Solid

- Solid carbide drills in different versions
- Step drills in different versions

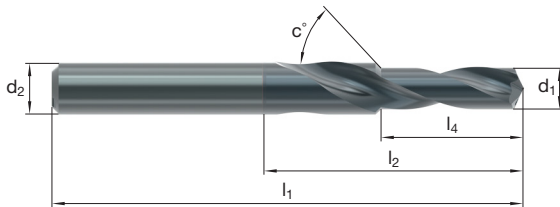

Example of EASYReam Solid

- Solid carbide reamer in different tolerance classes or designs

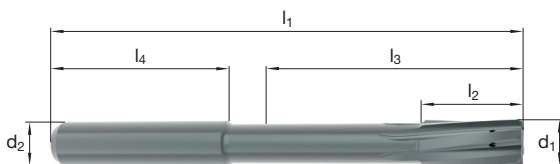

We are committed to you worldwide!
Für any inquiries about our standard program or our special offerings,
please contact us and our experts.

www.lmt-tools.com/en/contact



Full Flexibility For Fine Machining

For the fine machining of a large variety of components, the EASYReam family convinces with its wide range of applications. The solid carbide reamers and modular reamers are available in two versions and can be used easily and flexibly for the finish machining of blind and through holes.

With their internal coolant supply and central or radial outlet, maximum cooling is achieved with the best chip control. The user-friendly handling of the reaming tools shortens the set-up times and applies especially for the modular design.

Our Universal Reaming Program for Various Materials

EASYReam reamers are universally applicable for steel, stainless steel and cast iron. Due to their two cutting material designs, the solid carbide reamers are also suitable for machining non-ferrous metals, such as aluminum. The EASYReam Solid covers the diameter range 5.00 mm to 14.00 mm.

The EASYReam Modular is available with diameters from 14.00 mm to 42.00 mm. Because of the modular holder, fine machining is possible for both blind holes and through holes. A wide range of holders in 8 different sizes and two length versions 3xD and 5xD, offers the right solution for all diameter ranges and applications.

The tools are ground to ISO H7 tolerance class and have minimal runout (< 3 microns).

Your advantages:

- Maximum tool life with outstanding bore quality and surface finish
- Higher cutting speeds and feeds to increase machining speed
- Perfect straightness of the hole with constant hole diameter
- Noticeable reduction in vibrations
- Cost reduction and lower inventory costs

Cutting edge part made of solid carbide can be reground more often

Unequal pitch provides vibration reduction and longer tool life

Lapped cutting edge for high bore and surface quality

Simultaneous contact of the plane and taper surfaces enables high rigidity and concentricity

Easy handling and safe torque transmission due to unique interface

One holder for blind and through holes for variable use

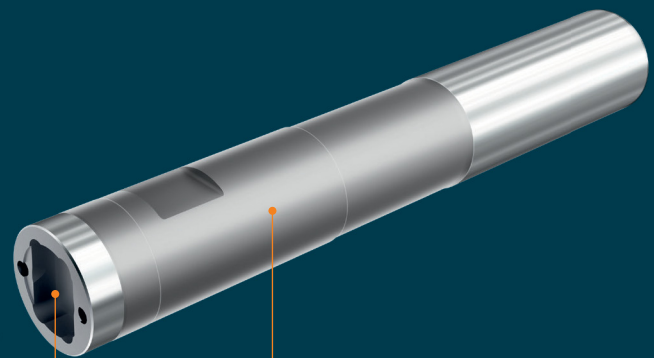



LWN
10F

LCPM
05F

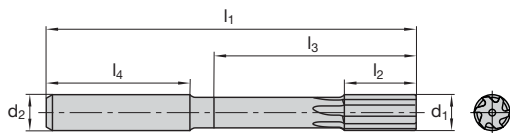

Cat.-No.

RES01-SF

P	<input type="checkbox"/>	<input checked="" type="checkbox"/>
M	<input type="checkbox"/>	<input checked="" type="checkbox"/>
K	<input type="checkbox"/>	<input checked="" type="checkbox"/>
N	<input checked="" type="checkbox"/>	<input type="checkbox"/>
S	<input type="checkbox"/>	<input type="checkbox"/>
H		

d ₁	l ₂	l ₁	l ₃	l ₄	d ₂	z	Ident No.	LMT-Code	Ident No.	LMT-Code
5	12	74	32	36	6	4	7430775	RE-RES01 N05000.H7.SF	7430799	RE-RES01 K05000.H7.SF
5.5	12	74	32	36	6	4	7430776	RE-RES01 N05500.H7.SF	7430800	RE-RES01 K05500.H7.SF
6	12	74	32	36	6	4	7430777	RE-RES01 N06000.H7.SF	7430801	RE-RES01 K06000.H7.SF
6.5	16	91	49	36	8	4	7430778	RE-RES01 N06500.H7.SF	7430802	RE-RES01 K06500.H7.SF
7	16	91	49	36	8	4	7430779	RE-RES01 N07000 H7.SF	7430803	RE-RES01 K07000 H7.SF
8	16	91	49	36	8	6	7430780	RE-RES01 N08000 H7.SF	7430804	RE-RES01 K08000 H7.SF
9	20	103	57	40	10	6	7430781	RE-RES01 N09000 H7.SF	7430805	RE-RES01 K09000 H7.SF
10	20	103	57	40	10	6	7430782	RE-RES01 N10000 H7.SF	7430806	RE-RES01 K10000 H7.SF
11	24	118	67	45	12	6	7430783	RE-RES01 N11000 H7.SF	7430807	RE-RES01 K11000 H7.SF
12	24	118	67	45	12	6	7430784	RE-RES01 N12000 H7.SF	7430808	RE-RES01 K12000 H7.SF
13	28	132	81	45	14	6	7430785	RE-RES01 N13000 H7.SF	7430809	RE-RES01 K13000 H7.SF
14	28	132	81	45	14	6	7430786	RE-RES01 N14000 H7.SF	7430810	RE-RES01 K14000 H7.SF

Cutting data recommendations see page 18

■ = First choice
□ = Alternative

DIN
6535
HA

H7



LWN
10F

LCPM
05F

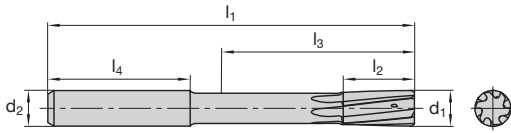

Cat.-No.		RES01-HF									
P			<input type="checkbox"/>								<input checked="" type="checkbox"/>
M			<input type="checkbox"/>								<input checked="" type="checkbox"/>
K			<input type="checkbox"/>								<input checked="" type="checkbox"/>
N			<input checked="" type="checkbox"/>								<input type="checkbox"/>
S			<input type="checkbox"/>								<input type="checkbox"/>
H											
d ₁	l ₂	l ₁	l ₃	l ₄	d ₂	z	Ident No.	LMT-Code	Ident No.	LMT-Code	
5	12	74	32	36	6	4	7430763	RE-RES01 N05000.H7.HF	7430787	RE-RES01 K05000.H7.HF	
5.5	12	74	32	36	6	4	7430764	RE-RES01 N05500.H7.HF	7430788	RE-RES01 K05500.H7.HF	
6	12	74	32	36	6	4	7430765	RE-RES01 N06000.H7.HF	7430789	RE-RES01 K06000.H7.HF	
6.5	16	91	49	36	8	4	7430766	RE-RES01 N06500.H7.HF	7430790	RE-RES01 K06500.H7.HF	
7	16	91	49	36	8	4	7430767	RE-RES01 N07000 H7.HF	7430791	RE-RES01 K07000.H7.HF	
8	16	91	49	36	8	6	7430768	RE-RES01 N08000 H7.HF	7430792	RE-RES01 K08000 H7.HF	
9	20	103	57	40	10	6	7430769	RE-RES01 N09000 H7.HF	7430793	RE-RES01 K09000 H7.HF	
10	20	103	57	40	10	6	7430770	RE-RES01 N10000 H7.HF	7430794	RE-RES01 K10000 H7.HF	
11	24	118	67	45	12	6	7430771	RE-RES01 N11000 H7.HF	7430795	RE-RES01 K11000 H7.HF	
12	24	118	67	45	12	6	7430772	RE-RES01 N12000 H7.HF	7430796	RE-RES01 K12000 H7.HF	
13	28	132	81	45	14	6	7430773	RE-RES01 N13000 H7.HF	7430797	RE-RES01 K13000 H7.HF	
14	28	132	81	45	14	6	7430774	RE-RES01 N14000 H7.HF	7430798	RE-RES01 K14000 H7.HF	

Cutting data recommendations see page 18

■ = First choice
□ = Alternative

Material Group	Cutting speed v_c (m/min)		Tool diameter (mm)		
	Solid carbide		Feed per tooth f_z (mm/z)		
	LWN10F uncoated	LCPM05F coated	Ø 5.0–7.0	Ø 8.0–9.0	Ø 10.0–14.0
	Start/max	Start/max			
P1	65–75	125–165	0.05–0.12	0.05–0.14	0.05–0.16
P2	60–65	105–135	0.05–0.12	0.05–0.14	0.05–0.16
P3	40–45	85–110	0.05–0.12	0.05–0.14	0.05–0.16
M1	10–15	20–30	0.04–0.08	0.04–0.10	0.04–0.12
M2	10–15	20–30	0.04–0.08	0.04–0.10	0.04–0.12
K1	55–65	105–135	0.05–0.18	0.05–0.20	0.05–0.22
K2	35–50	90–110	0.05–0.14	0.05–0.16	0.05–0.18
N	160–200	–	0.06–0.18	0.06–0.20	0.06–0.22
S	10–15	20–30	0.04–0.08	0.04–0.10	0.04–0.12

The cutting data indicated are starting values and must be adjusted to the prevailing conditions.
The minimum value should not be less than 30 % of the start value.

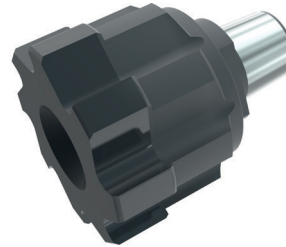
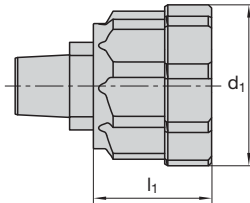

Cat.-No.		REM01-SF			
P					■
M					■
K					■
N					
S					□
H					
d ₁	l ₁	z	Connection part	Ident No.	LMT-Code
14	17.9	6	A	7430700	RE-REM01 14000.H7.SF.A
15	17.9	6	A	7430701	RE-REM01 15000.H7.SF.A
16	17.9	6	B	7430702	RE-REM01 16000.H7.SF.B
17	17.9	6	B	7430703	RE-REM01 17000.H7.SF.B
18	17.9	6	C	7430704	RE-REM01 18000.H7.SF.C
19	17.9	6	C	7430705	RE-REM01 19000.H7.SF.C
20	17.9	6	D	7430706	RE-REM01 20000.H7.SF.D
21	17.9	6	D	7430707	RE-REM01 21000.H7.SF.D
22	17.9	6	D	7430708	RE-REM01 22000.H7.SF.D
23	18.9	6	E	7430709	RE-REM01 23000.H7.SF.E
24	18.9	6	E	7430710	RE-REM01 24000.H7.SF.E
25	18.9	8	E	7430711	RE-REM01 25000.H7.SF.E
26	18.9	8	E	7430712	RE-REM01 26000.H7.SF.E
27	18.9	8	E	7430713	RE-REM01 27000.H7.SF.E
28	18.9	8	F	7430714	RE-REM01 28000.H7.SF.F
29	18.9	8	F	7430715	RE-REM01 29000.H7.SF.F
30	18.9	8	F	7430716	RE-REM01 30000.H7.SF.F
31	18.9	8	F	7430717	RE-REM01 31000.H7.SF.F
32	18.9	8	F	7430718	RE-REM01 32000.H7.SF.F
33	20.4	8	G	7430719	RE-REM01 33000.H7.SF.G
34	20.4	8	G	7430720	RE-REM01 34000.H7.SF.G
35	20.4	8	G	7430721	RE-REM01 35000.H7.SF.G
36	20.4	8	G	7430722	RE-REM01 36000.H7.SF.G
37	20.4	8	G	7430723	RE-REM01 37000.H7.SF.G
38	20.4	8	H	7430724	RE-REM01 38000.H7.SF.H
39	20.4	8	H	7430725	RE-REM01 39000.H7.SF.H
40	20.4	8	H	7430726	RE-REM01 40000.H7.SF.H
41	20.4	8	H	7430727	RE-REM01 41000.H7.SF.H
42	20.4	8	H	7430728	RE-REM01 42000.H7.SF.H

The reaming tool holder is supplied with clamping screw.
Please order reaming tool head separately.

■ = First choice
□ = Alternative

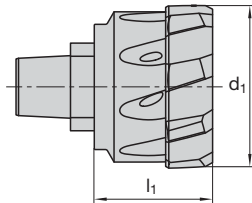

Cat.-No.				REM01-HF	
P					■
M					■
K					■
N					
S					□
H					
d ₁	l ₁	z	Connection part	Ident No.	LMT-Code
14	17.9	6	A	7430729	RE-REM01 14000.H7.HF.A
15	17.9	6	A	7430730	RE-REM01 15000.H7.HF.A
16	17.9	6	B	7430731	RE-REM01 16000.H7.HF.B
17	17.9	6	B	7430732	RE-REM01 17000.H7.HF.B
18	17.9	6	C	7430733	RE-REM01 18000.H7.HF.C
19	17.9	6	C	7430734	RE-REM01 19000.H7.HF.C
20	17.9	6	D	7430735	RE-REM01 20000.H7.HF.D
21	17.9	6	D	7430736	RE-REM01 21000.H7.HF.D
22	17.9	6	D	7430737	RE-REM01 22000.H7.HF.D
23	18.9	6	E	7430738	RE-REM01 23000.H7.HF.E
24	18.9	6	E	7430739	RE-REM01 24000.H7.HF.E
25	18.9	8	E	7430740	RE-REM01 25000.H7.HF.E
26	18.9	8	E	7430741	RE-REM01 26000.H7.HF.E
27	18.9	8	E	7430742	RE-REM01 27000.H7.HF.E
28	18.9	8	F	7430743	RE-REM01 28000.H7.HF.F
29	18.9	8	F	7430744	RE-REM01 29000.H7.HF.F
30	18.9	8	F	7430745	RE-REM01 30000.H7.HF.F
31	18.9	8	F	7430746	RE-REM01 31000.H7.HF.F
32	18.9	8	F	7430747	RE-REM01 32000.H7.HF.F
33	20.4	8	G	7430748	RE-REM01 33000.H7.HF.G
34	20.4	8	G	7430749	RE-REM01 34000.H7.HF.G
35	20.4	8	G	7430750	RE-REM01 35000.H7.HF.G
36	20.4	8	G	7430751	RE-REM01 36000.H7.HF.G
37	20.4	8	G	7430752	RE-REM01 37000.H7.HF.G
38	20.4	8	H	7430753	RE-REM01 38000.H7.HF.H
39	20.4	8	H	7430754	RE-REM01 39000.H7.HF.H
40	20.4	8	H	7430755	RE-REM01 40000.H7.HF.H
41	20.4	8	H	7430756	RE-REM01 41000.H7.HF.H
42	20.4	8	H	7430757	RE-REM01 42000.H7.HF.H

The reaming tool holder is supplied with clamping screw.
Please order reaming tool head separately.

■ = First choice
□ = Alternative

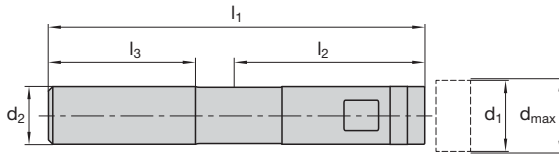

Cat.-No.							REM01		
d ₁	l ₂	l ₁	l ₃	d _{max}	d ₂	Connection part	Ident No.	LMT-Code	
3 x Ø									
14	35	91	48	15	16	A	7430684	RE-REM01 3x16M.A	
16	39	99	51	17	20	B	7430685	RE-REM01 3x20M.B	
18	45	106	51	19	20	C	7430686	RE-REM01 3x20M.C	
20	51.5	113.5	51	22	20	D	7430687	RE-REM01 3x20M.D	
22.5	65.5	130.5	51	27	20	E	7430688	RE-REM01 3x20M.E	
27.5	80.5	152.5	56	32	25	F	7430689	RE-REM01 3x25M.F	
32.5	94	174	61	37	32	G	7430690	RE-REM01 3x32M.G	
37.5	108	190	61	42	32	H	7430691	RE-REM01 3x32M.H	
5 x Ø									
14	67	123	48	15	16	A	7430692	RE-REM01 5x16M.A	
16	75	135	51	17	20	B	7430693	RE-REM01 5x20M.B	
18	85	146	51	19	20	C	7430694	RE-REM01 5x20M.C	
20	96.5	158.5	51	22	20	D	7430695	RE-REM01 5x20M.D	
22.5	120.5	185.5	51	27	20	E	7430696	RE-REM01 5x20M.E	
27.5	145.5	217.5	56	32	25	F	7430697	RE-REM01 5x25M.F	
32.5	169	249	61	37	32	G	7430698	RE-REM01 5x32M.G	
37.5	192	274	61	42	32	H	7430699	RE-REM01 5x32M.H	

The reaming tool holder is supplied with clamping screw.
Please order reaming tool head separately.

Material Group	Cutting speed v_c (m/min)	Tool diameter (mm)		
	Solid carbide Start/max	Feed per tooth f_z (mm/z)		
		\varnothing 14.0–19.0	\varnothing 20.0–32.0	\varnothing 33.0–42.0
P1	125–165	0.10–0.22	0.10–0.24	0.10–0.26
P2	105–135	0.10–0.22	0.10–0.24	0.10–0.26
P3	85–110	0.08–0.18	0.08–0.22	0.08–0.24
M1	20–40	0.08–0.16	0.08–0.18	0.08–0.22
M2	20–30	0.08–0.16	0.08–0.18	0.08–0.22
K1	115–135	0.10–0.22	0.10–0.24	0.10–0.26
K2	85–105	0.10–0.20	0.10–0.22	0.10–0.24
S	20–30	0.06–0.16	0.10–0.18	0.10–0.20

The cutting data indicated are starting values and must be adjusted to the prevailing conditions.
The minimum value should not be less than 30 % of the start value.

Recommended allowance for reaming

Tool diameter	Pre-drilling diameter – Reduction (mm)		
	min	Start	max
4.00–10.00	0.10	0.15	0.25
10.00–15.00	0.15	0.20	0.30
15.00–20.00	0.15	0.25	0.35
20.00–42.00	0.20	0.30	0.40

1. Tighten the screw

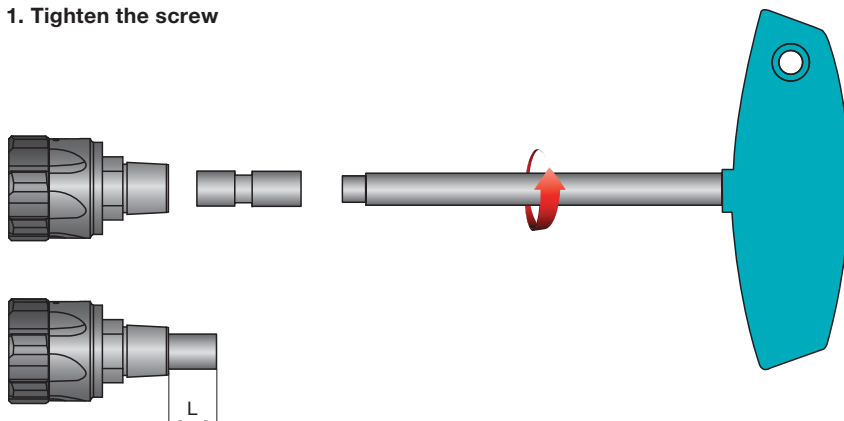

	Ø mm	L (mm)
	14.000	27.499
	27.500	42.000
		5-5.5
		5.5-6

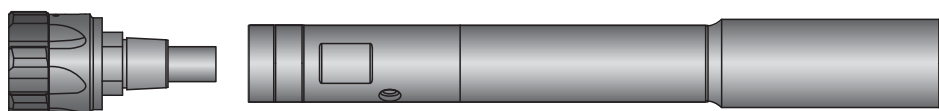

2. Insert the reaming head

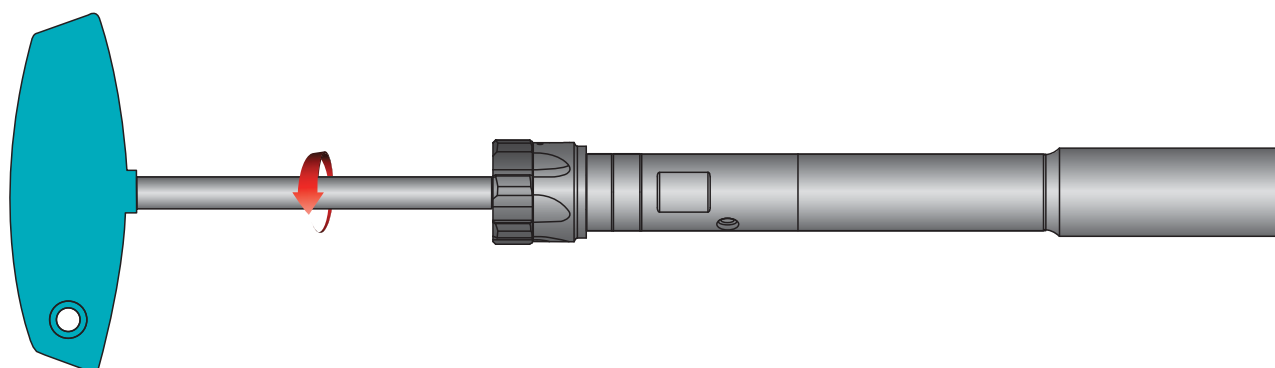

3. Tighten with torque



Torques Modular reamer

Connection part	Diameter mm			Torque in NM
A	14.000-15.999	7430758	T8	2
B	16.000-19.999	7430759	T10	3
C				
D	20.000-27.499	7430760	T15	5
E				
F	27.500-32.499	7430761	T25	9
G	32.500-42.000	7430762	T30	13
H				

U	D	-	E	D	S	0	1	3	x	0	2	5	0	0	M	.	4	H	A
1			2		3			4				5			6		7		8

<p>1 UD = Universal Drill</p> <p>2 Type EDS = Easy Drill Solid EDI = Easy Drill Indexable</p> <p>3 01 = Generation</p> <p>4 Machining depth 3 = 3 x D 5 = 5 x D</p>	<p>5 Cutting diameter in mm (d₁)</p> <p>6 Dimension system M = Metric I = Inch</p> <p>7 Shank diameter in mm (d₂)</p> <p>8 Shank form HA = Straight shank DIN 6535 HA HB = Straight shank DIN 6535 HB</p>
---	---

Explanation LMT-Code
Solid carbide step drill

U	D	-	E	D	S	0	1	3	x	0	2	5	0	0	M	.	0	3	5	x	4	5	.	4	H	A
1			2		3			4				5			6		7		8		9		10			

<p>1 UD = Universal Drill</p> <p>2 Type EDS = Easy Drill Solid</p> <p>3 01 = Generation</p> <p>4 Machining depth 3 = 3 x D 5 = 5 x D</p> <p>5 Cutting diameter in mm (d₁)</p>	<p>6 Dimension system M = Metric I = Inch</p> <p>7 Step diameter in mm (d₃)</p> <p>8 Step angle</p> <p>9 Shank diameter in mm (d₂)</p> <p>10 Shank form HA = Straight shank DIN 6535 HA HB = Straight shank DIN 6535 HB</p>
---	--

R E - R E S 0 1 N 0 5 0 0 0 . H 7 . H F

1 2 3 4 5 6 7

1 RE = Reamer

2 Type
RES = Reamer Solid
REM = Reamer Modular

3 01 = Generation

4 Primary application
P = Steel
M = Stainless steel
K = Cast iron
N = Non-ferrous metals
S = Heat-resistant alloys
H = Hardened steel
U = Universal

5 Cutting diameter in mm (d₁)

6 Tolerance

7 Shank form
HF = Helical fluted
SF = Straight fluted

R E - R E M 0 1 0 5 0 0 0 . H 7 . S F . A

1 2 3 4 5 6 7

1 RE = Reamer

2 Type
RES = Reamer Solid
REM = Reamer Modular

3 01 = Generation

4 Cutting diameter in mm (d_1)

5 Tolerance

6 Shank form
HF = Helical fluted
SF = Straight fluted

7 Connection
A = Connection A
B = Connection B
C = Connection C
D = Connection D
E = Connection E
F = Connection F
G = Connection G
H = Connection H

R E - R E M 0 1 3 x 1 6 M . A
1 2 3 4 5 6 7

1 RE = Reamer

2 Type
RES = Reamer Solid
REM = Reamer Modular

3 01 = Generation

4 Machining depth
3 = 3 x D
5 = 5 x D

5 Shank diameter in mm (d_2)

6 Dimension system
M = Metric
I = Inch

7 Connection
A = Connection A
B = Connection B
C = Connection C
D = Connection D
E = Connection E
F = Connection F
G = Connection G
H = Connection H

LMT has developed a user-oriented grades index for the new LMT cutting material and coating grades to ensure that users always select the correct LMT cutting material for their applications.

This recommendation is based on the internationally used ISO key for workpiece materials.

L C K P 3 0 M 1						
1	2	3	4	5	6	
1	LMT brand					
2	Cutting material					
	A = HSS					
	B = CBN					
	C = Carbide, coated					
	D = PCD					
	E = Monocrystalline diamond					
	T = Cermet					
	W = Carbide, uncoated					
	X = Ceramics					
3	Workpiece material (ISO 513 – Primary and auxiliary application)					
	P = Steel					
	M = Stainless steel					
	K = Cast iron					
	N = Non-ferrous metals					
	S = Heat-resistant alloys					
	H = Hardened steel					
4	Toughness (ISO 513)					
5	Machining					
	B = Boring/Drilling					
	C = Crankshaft					
	D = Tapping/Threading					
	F = Reaming					
	G = Grooving					
	H = High feed geometry					
	M = Milling					
	R = Rolling					
	T = Turning					
6	Version number (optional)					

The previously used grade designations remain valid until further notice.

Example:

LCK10M

L – LMT

 C – Carbide, coated

 K – Cast iron

 10 – Toughness

 M – Milling

Publication details

Publisher: LMT Tools Global Operations GmbH & Co. KG,
Vogesenstrasse 23, 77933 Lahr, Germany, Phone: +49 78 21 943-0
Responsible for the content: Norman Winter, LMT Tool Systems GmbH & Co. KG
Design: deckermedia GbR, Rostock
Printing: Druckerei Weidner GmbH, Rostock



© LMT Tools Global Operations GmbH & Co. KG

This publication may not be reprinted in whole or part without our express permission. All right reserved. No rights may be derived from any errors in content or from typographical or typesetting errors. Diagrams, features and dimensions represent the current status on the date of issue of this catalog. We reserve the right to make technical changes. The visual appearance of the products may not necessarily correspond to the actual appearance in all cases or in every detail.

Sources: LMT Tools Global Operations GmbH & Co. KG und LMT Tool Systems GmbH & Co. KG

