

# Production Cutting Tools

Wood, Plastic, Composite  
Honeycomb, Aluminum

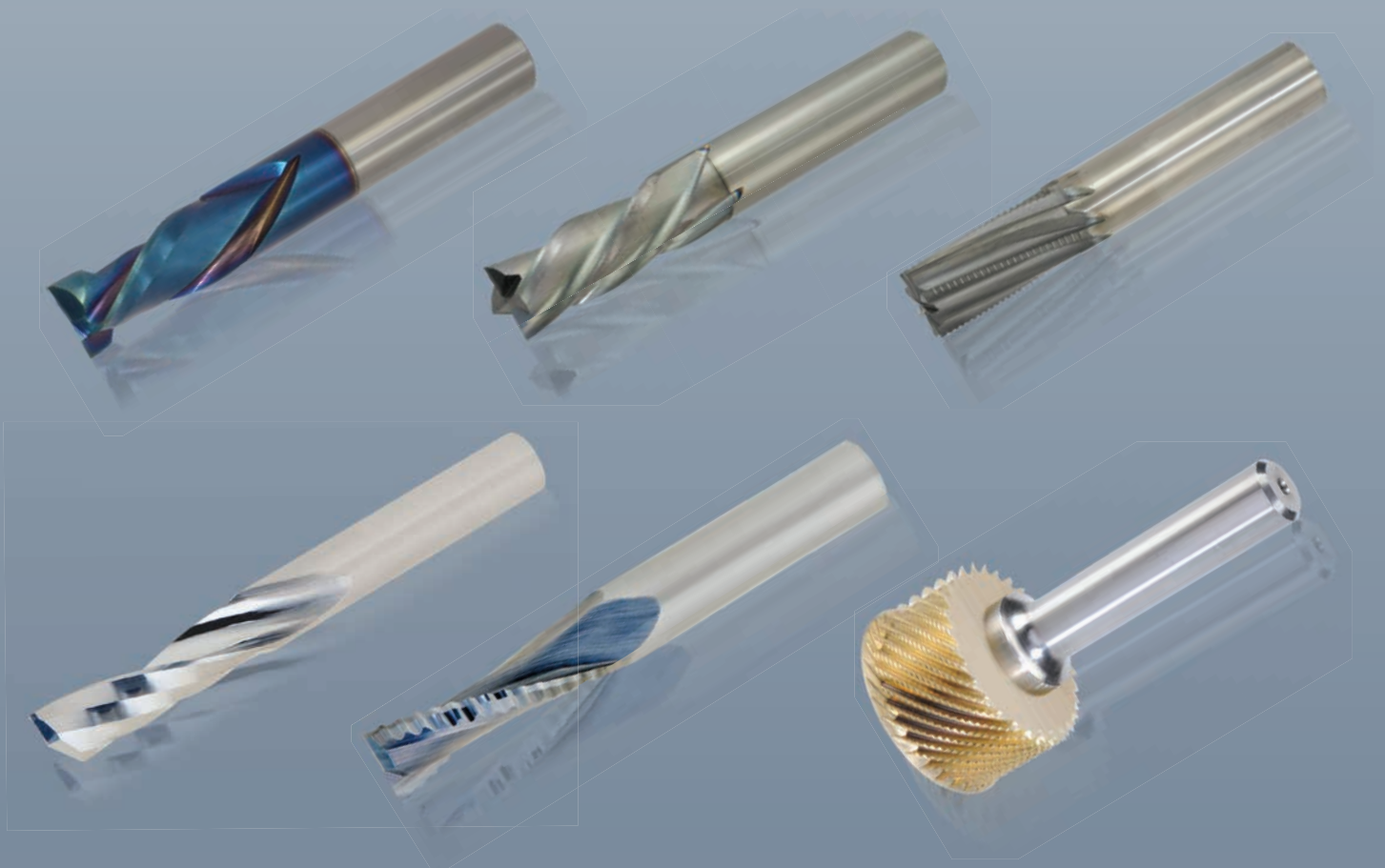

**exactly  
yours**

Since our beginning over 70 years ago, LMT Onsrud has endeavored to innovate and to develop the best cutting tool solutions in the market. LMT Onsrud is recognized as a leading manufacturer of solid round tooling for a wide range of materials from plastics to composites to exotic metals.

Today our promise remains the same—to consistently provide premium cutting tool solutions to meet your needs and to provide exceptional support throughout all phases of planning, development and production.

**Materials Cut:**

- Composites
- Exotic Metals
- Honeycomb
- Non-Ferrous Metals
- Plastics and Acrylics
- Solid Surface
- Stainless Steels
- Wood and Composite Woods

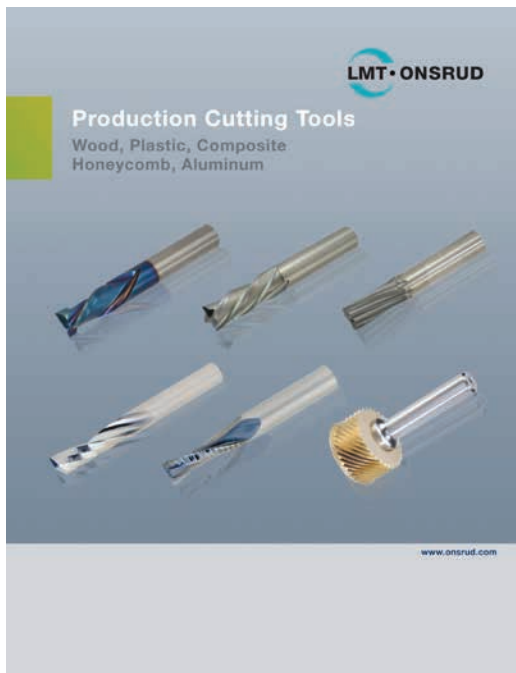

**LMT Onsrud**  
Production Cutting Tools

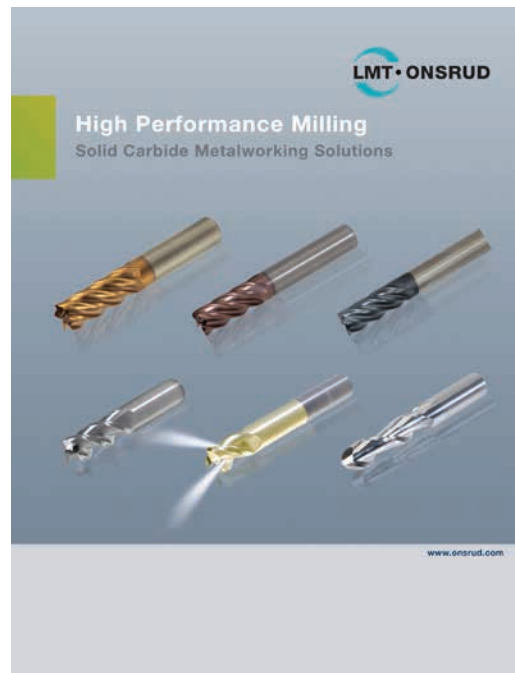

**LMT Onsrud**  
High Performance Milling

This publication may not be reprinted in whole or part without our express permission. All rights reserved. No rights may be derived from any errors in content or from typographical or typesetting errors. Diagrams, features, and dimensions represent the current status on the date of issue of this catalog. We reserve the right to make technical changes. The visual appearance of the products may not necessarily correspond to the actual appearance in all cases or in every detail.

## Contents

### Production Cutting Tools

14	10-00	HSS 1F “O” Flute Straight	39	52-200B/BL	SC 2F Spiral Upcut Ball Nose
14	11-00	HSS 1F & 2F “O” Flute Straight	39	52-400	SC 2F Spiral Upcut Wood Rout - Metric
15	15-40	Compression Dor Bit	40	52-550	SC 2F Foam Cutters
16	15-50	HSS 1F Steel Dor Bit	40	52-600	SC 2F Upcut “O” Flute
16	15-75	HSS 3F CNC Dor Bit	41	52-700	SC 2F Upcut “O” Flute
17	18-00	HSS 1F Straight Pilot	41	52-900	SC 2F Upcut Heavy Duty
17	20-00	HSS 1F Downcut Spiral Pilot	42	54-200	SC 3F & 4F Spiral for Glass Reinforced Plastic
17	20-10	HSS 1F Drywall Bit	43	56-000	SC 2F Straight
18	27-00	SC 1F Laminate Trim	43	56-000P	SC 2F Straight
18	27-50	SC 2F Laminate Trim	44	56-200	SC 2F Straight Wood Rout
18	28-20	SC Double Bearing Plastic Trim	44	56-430	SC 2F Straight “O” Flute - Metric
19	28-50	CT Flush Trim	45	56-450	SC 2F Straight - Metric
19	29-50	CT 2F Straight Chamfer	45	56-600	SC 2F Straight “O” Flute
20	37-00	SC 60° Engraving Tools	46	57-000	SC 2F Downcut Spiral
20	37-20	SC 30° Engraving Tools	46	57-200	SC 2F Downcut Spiral Wood Rout
21	37-50/60	Carbide V Bottom	47	57-200MD	SC 2F Downcut Spiral Marathon Wood Rout
21	37-70	CT Dibond/Alucobond Folding Tool	47	57-400	SC 2F Downcut Spiral Wood Rout - Metric
22	37-80	CT Lettering Bits	48	57-600	SC 2F Downcut “O” Flute
22	40-50	CT Round & Rout	48	57-900	SC 2F Downcut Heavy Duty
23	42-00	CT Straight Corner Round	49	60-000	SC 3F High Helix Chipbreaker
23	47-00	CT MDF Panel Bits	49	60-000	SC 3F Low Helix Chipbreaker
24	90-00	T Slot Cutter	50	60-090	SC 3F Upcut Lock Mortise
24	29-000	HSS Hollow Core Cutters	50	60-100PLR	SC Polaris Compression
25	29-050	Diamond Grit Hogger	51	60-100MC	SC Marathon Compression
26	29-100/ 29-100B	SC Honeycomb Hogger	52	60-100MW	SC Max Life Compression
27	30-000	Replaceable Ring Type Honeycomb Cutter	53	60-100C	SC Chipbreaker/Finisher Compression
28	30-300	HSS Integral Shank Honeycomb Hogger Cutter	54	60-200	SC 3F Low Helix Finisher
28	30-700	Reduced Weight Honeycomb Cutter	55	60-300	SC 2F Chipbreaker Finisher
29	31-000	HSS Cutter	55	60-350	SC 3F Chipbreaker Finisher
29	31-100	HSS Honeycomb Cutter with Teeth	56	60-600	SC 4F High Velocity Compression
30	32-200	HSS 3 Piece Honeycomb Hogger	56	60-700	SC 4F High Velocity Spiral
31	34-000	Aircraft Panel Tools	57	60-800	SC 2F Roughers
32	34-100	Potted Fastener Tool	57	60-900	SC 3F Heavy Duty Hogger
33	40-000	HSS 1F Upcut Spiral	58	60-950	SC 2F Heavy Duty Chipbreaker/Finisher
33	40-000	HSS 1F Downcut Spiral	58	61-000	SC 1F “O” Flute Straight
34	40-100	HSS 2F Upcut Spiral	59	61-000P	SC 1F “O” Flute Straight
34	40-100	HSS 2F Downcut Spiral	60	61-200	SC 1F Straight Wood Rout
35	40-550	HSS 4F Foam Cutters	60	61-400	SC 1F Straight - Metric
35	48-000	CT 1F Straight	60	62-600	SC 1F “O” Flute Downcut Spiral
36	48-000	CT 2F Straight	61	62-700	SC 1F Downcut “O” Flute
37	49-000	HSS 2F Steel Downcut	61	62-750	SC 1F Downcut “O” Flute
37	52-000	SC 2F Spiral Upcut	61	62-800	SC 1F Downcut “O” Flute - Metric
38	52-200	SC 2F Spiral Upcut Wood Rout	61	62-850	SC 1F Downcut “O” Flute - Metric

## Contents

### Production Cutting Tools

62	63-000	SC 1F Upcut Spiral
63	63-200	SC 1F Upcut Spiral Wood Rout
63	63-400	SC 1F Upcut for Soft Aluminum
64	63-500	SC 1F Acrylic Tools
64	63-600	SC 1F "O" Flute Upcut Spiral
65	63-700	SC 1F Upcut "O" Flute
65	63-750	SC 1F Upcut "O" Flute
65	63-800	SC 1F Upcut "O" Flute - Metric
65	63-850	SC 1F Upcut "O" Flute - Metric
66	63-900	SC 1F "O" Flute Upcut Spiral - Metric
66	64-000	SC 1F Downcut Super O
67	65-000	SC 1F Upcut Super O
68	65-200B	SC 2F High Finish Ballnose
68	65-300B	SC 4F High Finish Ballnose
69	66-000	SC Edge Rounding Bits
70	66-200	SC Rout and Chamfer
70	66-300	SC Upcut Bottom Surfacing
71	66-400	SC Honeycomb Compression
72	66-500	DFC Multi Flute Composite Router
73	66-700	DFC Low Helix Finisher - Upcut
74	66-750	DFC Low Helix Cutter
75	66-775	DFC Low Helix Rougher Finisher
75	66-800	DFC Compression
76	66-900	SC High Performance Composite Router
77	67-000	SC Fiberglass Burr Bits
78	67-200	PCD 3F Progressive Chipbreaker
79	67-220	3F Diamond Grit Tools
79	67-250	SC 3F Phenolic Cutter
80	67-400	SC Un-Ruffer™ PATENTED
80	67-500	SC Carbon Graphite Tool
81	67-800	SC 8 Facet Drills
83	68-000	PCD Tipped 2F Tools
83	68-100	PCD 1F Compression
84	68-200	PCD 2F SERF Cutter
84	68-300	PCD 3F SERFIN™ Cutter
85	68-400	PCD 2F Ballnose
85	68-500	PCD Engravers
86	68-900	PCD 8 Facet Drills
87	70-100	CT Blade and Arbor
88	70-200	SC Flush Mount Blade
88	70-300	CT Flush Mount Blade
89	70-500	HSS Plastic Drills
90	72-000	SC Boring Bits
91	77-100	SC 2F & 3F Taper Tools

92	80-000	HSS 3F Taper Pin Router
92	81-000	HSS 2F Lo Helix
93	81-100	SC 2F Extrusion Cutter
93	83-300	SC 2F Stainless Steel Cutter
94	85-800	SC CFRP Drills
95	86-150	DFC Aerospace Composite Drills (ACD)
95	91-000	CT Spoilboard Cutter
95	91-100	Insert Spoilboard Cutter

### Accessories

97	33-00	Fiber Adapter Bushing
97	33-10	Collet Brush Kit
97	33-21	Cleaning Solvent & Rust Protector
98	33-30	Tool Extender
98	33-60	Spindle Taper Wiper
99	33-70	ISO Toolholders for CNC Routers
99	33-80	BT Toolholders for CNC Routers
100	33-90	HSK 63F Toolholders
100	34-50	Collet Life Plug
101	Collets	ER Collets Inch
102	Collets	ER Collets Metric
103	33-110	Pull Studs for CNC Router
103	33-120	Cat 40 Precision Toolholder
104	34-170	HSK63F Hydraulic Holders and Reduction Sleeves
104	34-550	Perske (SYOZ)/DIN6388 Collets & Nuts
105	34-700	Ultra High-Speed ER Coated Nuts
105	34-743	Dust Cover
106	34-750	Hand Wrenches for Collet Nuts
106	34-800	Torque Wrench
107	34-810	Adapter Socket
107	34-820	Pull Stud Socket
107	34-850	Collet Keys for Torque Wrenches
108	34-920	ER Dust Seal Nuts and Dust Seal
108	34-950	Spindle Drill Adapters

### Technical Information

See Page 109-131

Tool Image	Series #	Name	Page Number	SW	HW	CW	CW	LW	SP	HP	SSP	FP	A	CP	HC	CM/DW	D	M	
				Soft Wood	Hard Wood	Plywood	MDF	Laminated Wood	Soft Plastic	Hard Plastic	Solid Surface	Foam	Aluminum	Composite	Honeycomb	Construction Material	Metal Doors	Metal	Accessories
	10-00	HSS 1F "O" Flute Straight	14	☐					☐										
	11-00	HSS 1F & 2F "O" Flute Straight	14						☐	☐									
	15-40	Compression Dor Bit	15															■	
	15-50	HSS 1F Steel Dor Bit	16															■	
	15-75	HSS 3F CNC Dor Bit	16															■	
	18-00	HSS 1F Straight Pilot	17															■	
	20-00	HSS 1F Downcut Spiral Pilot	17															■	
	20-10	HSS 1F Drywall Bit	17															■	
	27-00	SC 1F Laminate Trim	18					☐											
	27-50	SC 2F Laminate Trim	18					☐											
	28-20	SC Double Bearing Plastic Trim	18						☐	☐									
	28-50	CT Flush Trim	19	☐	☐		☐	☐	☐										
	29-50	CT 2F Straight Chamfer	19	☐	☐		☐												
	33-00	Fiber Adapter Bushing	97																■
	33-10	Collet Brush Kit	97																■
	33-21	Cleaning Solvent & Rust Protector	97																■
	33-30	Tool Extender	98																■
	33-60	Spindle Taper Wiper	98																■
	33-70	ISO Toolholders for CNC Routers	99																■
	33-80	BT Toolholders for CNC Routers	99																■
	33-90	HSK 63F Toolholders for CNC Routers	100																■

■ = First Choice ☐ = Second Choice

Tool Image	Series #	Name	Page Number	SW	HW	CW	CW	LW	SP	HP	SSP	FP	A	CP	HC	CM DW	D	M	
				Soft Wood	Hard Wood	Plywood	MDF	Laminated Wood	Soft Plastic	Hard Plastic	Solid Surface	Foam	Aluminum	Composite	Honeycomb	Construction Material	Metal Doors	Metal	Accessories
	34-50	Collet Life Plug	100																■
	Collets	ER Collets Inch	101																■
	Collets	ER Collets Metric	102																■
	37-00	SC 60° Engraving Tools	20	☐	☐				☐	☐	☐	☐	☐						
	37-20	SC 30° Engraving Tools	20	☐	☐				☐	☐	☐		☐						
	37-50/60	Carbide V Bottom	21	☐	☐	☐	☐	☐	☐	☐	☐								
	37-70	CT Dibond/Alucobond Folding Tool	21										☐						
	37-80	CT Lettering Bits	22	☐	☐	☐	☐	☐											
	40-50	CT Round & Rout	22	☐	☐	☐	☐		☐	☐	☐								
	42-00	CT Straight Corner Round	23	☐	☐		☐				☐								
	47-00	CT MDF Panel Bits	23				☐												
	90-00	T Slot Cutter	24	☐	☐	☐	☐												
	29-000	HSS Hollow Core Cutters	24													■			
	29-050	Diamond Grit Hogger	25													■			
	29-100/ 29-100B	SC Honeycomb Hogger	26													■			
	30-000	Replaceable Ring Type Honeycomb Cutter	27													■			
	30-300	HSS Integral Shank Honeycomb Hogger Cutter	28													■			
	30-700	Reduced Weight Honeycomb Cutter	28													■			
	31-000	HSS Cutter	29													■			
	31-100	HSS Honeycomb Cutter with Teeth	29													■			
	32-200	HSS 3 Piece Honeycomb Hogger	30													■			

■ = First Choice ☐ = Second Choice

Tool Image	Series #	Name	Page Number	SW	HW	CW	CW	LW	SP	HP	SSP	FP	A	CP	HC	CM/DW	D	M	
				Soft Wood	Hard Wood	Plywood	MDF	Laminated Wood	Soft Plastic	Hard Plastic	Solid Surface	Foam	Aluminum	Composite	Honeycomb	Construction Material	Metal Doors	Metal	Accessories
	33-110	Pull Studs for CNC Router	103																■
	33-120	Cat 40 Precision Toolholder	103																■
	34-000	Aircraft Panel Tools	31												■				
	34-100	Potted Fastener Tool	32												■				
	34-170	HSK63F Hydraulic Holders and Reduction Sleeves	104																■
	34-550	Perske (SYOZ)/DIN6388 Collets & Nuts	104																■
	34-700	Ultra High-Speed ER Coated Nuts	105																■
	34-743	Dust Cover	105																■
	34-750	Hand Wrenches for Collet Nuts	106																■
	34-800	Torque Wrench	106																■
	34-810	Adapter Socket	107																■
	34-820	Pull Stud Socket	107																■
	34-850	Collet Keys for Torque Wrenches	107																■
	34-920	ER Dust Seal Nuts and Dust Seal	108																■
	34-950	Spindle Drill Adapters	108																■
	40-000	HSS 1F Upcut Spiral	33	□	□								□						
	40-000	HSS 1F Downcut Spiral	33	□	□								□						
	40-100	HSS 2F Upcut Spiral	34	□	□								□						
	40-100	HSS 2F Downcut Spiral	34	□	□								□						
	40-550	HSS 4F Foam Cutters	35									■							
	48-000	CT 1F Straight	35		□	□	□	□					□						

■ = First Choice □ = Second Choice

Tool Image	Series #	Name	Page Number	SW	HW	CW	CW	LW	SP	HP	SSP	FP	A	CP	HC	CM	D	M	
				Soft Wood	Hard Wood	Plywood	MDF	Laminated Wood	Soft Plastic	Hard Plastic	Solid Surface	Foam	Aluminum	Composite	Honeycomb	Construction Material	Metal Doors	Metal	Accessories
	48-000	CT 2F Straight	36		☐	☐	☐	☐											
	49-000	HSS 2F Steel Downcut	37											☐					
	52-000	SC 2F Spiral Upcut	37								☐		☐						
	52-200	SC 2F Spiral Upcut Wood Rout	38	■	■	☐	■												
	52-200B/BL	SC 2F Spiral Upcut Ball Nose	39	☐	☐	☐	☐		☐	☐	☐		☐						
	52-400	SC 2F Spiral Upcut Wood Rout-Metric	39	■	■	☐	■												
	52-550	SC 2F Foam Cutters	40									■							
	52-600	SC 2F Upcut "O" Flute	40						☐	■	■								
	52-700	SC 2F Upcut "O" Flute	41	☐	☐				■		■	☐							
	52-900	SC 2F Upcut Heavy Duty	41	☐	☐	☐	☐												
	54-200	SC 3F & 4F Spiral for Glass Reinforced Plastic	42												■				
	56-000	SC 2F Straight	43							■									
	56-000P	SC 2F Straight	43							☐	■	☐		☐					
	56-200	SC 2F Straight Wood Rout	44	☐	☐	☐	☐												
	56-430	SC 2F Straight "O" Flute-Metric	44						☐	☐									
	56-450	SC 2F Straight-Metric	45							☐	☐			☐					
	56-600	SC 2F Straight "O" Flute	45						■	☐									
	57-000	SC 2F Downcut Spiral	46											☐	☐				
	57-200	SC 2F Downcut Spiral Wood Rout	46	■	■	☐	■	☐											
	57-200MD	SC 2F Downcut Spiral Marathon Wood Rout	47	■	■	☐	■	☐											
	57-400	SC 2F Downcut Spiral Wood Rout-Metric	47	■	■		■												

■ = First Choice ☐ = Second Choice



Tool Image	Series #	Name	Page Number	SW	HW	CW	CW	LW	SP	HP	SSP	FP	A	CP	HC	CM/DW	D	M	Accessories
				Soft Wood	Hard Wood	Plywood	MDF	Laminated Wood	Soft Plastic	Hard Plastic	Solid Surface	Foam	Aluminum	Composite	Honeycomb	Construction Material	Metal Doors	Metal	
	57-600	SC 2F Downcut "O" Flute	48						<input type="checkbox"/>	<input type="checkbox"/>	<input type="checkbox"/>								
	57-900	SC 2F Downcut Heavy Duty	48	<input type="checkbox"/>	<input type="checkbox"/>		<input type="checkbox"/>												
	60-000	SC 3F High Helix Chipbreaker	49	<input type="checkbox"/>	<input type="checkbox"/>	<input checked="" type="checkbox"/>	<input type="checkbox"/>		<input type="checkbox"/>	<input type="checkbox"/>									
	60-000	SC 3F Low Helix Chipbreaker	49	<input type="checkbox"/>	<input type="checkbox"/>	<input checked="" type="checkbox"/>	<input type="checkbox"/>		<input type="checkbox"/>	<input type="checkbox"/>									
	60-090	SC 3F Upcut Lock Mortise	50	<input type="checkbox"/>	<input type="checkbox"/>	<input type="checkbox"/>	<input type="checkbox"/>												
	60-100PLR	SC Polaris Compression	50	<input type="checkbox"/>	<input type="checkbox"/>	<input checked="" type="checkbox"/>	<input type="checkbox"/>	<input checked="" type="checkbox"/>											
	60-100MC	SC Marathon Compression	51	<input type="checkbox"/>	<input type="checkbox"/>	<input checked="" type="checkbox"/>	<input type="checkbox"/>	<input checked="" type="checkbox"/>											
	60-100MW	SC Max Life Compression	52	<input type="checkbox"/>	<input type="checkbox"/>	<input checked="" type="checkbox"/>	<input type="checkbox"/>	<input checked="" type="checkbox"/>											
	60-100C	SC Chipbreaker/Finisher Compression	53	<input type="checkbox"/>	<input type="checkbox"/>	<input checked="" type="checkbox"/>	<input type="checkbox"/>	<input type="checkbox"/>											
	60-200	SC 3F Low Helix Finisher	54	<input type="checkbox"/>	<input type="checkbox"/>		<input type="checkbox"/>			<input type="checkbox"/>	<input type="checkbox"/>								
	60-300	SC 2F Chipbreaker Finisher	55	<input type="checkbox"/>	<input checked="" type="checkbox"/>	<input type="checkbox"/>	<input type="checkbox"/>												
	60-350	SC 3F Chipbreaker Finisher	55	<input type="checkbox"/>	<input checked="" type="checkbox"/>	<input type="checkbox"/>	<input type="checkbox"/>												
	60-600	SC 4F High Velocity Compression	56	<input type="checkbox"/>	<input type="checkbox"/>	<input checked="" type="checkbox"/>	<input type="checkbox"/>	<input checked="" type="checkbox"/>											
	60-700	SC 4F High Velocity Spiral	56	<input type="checkbox"/>	<input type="checkbox"/>	<input type="checkbox"/>	<input type="checkbox"/>												
	60-800	SC 2F Roughers	57	<input type="checkbox"/>	<input type="checkbox"/>	<input type="checkbox"/>	<input type="checkbox"/>												
	60-900	SC 3F Heavy Duty Hogger	57	<input type="checkbox"/>	<input type="checkbox"/>	<input type="checkbox"/>	<input type="checkbox"/>		<input type="checkbox"/>	<input type="checkbox"/>									
	60-950	SC 2F Heavy Duty Chipbreaker/Finisher	58	<input type="checkbox"/>	<input checked="" type="checkbox"/>	<input type="checkbox"/>	<input type="checkbox"/>												
	61-000	SC 1F "O" Flute Straight	58	<input type="checkbox"/>									<input type="checkbox"/>						
	61-000P	SC 1F "O" Flute Straight	59						<input type="checkbox"/>	<input type="checkbox"/>									
	61-200	SC 1F Straight Wood Rout	60	<input type="checkbox"/>	<input type="checkbox"/>	<input type="checkbox"/>	<input type="checkbox"/>												
	61-400	SC 1F Straight-Metric	60						<input type="checkbox"/>	<input type="checkbox"/>									

■ = First Choice    □ = Second Choice

Tool Image	Series #	Name	Page Number	SW	HW	CW	CW	LW	SP	HP	SSP	FP	A	CP	HC	CM	D	M
				Soft Wood	Hard Wood	Plywood	MDF	Laminated Wood	Soft Plastic	Hard Plastic	Solid Surface	Foam	Aluminum	Composite	Honeycomb	Construction Material	Metal Doors	Metal
	62-600	SC 1F "O" Flute Downcut Spiral	60										■					
	62-700	SC 1F Downcut "O" Flute	61							■	□							
	62-750	SC 1F Downcut "O" Flute	61						■	□	□							
	62-800	SC 1F Downcut "O" Flute-Metric	61							■	□							
	62-850	SC 1F Downcut "O" Flute-Metric	61						■	□	□							
	63-000	SC 1F Upcut Spiral	62										□	□				
	63-200	SC 1F Upcut Spiral Wood Rout	63	□	□	□	□											
	63-400	SC 1F Upcut for Soft Aluminum	63										□					
	63-500	SC 1F Acrylic Tools	64						■	■								
	63-600	SC 1F "O" Flute Upcut Spiral	64										■					
	63-700	SC 1F Upcut "O" Flute	65							■	□							
	63-750	SC 1F Upcut "O" Flute	65						■	□	□							
	63-800	SC 1F Upcut "O" Flute-Metric	65							■	□							
	63-850	SC 1F Upcut "O" Flute-Metric	65						■	□	□							
	63-900	SC 1F "O" Flute Upcut Spiral-Metric	65										■					
	64-000	SC 1F Downcut Super O	66	■	□	□	□		■	■	■		■					
	65-000	SC 1F Upcut Super O	67	■	□	□	□		■	■	■		■					
	65-200B	SC 2F High Finish Ballnose	68						□									
	65-300B	SC 4F High Finish Ballnose	68						□									
	66-000	SC Edge Rounding Bits	69					□	□	□	□							
	66-200	SC Rout and Chamfer	70						□	□								

■ = First Choice □ = Second Choice

Tool Image	Series #	Name	Page Number	SW	HW	CW	CW	LW	SP	HP	SSP	FP	A	CP	HC	CM/DW	D	M
				Soft Wood	Hard Wood	Plywood	MDF	Laminated Wood	Soft Plastic	Hard Plastic	Solid Surface	Foam	Aluminum	Composite	Honeycomb	Construction Material	Metal Doors	Metal
	66-300	SC Upcut Bottom Surfacing	70						<input type="checkbox"/>	<input type="checkbox"/>			<input type="checkbox"/>					
	66-400	SC Honeycomb Compression	71												<input checked="" type="checkbox"/>			
	66-500	DFC Multi Flute Composite Router	72											<input checked="" type="checkbox"/>				
	66-700	DFC Low Helix Finisher-Upcut	73											<input checked="" type="checkbox"/>				
	66-750	DFC Low Helix Cutter	74											<input checked="" type="checkbox"/>				
	66-775	DFC Low Helix Rougher Finisher	75											<input checked="" type="checkbox"/>				
	66-800	DFC Compression	75											<input checked="" type="checkbox"/>				
	66-900	SC High Performance Composite Router	76											<input checked="" type="checkbox"/>				
	67-000	SC Fiberglass Burr Bits	77											<input type="checkbox"/>				
	67-200	SC 3F Phenolic Cutter	78											<input checked="" type="checkbox"/>				
	67-220	PCD 3F Progressive Chipbreaker	79											<input type="checkbox"/>				
	67-250	3F Diamond Grit Tools	79											<input type="checkbox"/>				
	67-400	SC Un-Ruffer™ Patented	80											<input type="checkbox"/>				
	67-500	SC Carbon Graphite Tool	80											<input type="checkbox"/>				
	67-800	SC 8 Facet Drills	81						<input type="checkbox"/>	<input type="checkbox"/>				<input type="checkbox"/>				
	68-000	PCD Tipped 2F Tools	83											<input checked="" type="checkbox"/>				
	68-100	PCD 1F Compression	83	<input type="checkbox"/>	<input type="checkbox"/>	<input type="checkbox"/>	<input type="checkbox"/>	<input checked="" type="checkbox"/>										
	68-200	PCD 2F SERF Cutter	84											<input checked="" type="checkbox"/>				
	68-300	PCD 3F SERFIN™ Cutter	84											<input type="checkbox"/>				
	68-400	PCD 2F Ballnose	85											<input type="checkbox"/>				
	68-500	PCD Engravers	85										<input type="checkbox"/>	<input type="checkbox"/>				

■ = First Choice    □ = Second Choice

Tool Image	Series #	Name	Page Number	SW	HW	CW	CW	LW	SP	HP	SSP	FP	A	CP	HC	CM DW	D	M	
				Soft Wood	Hard Wood	Plywood	MDF	Laminated Wood	Soft Plastic	Hard Plastic	Solid Surface	Foam	Aluminum	Composite	Honeycomb	Construction Material	Metal Doors	Metal	Accessories
	68-900	PCD 8 Facet Drills	86											<input type="checkbox"/>					
	70-100	CT Blade and Arbor	87						<input type="checkbox"/>	<input type="checkbox"/>									
	70-200	SC Flush Mount Blade	88						<input type="checkbox"/>	<input type="checkbox"/>									
	70-300	CT Flush Mount Blade	88						<input type="checkbox"/>	<input type="checkbox"/>									
	70-500	HSS Plastic Drills	89						<input type="checkbox"/>	<input type="checkbox"/>									
	72-000	SC Boring Bits	90	<input type="checkbox"/>	<input type="checkbox"/>	<input type="checkbox"/>	<input type="checkbox"/>	<input type="checkbox"/>											
	77-100	SC 2F & 3F Taper Tools	91	<input type="checkbox"/>	<input type="checkbox"/>	<input type="checkbox"/>	<input type="checkbox"/>		<input type="checkbox"/>	<input type="checkbox"/>		<input type="checkbox"/>	<input type="checkbox"/>						
	80-000	HSS 3F Taper Pin Router	92										<input type="checkbox"/>						
	81-000	HSS 2F Lo Helix	92										<input type="checkbox"/>						
	81-100	SC 2F Extrusion Cutter	93										<input type="checkbox"/>						
	83-300	SC 2F Stainless Steel Cutter	93															<input checked="" type="checkbox"/>	
	85-800	SC CFRP Drills	94											<input type="checkbox"/>					
	86-150	DFC Aerospace Composite Drills (ACD)	95											<input type="checkbox"/>					
	91-000	CT Spoilboard Cutter	95				<input type="checkbox"/>												
	91-100	Insert Spoilboard Cutter	95				<input type="checkbox"/>		<input type="checkbox"/>	<input type="checkbox"/>			<input type="checkbox"/>						

■ = First Choice    □ = Second Choice

# Production Cutting Tools

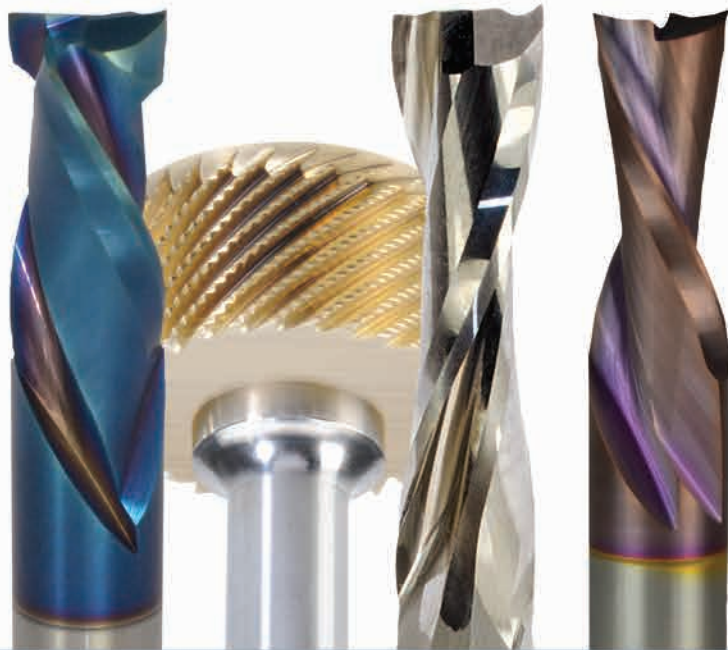

LMT Onsrud has been challenging materials for over 70 years. As materials have changed so has LMT Onsrud's geometry and product diversification.

We take pride in manufacturing tooling for CNC routers and CNC machining centers. Wood, Plastic, Aluminum, Composites, Honeycomb, natural and man-made materials – LMT Onsrud has a solution.

# 10-00 Series O Flute Straight

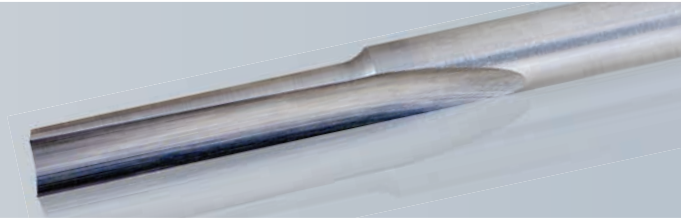

HSS SW SP

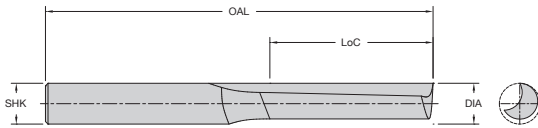

Combines an open flute design with single flute geometry to provide optimum chip removal at fast feed rates. Excellent for hand-fed operations.

10-00 Series O Flute <b>Straight</b> Product Offering					
Part Number	Cutting DIA (in)	LoC (in)	SHK DIA (in)	OAL (in)	Flutes
10-00	1/16	3/16	1/4	2	1
10-01	3/32	3/8	1/4	2	1
10-02	1/8	3/8	1/4	2	1
10-20	1/8	1/2	1/4	2	1
10-22	3/16	3/4	1/4	2	1
10-07	1/4	1	1/4	2-3/8	1
10-78	1/4	1-1/4	1/4	2-5/8	1

# 11-00 Series O Flute Straight



HSS HP SP

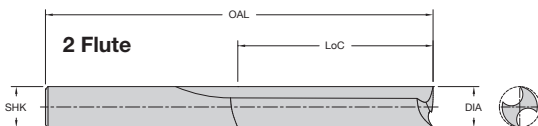
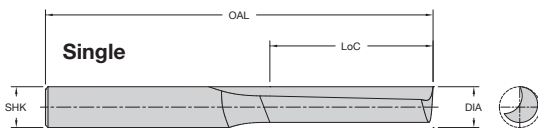

Designed for cutting softer more flexible plastics. Single flute for faster feed rates. Double flute for smoother finish. Excellent for hand-fed operations.

11-00 Series Single Flute - High Speed Steel O Flute <b>Straight</b> Product Offering					
Part Number	Cutting DIA (in)	LoC (in)	SHK DIA (in)	OAL (in)	Flutes
11-01	1/8	1/2	1/4	2	1
11-75*	1/8	5/8	1/4	3-1/4	1
11-77*	3/16	3/4	1/4	3-1/4	1
11-71*	1/4	3/4	1/4	3-1/4	1
11-07	1/4	1	1/4	2-3/8	1
11-09	3/8	1	3/8	2-1/2	1

11-00 Series Two Flute - High Speed Steel O Flute <b>Straight</b> Product Offering					
Part Number	Cutting DIA (in)	LoC (in)	SHK DIA (in)	OAL (in)	Flutes
11-00	3/16	5/8	1/4	2	2
11-02	1/4	3/4	1/4	2-1/8	2
11-72*	1/4	3/4	1/4	3-1/4	2
11-76*	1/4	3/4	1/4	3-3/4	2
11-04	1/4	1	1/4	2-3/8	2
11-78*	1/4	2	1/4	3-1/4	2
11-74*	3/8	1	3/8	3-1/2	2

\*These tools are designed and tolerated for Air Routers with guide bushing.

# 15-40 Series Compression Dor Bits

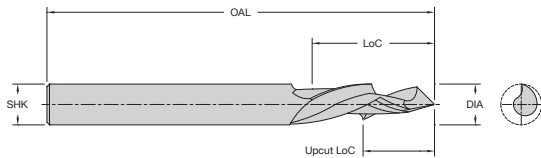
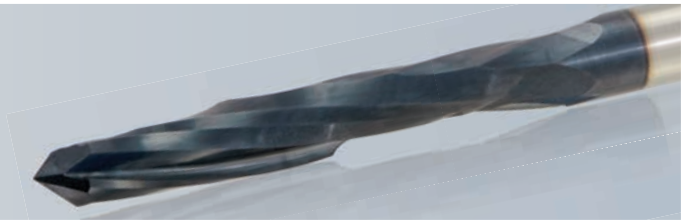

15-40 Series High Speed Steel Compression Dor Bit Product Offering						
Part Number	Cutting DIA (in)	LoC (in)	Upcut LoC (in)	SHK DIA (in)	OAL (in)	Flutes
15-43	1/2	2- 1/2	1.067	1/2	5-1/2	1
15-47*	1/2	2-1/2	1.067	1/2	5-1/2	1

\*With FLAT

LMT Onsrud has long been the leader and innovator of compression tooling for composite woods and laminates. LMT Onsrud is now offering this same technology within our line of high speed steel dor-bits design specifically for routing metal clad doors. Made of high speed steel, these bits reduce the frayed edges on the top and bottom of the cut producing a clean finish. Tools are ESG coated for longer tool life!

### Features and Benefits

- Upcut and downcut compression flutes reduce material fraying.
- Single flute design allows for rapid chip removal.
- ESG coated for increased tool life.

# 15-50 Series Dor-Bits

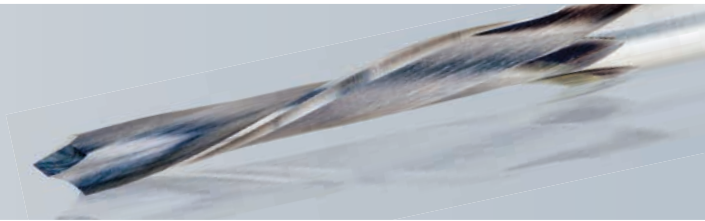

HSS

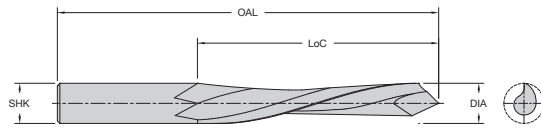

Designed to rout steel doors.

15-50 Series Single Flute - High Speed Steel Dor-Bits Product Offering						
Part Number	Cutting DIA (in)	LoC (in)	SHK DIA (in)	OAL (in)	Door Machine	Flutes
15-52	1/2	2-1/4	1/2	5-1/4	RUVO	1
15-53	1/2	2-1/2	1/2	5-1/2	RUVO	1
15-54	1/2	2-1/2	1/2	5	ACE	1
15-55*	1/2	2-1/2	1/2	5-1/2	FALCON	1
15-57*	1/2	2-1/2	1/2	5-1/2	NORFIELD	1
15-60	1/2	2-1/2	1/2	5-1/2	RUVO	1
15-61*	1/2	2-1/2	1/2	5-1/2		1

HELIX ANGLE  $\approx 18^\circ - 32^\circ$

\*HAVE FLATS

TiN COATED 15-50 Series Single Flute - High Speed Steel Dor-Bits Product Offering						
Part Number	Cutting DIA (in)	LoC (in)	SHK DIA (in)	OAL (in)	Door Machine	Flutes
TiN15-52	1/2	2-1/4	1/2	5-1/4	RUVO	1
TiN15-53	1/2	2-1/2	1/2	5-1/2	RUVO	1
TiN15-54	1/2	2-1/2	1/2	5	ACE	1
TiN15-55*	1/2	2-1/2	1/2	5-1/2	FALCON	1
TiN15-57*	1/2	2-1/2	1/2	5-1/2	NORFIELD	1
TiN15-60	1/2	2-1/2	1/2	5-1/2	RUVO	1
TiN15-61*	1/2	2-1/2	1/2	5-1/2		1

\*HAVE FLATS

# 15-75 Series TiN Coated CNC Dor-Bits



HSS

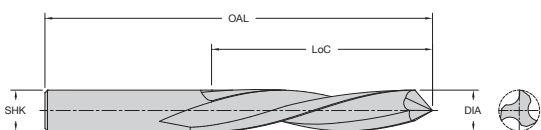

Downcut tools designed specifically for machining metal clad doors in a CNC environment. The tool geometry facilitates piercing steel and produces a superior cut for door lites and hardware openings.

15-75 Series High Speed Steel TiN Coated CNC Dor-Bits Product Offering						
Part Number	Cutting DIA (in)	LoC (in)	SHK DIA (in)	OAL (in)	Door Machine	Flutes
TiN15-75	1/2	3	1/2	6	KVAL	3

HELIX ANGLE  $\approx 18^\circ$



## 18-00 Series Straight Pilot

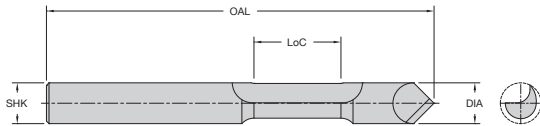

Straight flute tools with boring points and pilots are the workhorse of the mobile home, modular home and RV industries.

18-00 Series Single Flute - High Speed Steel **Straight Pilot** Product Offering

Part Number	Cutting DIA (in)	LoC (in)	SHK DIA (in)	OAL (in)	Flutes
18-00	1/4	3/4	1/4	2-3/4	1
18-02	3/8	7/8	3/8	2-7/8	1

## 20-00 Series Downcut Spiral Pilot

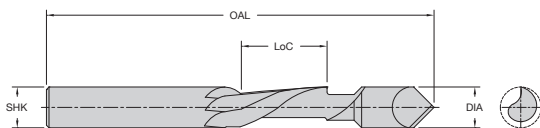

Spiral tools designed to push chips away from the operator in mobile home and RV manufacturing plants.

20-00 Series Single Flute - High Speed Steel **Downcut Spiral Pilot** Product Offering

Part Number	Cutting DIA (in)	LoC (in)	SHK DIA (in)	OAL (in)	Flutes
20-00	1/4	3/4	1/4	3	1
20-02	3/8	1	3/8	3-7/16	1
20-03	1/2	1-1/4	1/2	4	1

HELIX ANGLE  $\approx 21^\circ - 38^\circ$

## 20-10 Series Drywall Bit

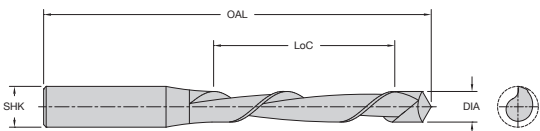
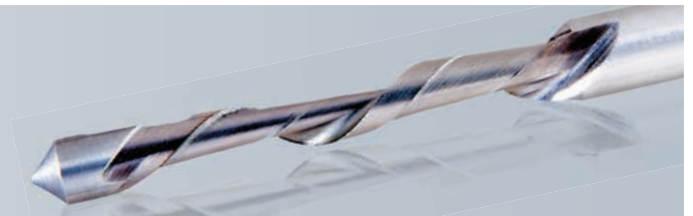

Spiral flute tools designed to make cut outs in drywall. Used in manufactured housing and on site construction.

20-10 Series Single Flute - High Speed Steel **Drywall Bit** Product Offering

Part Number	Cutting DIA (in)	LoC (in)	SHK DIA (in)	OAL (in)	Flutes
20-10	3/16	1	1/4	3-1/4	1
20-11	1/8	3/4	1/8	2-1/2	1
20-15	1/8	1	1/8	2-1/2	1

HELIX ANGLE  $\approx 30^\circ - 41^\circ$

## 27-00 Series Laminate Trim

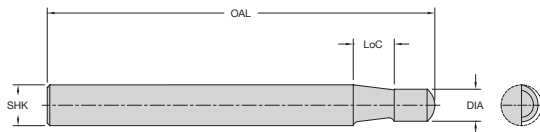
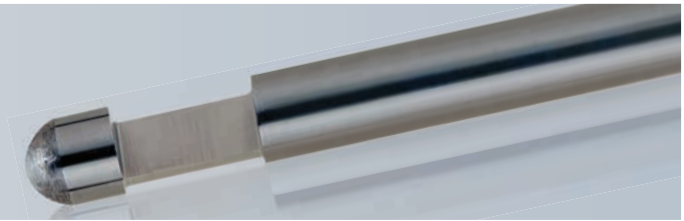

Designed to trim counter tops. The pilot bears on the finished surface and acts as a guide to trim flush or with a bevel.

27-00 Series Single Flute - Solid Carbide Laminate Trim Product Offering

Part Number	Cutting DIA (in)	LoC (in)	SHK DIA (in)	OAL (in)	Style	Flutes
27-00	1/4	1/4	1/4	1-1/2	Flush	1
27-01	1/4	1/4	1/4	1-1/2	7° Bevel	1
27-03	1/4	3/8	1/4	2	Flush	1

## 27-50 Series Laminate Trim

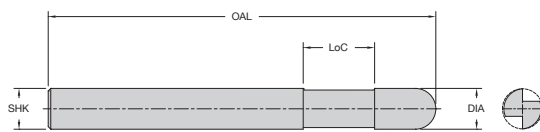
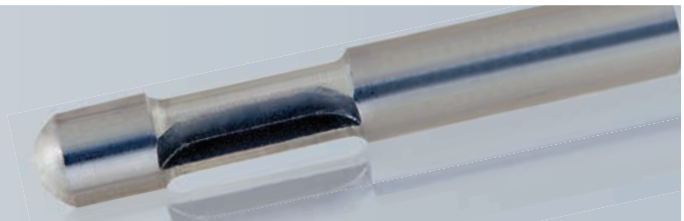

Tools with a pilot designed to give a satin smooth finish when trimming laminate counter tops.

27-50 Series Two Flute - Solid Carbide Laminate Trim Product Offering

Part Number	Cutting DIA (in)	LoC (in)	SHK DIA (in)	OAL (in)	Style	Flutes
27-50	1/4	7/16	1/4	1-5/8	Flush	2

## 28-20 Series Double-Bearing Plastic Trim

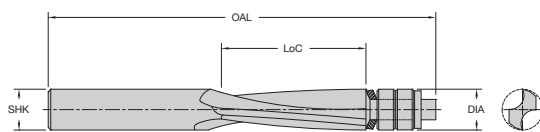
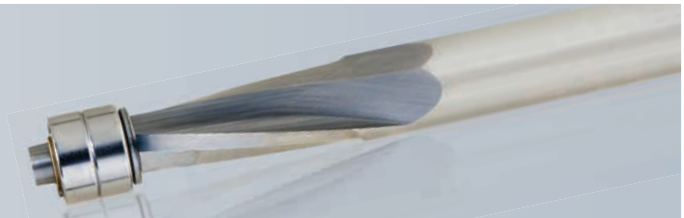

Spirals designed to trim stacked sheets of plastic in hand-fed applications. They use a double bearing guide to ensure smooth cutting action around a template.

28-20 Series Solid Carbide Double-Bearing Plastic Trim Product Offering

Part Number	Cutting DIA (in)	LoC (in)	SHK DIA (in)	OAL (in)	Flutes
28-20	1/4	3/4	1/4	3	2
28-25	1/2	1-1/8	1/2	4	2

HELIX ANGLE  $\approx 11^\circ - 30^\circ$

REPLACEMENT BEARING KITS FOR SERIES 28-20  
Solid Carbide Double Bearing Plastic Trim Tool Kits

28-89	KIT for 28-20 Tool
28-88	KIT for 28-25 Tool

## 28-50 Series Flush Trim

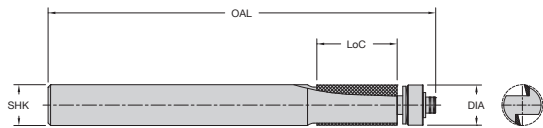
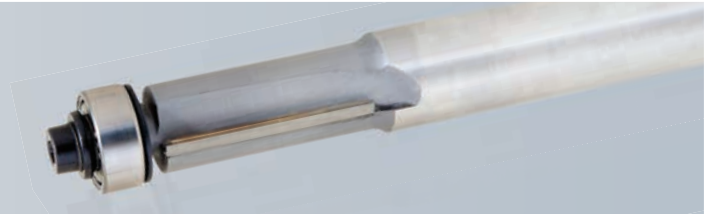

Designed to provide a smooth finished edge on dense, abrasive and laminated materials. A ball bearing guide assists free cutting action. Excellent for hand-fed applications.

28-50 Series Carbide Tipped Flush Trim Product Offering					
Part Number	Cutting DIA (in)	LoC (in)	SHK DIA (in)	OAL (in)	Flutes
28-55	1/4	1	1/4	2-1/2	2
28-51	3/8	1/2	1/4	2-1/4	2
28-50	3/8	1	1/4	2-3/4	2
28-53	1/2	1/2	1/4	2	2
28-57	1/2	1	1/4	2-3/4	3
28-54	1/2	1	1/2	3-1/4	2
28-63	1/2	1-1/2	1/2	4-1/4	2
28-64	1/2	2	1/2	4-1/4	2

REPLACEMENT BEARING KITS FOR SERIES 28-50 <i>Solid Carbide Double Bearing Plastic Trim Tool Kits</i>	
28-80	KIT for 1/4" Cutting Dia
28-79	KIT for 3/8" Cutting Dia
28-78	KIT for 1/2" Cutting Dia

## 29-50 Series Chamfer

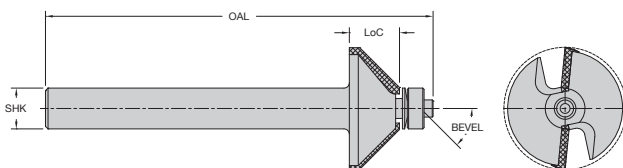
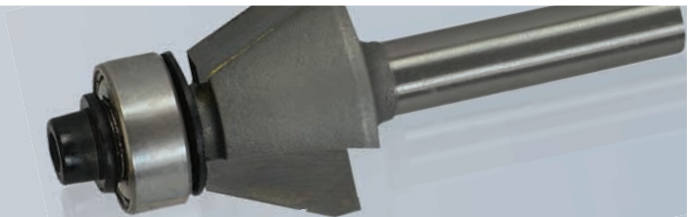

Provides a beveled or decorative edge on finished parts.

29-50 Series Two Flute Carbide Tipped Chamfer Product Offering					
Part Number	Bevel	LoC (in)	SHK DIA (in)	OAL (in)	Flutes
29-51	45°	1/2	1/4	2	2
29-52	45°	1/2	1/2	2-1/2	2
29-53	25°	3/8	1/4	1-7/8	2

# 37-00 & 37-20 Series Engraving Tools

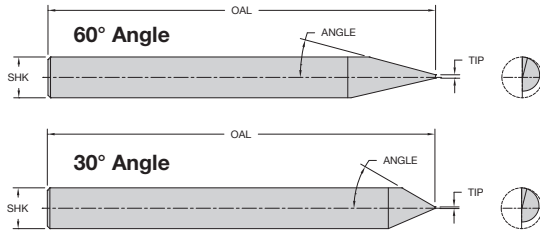
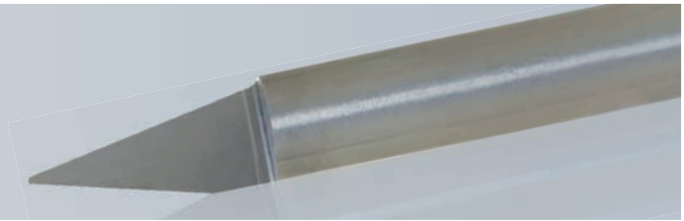

The half round engraving tools are offered with a wide range of tip sizes and angles to accommodate many engraving styles.

37-00 Series Single Flute - Solid Carbide Engraving Tools Product Offering					
Part Number	TIP	Angle	SHK DIA (in)	OAL (in)	Flutes
37-01	0.005	60	1/4	2	1
37-03	0.010	60	1/4	2	1
37-05	0.020	60	1/4	2	1
37-07	0.030	60	1/4	2	1
37-09	0.040	60	1/4	2	1
37-11	0.060	60	1/4	2	1
37-15	0.090	60	1/4	2	1
37-19	60 Degree Kit				

37-00 Series Single Flute - Solid Carbide Engraving Tools Product Offering - Metric					
Part Number	TIP (mm)	Angle	SHK DIA (mm)	OAL (mm)	Flutes
37-05M	0.5	60	6	50	1
37-07M	0.76	60	6	50	1
37-09M	1	60	6	50	1

37-20 Series Single Flute - Solid Carbide Engraving Tools Product Offering					
Part Number	TIP	Angle	SHK DIA (in)	OAL (in)	Flutes
37-21	0.005	30	1/4	2	1
37-23	0.010	30	1/4	2	1
37-25	0.020	30	1/4	2	1
37-27	0.030	30	1/4	2	1
37-29	0.040	30	1/4	2	1
37-31	0.060	30	1/4	2	1
37-35	0.090	30	1/4	2	1
37-39	30 Degree Kit				

37-20 Series Single Flute - Solid Carbide Engraving Tools Product Offering - Metric					
Part Number	TIP (mm)	Angle	SHK DIA (mm)	OAL (mm)	Flutes
37-25M	0.5	30	6	50	1
37-27M	0.76	30	6	50	1
37-29M	1	30	6	50	1

# 37-50 & 37-60 Series V Bottom

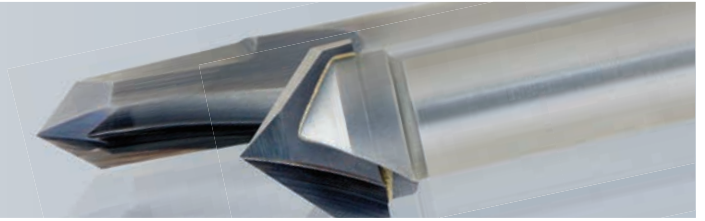

- SC
- CT
- 
- SW
- HW
- CW
- SP
- HP
- SSP
- LW

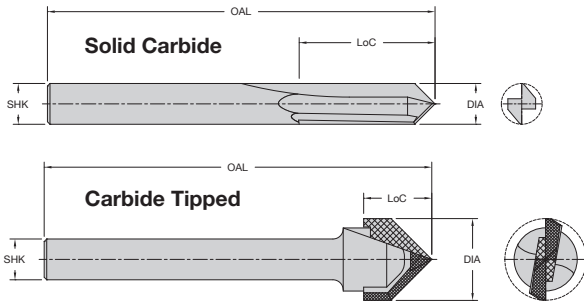

Designed for V grooving or beveling 90°.

### 37-50 Series Two Flute - V Bottom (Solid Carbide) Product Offering

Part Number	Cutting DIA (in)	LoC (in)	SHK DIA (in)	OAL (in)	Flutes
37-50	3/16	5/8	1/4	2	2
37-51	1/4	3/4	1/4	2	2
37-52	3/8	3/4	3/8	2-1/2	2

HELIX ANGLE ≈ 3° - 5° Shear

### 37-60 Series Two Flute - V Bottom (Carbide Tipped) Product Offering

Part Number	Cutting DIA (in)	LoC (in)	SHK DIA (in)	OAL (in)	Flutes
37-61	1/2	13/32	1/4	1-25/32	2
37-62	3/4	1/2	1/2	2-1/8	2
37-63	1	27/32	1/2	2-27/32	2

# 37-70 Series Folding Tool



- CT
- 
- A

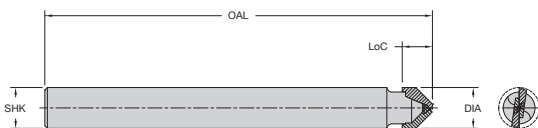

Designed for cutting aluminum/plastic sandwich materials with 90° angle and flat bottom.

90° angle and .090 flat for folding material



### 37-70 Series Two Flute - V Bottom (Carbide Tipped) Product Offering

Part Number	Cutting DIA (in)	LoC (in)	SHK DIA (in)	OAL (in)	Flutes
37-71	1/2	3/8	1/4	2	2
37-72	1/2	3/8	1/2	2	2

## 37-80 Series Lettering Bits

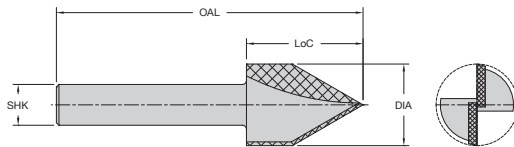
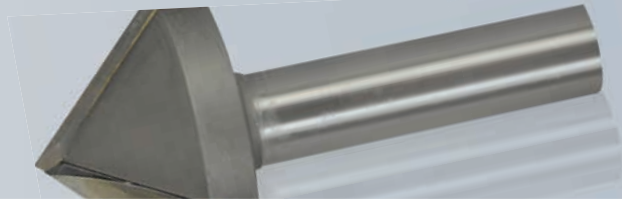

Designed for V grooving or beveling edges of parts. The tools are designed to cut a wide variety of wood products and produce a clean edge.

37-80 Series Two Flute - Carbide Tipped Lettering Bits Product Offering

Part Number	Cutting DIA (in)	LoC (in)	SHK DIA (in)	OAL (in)	ANGLE	Flutes
37-82	1	0.856	1/2	3-1/2	60°	2
37-87	1-1/2	0.750	1/2	3	90°	2
37-92	2	0.577	1/2	3	120°	2
37-97	2	0.363	1/2	2-5/8	140°	2

## 40-50 Series Round & Rout

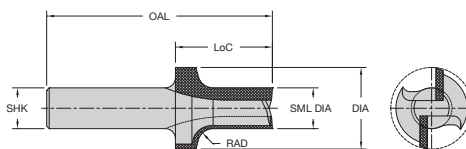

Designed to put a radius on the edge and dress the stock. They will provide a smooth finish.

40-50 Series Two Flute - Carbide Tipped Lettering Bits Product Offering

Part Number	Cutting DIA (in)	Sm Cutting DIA (in)	LoC (in)	SHK DIA (in)	OAL (in)	RAD (in)	Material Thickness	Flutes
40-50	1	1/2	.938	1/2	3-3/16	3/16	3/4	2
40-52	1-1/8	1/2	.937	1/2	3-3/16	1/4	3/4	2
40-54	1-3/8	1/2	.938	1/2	3-3/16	3/8	3/4	2
40-55	1-3/8	1/2	1.437	1/2	3-11/16	3/8	1-3/8	2

# 42-00 Series Corner Round

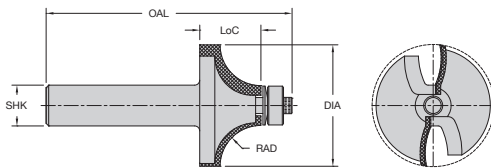

Quarter round profile tools feature up shear geometry for better finishes.

42-00 Series Two Flute - Carbide Tipped Corner Round Product Offering						
Part Number	Radius	Cutting DIA (in)	LoC (in)	SHK DIA (in)	OAL (in)	Flutes
42-10	1/8	3/4	3/8	1/4	2-1/8	2
42-03	5/32	13/16	15/32	1/4	2-3/32	2
42-01	3/16	7/8	1/2	1/4	2	2
42-02	1/4	1	7/16	1/4	1-29/32	2
42-04	5/16	1-1/8	9/16	1/4	2-1/4	2
42-05	3/8	1-1/4	5/8	1/4	2-1/32	2
42-06	1/2	1-1/2	3/4	1/4	2-5/32	2
42-07	1/2	1-1/2	3/4	1/2	2-11/16	2
42-08	3/4	2	1-1/32	1/2	3	2

# 47-00 Series MDF Panel Tools

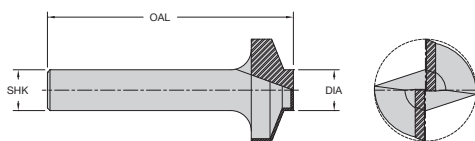

These cutters can create 12 cabinet combinations by combining different stile and panel cutters to get the desired shape in MDF material.

47-00 Series Two Flute - Carbide Tipped MDF Panel Tools Product Offering					
Part Number	Cutting DIA (in)	SHK DIA (in)	OAL (in)	Description	Flutes
47-02	7/8	1/2	2-1/2	Bead Profile - Stile Bits	2
47-04	1-1/4	1/2	2-1/2	Traditional Profile - Stile Bits	2
47-06	1-1/4	1/2	2-1/2	Ogee Profile - Stile Bits	2
47-08	1-1/4	1/2	2-1/2	Straight Profile - Stile Bits	2
47-10	1-1/2	1/2	2-1/2	Cove Profile - Panel Bits	2
47-12	1-1/2	1/2	2-1/2	Straight Profile - Panel Bits	2
47-14	1-1/2	1/2	2-1/2	Ogee Profile - Panel Bits	2

### TOOL COMBINATIONS

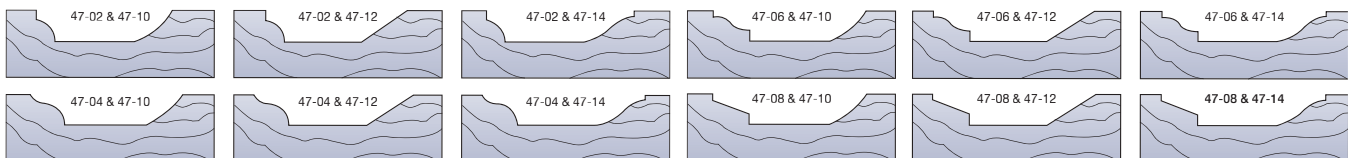

## 90-00 Series T Slot Cutter

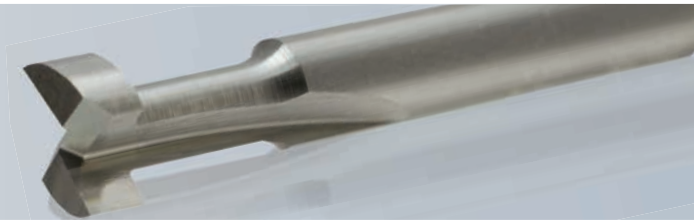

Designed to bore a hole and rout a T shape slot for plaques and frames to provide for built in wall mounting capabilities.

90-00 Series Two Flute T Slot Cutter Product Offering

Part Number	Cutting DIA (in)	LoC (in)	Neck (in)	SHK DIA (in)	OAL (in)	Flutes
90-06	3/8	3/8	3/16	1/4	1-5/8	2

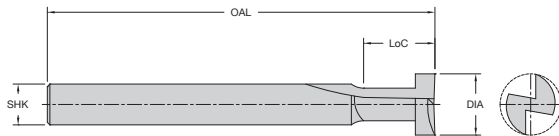

## 29-000 Series Hollow Core Cutters

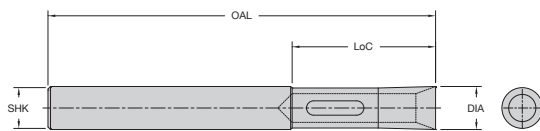
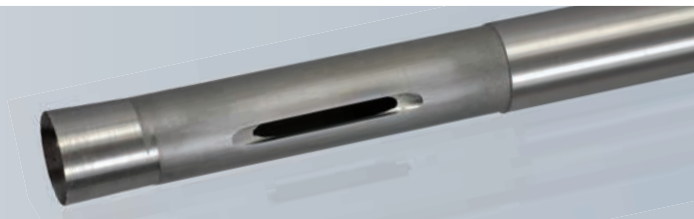

This specialized cutter is designed to vertically cut the honeycomb cells producing a clean, flag free edge. The core material will remain attached at the bottom and can be removed using one of our valve style honeycomb cutters. This product along with our 31-100 or 30-000 series tools is an effective combination to create pockets in honeycomb core and get a perfectly clean edge.

29-000 Series HSS Hollow Core Cutters Product Offering

Part Number	Cutting DIA (in)	LoC (in)	SHK DIA (in)	OAL (in)	Flutes
29-003	1/4	1-1/2	1/4	3-3/4	-
29-006	3/8	1-7/8	3/8	3-3/4	-
29-009	1/2	2-7/8	1/2	5	-
29-012	5/8	2-7/8	5/8	5	-
29-015	3/4	2-7/8	3/4	5	-



# 29-050 Series Diamond Grit Hogger

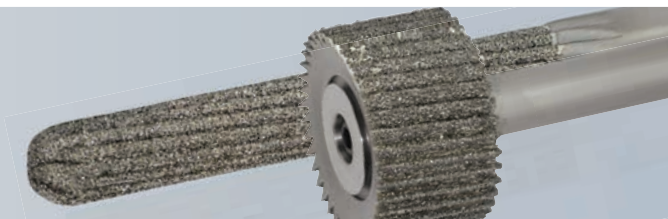

DIA  
grit

HC

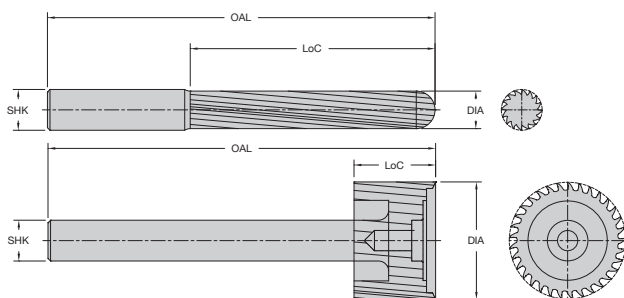

Diamond grit hoggers are used on abrasive cores (graphite, phenolic, or fiberglass) in order to achieve long tool life. The tools are available in a ball nose version and as a traditional hogger capable of holding honeycomb blades. A 35% weight reduction has been designed into the larger diameter tools resulting in better performance on 3 or 5 axis machines.

**Note:** 30% - 50% max radial engagement.

**Note:** Cutting blades sold separately.

29-050 Series Diamond Grit Hogger Product Offering (Ball Nose)

Part Number	Cutting DIA (in)	LoC (in)	SHK DIA (in)	OAL (in)
29-053	1/4	1-1/4	1/4	4
29-058	3/8	2-1/2	1/2	4
29-063	1/2	3	1/2	5
29-068	3/4	3	1/2	5
29-074	1	2	3/4	4

29-050 Series Diamond Grit Hogger Product Offering (Ball Nose) - Metric

Part Number	Cutting DIA (mm)	LoC (mm)	SHK DIA (mm)	OAL (mm)
29-054	6	32	6	100
29-056	10	60	10	120
29-061	12	75	12	120
29-065	20	75	20	120

Honeycomb Hogger					Cutting Blade Options								Spare Parts	
Part Number	Cutting DIA	Hogger Depth	SHK DIA	OAL	Blade Diameter	HSS	HSS w/Teeth	Solid Carbide	Solid Carbide w/Teeth	Diamond Plated	HSS Saw	Adapter Ring	Screw	
29-052	1/4 (6.35mm)	1-1/4	1/4	4	-	-	-	-	-	-	-	-	-	
29-057	.345 (8.76mm)	2-1/2	1/2	4	3/8 (9.52mm)	30-016	30-316	-	-	-	-	-	HRD51646	
29-062	.470 (11.94mm)	3	1/2	5	1/2 (12.7mm)	30-017	30-317	-	-	-	-	-	HRD51646	
29-067	.720 (18.28mm)	3	1/2	5	3/4 (19.05mm)	-	-	30-015	30-318	-	-	-	30-011-2	
29-072	.970 (24.63mm)	1	1/2	3	1 (25.4mm)	-	-	30-012	30-313	30-113	30-213	-	30-011-2	
29-073	.970 (24.63mm)	2	3/4	5	1 (25.4mm)	-	-	30-012	30-313	30-113	30-213	-	30-011-2	
29-078	1.470 (37.33mm)	1	1/2	3	1 1/2 (38.10mm)	-	-	30-014	30-314	30-114	30-214	30-020-3	30-020-4	
29-079	1.470 (37.33mm)	2	3/4	5	1 1/2 (38.10mm)	-	-	30-014	30-314	30-114	30-214	30-020-3	30-020-4	
29-083	1.742 (44.24mm)	1	1/2	3	1.772 (45mm)	-	-	30-026	30-326	30-126 <sup>1</sup>	30-226	30-020-3	30-020-4	
29-084	1.742 (44.24mm)	2	3/4	5	1.772 (45mm)	-	-	30-026	30-326	30-126 <sup>1</sup>	30-226	30-020-3	30-020-4	
29-088	1.970 (50.03mm)	1	5/8	3	2 (50.8mm)	-	-	30-022	30-322	30-122	30-222	30-020-3	30-020-4	
29-089	1.970 (50.03mm)	2	3/4	5	2 (50.8mm)	-	-	30-022	30-322	30-122	30-222	30-020-3	30-020-4	
29-093	2.450 (62.23mm)	1	5/8	3	2.480 (63mm)	-	-	30-036	30-336	30-136	30-236	30-030-3	30-030-4	
29-095	2.970 (75.43mm)	1	3/4	3	3 (76.20mm)	-	-	30-032	30-332	30-132	30-232	30-030-3	30-030-4	
29-096	2.970 (75.43mm)	1	3/4	4	3 (76.20mm)	-	-	30-032	30-332	30-132	30-232	30-030-3	30-030-4	
29-098	3.970 (100.83mm)	1	3/4	3	4 (101.6mm)	-	-	30-042	30-342	30-142	30-242	30-040-3	30-040-4	
29-099	3.970 (100.83mm)	1	3/4	4	4 (101.6mm)	-	-	30-042	30-342	30-142	30-242	30-040-3	30-040-4	

1 = 50mm diameter honeycomb blade

See Page 27 For Images Of Cutting Blades

# 29-100/29-100B Series Hogger

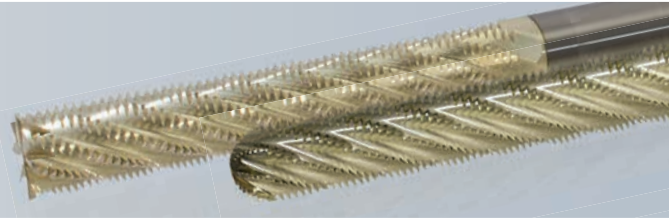

SC ZRN HC

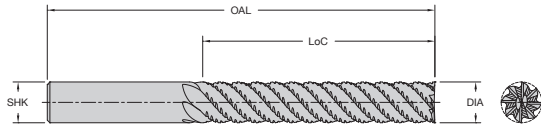

Designed to be a versatile tool and cut most honeycomb core materials. The solid carbide body offers long tool life while the proven hogger geometry shreds the core and evacuates chips. The long flute length allows for deep pocket applications and can also be used to surface large areas. Hoggers are coated with ZRN.

29-100 Series Diamond Grit Hogger Solid Carbide Honeycomb Hogger Product Offering - Metric				
Part Number	Cutting DIA (mm)	LoC (mm)	SHK DIA (mm)	OAL (mm)
29-120	12 (.472")	60	12	150
29-135	16 (.629")	80	16	150

29-100 Series Diamond Grit Hogger Solid Carbide Honeycomb Hogger Product Offering				
Part Number	Cutting DIA (in)	LoC (in)	SHK DIA (in)	OAL (in)
29-110	1/4 (6.35mm)	1-1/4	1/4	4
29-115	3/8 (9.52mm)	2	3/8	4
29-125	1/2 (12.7mm)	3	1/2	6
29-130	1/2 (12.7mm)	4-1/2	1/2	6-1/2
29-140	3/4 (19.05mm)	3	3/4	6
29-145	3/4 (19.05mm)	4-1/2	3/4	6-1/2

29-100B Series Diamond Grit Hogger Solid Carbide Honeycomb Hogger Ballnose Product Offering				
Part Number	Cutting DIA (in)	LoC (in)	SHK DIA (in)	OAL (in)
29-130B	1/2 (12.7mm)	4-1/2	1/2	6-1/2
29-140B	3/4 (19.05mm)	3	3/4	6
29-145B	3/4 (19.05mm)	4-1/2	3/4	6-1/2

\*B = Ballnose

# 30-000 Series Replaceable Ring Type Cutter



HSS

HC

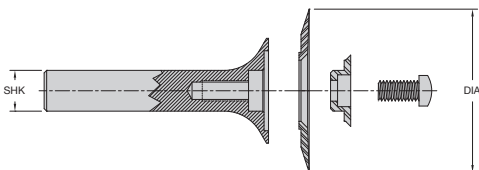

These tools are for contouring, carving and chamfering cuts of .25" or less. The unique patented holding system prevents the solid carbide blades from coming out of the holder if it is fractured.

The HSS saw blades and the diamond plated blades dish on the bottom so they clear the cut core finish like the hollow ground solid carbide style rings. The solid carbide rings may be reground several times at LMT Onsrud making them very economical to use.

The HSS saw and diamond plated blades are disposable, offering the convenience of a constant diameter. **Note:** Cutting blades sold separately

Shank Assembly			Cutting Blade Options				Spare Parts	
Part Number	Blade Diameter	SHK DIA	Solid Carbide	Solid Carbide w/Teeth	Diamond Plated	HSS Saw	Adapter Ring	Screw
30-011	1" (25.4mm)	1/2	30-012	30-313	30-112	30-213	-	30-011-2
30-021	2" (50.8mm)	1/2	30-022	30-322	30-122	30-222	30-020-3	30-020-4
30-031	3" (76.2mm)	1/2	30-032	30-332	30-132	30-232	30-030-3	30-030-4
30-041	4" (101.6mm)	1/2	30-042	30-342	30-142	30-242	30-040-3	30-040-4

Shank Assembly - Metric			Cutting Blade Options - Metric				Spare Parts - Metric	
Part Number	Blade Diameter	SHK DIA	Solid Carbide	Solid Carbide w/Teeth	Diamond Plated	HSS Saw	Adapter Ring	Screw
30-010	25	12	30-052	-	30-115	30-215	-	30-011-2
30-013	45	12	30-026	30-326	30-126	30-226	30-020-3	30-020-4
30-023	63	12	30-036	30-336	30-136	30-236	30-030-3	30-030-4

## Cutting Blades for Cutters and Hoggers

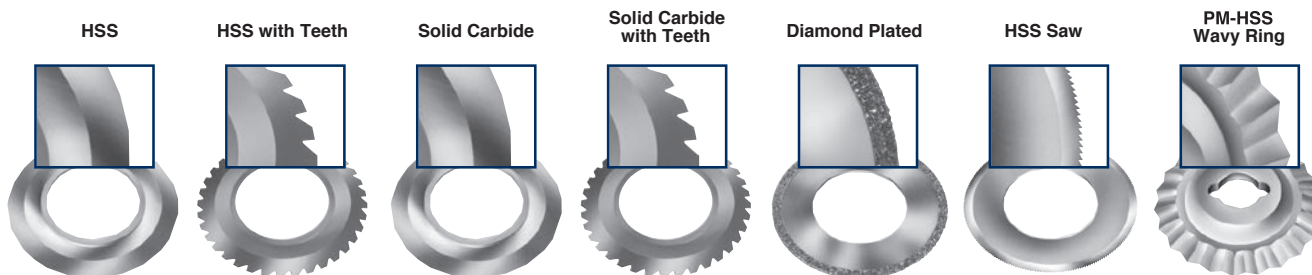

# 30-300 Series Integral Shank Hogger Cutter



HSS HC

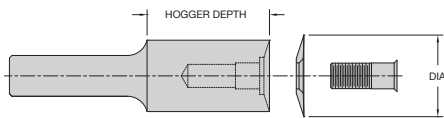

The spiral hogger geometry ground integral to the shank allows for faster feed rates and deeper cuts than any previous cutter. The availability of several different blades makes this cutter suitable for most core types. The hogger design also imparts less force as it evacuates and shreds scrap.

**Note:** Cutting blades sold separately.

Honeycomb Hogger					Cutting Blade Options					Spare Parts	
Part Number	Cutting DIA	Hogger Depth	SHK DIA	OAL	Blade Diameter	Solid Carbide	Solid Carbide w/Teeth	Diamond Plated	HSS Saw	Adapter Ring	Screw
30-310	7/8 (22.22mm)	1-1/2	1/2	3-1/2	1 (25.4mm)	30-012	30-313	30-113	30-213	-	30-011-2
30-315	1-1/4 (31.75mm)	1-1/2	1/2	3-1/2	1-1/2 (38.1mm)	30-014	30-314	30-114	30-214	30-020-3	30-020-4
30-321	1-3/4 (44.45mm)	1-1/2	1/2	3-1/2	2 (50.8mm)	30-022	30-322	30-122	30-222	30-020-3	30-020-4
30-331	2-3/4 (69.85mm)	1	1/2	3-1/2	3 (76.2mm)	30-032	30-332	30-132	30-232	30-030-3	30-030-4
30-341	3-3/4 (95.25mm)	1	3/4	3-1/2	4 (101.6mm)	30-042	30-342	30-142	30-242	30-040-3	30-040-4

See page 27 for Images of Cutting Blades

# 30-700 Series Reduced Weight Cutter

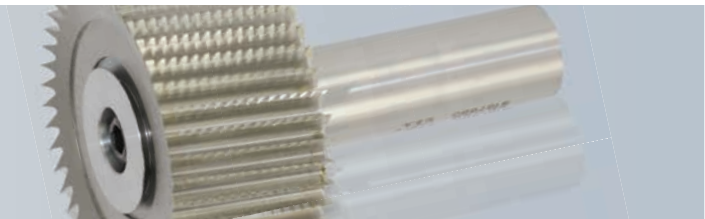

HSS HC

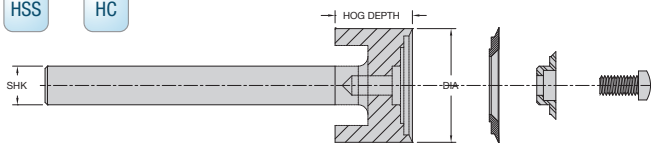

35% weight reduction has been designed into the larger diameter tools resulting in better performance on 3 or 5 axis machines. Part lifting and flagging have also been reduced due to the new tooth and flute design.

**Note:** Cutting blades sold separately.

Honeycomb Hogger					Cutting Blade Options							Spare Parts	
Part Number	Cutting DIA	Hogger Depth	SHK DIA	OAL	Blade Diameter	HSS	HSS w/Teeth	Solid Carbide	Solid Carbide w/Teeth	Diamond Plated	HSS Saw	Adapter Ring	Screw
30-703	.345 (8.76mm)	1	1/2	3	3/8 (9.52mm)	30-016	30-316	-	-	-	-	-	HRD51646
30-705	.470 (11.93mm)	1	1/2	3	1/2 (12.7mm)	30-017	30-317	-	-	-	-	-	HRD51646
30-707	.720 (18.28mm)	1	1/2	3	3/4 (19.05mm)	-	-	30-015	30-318	-	-	-	30-011-2
30-710	.970 (24.63mm)	1	1/2	3	1 (25.4mm)	-	-	30-012	30-313	30-113	30-213	-	30-011-2
30-715	1.470 (37.33mm)	1	1/2	3	1-1/2 (38.10mm)	-	-	30-014	30-314	30-114	30-214	30-020-3	30-020-4
30-720	1.742 (44.24mm)	1	1/2	3	1.772 (45mm)	-	-	30-026	30-326	30-126	30-226	30-020-3	30-020-4
30-725	1.970 (50.03mm)	1	5/8	3	2 (50.8mm)	-	-	30-022	30-322	30-122	30-222	30-020-3	30-020-4
30-730	2.450 (62.23mm)	1	5/8	3	2.480 (63mm)	-	-	30-036	30-336	30-136	30-236	30-030-3	30-030-4
30-735	2.970 (75.43mm)	1	3/4	3	3 (76.20mm)	-	-	30-032	30-332	30-132	30-232	30-030-3	30-030-4
30-740	3.970 (100.83mm)	1	3/4	3	4 (101.6mm)	-	-	30-042	30-342	30-142	30-242	30-040-3	30-040-4

1 = 50mm Diameter Honeycomb Blade

See page 27 for Images of Cutting Blades

## 31-000 Series Cutter

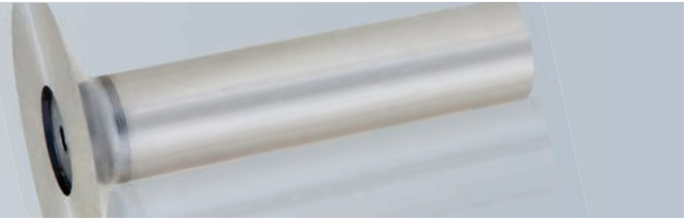

HSS

HC

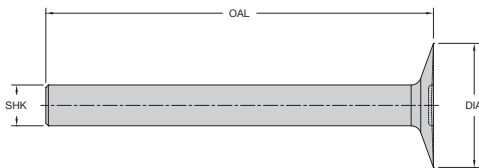

Designed primarily for use on aluminum core, offering the versatility of smaller sizes for use on hand-held machines in field or maintenance type repairs. This cutter offers the strength of an integral shank and blade that has an edge sharpness unattainable with any other material. This sharpness and the relieved bottom yield part surfaces that require a minimum of preparation before bonding operation.

31-000 Series High Speed Steel Cutter Product Offering

Part Number	Cutting DIA (in)	SHK DIA (in)	OAL (in)
31-010	1/2	1/4	2-1/16
31-015	3/4	1/4	2-3/32
31-020	1	1/4	2-1/8
31-025	1-1/2	1/2	2-1/4
31-030	2	1/2	2-3/4
31-040	3	1/2	2-15/16

Core Type	Rating
Aluminum, Lo Density (Less than 5#/cuft)	1
Aluminum, Hi Density (More than 5#/cuft)	2
Paper	2
Paper, Reinforced	N
Fiberglass	N
Phenolic	N
Polycarbonate	N
Aramid	N

1 = Excellent, 2 = Good, N = Not Recommended

## 31-100 Series Cutter With Teeth

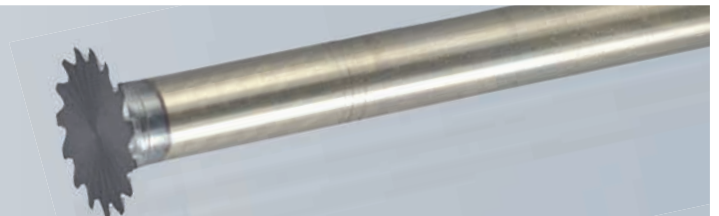

HSS

TiCN

HC

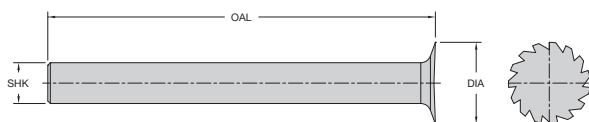

Small diameter honeycomb cutters were designed to offer the flexibility of cutting small slots or pockets in honeycomb core. The tools are versatile and can be used on CNC machines or hand held machines for field or maintenance type repairs.

31-100 Series High Speed Steel Honeycomb Cutter With Teeth Product Offering

Part Number	Cutting DIA (in)	SHK DIA (in)	OAL (in)
31-102TCN	3/8	1/4	3
31-104TCN	1/2	1/4	3
31-106TCN	5/8	1/4	3
31-108TCN	3/4	1/4	3

# 32-200 Series Three Piece Hogger

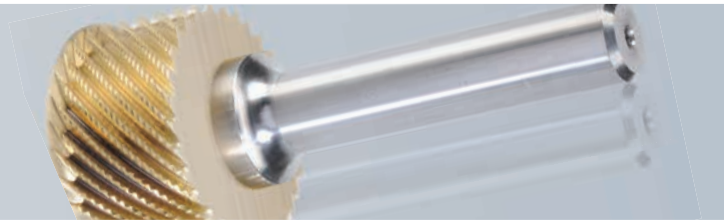

HSS ZRN HC

Designed with aggressive hogger geometry. Both the hogger and blade with teeth have a fine tooth grind pattern resulting in increased feed rates and improved part finish. All hogs and blades are coated with a ZRN coating for increase in tool life. All hogger assemblies require a shank, a hogger, and a blade. This design also allows the tool to be used without the hogger by replacing the hogger with a spacer.

**Note:** Hogs, Arbors and Cutting Blades Sold Separately.

See page 27 for Images of Cutting Blades

Honeycomb Hogger			Arbor			Cutting Blade Options			Spare Parts	
Part Number	Cutting DIA (in)	Hogger Depth	Part Number	Shank DIA	OAL	Blade Diameter	Solid Carbide	Solid Carbide w/Teeth	Spacer	Retaining Screw
32-210	0.94" (23.88mm)	1" (25.4mm)	32-221	3/8"	4"	1" (25.4mm)	32-412	32-512	32-221-3	32-221-4
32-225	1.94" (49.28mm)	1" (25.4mm)	32-231	1/2"	4"	2" (50.8mm)	32-422	32-522	32-231-3	32-231-4
			32-241	5/8"	4"					
32-235	2.94" (74.68mm)	1" (25.4mm)	32-231	1/2"	4"	3" (76.2mm)	32-432	32-532	32-231-3	32-231-4
			32-241	5/8"	4"					
32-220	1.72" (43.69mm)	1" (25.4mm)	32-231	1/2"	4"	1.77" (45mm)	32-426	32-526	32-231-3	32-231-4
			32-241	5/8"	4"					
32-230	2.42" (61.47mm)	1" (25.4mm)	32-231	1/2"	4"	2.48" (63mm)	32-436	32-536	32-231-3	32-231-4
			32-241	5/8"	4"					

32-201 - Wrench for 32-200 Tools (for Shank Diameters 1/2" & 5/8")

32-202 - Wrench for 32-200 Tools (for Shank Diameters 3/8")

32-205 - Keystock Replacement

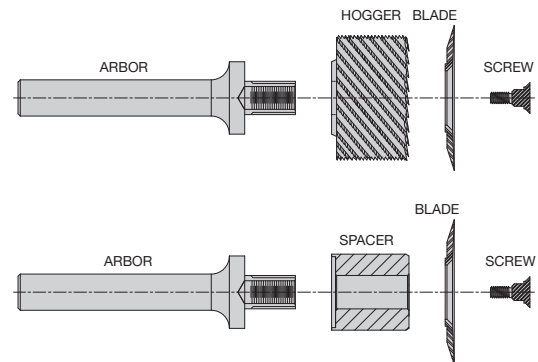

# 34-000 Series Aircraft Panel Tools



PCD   DIA  
grit   HSS   HC

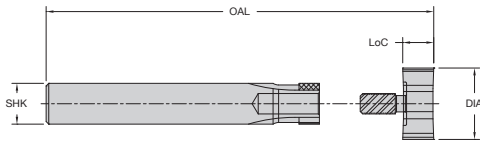

This modular tool is designed to produce slots in composite panels so potting compound can be applied to strengthen the edge. This tool consists of a PCD arbor which accepts a diamond grit or HSS under cutting tool to be screwed into it.

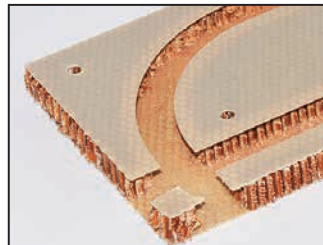

34-000 Series Solid Aircraft Panel Tools Product Offering				
Part Number	Cutting DIA (in)	LoC (in)	SHK DIA (in)	
34-008	1/2	-	1/2	Arbor (non-cutting)
34-010	1/2	1/4	1/2	PCD Arbor
34-022	7/8	0.130	n/a	Diamond Grit Cutter
34-024	7/8	0.250	n/a	Diamond Grit Cutter
34-026	7/8	0.380	n/a	Diamond Grit Cutter
34-028	7/8	0.500	n/a	Diamond Grit Cutter
34-030	7/8	0.630	n/a	Diamond Grit Cutter
34-042	7/8	0.130	n/a	HSS Cutter
34-044	7/8	0.250	n/a	HSS Cutter
34-046	7/8	0.380	n/a	HSS Cutter
34-048	7/8	0.500	n/a	HSS Cutter
34-050	7/8	0.630	n/a	HSS Cutter

# 34-100 Series Potted Fastener Tools

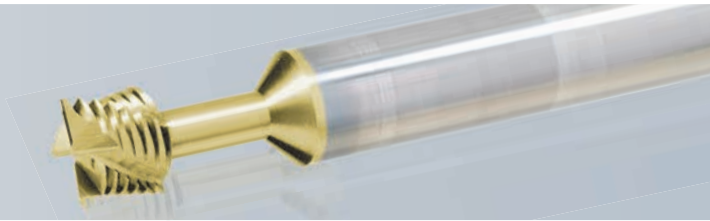

SC ZRN HC

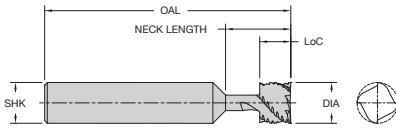

The tool was designed to eliminate the inconsistencies in producing the holes in aircraft interior panels to mount potted, glued in, fasteners. This tool for composite panels will plunge and shred the HCC. In aluminum panels an entry hole is required but the HCC shred is clean and effective. Coated for increased tool life.



Hole for Fastener Produced with 34-100 Series



Potted Fastener

## 34-100 Series Potted Fastener Tools Product Offering

Part Number	Cutting DIA (in)	LoC (in)	SHK DIA (in)	Neck DIA	Neck Length	OAL (in)
34-107	0.453	0.13	1/2	0.18	0.80	3
34-109	0.453	0.25	1/2	0.18	0.80	3
34-111	0.453	0.38	1/2	0.18	0.80	3
34-113	0.453	0.50	1/2	0.18	0.80	3
34-115	0.500	0.13	1/2	0.19	0.80	3
34-117	0.500	0.25	1/2	0.19	0.80	3
34-119	0.500	0.38	1/2	0.19	0.80	3
34-121	0.500	0.50	1/2	0.19	0.80	3
34-123	0.563	0.13	1/2	0.22	0.80	3
34-125	0.563	0.25	1/2	0.22	0.80	3
34-127	0.563	0.38	1/2	0.22	0.80	3
34-129	0.563	0.50	1/2	0.22	0.80	3
34-131	0.630	0.13	5/8	0.25	0.80	3
34-133	0.630	0.25	5/8	0.25	0.80	3
34-135	0.630	0.38	5/8	0.25	0.80	3
34-137	0.630	0.50	5/8	0.25	0.80	3

## 34-100 Series Potted Fastener Tools Product Offering - Metric

Part Number	Cutting DIA (mm)	LoC (mm)	SHK DIA (mm)	Neck DIA (mm)	Neck Length (mm)	OAL (mm)
34-106	11.51	3.30	12	4.57	20.32	76
34-108	11.51	6.35	12	4.57	20.32	76
34-110	11.51	9.65	12	4.57	20.32	76
34-112	11.51	12.70	12	4.57	20.32	76
34-114	12.70	3.30	12	4.83	20.32	76
34-116	12.70	6.35	12	4.83	20.32	76
34-118	12.70	9.65	12	4.83	20.32	76
34-120	12.70	12.70	12	4.83	20.32	76
34-122	14.29	3.30	12	5.59	20.32	76
34-124	14.29	6.35	12	5.59	20.32	76
34-126	14.29	9.65	12	5.59	20.32	76
34-128	14.29	12.70	12	5.59	20.32	76
34-130	16	3.30	16	6.35	20.32	76
34-132	16	6.35	16	6.35	20.32	76
34-134	16	9.65	16	6.35	20.32	76
34-136	16	12.70	16	6.35	20.32	76

## 34-100 Series Potted Fastener Tools Product Offering Technical Data

RPM	Plunge Feed Rate	Feed Rate
10,000	40 IPM	80 IPM

Note: Must PRE-DRILL for Aluminum



## 40-000 Series Upcut Spiral



HSS SW HW A

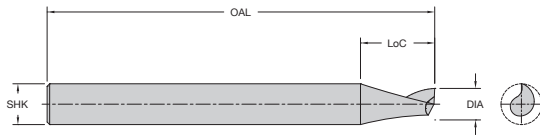

Designed for routing applications where speed and chip removal are primary considerations. They are also recommended when grooving, slotting or blind routing.

40-000 Series Single Flute - High Speed Steel **Upcut** Spiral Product Offering

Part Number	Cutting DIA (in)	LoC (in)	SHK DIA (in)	OAL (in)	Flutes
40-001	1/8	3/8	1/4	2-5/8	1
40-003	3/16	5/8	1/4	2-7/8	1
40-005	1/4	5/8	1/4	2-3/4	1
40-009	1/4	3/4	1/2	3-1/4	1
40-021	5/16	3/4	1/2	3-1/4	1
40-023	5/16	1	1/2	3-1/2	1
40-025	21/64	3/4	1/2	3-1/4	1
40-033	3/8	1	1/2	3-1/2	1

## 40-000 Series Downcut Spiral



HSS SW HW A

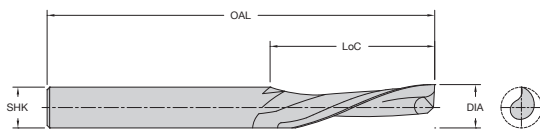

Designed for through cut routing operations where speed is the primary concern and fixturing is such that both chips and material are better off forced down.

40-000 Series Single Flute - High Speed Steel **Downcut** Spiral Product Offering

Part Number	Cutting DIA (in)	LoC (in)	SHK DIA (in)	OAL (in)	Flutes
40-008	1/4	3/4	1/4	2-3/4	1
40-012	1/4	1	1/4	3	1

# 40-100 Series Upcut Spiral

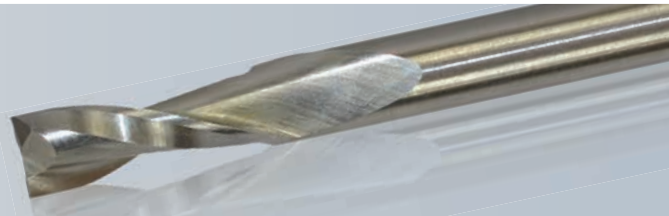

Provides a smoother finish when grooving, slotting or blind routing than do single flute tools. Recommended when fixturing requires upward chip removal.

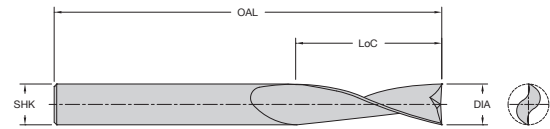

40-100 Series Two Flute - High Speed Steel <b>Upcut</b> Spiral Product Offering					
Part Number	Cutting DIA (in)	LoC (in)	SHK DIA (in)	OAL (in)	Flutes
40-101	1/8	3/8	1/4	2-5/8	2
40-103	3/16	5/8	1/4	2-7/8	2
40-153	7/32	7/8	1/4	3	2
40-105	1/4	5/8	1/4	2-3/4	2
40-107	1/4	3/4	1/4	2-3/4	2
40-109	1/4	3/4	1/2	3-1/4	2
40-111*	1/4	1	1/4	3	2
40-121	5/16	3/4	1/2	3-1/4	2

\* These tools are designed and toleranced for air routers with guide bushings.

40-100 Series Two Flute - High Speed Steel <b>Upcut</b> Spiral Product Offering					
Part Number	Cutting DIA (in)	LoC (in)	SHK DIA (in)	OAL (in)	Flutes
40-117	5/16	3/4	3/8	3	2
40-115	5/16	1	5/16	3	2
40-123	5/16	1	1/2	3-1/2	2
40-131*	3/8	1	3/8	3	2
40-133	3/8	1	1/2	3-1/2	2
40-135	3/8	1-1/4	1/2	3-3/4	2
40-137	1/2	1-1/4	1/2	3-1/4	2
40-139	1/2	1-1/2	1/2	3-1/2	2
40-141	3/4	1-1/4	1/2	3-1/4	2

# 40-100 Series Downcut Spiral

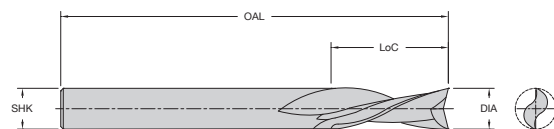

Provides a smoother finish than single flute in trimming and sizing. Recommended when chip flow should be directed down to protect the finish on the top of the material being cut.

\* These tools are designed and toleranced for air routers with guide bushings.

40-100 Series Two Flute - High Speed Steel <b>Downcut</b> Spiral Product Offering					
Part Number	Cutting DIA (in)	LoC (in)	SHK DIA (in)	OAL (in)	Flutes
40-102	1/8	5/16	1/4	2-5/8	2
40-104	3/16	5/8	1/4	2-7/8	2
40-106	1/4	5/8	1/4	2-3/4	2
40-108	1/4	3/4	1/4	2-3/4	2
40-110	1/4	3/4	1/2	3-1/4	2
40-112*	1/4	1	1/4	3	2
40-158*	1/4	1	1/4	3-1/4	2
40-122	5/16	3/4	1/2	3-1/4	2
40-116	5/16	1	5/16	3	2
40-124	5/16	1	1/2	3-1/2	2
40-134	3/8	1	1/2	3-1/2	2
40-138	1/2	1-1/4	1/2	3-1/4	2
40-140	1/2	1-1/2	1/2	3-1/2	2
40-142	3/4	1-1/4	1/2	3-1/4	2

## 40-550 Series Upcut Spiral

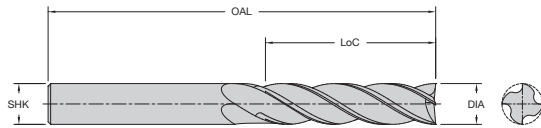
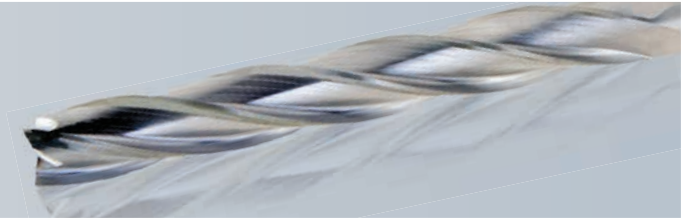

Designed to cut thick foam with upward chipflow.

40-550 Series Four Flute - High Speed Steel **Upcut** Spiral For Foam Product Offering

Part Number	Cutting DIA (in)	LoC (in)	SHK DIA (in)	OAL (in)	Flutes
40-562	1/2	3-5/8	1/2	6	4
40-564	1/2	4-1/8	1/2	6-1/2	4

HELIX ANGLE  $\approx 25^\circ$

## 48-000 Series Straight

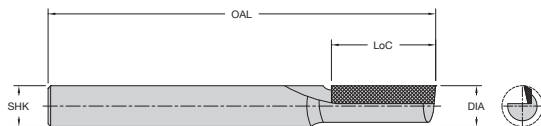

Designed for general usage where faster feed rates, free cutting action and long tool life are essential.

48-000 Series Single Flute - Carbide Tipped **Straight** Product Offering

Part Number	Cutting DIA (in)	LoC (in)	SHK DIA (in)	OAL (in)	Flutes
48-005	1/4	7/8	1/4	2-3/8	1
48-007	1/4	1	1/4	2-3/8	1
48-079*	1/4	1	1/4	3-1/4	1
48-056	3/8	1-1/4	1/2	2-3/4	1
48-069	1/2	1-1/2	1/2	3	1

\* These tools are designed and tolerated for Air Routers with guide bushings.

# 48-000 Series Straight

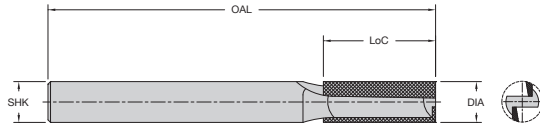

Designed for general usage where superior balance and vibration free cutting provides a smoother finish along with long tool life.

48-000 Series Two Flute - Carbide Tipped <b>Straight</b> Product Offering					
Part Number	Cutting DIA (in)	LoC (in)	SHK DIA (in)	OAL (in)	Flutes
48-008+	1/8	5/16	1/4	2	2
48-004	1/4	5/8	1/4	2-1/8	2
48-006	1/4	7/8	1/4	2-3/8	2
48-018	1/4	7/8	1/2	2-1/2	2
48-106	1/4	1	1/4	2-3/8	2
48-179*	1/4	1	1/4	3-1/4	2
48-010	5/16	1	1/4	2-1/2	2
48-012	3/8	3/4	1/4	2-1/4	2
48-036*	3/8	1	3/8	2-1/2	2
48-057	3/8	1	1/2	2-1/2	2
48-058*	3/8	1-1/4	3/8	3	2
48-158	3/8	1-1/4	1/2	2-3/4	2
48-014	1/2	3/4	1/4	2-1/8	2
48-072	1/2	1	1/2	2-1/2	2
48-076	1/2	1-1/4	1/2	2-3/4	2
48-080	1/2	1-1/2	1/2	3	2
48-081	1/2	2	1/2	4	2
48-183	1/2	2-1/2	1/2	4-1/2	2
48-015	5/8	1	1/4	2-1/4	2
48-086	5/8	1-1/4	1/2	2-3/4	2
48-016	3/4	1	1/4	2-1/4	2
48-088	3/4	1-1/4	1/2	3	2
48-215	3/4	2	3/4	4	2
48-096	7/8	1-1/4	1/2	2-3/4	2
48-100	1	1-1/4	1/2	2-3/4	2

+ Solid Carbide

\* These tools are designed and toleranced for Air Routers with guide bushings.

## 49-000 Series Downcut

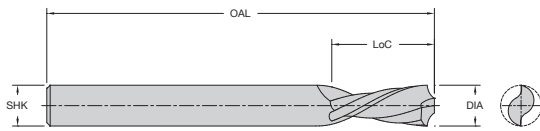

These double flute downcuts with a drill type point were developed initially as "Aircraft Throwaway" tools. They have many uses in trimming and routing primarily with hand held routers.

49-000 Series Two Flute - High Speed Steel **Downcut** Product Offering

Part Number	Cutting DIA (in)	LoC (in)	SHK DIA (in)	OAL (in)	Flutes
49-005	1/4	9/16	1/4	2-1/2	2
49-001	1/4	9/16	1/4	2-3/4	2
49-007	1/4	9/16	1/4	3-1/4	2
49-003	3/8	3/4	3/8	2-1/2	2

These tools are designed and tolerated for Air Routers with guide brushings. + .000 - .006  
HELIX ANGLE  $\approx 24^\circ$

## 52-000 Series Upcut Spiral

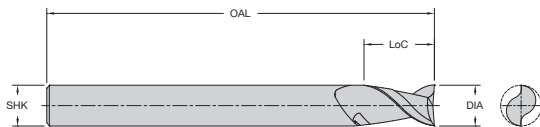
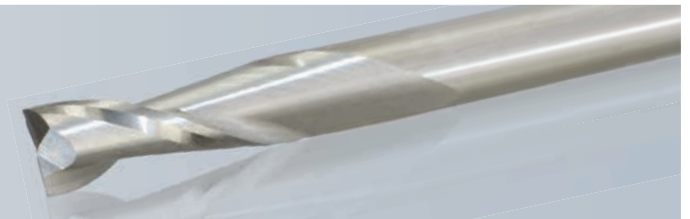

Designed as a general purpose spiral with several times the life of their high speed steel counterparts. They are used when upward chip flow is preferred.

52-000 Series Two Flute - Solid Carbide **Upcut Spiral** Product Offering

Part Number	Cutting DIA (in)	LoC (in)	SHK DIA (in)	OAL (in)	Flutes
52-040	1/8	1/2	1/4	2	2
52-050	5/32	9/16	1/4	2	2
52-060	3/16	5/8	1/4	2	2
52-080	1/4	3/4	1/4	2-1/2	2
52-100	5/16	13/16	3/8	2-1/2	2
52-120	3/8	7/8	3/8	2-1/2	2
52-160	1/2	1	1/2	3	2

HELIX ANGLE  $\approx 30^\circ$

# 52-200 Series Upcut Spiral Wood Rout

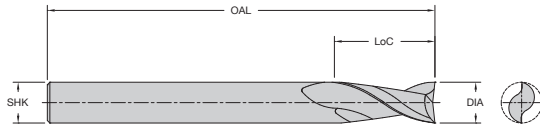
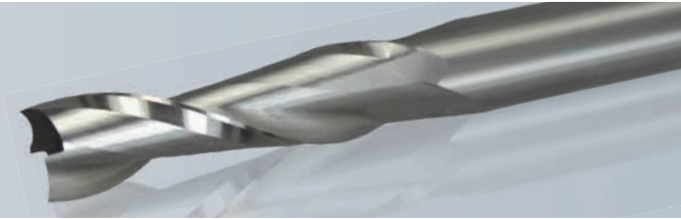

Designed for routing where upward chip removal, tool rigidity, long life and high quality finish is desired.

52-200 Series Two Flute - Solid Carbide <b>Upcut</b> Spiral Wood Rout Product Offering					
Part Number	Cutting DIA (in)	LoC (in)	SHK DIA (in)	OAL (in)	Flutes
52-244	1/8	1/2	1/8	2	2
52-240	1/8	1/2	1/4	2	2
52-250	5/32	5/8	1/4	2	2
52-260	3/16	3/4	1/4	2	2
52-261	3/16	3/4	1/4	2-1/2	2
52-280	1/4	7/8	1/4	2-1/2	2
52-285	1/4	1	1/4	2-1/2	2
52-287	1/4	1-1/8	1/4	3	2
52-300	5/16	1-1/8	5/16	3	2
52-310	5/16	1-1/8	1/2	3	2
52-310L	5/16	1-1/8	1/2	3	2
52-318*	3/8	1	3/8	3	2
52-320	3/8	1-1/8	3/8	3	2
52-325	3/8	1-1/4	3/8	3	2
52-330	3/8	1-1/4	1/2	3	2
52-340	7/16	1	1/2	3	2
52-360	1/2	1-1/8	1/2	3	2
52-362	1/2	1-1/4	1/2	3-1/2	2
52-365	1/2	1-5/8	1/2	3-1/2	2
52-365L	1/2	1-5/8	1/2	3-1/2	2
52-367	1/2	2-1/8	1/2	4	2
52-385	5/8	2-1/8	5/8	4	2
52-395	3/4	2-1/8	3/4	4	2

HELIX ANGLE = 30°

\*Special Point (Improved Bottom Finish)

L = Left Hand Rotation

## 52-200B/BL Series Upcut Spiral Ball Nose

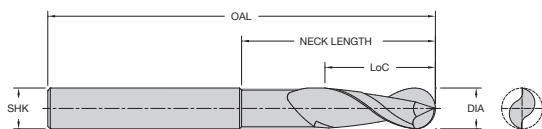
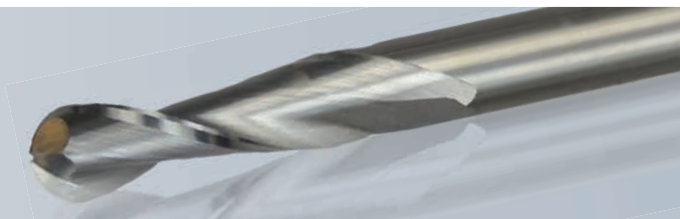

Designed for carving and modeling operations. Their improved tip geometry gives a superior cut compared to most ballnose endmills.

52-200B Series Two Flute - Solid Carbide **Upcut** Spiral Ball Nose Product Offering - Metric

Part Number	Cutting DIA (mm)	LoC (mm)	SHK DIA (mm)	OAL (mm)	Flutes
52-240BM	3	12	6	50	2
52-280BM	6	22	6	64	2
52-320BM	10	29	10	76	2
52-360BM	12	29	12	76	2

52-200B Series Two Flute - Solid Carbide **Upcut** Spiral Ball Nose Product Offering

Part Number	Cutting DIA (in)	LoC (in)	SHK DIA (in)	OAL (in)	Flutes
52-235B	1/16	1/4	1/8	2	2
52-244B	1/8	1/2	1/8	2	2
52-240B	1/8	1/2	1/4	2	2
52-260B	3/16	3/4	1/4	2	2
52-280B	1/4	7/8	1/4	2-1/2	2
52-320B	3/8	1-1/8	3/8	3	2
52-360B	1/2	1-1/8	1/2	3	2
52-386B	5/8	2-1/4	5/8	4	2
52-397B	3/4	2-1/2	3/4	5	2

52-200BL Series Two Flute - Solid Carbide **Upcut** Spiral Ball Nose - Extended Length Product Offering

Part Number	Cutting DIA (in)	LoC (in)	ERL (in)	SHK DIA (in)	OAL (in)	Flutes
52-235BL	1/16	1/4	-	1/8	3	2
52-244BL	1/8	1/2	1-5/8	1/8	3	2
52-240BL	1/8	1/2	1-5/8	1/4	3	2
52-260BL	3/16	3/4	1-5/8	1/4	3	2
52-280BL	1/4	1	2-5/8	1/4	4	2
52-320BL	3/8	1-1/4	2-5/8	3/8	4	2
52-360BL	1/2	1-1/2	3-5/8	1/2	5	2
52-386BL	5/8	2-1/2	3-5/8	5/8	5	2
52-397BL	3/4	3	4-5/8	3/4	6	2

## 52-400 Series Upcut Spiral Wood Rout

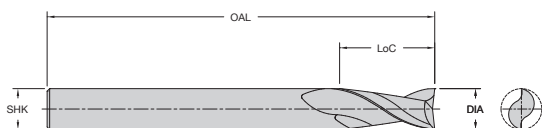
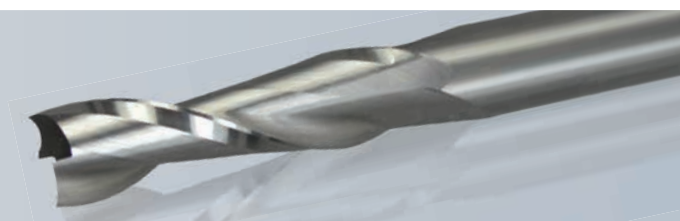

Designed for routing where upward chip removal, tool rigidity, long life and high quality finish is desired.

52-400 Series Two Flute - Solid Carbide **Upcut** Spiral Rout Product Offering - Metric

Part Number	Cutting DIA (mm)	LoC (mm)	SHK DIA (mm)	OAL (mm)	Flutes
52-410	4	16	6	64	2
52-411	5	20	6	64	2
52-412	6	25	6	64	2
52-414	8	25	8	64	2
52-416	10	35	10	76	2
52-418	12	35	12	76	2

HELIX ANGLE  $\approx$  30°

## 52-550 Series Upcut Foam Cutters

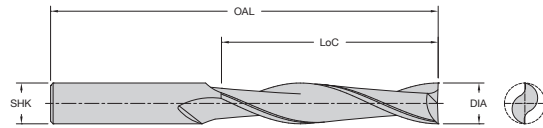
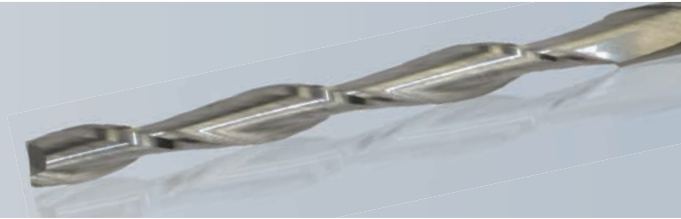

Foam cutters for thick material with upward chip flow.

52-550 Series Two Flute - Solid Carbide **Upcut** Foam Cutters  
Product Offering

Part Number	Cutting DIA (in)	LoC (in)	SHK DIA (in)	OAL (in)	Flutes
52-554	1/8	1-1/8	1/4	2-1/2	2
52-558	3/16	1-1/8	3/16	3	2
52-560	3/16	1-5/8	3/16	4	2
52-564	1/4	2-1/4	1/4	4	2
52-570	5/16	3-1/8	5/16	6	2
52-574	3/8	3-1/2	3/8	6	2

HELIX ANGLE  $\approx 25^\circ$

## 52-600 Series Upcut Spiral O Flute

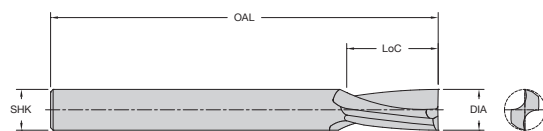
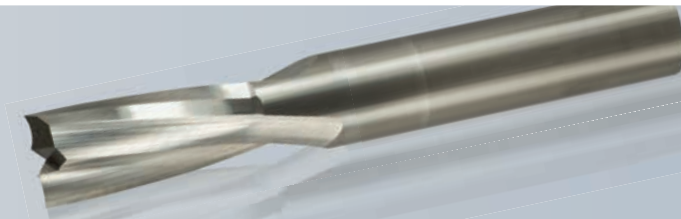

Low helix geometry designed to cut soft and hard plastic with a smooth finish and upward chip flow.

52-600 Series Two Flute - Solid Carbide **Upcut** Spiral O Flute  
Product Offering

Part Number	Cutting DIA (in)	LoC (in)	SHK DIA (in)	OAL (in)	Flutes
52-622	1/4	3/8	1/4	2-1/2	2
52-624	1/4	3/4	1/4	2-1/2	2
52-638	3/8	1	3/8	3	2
52-650	1/2	1-1/8	1/2	3-1/2	2
52-652	1/2	1-5/8	1/2	3-1/2	2
52-655	1/2	2-1/8	1/2	4-1/2	2
52-660	5/8	2-1/8	5/8	5	2
52-664	3/4	3-1/8	3/4	6	2

HELIX ANGLE  $\approx 11^\circ$



## 52-700 Series Upcut Spiral O Flute

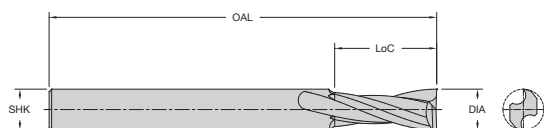

High helix geometry designed to cut soft plastic with a smooth finish and upward chip flow. Special point geometry for improved bottom finish.

52-700 Series Two Flute - Solid Carbide <b>Upcut</b> Foam Cutters Product Offering - Metric					
Part Number	Cutting DIA (mm)	LoC (mm)	SHK DIA (mm)	OAL (mm)	Flutes
52-742	12	35	12	100	2
52-744	12	45	12	100	2
52-746	12	55	12	100	2
52-752	16	45	16	120	2
52-754	16	55	16	120	2
52-764	20	65	20	125	2

52-700 Series Two Flute - Solid Carbide <b>Upcut</b> Spiral O Flute Product Offering					
Part Number	Cutting DIA (in)	LoC (in)	SHK DIA (in)	OAL (in)	Flutes
52-703	1/8	1/2	1/4	2	2
52-707	1/4	7/8	1/4	3	2
52-708	3/16	3/8	3/16	2-1/2	2
52-700	1/4	1-1/4	1/4	3	2
52-709	3/8	1	3/8	3	2
52-710	3/16	5/8	1/4	2-1/2	2
52-701	3/8	1-1/2	3/8	4	2
52-702	1/2	1-1/4	1/2	4	2
52-704	1/2	1-3/4	1/2	4	2
52-706	1/2	2-1/8	1/2	4	2
52-712	5/8	1-3/4	5/8	5	2
52-714	5/8	2-1/4	5/8	5	2
52-726	3/4	1-3/4	3/4	5	2
52-724	3/4	2-1/2	3/4	5	2
52-728	3/4	4	3/4	6-1/2	2
52-734	1	4	1	6-1/2	2

HELIX ANGLE  $\approx$  22°

## 52-900 Series Upcut Extreme Heavy Duty

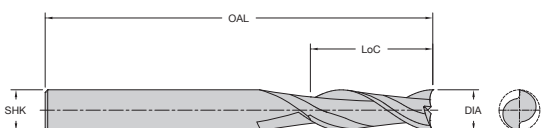
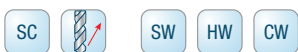

Developed for demanding applications where upward chip removal, tool rigidity and long life are essential to success.

52-900 Series Two Flute - Solid Carbide <b>Upcut</b> Extreme Heavy Duty Standard Product Offering					
Part Number	Cutting DIA (in)	LoC (in)	SHK DIA (in)	OAL (in)	Flutes
52-910	1/4	7/8	1/4	2-1/2	2
52-914	1/4	1-1/4	1/4	3	2
52-923	3/8	1-1/8	3/8	3	2
52-936	1/2	1-1/4	1/2	3	2

HELIX ANGLE  $\approx$  30°

# 54-200 Series Spiral Glass-Reinforced Plastic

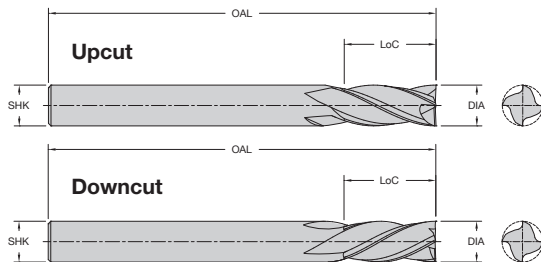
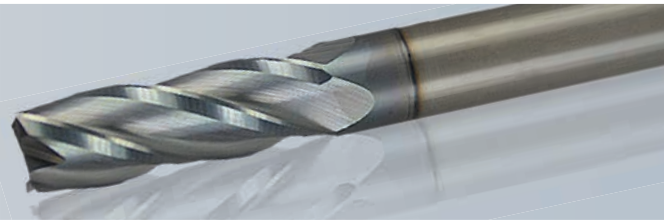

Three and four flute tools for machining glass-reinforced plastic. Geometry has been optimized to shear the glass fibers while creating a chip which removes heat from the cut to avoid melting of the material. Tools are coated to withstand the abrasive characteristics inherent to Glass Reinforced Plastic (GRP).

54-200 Series Solid Carbide Spiral for Glass-Reinforced Plastic (**Upcut**) Product Offering

Part Number	Cutting DIA (in)	LoC (in)	SHK DIA (in)	OAL (in)	Flutes
54-205	1/8	1/2	1/4	2-1/2	3
54-210	3/16	5/8	1/4	2-1/2	3
54-220	1/4	3/4	1/4	2-1/2	4
54-230	3/8	1-1/8	3/8	3	4
54-240	1/2	1-1/8	1/2	3-1/2	4

54-200 Series Solid Carbide Spiral for Glass-Reinforced Plastic (**Upcut**) Product Offering - Metric

Part Number	Cutting DIA (mm)	LoC (mm)	SHK DIA (mm)	OAL (mm)	Flutes
54-260	6	19	6	76	4
54-266	8	22	8	76	4
54-270	10	25	10	76	4
54-276	12	25	12	76	4

54-200 Series Solid Carbide Spiral for Glass-Reinforced Plastic (**Downcut**) Product Offering

Part Number	Cutting DIA (in)	LoC (in)	SHK DIA (in)	OAL (in)	Flutes
54-206	1/8	1/2	1/4	2-1/2	3
54-211	3/16	5/8	1/4	2-1/2	3
54-221	1/4	3/4	1/4	2-1/2	4
54-231	3/8	1-1/8	3/8	3	4
54-241	1/2	1-1/8	1/2	3-1/2	4

54-200 Series Solid Carbide Spiral for Glass-Reinforced Plastic (**Downcut**) Product Offering - Metric

Part Number	Cutting DIA (mm)	LoC (mm)	SHK DIA (mm)	OAL (mm)	Flutes
54-261	6	19	6	76	4
54-267	8	22	8	76	4
54-271	10	25	10	76	4
54-277	12	25	12	76	4

## 56-000 Series Straight

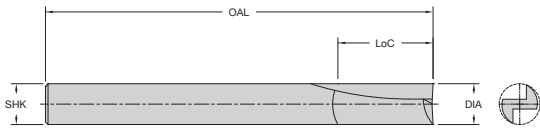
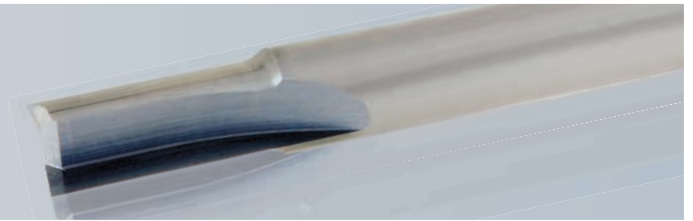

Designed to rout composite plastic.

56-000 Series Two Flute - Solid Carbide **Straight** Product Offering

Part Number	Cutting DIA (in)	LoC (in)	SHK DIA (in)	OAL (in)	Flutes
56-040	1/8	1/2	1/4	2	2
56-060	3/16	5/8	1/4	2	2
56-080	1/4	3/4	1/4	2-1/2	2
56-084*	1/4	3/4	1/4	3-1/4	2
56-100	5/16	13/16	3/8	2-1/2	2
56-160	1/2	1	1/2	3	2

\* These tools are designed and tolerated for air routers with guide bushings.

## 56-000P Series Straight

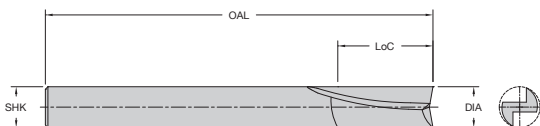
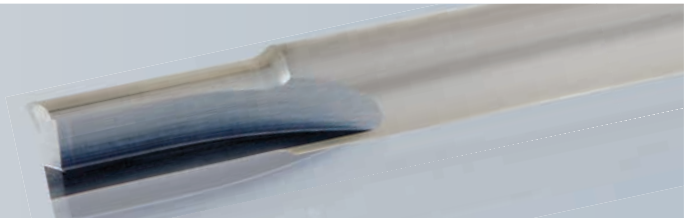

Designed specifically to rout harder, more rigid plastics.

56-000P Series Two Flute - Solid Carbide **Straight** Product Offering

Part Number	Cutting DIA (in)	LoC (in)	SHK DIA (in)	OAL (in)	Flutes
56-041	1/8	1/4	1/4	2	2
56-061	3/16	3/8	1/4	2	2
56-062	3/16	5/8	1/4	2	2
56-062L	3/16	5/8	1/4	2	2
56-063*	3/16	5/8	1/4	4	2
56-081	1/4	3/8	1/4	2-1/2	2
56-082	1/4	3/4	1/4	2-1/2	2
56-082L	1/4	3/4	1/4	2-1/2	2
56-086*	1/4	1-1/4	1/4	4	2
56-121	3/8	5/8	3/8	2-1/2	2
56-122	3/8	7/8	3/8	2-1/2	2
56-122L	3/8	7/8	3/8	2-1/2	2
56-124*	3/8	1-5/8	3/8	6	2
56-162	1/2	1	1/2	3	2
56-162L	1/2	1	1/2	3	2
56-164*	1/2	2-1/8	1/2	6	2

\* These tools are designed and tolerated for air routers with guide bushings.

L = Left Hand Rotation

## 56-200 Series Straight Wood Rout

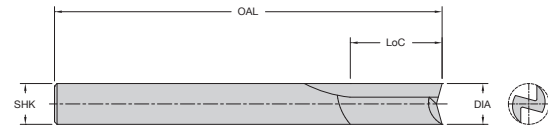
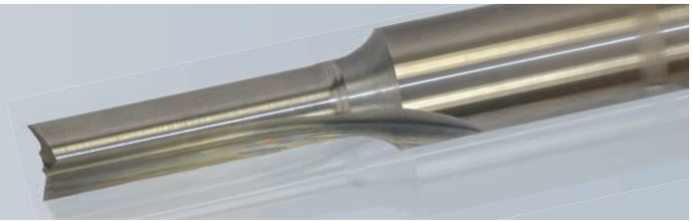

Provides a superior finish in a variety of wood materials and optimum cutter life.

56-200 Series Two Flute - Solid Carbide <b>Straight</b> Wood Rout Product Offering					
Part Number	Cutting DIA (in)	LoC (in)	SHK DIA (in)	OAL (in)	Flutes
56-240	1/8	1/2	1/4	2	2
56-250	5/32	5/8	1/4	2	2
56-260	3/16	3/4	1/4	2	2
56-270	7/32	3/4	1/4	2-1/2	2
56-280	1/4	7/8	1/4	2-1/2	2
56-285	1/4	1	1/4	2-1/2	2
56-287	1/4	1-1/8	1/4	3	2
56-300	5/16	1-1/8	5/16	3	2
56-310	5/16	1-1/8	1/2	3	2
56-320	3/8	1-1/8	3/8	3	2
56-330	3/8	1-1/4	1/2	3	2
56-360	1/2	1-1/8	1/2	3	2
56-365	1/2	1-5/8	1/2	3-1/2	2
56-390	3/4	1-5/8	3/4	4	2

## 56-430 Series Straight O Flute

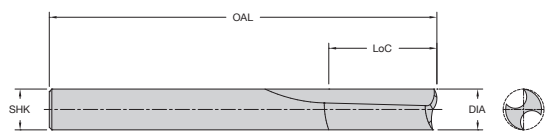
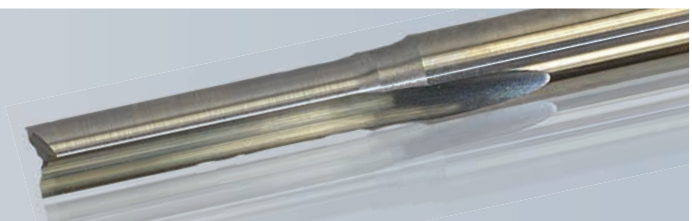

Designed with free cutting O flute geometry along with a double flute design for smooth finish.

56-430 Series Two Flute - Solid Carbide <b>Straight</b> O Flute Product Offering - Metric					
Part Number	Cutting DIA (mm)	LoC (mm)	SHK DIA (mm)	OAL (mm)	Flutes
56-430	4	16	6	64	2
56-431	5	20	6	64	2
56-432	6	25	6	64	2
56-434	8	25	8	76	2
56-436	10	35	10	88	2
56-438	12	35	12	88	2

## 56-450 Series Straight

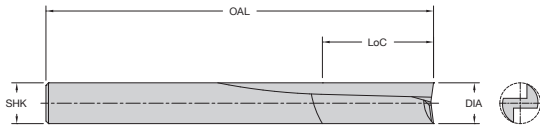
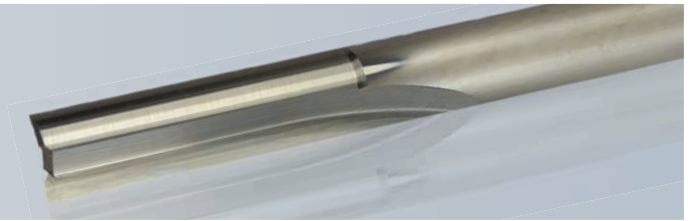

Designed specifically to rout harder, more rigid plastics

56-450 Series Two Flute - Solid Carbide **Straight** Product Offering - Metric

Part Number	Cutting DIA (mm)	LoC (mm)	SHK DIA (mm)	OAL (mm)	Flutes
56-450	4	16	6	64	2
56-451	5	20	6	64	2
56-452	6	25	6	64	2
56-454	8	25	8	76	2
56-456	10	35	10	88	2
56-458	12	35	12	88	2

## 56-600 Series O Flute Straight

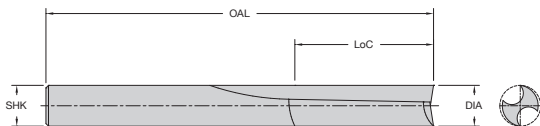
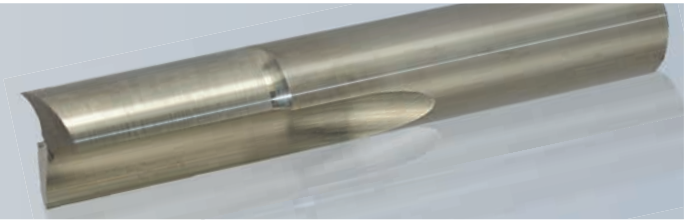

Designed with free cutting O flute geometry along with a double flute design for smooth finish.

56-600 Series Two Flute - Solid Carbide O Flute **Straight** Product Offering

Part Number	Cutting DIA (in)	LoC (in)	SHK DIA (in)	OAL (in)	Flutes
56-610	1/8	5/16	1/4	2	2
56-612	1/8	1/2	1/4	2	2
56-614	1/8	5/8	1/4	4	2
56-616	3/16	3/8	1/4	2	2
56-618	3/16	5/8	1/4	2	2
56-620	3/16	1	1/4	4	2
56-624	1/4	3/8	1/4	2-1/2	2
56-625	1/4	1	1/4	2-1/2	2
56-625L	1/4	1	1/4	2-1/2	2
56-626	1/4	1	1/4	3-1/4	2
56-628	1/4	1-1/4	1/4	4	2
56-638	3/8	7/8	3/8	2-1/2	2
56-639	3/8	1	3/8	4	2
56-650	1/2	1	1/2	3	2
56-652	1/2	1	1/2	4	2
56-654	1/2	1-3/4	1/2	4	2
56-655	1/2	2-1/8	1/2	6	2

L = Left Hand Rotation

# 57-000 Series Downcut Spiral

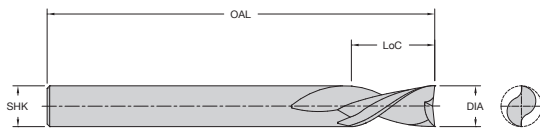
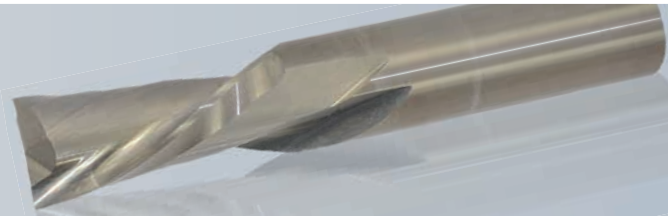

Designed as a general purpose spiral with several times the life of their high speed counterparts. They are used when a downward chipflow action is preferred.

57-000 Series Two Flute - Solid Carbide <b>Downcut</b> Spiral Product Offering					
Part Number	Cutting DIA (in)	LoC (in)	SHK DIA (in)	OAL (in)	Flutes
57-040	1/8	1/2	1/4	2	2
57-060	3/16	5/8	1/4	2	2
57-080	1/4	3/4	1/4	2-1/2	2
57-120	3/8	7/8	3/8	2-1/2	2
57-160	1/2	1	1/2	3	2

HELIX ANGLE  $\approx 30^\circ$

# 57-200 Series Downcut

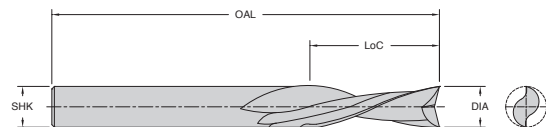
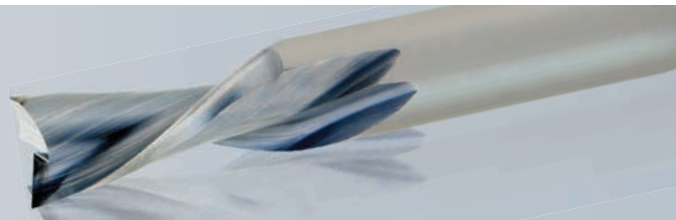

Designed for routing where downward chip removal, tool rigidity, long life, and high quality finish is desired.

57-200 Series Two Flute - Solid Carbide <b>Downcut</b> Spiral Wood Rout					
Part Number	Cutting DIA (in)	LoC (in)	SHK DIA (in)	OAL (in)	Flutes
57-244	1/8	1/2	1/8	2	2
57-240	1/8	1/2	1/4	2	2
57-240L	1/8	1/2	1/4	2	2
57-251	5/32	1/2	1/4	2-1/2	2
57-250	5/32	5/8	1/4	2	2
57-260	3/16	3/4	1/4	2	2
57-261	3/16	3/4	1/4	2-1/2	2
57-280	1/4	7/8	1/4	2-1/2	2
57-285	1/4	1	1/4	2-1/2	2
57-285L	1/4	1	1/4	2-1/2	2
57-287	1/4	1-1/8	1/4	3	2
57-290	9/32	1	5/16	2-1/2	2
57-300	5/16	1-1/8	5/16	3	2
57-310	5/16	1-1/8	1/2	3	2
57-310L	5/16	1-1/8	1/2	3	2
57-318*	3/8	1	3/8	3	2

57-200 Series Two Flute - Solid Carbide <b>Downcut</b> Spiral Wood Rout					
Part Number	Cutting DIA (in)	LoC (in)	SHK DIA (in)	OAL (in)	Flutes
57-320	3/8	1-1/8	3/8	3	2
57-325	3/8	1-1/4	3/8	3	2
57-330	3/8	1-1/4	1/2	3	2
57-340	7/16	1	1/2	3	2
57-360	1/2	1-1/8	1/2	3	2
57-362	1/2	1-1/4	1/2	3-1/2	2
57-365	1/2	1-5/8	1/2	3-1/2	2
57-365L	1/2	1-5/8	1/2	3-1/2	2
57-367	1/2	2-1/8	1/2	4	2
57-370	17/32	1-1/8	1/2	3	2
57-380	5/8	1-5/8	5/8	3-1/2	2
57-385	5/8	2-1/8	5/8	4	2
57-390	3/4	1-5/8	3/4	4	2
57-395	3/4	2-1/8	3/4	5	2
57-395L	3/4	2-1/8	3/4	5	2

HELIX ANGLE  $\approx 30^\circ$

\* Special Point (Improved Bottom Finish)

L = Left Hand Rotation

## 57-200MD Series Marathon Downcut

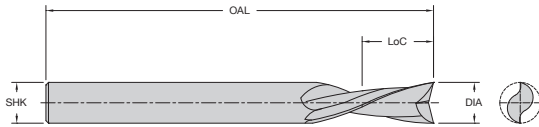
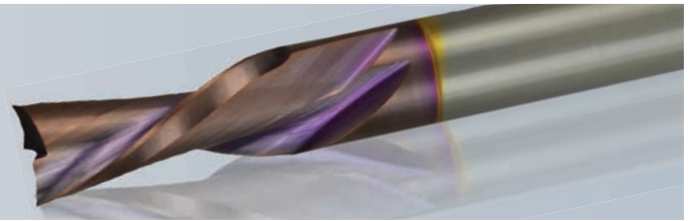

The longest running downcut in the industry due to advancements in geometry and the addition of a unique Onsrud coating.

57-200MD Series Two Flute - Marathon Wood Rout **Downcut**  
Product Offering

Part Number	Cutting DIA (in)	LoC (in)	SHK DIA (in)	OAL (in)	Flutes
57-278MD	1/4	3/8	1/4	2-1/2	2
57-279MD	1/4	5/8	1/4	2-1/2	2
57-317MD	3/8	7/8	3/8	3	2
57-359MD	1/2	7/8	1/2	3	2

## 57-400 Series Downcut Spiral Wood Rout

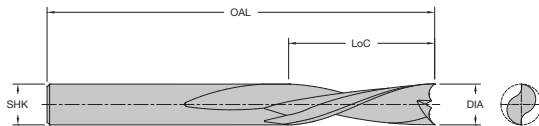
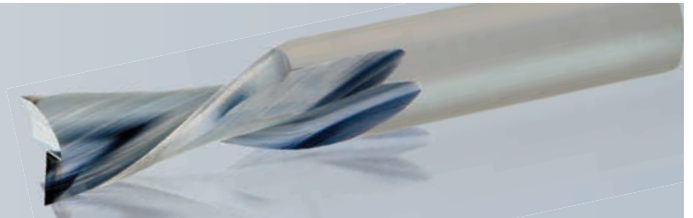

Designed for routing where downward chip removal, tool rigidity, long life, and high quality finish is desired.

57-400 Series Two Flute - Solid Carbide **Downcut** Spiral Wood Rout  
Product Offering - Metric

Part Number	Cutting DIA (mm)	LoC (mm)	SHK DIA (mm)	OAL (mm)	Flutes
57-410	4	16	6	64	2
57-411	5	20	6	64	2
57-412	6	25	6	64	2
57-414	8	25	8	64	2
57-416	10	35	10	76	2

HELIX ANGLE  $\approx 30^\circ$

## 57-600 Series Downcut Spiral O Flute

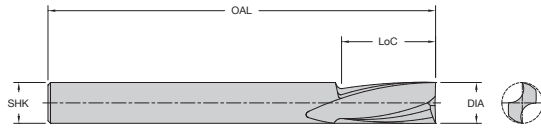

Designed to cut plastic with a smooth finish and downward chip flow.

57-600 Series Two Flute - Solid Carbide **Downcut** Spiral O Flute Product Offering

Part Number	Cutting DIA (in)	LoC (in)	SHK DIA (in)	OAL (in)	Flutes
57-623	1/4	3/8	1/4	2-1/2	2
57-625	1/4	3/4	1/4	2-1/2	2
57-637	3/8	1	3/8	3	2
57-651	1/2	1-1/8	1/2	3-1/2	2

HELIX ANGLE  $\approx$  10-11°

57-600 Series Two Flute - Solid Carbide **Downcut** Spiral O Flute Product Offering - Metric

Part Number	Cutting DIA (mm)	LoC (mm)	SHK DIA (mm)	OAL (mm)	Flutes
57-627	6	25	6	64	2
57-639	8	25	8	76	2

## 57-900 Series Downcut Extreme Heavy Duty

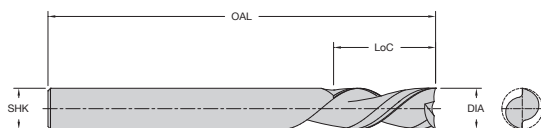
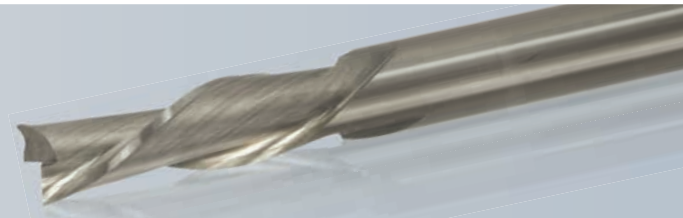

Designed for routing where extreme loads are placed upon the cutting tools and when extra part hold down is required.

57-900 Series Two Flute - Solid Carbide **Downcut** Extreme Heavy Duty Standard Product Offering

Part Number	Cutting DIA (in)	LoC (in)	SHK DIA (in)	OAL (in)	Flutes
57-910	1/4	7/8	1/4	2-1/2	2
57-921	3/8	7/8	3/8	3	2
57-923	3/8	1-1/8	3/8	3	2
57-924	3/8	1-1/4	3/8	3	2
57-936	1/2	1-1/4	1/2	3	2
57-940	1/2	1-5/8	1/2	3-1/2	2

HELIX ANGLE  $\approx$  30°



## 60-000 Series High Helix Hogger



Designed with unique scalloped cutting edge design for extremely fast machining and roughing. Faster chip removal with upcuts. Better hold down with downcuts.

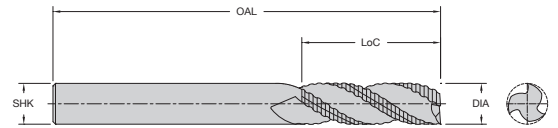

60-000 Series Three Flute - Solid Carbide High Helix Hogger (Upcut) Product Offering					
Part Number	Cutting DIA (in)	LoC (in)	SHK DIA (in)	OAL (in)	Flutes
60-001	3/8	1-1/8	3/8	3-1/2	3
60-005	1/2	1-1/8	1/2	3-1/2	3
60-007	1/2	1-5/8	1/2	4	3
60-011	5/8	2-1/8	5/8	5	3
60-017	3/4	1-5/8	3/4	4	3
60-019	3/4	2-1/8	3/4	5	3

HELIX ANGLE  $\approx 30^\circ$

60-000 Series Three Flute - Solid Carbide High Helix Hogger (Downcut) Product Offering					
Part Number	Cutting DIA (in)	LoC (in)	SHK DIA (in)	OAL (in)	Flutes
60-002	3/8	1-1/8	3/8	3-1/2	3
60-006	1/2	1-1/8	1/2	3-1/2	3
60-008	1/2	1-5/8	1/2	4	3
60-012	5/8	2-1/8	5/8	5	3
60-018	3/4	1-5/8	3/4	4	3
60-020	3/4	2-1/8	3/4	5	3

## 60-000 Series Low Helix Hogger

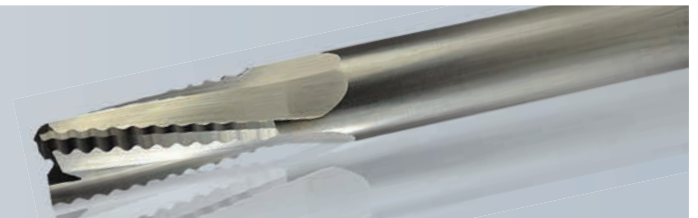

Designed with unique scalloped cutting geometry which provides extremely fast roughing, lower horsepower requirements, longer tool life, and reduced chipping in solid wood materials.

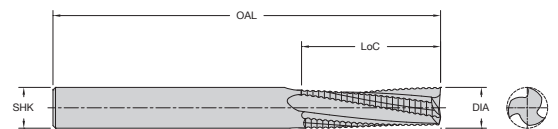

60-000 Series Three Flute - Solid Carbide Low Helix Hogger (Upcut) Product Offering					
Part Number	Cutting DIA (in)	LoC (in)	SHK DIA (in)	OAL (in)	Flutes
60-037	3/8	1-1/8	3/8	3-1/2	3
60-053	1/2	1-1/8	1/2	3-1/2	3
60-051	1/2	1-5/8	1/2	4	3
60-061	5/8	2-1/8	5/8	5	3
60-073	3/4	1-5/8	3/4	4	3
60-071	3/4	2-1/8	3/4	5	3

HELIX ANGLE  $\approx 10^\circ$

60-000 Series Three Flute - Solid Carbide Low Helix Hogger (Downcut) Product Offering					
Part Number	Cutting DIA (in)	LoC (in)	SHK DIA (in)	OAL (in)	Flutes
60-038	3/8	1-1/8	3/8	3-1/2	3
60-054	1/2	1-1/8	1/2	3-1/2	3
60-052	1/2	1-5/8	1/2	4	3
60-074	3/4	1-5/8	3/4	5	3
60-072	3/4	2-1/8	3/4	5	3

# 60-090 Series Upcut Lock Mortise

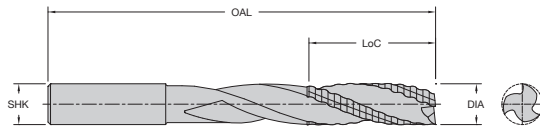
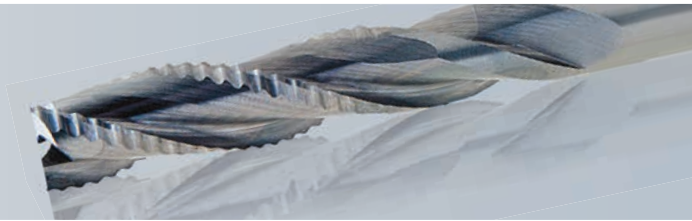

The scalloped upcut cutting edge design and extra spinback provide fast material removal in deep cuts for horizontal and vertical lock mortise routing.

60-090 Series Three Flute - Solid Carbide <b>Upcut</b> Lock Mortise Product Offering						
Part Number	Cutting DIA (in)	LoC (in)	Max DOC (in)	SHK DIA (in)	OAL (in)	Flutes
60-090	5/8	2	4-1/2	5/8	6-1/2	3

HELIX ANGLE  $\approx 30^\circ$

60-090 Series Three Flute - Solid Carbide <b>Upcut</b> Lock Mortise Product Offering - Metric						
Part Number	Cutting DIA (mm)	LoC (mm)	Max DOC (mm)	SHK DIA (mm)	OAL (mm)	Flutes
60-091	16	50	114	16	170	3

HELIX ANGLE  $\approx 30^\circ$

# 60-100PLR Series Polaris Compression Spiral

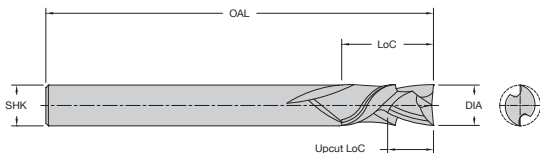
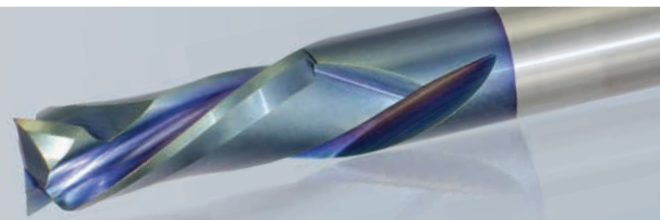

The Polaris Compression Series is the latest advancement in compression tool technology by LMT Onsrud, the innovator of compression spiral tooling. The Polaris Compression Series has enhanced tooling geometry, which improves the cut quality, while achieving maximum productivity. Superior coating adhesion and performance is achieved through a pre-coating process that ensures durability and maximum tool life.

### Features and Benefits

- Advanced design geometry.
- Superior coating process.
- Reduced top and bottom layer delamination.
- Improved cut quality.
- Increased tooling longevity.



60-100PLR Series 2 Flute Compression Product Offering						
Part Number	Cutting DIA (in)	LoC (in)	Upcut LoC (in)	SHK DIA (in)	OAL (in)	Flutes
60-123PLR*	3/8	7/8	0.188	3/8	3	2
60-163PLR*	1/2	7/8	0.200	1/2	3	2
60-169PLR	1/2	1-1/8	0.562	1/2	3	2
60-173PLR*	1/2	1-3/8	0.200	1/2	3-1/2	2

\*MORTISE COMPRESSION

60-100PLR Series 3 Flute Compression Product Offering						
Part Number	Cutting DIA (in)	LoC (in)	Upcut LoC (in)	SHK DIA (in)	OAL (in)	Flutes
60-126PLR*	3/8	7/8	0.200	3/8	3	3
60-177PLR*	1/2	1-3/8	0.200	1/2	3-1/2	3

\*MORTISE COMPRESSION

60-100PLR Series Compression Product Offering-Metric						
Part Number	Cutting DIA (mm)	LoC (mm)	Upcut LoC (mm)	SHK DIA (mm)	OAL (mm)	Flutes
60-152PLR	6	22	4	6	64	1
60-153PLR	8	22	4	8	64	2
60-155PLR	10	22	4	10	76	2
60-156PLR	12	28	6	12	76	2

# 60-100MC Series Marathon Compression Spiral

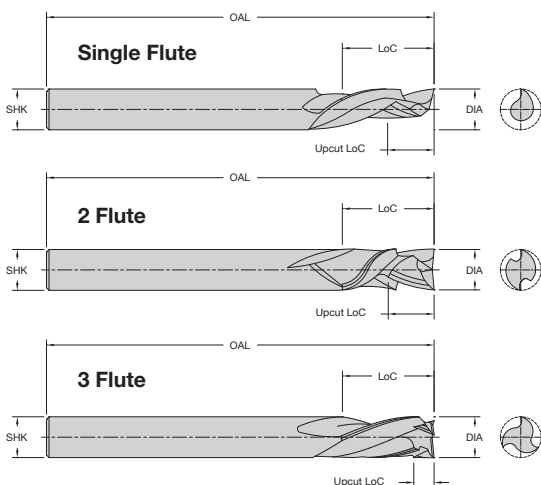
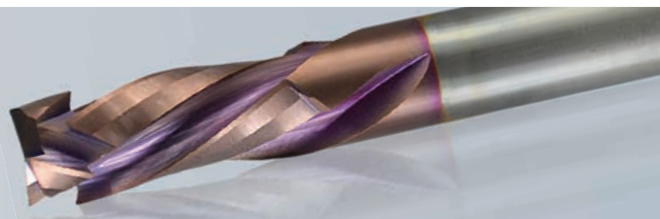

The LMT Onsrud Marathon is one of the longest running compression tools in the industry due to innovations in cutting tool geometry and the addition of a unique LMT Onsrud coating. The coating is formulated to protect the cutting edge from the high temperatures generated when routing laminated and composite wood products.

### Features and Benefits

- Progressive cutting edge geometry.
- Unique LMT Onsrud coating.
- Superior tool life and performance.
- Increased edge protection.

60-100MC Series 1 Flute Marathon Compression Product Offering						
Part Number	Cutting DIA (in)	LoC (in)	Upcut LoC (in)	SHK DIA (in)	OAL (in)	Flutes
60-111MC*	1/4	7/8	0.175	1/4	2-1/2	1
60-120MC*	3/8	1-1/8	0.200	3/8	3	1
60-162MC	1/2	1-1/8	0.594	1/2	3	1

\*MORTISE COMPRESSION

60-100MC Series 2 Flute Marathon Compression Product Offering						
Part Number	Cutting DIA (in)	LoC (in)	Upcut LoC (in)	SHK DIA (in)	OAL (in)	Flutes
60-113MC*	1/4	7/8	0.188	1/4	2-1/2	2
60-123MC*	3/8	7/8	0.200	3/8	3	2
60-124MC	3/8	1-1/8	0.406	3/8	3	2
60-127LMC*	3/8	1-1/8	0.200	3/8	3	2
60-163MC*	1/2	7/8	0.200	1/2	3	2
60-169MC	1/2	1-1/8	0.562	1/2	3	2
60-171MC	1/2	1-3/8	0.625	1/2	3-1/2	2
60-173MC*	1/2	1-3/8	0.200	1/2	3-1/2	2
60-173LMC*	1/2	1-3/8	0.200	1/2	3-1/2	2
60-172MC	1/2	1-5/8	0.750	1/2	4	2
60-172LMC	1/2	1-5/8	0.750	1/2	4	2

\*MORTISE COMPRESSION L=LEFT HAND

60-100MC Series 3 Flute Marathon Compression Product Offering						
Part Number	Cutting DIA (in)	LoC (in)	Upcut LoC (in)	SHK DIA (in)	OAL (in)	Flutes
60-126MC*	3/8	7/8	0.200	3/8	3	3
60-176MC*	1/2	7/8	0.200	1/2	3	3
60-177MC*	1/2	1-3/8	0.200	1/2	3-1/2	3
60-175MC	1/2	1-5/8	0.750	1/2	3-1/2	3

\*MORTISE COMPRESSION

60-100MC Series Marathon Compression Product Offering-Metric						
Part Number	Cutting DIA (mm)	LoC (mm)	Upcut LoC (mm)	SHK DIA (mm)	OAL (mm)	Flutes
60-152MC	6	22	4	6	64	1
60-153MC	8	22	4	8	64	2
60-155MC	10	22	4	10	76	2
60-156MC	12	28	6	12	76	2

Cutting data recommendations on page 39

# 60-100MW Series Max Life Compression Spiral

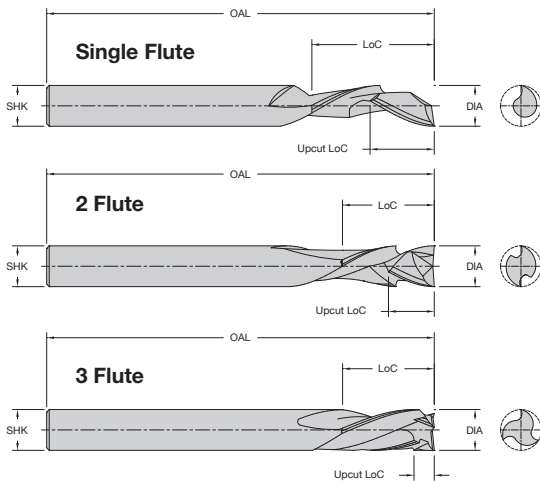
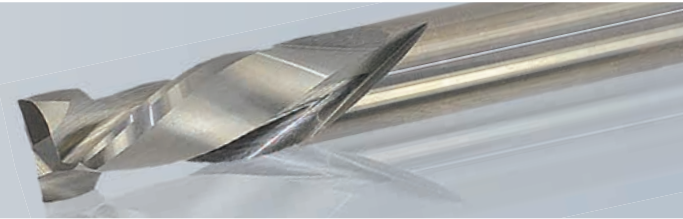

Designed for maximum life when cutting in highwear applications. Unique geometries and carbides improve the wear characteristics of the tool under abrasive applications with superior part finish. Mortise compressions are designed with short upcut to allow mortise cut with downcut action.

### 60-100MW Series Single Flute - Solid Carbide Max Life Compression Spiral Product Offering

Part Number	Cutting DIA (in)	LoC (in)	Upcut LoC (in)	SHK DIA (in)	OAL (in)	Flutes
60-102MW	1/8	3/8	.205	1/4	2-1/2	1
60-106MW	3/16	5/8	.300	1/4	2-1/2	1
60-111MW*	1/4	7/8	.175	1/4	2-1/2	1
60-120MW*	3/8	1-1/8	.200	3/8	3	1
60-167MW*	1/2	1-1/8	.200	1/2	3	1

HELIX ANGLE  $\approx 30^\circ$  \*MORTISE COMPRESSION

### 60-100MW Series Two Flute - Solid Carbide Max Life Compression Spiral Product Offering

Part Number	Cutting DIA (in)	LoC (in)	Upcut LoC (in)	SHK DIA (in)	OAL (in)	Flutes
60-113MW*	1/4	7/8	.188	1/4	2-1/2	2
60-123MW*	3/8	7/8	.188	3/8	3	2
60-124MW	3/8	1-1/8	.406	3/8	3	2
60-127MW*	3/8	1-1/8	.188	3/8	3	2
60-163MW*	1/2	7/8	.200	1/2	3	2
60-169MW	1/2	1-1/8	.562	1/2	3	2
60-171MW	1/2	1-3/8	.625	1/2	3-1/2	2
60-172MW	1/2	1-5/8	.750	1/2	4	2
60-173MW*	1/2	1-3/8	.200	1/2	3-1/2	2
60-181MW	1/2	2-1/8	1	1/2	5	2
60-186MW	5/8	2-1/4	1	5/8	5	2
60-196MW	3/4	1-7/8	.750	3/4	4	2
60-194MW	3/4	2-1/4	1	3/4	5	2

HELIX ANGLE  $\approx 30^\circ$  \*MORTISE COMPRESSION

### 60-100MW Series Three Flute - Solid Carbide Max Life Compression Spiral Product Offering

Part Number	Cutting DIA (in)	LoC (in)	Upcut LoC (in)	SHK DIA (in)	OAL (in)	Flutes
60-125MW	3/8	1-1/8	.500	3/8	3	3
60-126MW*	3/8	7/8	.200	3/8	3	3
60-176MW*	1/2	7/8	.200	1/2	3	3
60-177MW*	1/2	1-3/8	.200	1/2	3-1/2	3

\*MORTISE COMPRESSION

### 60-100MW Series Single & Two Flute - Solid Carbide Max Life Compression Spiral Product Offering - Metric

Part Number	Cutting DIA (mm)	LoC (mm)	Upcut LoC (mm)	SHK DIA (mm)	OAL (mm)	Flutes
60-152MW	6	22	4	6	64	1
60-153MW	8	22	4	8	64	2
60-155MW	10	22	4	10	76	2
60-156MW	12	28	6	12	76	2

# 60-100C Series Chipbreaker/Finisher Compression Spiral

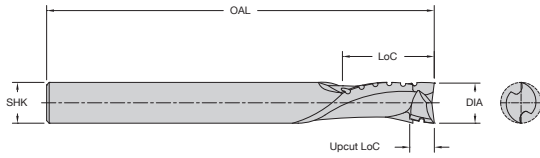
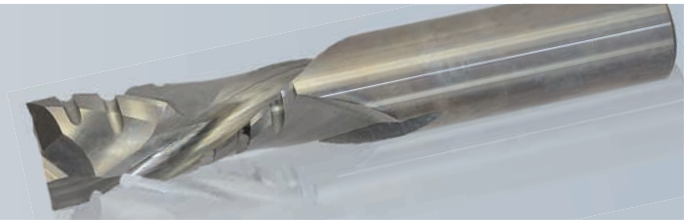

Designed to give the optimum edge finish of the compression spiral bits along with the increased feed rates of the chipbreaker/finisher design.

60-100C Series Two Flute - Solid Carbide Chipbreaker/Finisher Compression Spiral Product Offering

Part Number	Cutting DIA (in)	LoC (in)	Upcut LoC (in)	SHK DIA (in)	OAL (in)	Flutes
60-123C*	3/8	7/8	.188	3/8	3	2
60-124C	3/8	1-1/8	.406	3/8	3	2
60-163C*	1/2	7/8	.200	1/2	3	2
60-169C	1/2	1-1/8	.562	1/2	3	2
60-172C	1/2	1-5/8	.750	1/2	4	2

HELIX ANGLE  $\approx 30^\circ$

\*MORTISE COMPRESSION

# 60-200 Series Low Helix Finisher

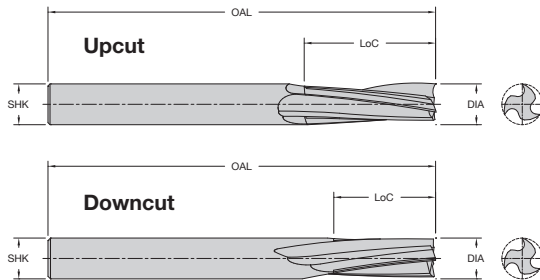

Designed for perfect balance and ultra smooth finish over a wide speed range.

60-200 Series Three Flute - Solid Carbide Low Helix Finisher ( <b>Upcut</b> ) Product Offering					
Part Number	Cutting DIA (in)	LoC (in)	SHK DIA (in)	OAL (in)	Flutes
60-239	1/4	3/8	1/4	3	3
60-241	1/4	7/8	1/4	3	3
60-243	3/8	5/8	3/8	3	3
60-245	3/8	1-1/8	3/8	3	3
60-249	1/2	1-1/8	1/2	3-1/2	3
60-253	1/2	1-5/8	1/2	4	3
60-251	1/2	2-1/8	1/2	4-1/2	3
60-269	3/4	1-5/8	3/4	4	3
60-271	3/4	2-1/8	3/4	5	3
60-277	3/4	3-1/8	3/4	6	3

HELIX ANGLE  $\approx 10^\circ$

60-200 Series Three Flute - Solid Carbide Low Helix Finisher ( <b>Downcut</b> ) Product Offering					
Part Number	Cutting DIA (in)	LoC (in)	SHK DIA (in)	OAL (in)	Flutes
60-240	1/4	3/8	1/4	3	3
60-242	1/4	7/8	1/4	3	3
60-244	3/8	5/8	3/8	3	3
60-246	3/8	1-1/8	3/8	3	3
60-250	1/2	1-1/8	1/2	3-1/2	3
60-254	1/2	1-5/8	1/2	4	3
60-252	1/2	2-1/8	1/2	4-1/2	3
60-270	3/4	1-5/8	3/4	5	3
60-272	3/4	2-1/8	3/4	5	3
60-278	3/4	3-1/8	3/4	6	3

HELIX ANGLE  $\approx 10^\circ$

60-200 Series Three Flute - Solid Carbide Low Helix Finisher Product Offering ( <b>Upcut</b> ) - Metric					
Part Number	Cutting DIA (mm)	LoC (mm)	SHK DIA (mm)	OAL (mm)	Flutes
60-471	8	25	8	76	3
60-473	10	35	10	76	3
60-475	12	35	12	88	3

HELIX ANGLE  $\approx 10^\circ$

# 60-300 Series Chipbreaker Finisher



For faster feed rates than a conventional two flute with a smooth finish.

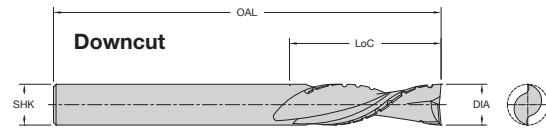
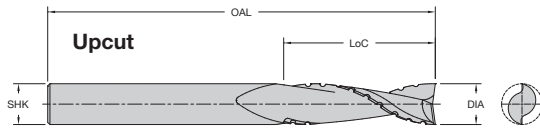

60-300 Series Two Flute - Solid Carbide Chipbreaker Finisher ( <b>Upcut</b> ) Product Offering					
Part Number	Cutting DIA (in)	LoC (in)	SHK DIA (in)	OAL (in)	Flutes
60-307	3/8	1-1/8	3/8	3	2
60-311	1/2	1-1/8	1/2	3	2
60-313	1/2	1-5/8	1/2	3-1/2	2
60-317	1/2	1-7/8	1/2	3-1/2	2
60-315	1/2	2-1/8	1/2	4	2
60-321	5/8	2-1/8	5/8	4	2
60-325	3/4	2-1/8	3/4	4	2

60-300 Series Two Flute - Solid Carbide Chipbreaker Finisher ( <b>Downcut</b> ) Product Offering					
Part Number	Cutting DIA (in)	LoC (in)	SHK DIA (in)	OAL (in)	Flutes
60-308	3/8	1-1/8	3/8	3	2
60-312	1/2	1-1/8	1/2	3	2
60-314	1/2	1-5/8	1/2	3-1/2	2
60-318	1/2	1-7/8	1/2	3-1/2	2
60-316	1/2	2-1/8	1/2	4	2
60-322	5/8	2-1/8	5/8	4	2
60-326	3/4	2-1/8	3/4	4	2

HELIX ANGLE  $\approx 30^\circ$

# 60-350 Series Chipbreaker Finisher

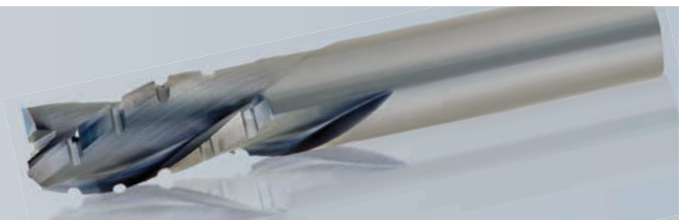

For additional balance at fast feed rates with a smooth finish.

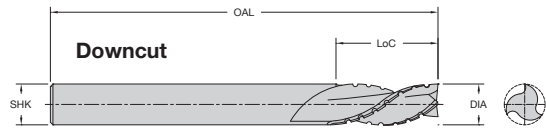
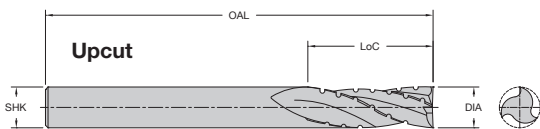

60-350 Series Three Flute - Solid Carbide Chipbreaker Finisher ( <b>Upcut</b> ) Product Offering					
Part Number	Cutting DIA (in)	LoC (in)	SHK DIA (in)	OAL (in)	Flutes
60-337	3/8	1-1/8	3/8	3	3
60-351	1/2	1-1/8	1/2	3	3
60-353	1/2	1-5/8	1/2	3-1/2	3
60-361	5/8	1-5/8	5/8	4	3
60-371	3/4	1-5/8	3/4	4	3
60-375	3/4	3-1/8	3/4	6	3

60-350 Series Three Flute - Solid Carbide Chipbreaker Finisher ( <b>Downcut</b> ) Product Offering					
Part Number	Cutting DIA (in)	LoC (in)	SHK DIA (in)	OAL (in)	Flutes
60-338	3/8	1-1/8	3/8	3	3
60-350	1/2	1-1/8	1/2	3	3
60-354	1/2	1-3/8	1/2	3-1/2	3
60-352	1/2	1-5/8	1/2	3-1/2	3
60-360	5/8	1-5/8	5/8	4	3
60-370	3/4	1-5/8	3/4	4	3
60-372	3/4	2-1/4	3/4	5	3
60-374	3/4	3-1/8	3/4	6	3

HELIX ANGLE  $\approx 30^\circ$

# 60-600 Series High Velocity Compression Spiral

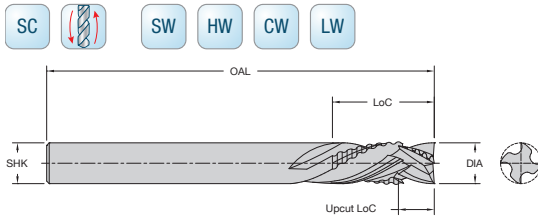

Combine a roughing and finishing cut in one tool for rapid feed rates with a good finish.

60-600 Series Four Flute - Solid Carbide High Velocity Compression Spiral Product Offering						
Part Number	Cutting DIA	LoC	Upcut LoC	SHK DIA	OAL	Flutes
60-669	1/2	1-1/8	.500	1/2	3	4
60-671	1/2	1-3/8	.500	1/2	3-1/2	4

HELIX ANGLE  $\approx 30^\circ$

# 60-700 Series High Velocity Spiral

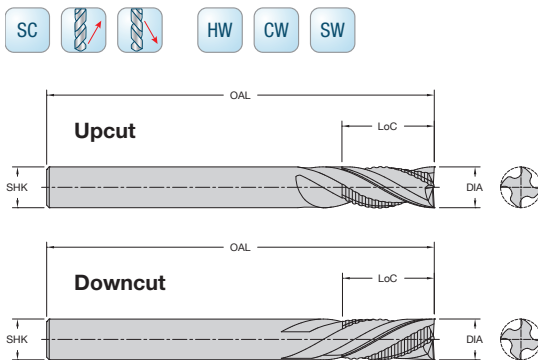

Combine a roughing and finishing cut with upcut cutting action in one tool for rapid feed rates with a good finish.

60-700 Series Four Flute - Solid Carbide High Velocity Spiral (Upcut) Product Offering						
Part Number	Cutting DIA (in)	LoC (in)	SHK DIA (in)	OAL (in)	Flutes	
60-711	1/2	1-1/8	1/2	3-1/2	4	
60-715	1/2	1-5/8	1/2	4	4	
60-719	1/2	2-1/8	1/2	4-1/2	4	
60-731	3/4	2-1/8	3/4	5	4	

HELIX ANGLE  $\approx 30^\circ$

60-700 Series Four Flute - Solid Carbide High Velocity Spiral (Downcut) Product Offering						
Part Number	Cutting DIA (in)	LoC (in)	SHK DIA (in)	OAL (in)	Flutes	
60-710	1/2	1-1/8	1/2	3-1/2	4	
60-714	1/2	1-5/8	1/2	4	4	
60-718	1/2	2-1/8	1/2	4-1/2	4	
60-720	5/8	2-1/8	5/8	5	4	

HELIX ANGLE  $\approx 30^\circ$



# 60-800 Series Rougher

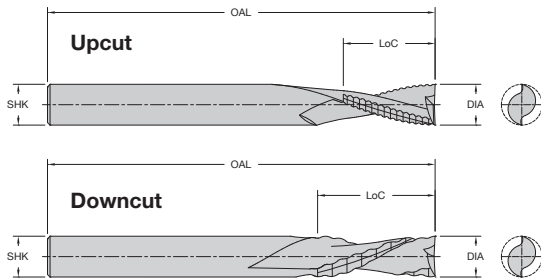
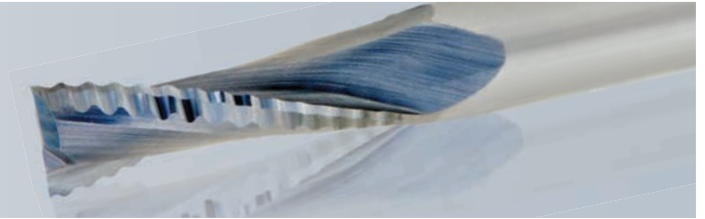

Designed for use when faster feed rates cannot be achieved, or on low horsepower machines.

## 60-800 Series Two Flute - Solid Carbide Rougher (Upcut) Product Offering

Part Number	Cutting DIA (in)	LoC (in)	SHK DIA (in)	OAL (in)	Flutes
60-815	3/8	1-3/8	3/8	3-1/2	2
60-825	1/2	1-3/8	1/2	3-1/2	2
60-829	1/2	1-7/8	1/2	4	2
60-841	5/8	2-5/8	5/8	5	2
60-847	3/4	2-7/8	3/4	6	2

HELIX ANGLE  $\approx 20^\circ$

## 60-800 Series Two Flute - Solid Carbide Rougher (Downcut) Product Offering

Part Number	Cutting DIA (in)	LoC (in)	SHK DIA (in)	OAL (in)	Flutes
60-816	3/8	1-3/8	3/8	3-1/2	2
60-826	1/2	1-3/8	1/2	3-1/2	2
60-830	1/2	1-7/8	1/2	4	2
60-842	5/8	2-5/8	5/8	5	2
60-848	3/4	2-7/8	3/4	6	2

# 60-900 Series Extreme Heavy Duty Hogger

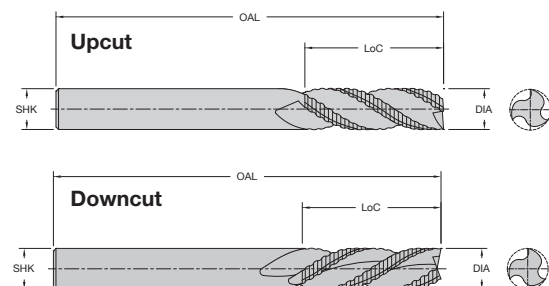

Designed for heavy material removal operations where the cutter is subject to excessive cutting forces and finish is not a primary concern.

## 60-900 Series Three Flute - Solid Carbide Extreme Heavy Duty Hogger (Upcut) Product Offering

Part Number	Cutting DIA (in)	LoC (in)	SHK DIA (in)	OAL (in)	Flutes
60-901	3/8	1-1/8	3/8	3	3
60-905	1/2	1-1/8	1/2	3	3
60-907	1/2	1-5/8	1/2	3-1/2	3
60-909	1/2	2-1/8	1/2	4	3
60-915	3/4	2-1/8	3/4	5	3

HELIX ANGLE  $\approx 30^\circ$

## 60-900 Series Three Flute - Solid Carbide Extreme Heavy Duty Hogger (Downcut) Product Offering

Part Number	Cutting DIA (in)	LoC (in)	SHK DIA (in)	OAL (in)	Flutes
60-902	3/8	1-1/8	3/8	3	3
60-906	1/2	1-1/8	1/2	3	3
60-908	1/2	1-5/8	1/2	3-1/2	3
60-910	1/2	2-1/8	1/2	4	3
60-916	3/4	2-1/8	3/4	5	3

# 60-950 Series Extreme Heavy Duty Chipbreaker/Finisher

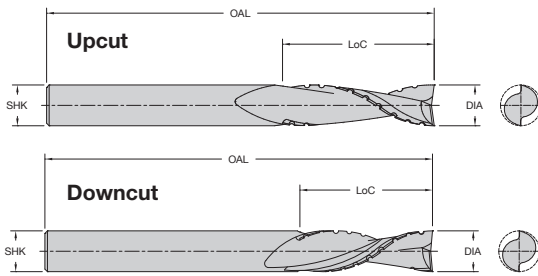

Designed to be fed very fast while withstanding excessive cutting forces and at the same time leaving a smooth finish.

60-950 Series Two Flute - Solid Carbide Extreme Heavy Duty Chipbreaker/Finisher ( <b>Upcut</b> ) Product Offering					
Part Number	Cutting DIA (in)	LoC (in)	SHK DIA (in)	OAL (in)	Flutes
60-951	3/8	1-1/8	3/8	3	2
60-955	1/2	1-1/8	1/2	3	2
60-957	1/2	1-5/8	1/2	3-1/2	2
60-959	1/2	2-1/8	1/2	4	2
60-965	3/4	2-1/8	3/4	5	2

HELIX ANGLE  $\approx 30^\circ$

60-950 Series Two Flute - Solid Carbide Extreme Heavy Duty Chipbreaker/Finisher ( <b>Downcut</b> ) Product Offering					
Part Number	Cutting DIA (in)	LoC (in)	SHK DIA (in)	OAL (in)	Flutes
60-950	3/8	1-1/8	3/8	3	2
60-954	1/2	1-1/8	1/2	3	2
60-956	1/2	1-5/8	1/2	3-1/2	2
60-958	1/2	2-1/8	1/2	4	2

# 61-000 Series Straight

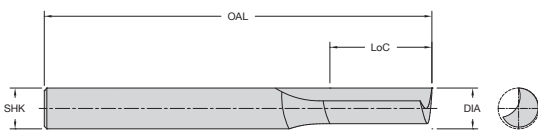
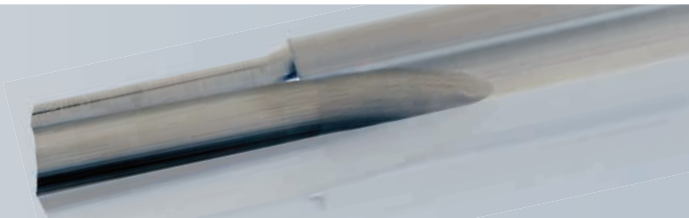

Designed to combine the fast free cutting of O flute geometry with the tool life available from solid carbide particularly in small diameters.

61-000 Series Single Flute - Solid Carbide <b>Straight</b> Product Offering					
Part Number	Cutting DIA (in)	LoC (in)	SHK DIA (in)	OAL (in)	Flutes
61-040	1/8	1/2	1/4	2	1
61-050	5/32	9/16	1/4	2	1
61-060	3/16	5/8	1/4	2	1
61-070	7/32	5/8	1/4	2-1/2	1
61-080	1/4	3/4	1/4	2-1/2	1
61-090	9/32	3/4	3/8	2-1/2	1
61-100	5/16	13/16	3/8	2-1/2	1
61-120	3/8	7/8	3/8	2-1/2	1
61-140	7/16	1	1/2	3	1
61-160	1/2	1	1/2	3	1

# 61-000P Series Straight

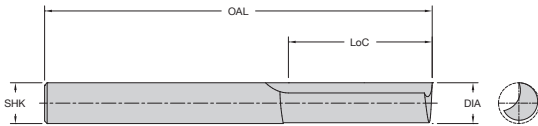
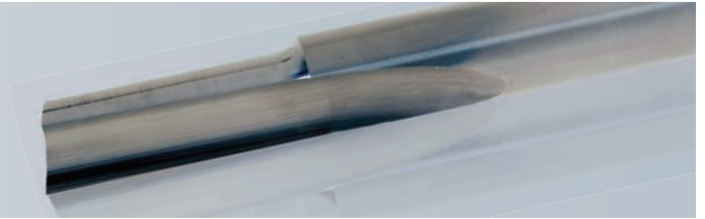

Designed to combine the fast free cutting of O flute geometry with the tool life available from solid carbide particularly in small diameters.

61-000P Series Single Flute - Solid Carbide **Straight** Product Offering

Part Number	Cutting DIA (in)	LoC (in)	SHK DIA (in)	OAL (in)	Flutes
61-041	1/8	5/16	1/4	2	1
61-044	1/8	1/2	1/8	2	1
61-042	1/8	1/2	1/4	2	1
61-042L	1/8	1/2	1/4	2	1
61-045	1/8	5/8	1/8	3	1
61-043	1/8	5/8	1/4	4	1
61-052	5/32	9/16	1/4	2	1
61-061	3/16	3/8	1/4	2	1
61-064	3/16	5/8	3/16	2-1/2	1
61-062	3/16	5/8	1/4	2	1
61-062L	3/16	5/8	1/4	2	1
61-063*	3/16	1	1/4	4	1
61-072	7/32	5/8	1/4	2-1/2	1
61-081	1/4	3/8	1/4	2-1/2	1
61-082	1/4	3/4	1/4	2-1/2	1
61-082L	1/4	3/4	1/4	2-1/2	1
61-083*	1/4	3/4	1/4	3-1/4	1
61-083L*	1/4	3/4	1/4	3-1/4	1
61-085*	1/4	1	1/4	3-1/4	1
61-084*	1/4	1-1/4	1/4	4	1
61-121	3/8	5/8	3/8	2-1/2	1
61-122	3/8	7/8	3/8	2-1/2	1
61-123*	3/8	1-5/8	3/8	6	1
61-162	1/2	1	1/2	3	1
61-164	1/2	1-5/8	1/2	4	1
61-166	1/2	2-1/8	1/2	6	1

\* These tools are designed and tolerated for air routers with guide bushings.  
L = Left hand rotation

## 61-200 Series Straight Wood Rout

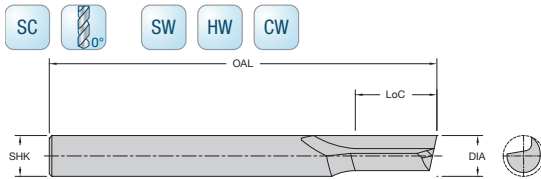
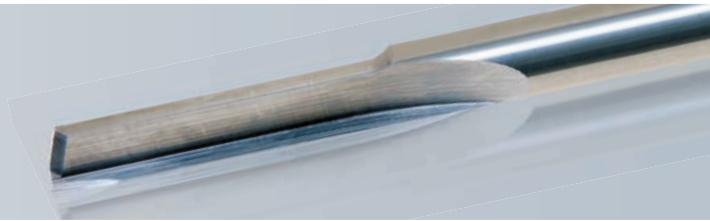

Designed to enhance operations where the benefits of spiral action are not needed. The single flute provides fast, free cutting with optimum cutter life.

61-200 Series Single Flute - Solid Carbide **Straight** Wood Rout Product Offering

Part Number	Cutting DIA (in)	LoC (in)	SHK DIA (in)	OAL (in)	Flutes
61-240	1/8	1/2	1/4	2	1
61-280	1/4	7/8	1/4	2-1/2	1
61-285	1/4	1	1/4	2-1/2	1
61-320	3/8	1-1/8	3/8	3	1

## 61-400 Series Straight

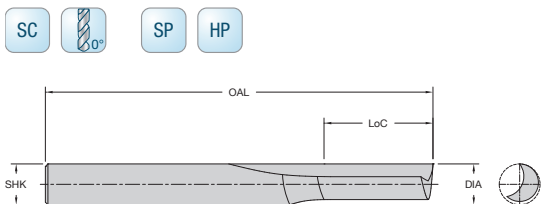
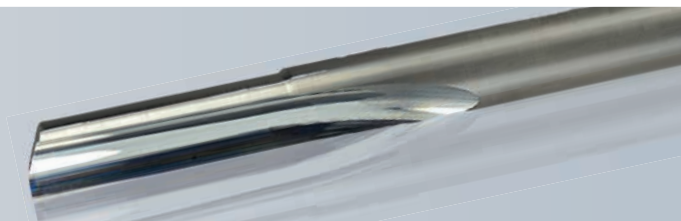

Designed to combine the fast free cutting of O flute geometry with the tool life available from solid carbide particularly in small diameters.

61-400 Series Single Flute - Solid Carbide **Straight** Product Offering - Metric

Part Number	Cutting DIA (mm)	LoC (mm)	SHK DIA (mm)	OAL (mm)	Flutes
61-410	4	16	6	64	1
61-411	5	20	6	64	1
61-412	6	25	6	64	1
61-414	8	25	8	64	1
61-418	12	35	12	88	1

## 62-600 Series Downcut Spiral O Flute

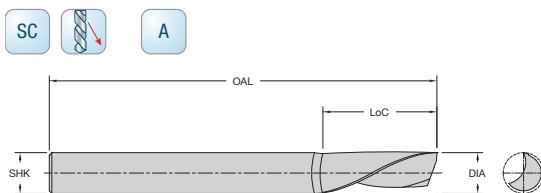
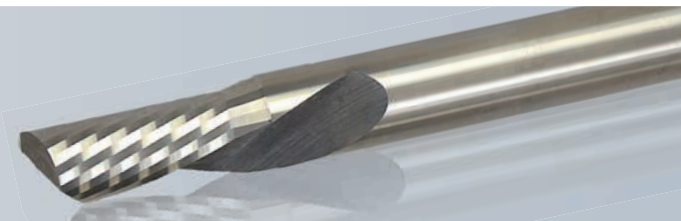

High speed cutters for machining aluminum sheet material. These tools are optimized for use on high-speed CNC mills, high speed machining centers and CNC routers.

62-600 Series Single Flute - Solid Carbide **Downcut** Spiral O Flute Product Offering

Part Number	Cutting DIA (in)	LoC (in)	SHK DIA (in)	OAL (in)	Flutes
62-602	1/16	1/4	1/8	1-1/2	1
62-604	1/8	1/4	1/8	1-1/2	1
62-606	1/8	1/4	1/4	2	1
62-610	1/8	1/2	1/4	2	1
62-614	3/16	3/8	1/4	2	1
62-620	1/4	3/8	1/4	2	1
62-622	1/4	3/4	1/4	2-1/2	1
62-624	1/4	1-1/4	1/4	3	1
62-630	5/16	3/4	1/2	3	1
62-625	3/8	3/4	3/8	3	1
62-631	1/2	1-1/8	1/2	3-1/2	1

HELIX ANGLE  $\approx 22^\circ$

# 62-700/62-750/62-800/62-850 Series Downcut Spiral O Flute



SC
62-700 HP SSP
62-750 SP HP SSP  
62-800 HP SSP
62-850 SP HP SSP

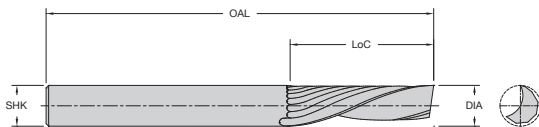

(HP) Designed to provide a smooth finish in hard plastics with downward chip removal.

(SP) Designed to provide a smooth finish in soft plastic with downward chip removal.

62-700/62-750 Series Single Flute - Solid Carbide **Downcut** Spiral O Flute Product Offering

Hard Plastic		Soft Plastic				
Part Number	Part Number	Cutting DIA (in)	LoC (in)	SHK DIA (in)	OAL (in)	Flutes
62-713*	62-763*	1/8	1/2	1/8	2	1
62-712*	62-762*	1/8	1/2	1/4	2	1
62-715*	-	5/32	9/16	1/4	2	1
62-719*	62-769*	3/16	5/8	3/16	2	1
62-718	62-768	3/16	5/8	1/4	2	1
62-725	62-775	1/4	3/4	1/4	2-1/2	1
62-726	62-776	1/4	1-1/4	1/4	3	1
62-727*	-	1/4	1-1/2	1/4	3	1
62-733	62-783	3/8	1-1/8	3/8	3	1
62-740	62-790	1/2	1-5/8	1/2	3-1/2	1

\*Tool balanced by design to run at spindle speeds up to 60,000 RPM

62-800/62-850 Series Single Flute - Solid Carbide **Downcut** Spiral O Flute Product Offering - Metric

Hard Plastic		Soft Plastic				
Part Number	Part Number	Cutting DIA (mm)	LoC (mm)	SHK DIA (mm)	OAL (mm)	Flutes
62-816*	62-866*	3	12	6	64	1
62-824*	62-874*	4	20	6	64	1
62-830	62-880	5	16	6	64	1
62-840	-	6	30	6	76	1
62-842*	-	6	38	6	76	1
62-844	-	8	25	8	64	1
62-846	62-896	8	38	8	76	1

HELIX ANGLE  $\approx 21^\circ$

\*Tool balanced by design to run at spindle speeds up to 60,000 RPM

# 63-000 Series Upcut Spiral

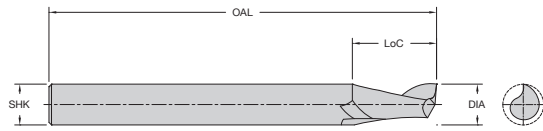
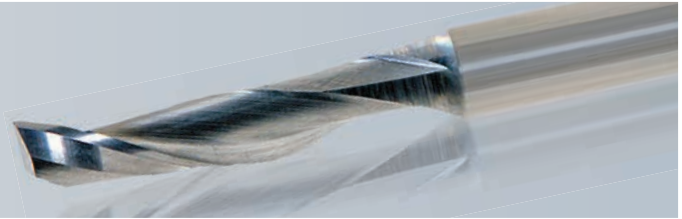

Designed for routing where upward chip removal, tool rigidity, long life, and high quality finish is desired.

63-000 Series Single Flute - Solid Carbide <b>Upcut</b> Spiral Product Offering					
Part Number	Cutting DIA (in)	LoC (in)	SHK DIA (in)	OAL (in)	Flutes
63-040	1/8	1/2	1/4	2	1
63-050	5/32	9/16	1/4	2	1
63-060	3/16	5/8	1/4	2	1
63-080	1/4	3/4	1/4	2-1/2	1
63-100	5/16	13/16	3/8	2-1/2	1
63-160	1/2	1	1/2	3	1

HELIX ANGLE  $\approx 30^\circ$

## 63-200 Series Upcut Spiral Wood Rout

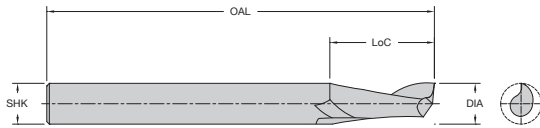
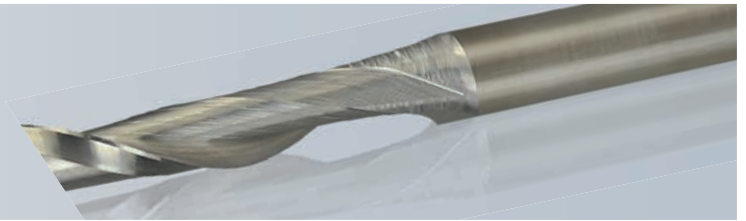

Designed for routing where aggressive upward chip removal is necessary in hand-fed or CNC applications. Tool rigidity, long life, and high quality finish are characteristic of these tools.

63-200 Series Single Flute - Solid Carbide **Upcut** Spiral Wood Rout Product Offering

Part Number	Cutting DIA (in)	LoC (in)	SHK DIA (in)	OAL (in)	Flutes
63-240	1/8	1/2	1/4	2	1
63-280	1/4	7/8	1/4	2-1/2	1

HELIX ANGLE  $\approx 30^\circ$

## 63-400 Series Upcut for Soft Aluminum

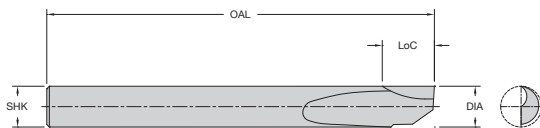
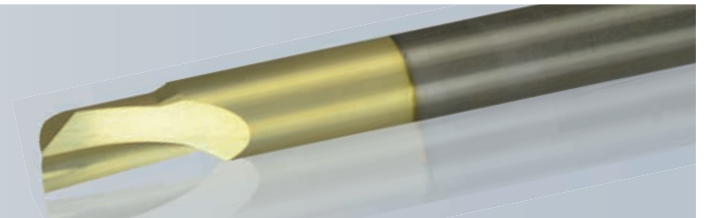

These tools are specially designed to cut soft grades of aluminum and create a good edge finish. The improved cutting geometry properly forms and evacuates the chips preventing chip rewelding.

63-400 Series Single Flute - Solid Carbide **Upcut** for Soft Aluminum (Coated) Product Offering

Part Number	Cutting DIA	LoC	SHK DIA	OAL	Coating	Flutes
63-420	3/16	1/4	1/4	2	ZRN	1
63-430	1/4	1/4	1/4	2	ZRN	1

63-400 Series Single Flute - Solid Carbide **Upcut** for Soft Aluminum (Coated) Product Offering - Metric

Part Number	Cutting DIA	LoC	SHK DIA	OAL	Coating	Flutes
63-450	5	6	6	64	ZRN	1
63-460	6	6	6	64	ZRN	1

Cutting Parameters

Part Number	RPM	Feed Rate
63-420	13,250	100 IPM
63-430	10,000	80 IPM
63-450	13,250	100 IPM
63-460	10,000	80 IPM

## 63-500 Series Upcut Spiral O Flute for Acrylic

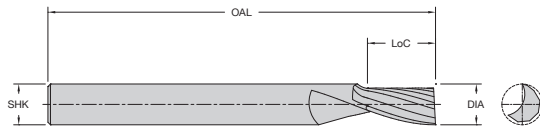
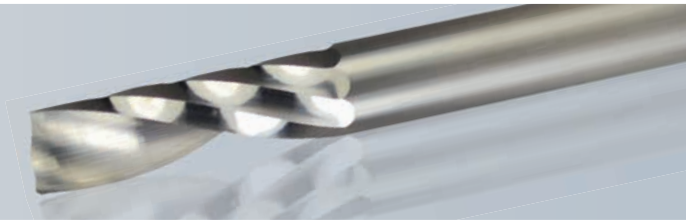

These tools are designed to cut acrylics and achieve long tool life. Our unique cutting geometry produces a smooth edge finish regardless if it is cast or extruded acrylic.

63-500 Series Single Flute - Solid Carbide **Upcut** Spiral O Flute for Acrylic Product Offering

Part Number	Cutting DIA (in)	LoC (in)	SHK DIA (in)	OAL (in)	Flutes
63-505*	1/16	1/4	1/4	2	1
63-510	1/8	1/4	1/4	2	1
63-515*	1/8	1/2	1/4	2	1
63-520*	3/16	5/8	1/4	2	1
63-525	1/4	3/8	1/4	2-1/2	1
63-530	1/4	3/4	1/4	2-1/2	1
63-535	3/8	1-1/8	3/8	3	1

\*Tool balanced by design to run at spindle speeds up to 60,000 RPM

## 63-600 Series Upcut Spiral O Flute

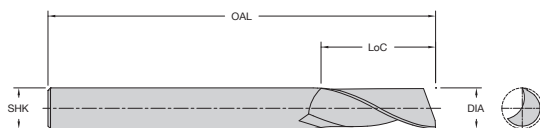
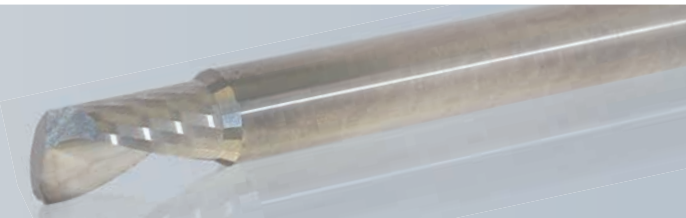

High speed cutters for machining aluminum sheet and block material. These tools are optimized for use on high-speed CNC mills, high speed machining centers and CNC routers.

63-600 Series Single Flute - Solid Carbide **Upcut** Spiral O Flute Product Offering

Part Number	Cutting DIA (in)	LoC (in)	SHK DIA (in)	OAL (in)	Flutes
63-602	1/16	1/4	1/8	1-1/2	1
63-603	3/32	1/4	1/8	2	1
63-604	1/8	1/4	1/8	1-1/2	1
63-606	1/8	1/4	1/4	2	1
63-610	1/8	1/2	1/4	2	1
63-611	5/32	5/16	3/16	2	1
63-612	3/16	3/8	3/16	1-1/2	1
63-614	3/16	3/8	1/4	2	1
63-618	3/16	5/8	1/4	2	1
63-620	1/4	3/8	1/4	2	1
63-622	1/4	3/4	1/4	2-1/2	1
63-624	1/4	1-1/4	1/4	3	1
63-629	5/16	9/16	5/16	2-1/2	1
63-630	5/16	3/4	1/2	3	1
63-634	21/64	3/4	1/2	3	1
63-625	3/8	3/4	3/8	3	1
63-626	3/8	1-1/8	3/8	3	1
63-627	3/8	1-3/8	3/8	3-1/2	1
63-631	1/2	1-1/8	1/2	3-1/2	1
63-632	1/2	1-3/8	1/2	3-1/2	1

HELIX ANGLE ≈ 22°



# 63-700/63-750/63-800/63-850 Series Upcut Spiral O Flute



SC
63-700 HP SSP
63-750 SP HP SSP  
63-800 HP SSP
63-850 SP HP SSP

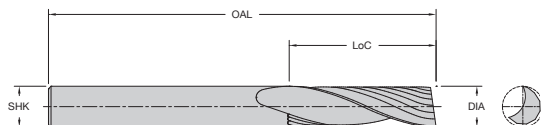

(HP) Designed to provide a smooth finish in hard plastics with upward chip removal.

(SP) Designed to provide a smooth finish in soft plastic with upward chip removal.

63-700/63-750 Series Single Flute - Solid Carbide <b>Upcut</b> Spiral O Flute Product Offering								
Hard Plastic	Soft Plastic	Part Number	Part Number	Cutting DIA (in)	LoC (in)	SHK DIA (in)	OAL (in)	Flutes
		63-701*	63-751*	1/16	1/4	1/8	2	1
		63-700*	63-750*	1/16	1/4	1/4	2	1
		63-706*	—	1/8	5/8	1/4	2-1/2	1
		63-707*	—	1/8	3/4	1/4	2-1/2	1
		63-711*	63-761*	1/8	1/4	1/8	2	1
		63-710*	63-760*	1/8	1/4	1/4	2	1
		63-713*	63-763*	1/8	1/2	1/8	2	1
		63-712*	63-762*	1/8	1/2	1/4	2	1
		63-743* <sup>2</sup>	63-793* <sup>2</sup>	1/8	1/2	1/4	2	1
		63-715*	—	5/32	9/16	1/4	2	1
		63-716*	63-766*	3/16	3/8	3/16	2	1
		63-717*	63-767*	3/16	3/8	1/4	2	1
		63-719*	63-769*	3/16	5/8	3/16	2	1
		63-718*	63-768*	3/16	5/8	1/4	2	1
		63-720	—	7/32	3/4	1/4	2-1/2	1
		63-724	63-774	1/4	3/8	1/4	2	1
		63-744 <sup>2</sup>	63-794 <sup>2</sup>	1/4	3/4	1/4	2-1/2	1
		63-725	63-775	1/4	3/4	1/4	2-1/2	1
		63-726	63-776	1/4	1-1/4	1/4	3	1
		63-727*	63-777	1/4	1-1/2	1/4	3	1
		63-730	63-780	3/8	5/8	3/8	2-1/2	1
		63-731	63-781	3/8	3/4	3/8	3	1
		63-733	63-783	3/8	1-1/8	3/8	3	1
		63-735	63-785	3/8	1-5/8	3/8	3-1/2	1
		63-745 <sup>2</sup>	63-795 <sup>2</sup>	3/8	1-5/8	3/8	3-1/2	1
		63-740	63-790	1/2	1-5/8	1/2	3-1/2	1
		63-746 <sup>2</sup>	63-796 <sup>2</sup>	1/2	1-5/8	1/2	3-1/2	1

HELIX ANGLE ≈ 21°

<sup>2</sup> Special Point for Improved Bottom Finish

63-800/63-850 Series Single Flute - Solid Carbide <b>Upcut</b> Spiral O Flute Product Offering - Metric								
Hard Plastic	Soft Plastic	Part Number	Part Number	Cutting DIA (mm)	LoC (mm)	SHK DIA (mm)	OAL (mm)	Flutes
		63-802	—	2	8	2	50	1
		63-804*	63-854*	2	8	6	64	1
		63-806	—	2.5	8	2.5	50	1
		63-808*	—	2.5	8	6	64	1
		63-810*	63-860*	3	8	3	50	1
		63-812*	63-862*	3	8	6	64	1
		63-814*	63-864*	3	12	3	64	1
		63-816*	63-866*	3	12	6	64	1
		63-818*	—	4	8	4	64	1
		63-820*	63-870*	4	12	4	64	1
		63-822*	—	4	20	4	64	1
		63-824*	63-874*	4	20	6	64	1
		63-826*	—	4	30	4	64	1
		63-828	63-878*	5	16	5	64	1
		63-830	63-880	5	16	6	64	1
		63-832*	—	5	30	5	64	1
		63-834	—	6	8	6	64	1
		63-836	63-886	6	12	6	64	1
		63-838	63-888	6	20	6	64	1
		63-840	—	6	30	6	76	1
		63-842*	63-892*	6	38	6	76	1
		63-844	63-894	8	25	8	64	1
		63-846	63-896	8	38	8	76	1
		63-848	63-898	10	30	10	76	1
		63-849	—	10	35	10	76	1
		63-847	63-897	12	38	12	76	1

HELIX ANGLE ≈ 21°

\*Tool balanced by design to run at spindle speeds up to 60,000 RPM

## 63-900 Series Upcut Spiral O Flute

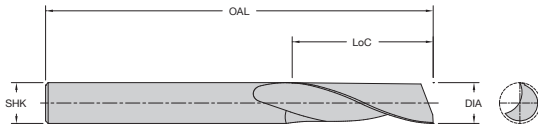
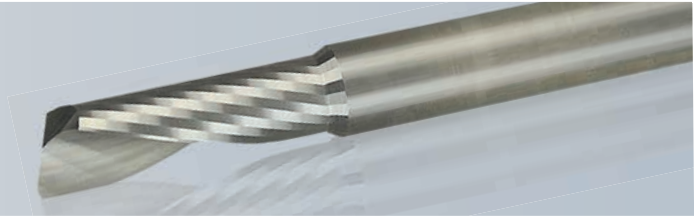

High speed cutters for machining aluminum sheet and block material. These tools are optimized for use on high-speed CNC mills, high speed machining centers and CNC routers.

63-900 Series Single Flute - Solid Carbide <b>Upcut</b> Spiral O Flute Product Offering - Metric					
Part Number	Cutting DIA (mm)	LoC (mm)	SHK DIA (mm)	OAL (mm)	Flutes
63-904	2	6	6	64	1
63-908	2.5	6	6	64	1
63-912	3	8	6	64	1
63-916	3	12	6	64	1
63-918	4	8	4	64	1
63-924	4	20	6	64	1
63-930	5	16	6	64	1
63-934	6	8	6	64	1
63-938	6	20	6	64	1
63-944	8	25	8	64	1
63-946	8	38	8	76	1
63-948	10	30	10	76	1

HELIX ANGLE ≈ 22°

## 64-000 Series Downcut Spiral Super O

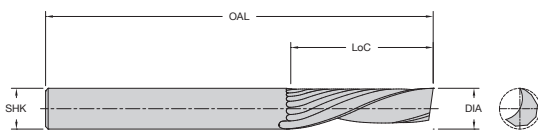
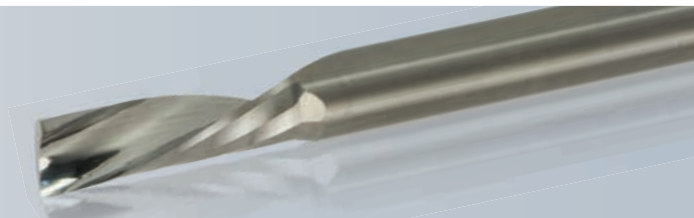

The polished flute allows for razor sharp cutting edge and easy chip evacuation. The tool is available in a down cut spiral for improved part holding.

64-000 Series Single Flute - Solid Carbide <b>Downcut</b> Spiral O Flute Product Offering					
Part Number	Cutting DIA (in)	LoC (in)	SHK DIA (in)	OAL (in)	Flutes
64-000*	1/16	1/4	1/8	2	1
64-012*	1/8	1/2	1/4	2	1
64-016*	3/16	3/8	3/16	2	1
64-018	3/16	5/8	1/4	2	1
64-024	1/4	3/8	1/4	2	1
64-025	1/4	3/4	1/4	2	1
64-026	1/4	1-1/4	1/4	3	1
64-031	3/8	3/4	3/8	3	1
64-033	3/8	1-1/8	3/8	3	1

HELIX ANGLE ≈ 21°

64-000 Series Single Flute - Solid Carbide <b>Downcut</b> Spiral O Flute Product Offering - Metric					
Part Number	Cutting DIA (mm)	LoC (mm)	SHK DIA (mm)	OAL (mm)	Flutes
64-012M	3	12	6	50	1
64-026M	6	32	6	76	1

HELIX ANGLE ≈ 21°

\*Tool balanced by design to run at spindle speeds up to 60,000 RPM

# 65-000 Series Upcut Spiral Super O

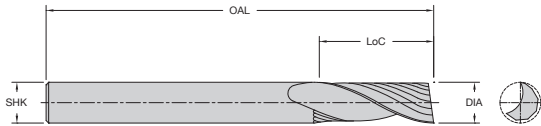
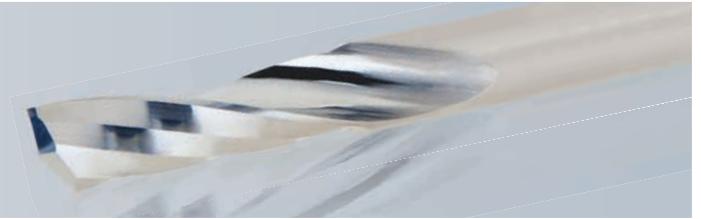

The polished flute allows for razor sharp cutting edge and easy chip evacuation. The tool is available in a upcut spiral for improved chip evacuation.

65-000 Series Single Flute - Solid Carbide <b>Upcut</b> Spiral O Flute Product Offering					
Part Number	Cutting DIA (in)	LoC (in)	SHK DIA (in)	OAL (in)	Flutes
65-000*	1/16	1/4	1/8	2	1
65-010*	1/8	1/4	1/4	2	1
65-013*	1/8	1/2	1/8	2	1
65-012*	1/8	1/2	1/4	2	1
65-019*	3/16	5/8	3/16	2	1
65-018*	3/16	5/8	1/4	2	1
65-020*	3/16	1-1/4	1/4	3	1
65-021*	3/16	7/8	1/4	2-1/2	1
65-023	1/4	5/8	1/4	2	1
65-025	1/4	7/8	1/4	2-1/2	1
65-026	1/4	1-1/4	1/4	3	1
65-027*	1/4	1-1/2	1/4	3	1
65-033	3/8	1-1/8	3/8	3	1

HELIX ANGLE ≈ 21°

65-000 Series Single Flute - Solid Carbide <b>Upcut</b> Spiral O Flute Product Offering - Metric					
Part Number	Cutting DIA (mm)	LoC (mm)	SHK DIA (mm)	OAL (mm)	Flutes
65-000M	2	6	3	50	1
65-018M	5	16	6	64	1
65-023M	6	16	6	64	1
65-033M	10	29	10	76	1

HELIX ANGLE ≈ 22°

**\*Tool balanced by design to run at spindle speeds up to 60,000 RPM**

# 65-200B/65-300B Series High Finish Ballnose

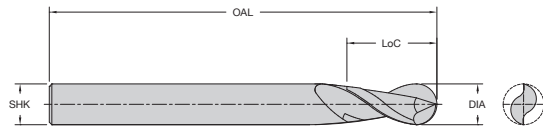
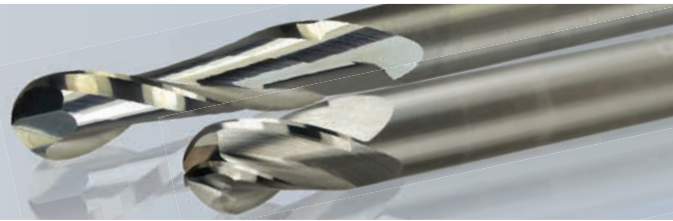

The tool's unique geometry, specially designed point, and highly polished primary clearance and flute gives the tool the ability to attain a surface finish of 28 Ra in mechanical plastic.

65-200B Series Two Flute - High Finish Ballnose for Plastics Product Offering

Part Number	Cutting DIA (in)	LoC (in)	SHK DIA (in)	OAL (in)	Flutes
65-205B	1/16	1/4	1/8	2	2
65-210B	1/8	1/2	1/8	2-1/2	2
65-215B	3/16	1/2	1/4	2-1/2	2
65-220B	1/4	1/2	1/4	2-1/2	2
65-225B	1/4	1-1/8	1/4	3	2
65-235B	5/16	1/2	5/16	3	2
65-240B	5/16	1-1/8	5/16	3	2
65-250B	3/8	1-1/8	3/8	3	2
65-260B	1/2	1-1/8	1/2	3	2

65-200B Series Two Flute - High Finish Ballnose for Plastics Product Offering - Metric

Part Number	Cutting DIA (mm)	LoC (mm)	SHK DIA (mm)	OAL (mm)	Flutes
65-280B	3	12	3	64	2
65-285B	6	20	6	76	2
65-290B	8	25	8	76	2
65-295B	10	30	10	76	2

65-300B Series Four Flute - High Finish Ballnose for Plastics Product Offering

Part Number	Cutting DIA (in)	LoC (in)	SHK DIA (in)	OAL (in)	Flutes
65-310B	1/4	1/2	1/4	3	4
65-315B	5/16	1/2	5/16	3	4
65-320B	3/8	5/8	3/8	3	4
65-325B	1/2	3/4	1/2	3	4

# 66-000 Series Edge Rounding



Designed for rounding the edge of sheets or parts. They come in both single flute and double flute.

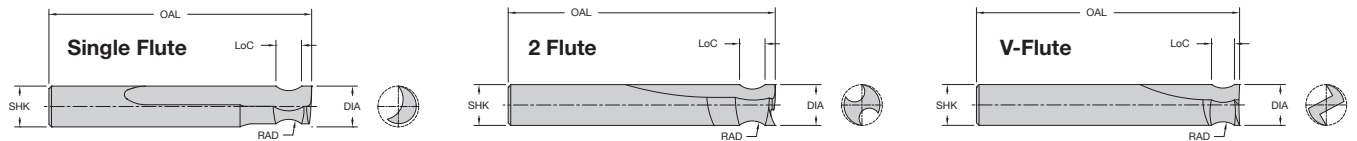

### 66-000 Series Single Flute **Straight** O-Flute Product Offering

Part Number	Cutting DIA (inch)	LoC (inch)	Shank DIA (inch)	OAL (inch)	Opening (inch)	Radius (inch)	Small Flute LGTH (inch)	Tip To RAD (inch)	Plastic Size (inch)	Flutes
66-082	1/4	3/8	1/4	2-1/2	5/32	1/8	.195	1/16	1/8	1
66-083	1/4	3/8	1/4	2-1/2	7/32	3/16	.180	1/16	3/16	1
66-084	1/4	3/8	1/4	2-1/2	9/32	1/4	.163	1/16	1/4	1

### 66-000 Series Single Flute **Spiral** O-Flute Product Offering

Part Number	Cutting DIA (inch)	LoC (inch)	Shank DIA (inch)	OAL (inch)	Opening (inch)	Radius (inch)	Small Flute LGTH (inch)	Tip To RAD (inch)	Plastic Size (inch)	Flutes
66-085	1/4	3/8	1/4	2-1/2	5/32	1/8	.195	1/16	1/8	1
66-086	1/4	3/8	1/4	2-1/2	7/32	3/16	.180	1/16	3/16	1
66-087	1/4	3/8	1/4	2-1/2	9/32	1/4	.163	1/16	1/4	1

HELIX ANGLE = 22°

### 66-000 Series Two Flute **Straight** O-Flute Product Offering

Part Number	Cutting DIA (inch)	LoC (inch)	Shank DIA (inch)	OAL (inch)	Opening (inch)	Radius (inch)	Small Flute LGTH (inch)	Tip To RAD (inch)	Plastic Size (inch)	Flutes
66-092	1/4	3/8	1/4	2-1/2	5/32	1/8	.195	1/16	1/8	2
66-093	1/4	3/8	1/4	2-1/2	7/32	3/16	.180	1/16	3/16	2
66-094	1/4	3/8	1/4	2-1/2	9/32	1/4	.163	1/16	1/4	2

### 66-000 Series Two Flute **Straight** V-Flute Product Offering

Part Number	Cutting DIA (inch)	LoC (inch)	Shank DIA (inch)	OAL (inch)	Opening (inch)	Radius (inch)	Small Flute LGTH (inch)	Tip To RAD (inch)	Plastic Size (inch)	Flutes
66-120	3/8	3/8	3/8	2-1/2	5/32	1/8	.320	1/16	1/8	2
66-121	3/8	3/8	3/8	2-1/2	7/32	3/16	.305	1/16	3/16	2
66-122	3/8	3/8	3/8	2-1/2	9/32	1/4	.288	1/16	1/4	2
66-123	3/8	1/2	3/8	2-1/2	13/32	3/8	.255	1/16	3/8	2
66-160	1/2	3/8	1/2	3	5/32	1/8	.445	1/16	1/8	2
66-161	1/2	3/8	1/2	3	7/32	3/16	.430	1/16	3/16	2
66-162	1/2	3/8	1/2	3	9/32	1/4	.413	1/16	1/4	2
66-163	1/2	5/8	1/2	3	17/32	1/2	.347	1/16	1/2	2

## 66-200 Series Rout and Chamfer

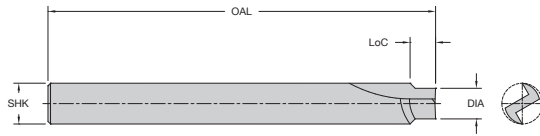
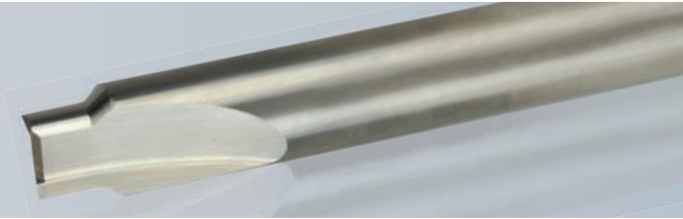

Designed to provide up to a 1/16" top face chamfer and a finished side edge on plastic sheets or parts.

66-200 Series Two Flute - Solid Carbide Rout and Chamfer Product Offering

Part Number	Cutting DIA (in)	LoC (in)	SHK DIA (in)	OAL (in)	Material Thickness (in)	Flutes
66-200	1/4	3/16	3/8	2-1/4	1/8	2
66-204	1/4	1/4	3/8	2-1/4	3/16	2
66-210	3/8	5/16	1/2	3	1/4	2

HELIX ANGLE ≈ 0°

## 66-300 Series Upcut Bottom Surfacing

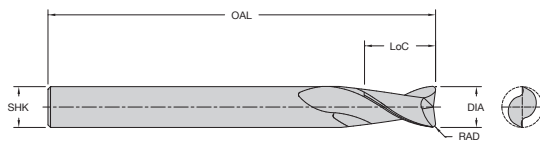
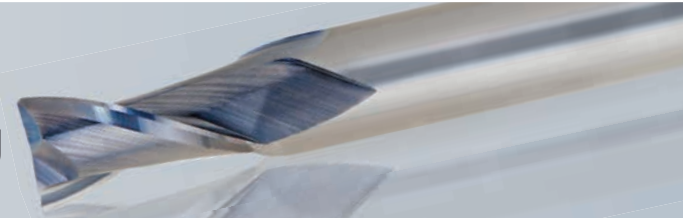

Designed for pocketing applications where the bottom of the pocket must be smooth.

66-300 Series Two Flute - Solid Carbide **Upcut** Bottom Surfacing Product Offering

Part Number	Cutting DIA (in)	Corner Radius (in)	LoC (in)	SHK DIA (in)	OAL (in)	Flutes
66-308	1/8	.020	1/4	1/4	2	2
66-309	1/8	.002	1/4	1/4	2	2
66-314	1/4	.030	3/8	1/4	2	2
66-315	1/4	.002	3/8	1/4	2	2
66-320	3/8	.030	5/8	3/8	2-1/2	2
66-321	3/8	.002	5/8	3/8	2-1/2	2
66-326	1/2	.030	7/8	1/2	3	2
66-327	1/2	.002	7/8	1/2	3	2
66-328	3/4	.040	1-1/8	3/4	4	2

HELIX ANGLE ≈ 30°

# 66-400 Series Compression

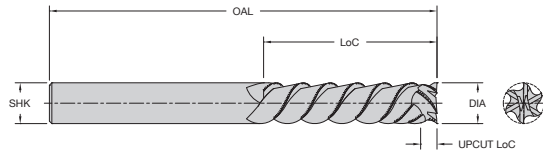
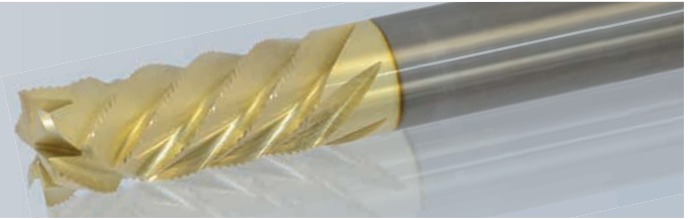

66-400 Series Solid Carbide Honeycomb Compression Product Offering

Part Number	Cutting DIA (in)	LoC (in)	Upcut LoC (in)	SHK DIA (in)	OAL (in)	Flutes
66-405	3/8	1-1/8	0.250	3/8	3	6
66-410	1/2	1-1/8	0.300	1/2	3	6
66-415	1/2	2-1/8	0.300	1/2	4	6

Designed for routing Falcon Board®, BioBoard™, Reboard® or similar materials used for graphic display boards. Single pass solution when machining Aluminum and Paper Based (Nomex®) sandwich panels.

### CUTTING PARAMETERS HONEYCOMB CORE AND SANDWICH PANEL

Aluminum Facings w/Aluminum Core	
RPM	Feed Rate
18,000	90-120 IPM

Fiberglass Facings w/Paper Core (Nomex®)	
RPM	Feed Rate
12,000-15,000	90-120 IPM

Cardboard Honeycomb	
RPM	Feed Rate
20,000	60 IPM

# 66-500 Series DFC Multi-Flute Composite Router

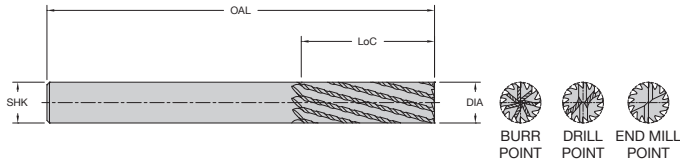
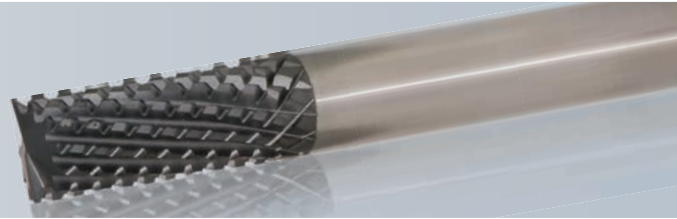

Designed to put you in control, LMT Onsrud's 66-500 Series DFC Multi-Flute Composite Routers give you options at the spindle to deliver results that are as efficient as they are precise. Use the 66-500 Series for roughing or finishing on carbon fiber laminates.

### Features and Benefits

- Multiple flutes eliminate vibration and control tool engagement.
- Chisel tooth design creates a compression effect to prevent delamination and fiber breakout.
- Enhanced diamond film coating (DFC) for increased tool life.

### Available in three point styles

- Burr end for ramping and helical interpolation.
- End mill point for plunging and helical interpolation.
- Drill point for drilling.

Part Number	Cutting DIA (mm)	LoC (mm)	SHK DIA (mm)	OAL (mm)	Flutes	Point Style
66-570	3	8	6	50	6	End Mill
66-572	3	8	6	50	6	Drill
66-574	4	11	6	50	6	End Mill
66-576	4	11	6	50	6	Drill
66-578	5	13	6	50	8	End Mill
66-580	5	13	6	50	8	Drill
66-582	6	13	6	50	10	End Mill
66-584	6	13	6	50	10	Drill
66-586	8	19	8	63	12	End Mill
66-588	8	19	8	63	12	Drill
66-590	10	22	10	72	12	End Mill
66-592	10	22	10	72	12	Drill
66-594	12	26	12	83	14	End Mill
66-596	12	26	12	83	14	Drill

Part Number	Cutting DIA (in)	LoC (in)	SHK DIA (in)	OAL (in)	Flutes	Point Style
66-501	1/8	1/4	1/8	2	6	Burr
66-502	1/8	1/4	1/8	2	6	End Mill
66-505	1/8	1/2	1/8	2	6	Burr
66-506	1/8	1/2	1/8	2	6	End Mill
66-507	1/8	1/2	1/8	2	6	Drill
66-509	3/16	3/8	3/16	2	8	Burr
66-510	3/16	3/8	3/16	2	8	End Mill
66-513	3/16	3/4	3/16	2-1/2	8	Burr
66-514	3/16	3/4	3/16	2-1/2	8	End Mill
66-515	3/16	3/4	3/16	2-1/2	8	Drill
66-517	1/4	1/2	1/4	2-1/2	10	Burr
66-518	1/4	1/2	1/4	2-1/2	10	End Mill
66-521	1/4	3/4	1/4	2-1/2	10	Burr
66-522	1/4	3/4	1/4	2-1/2	10	End Mill
66-525	1/4	1	1/4	3	10	Burr
66-526	1/4	1	1/4	3	10	End Mill
66-527	1/4	1	1/4	3	10	Drill
66-529	1/4	1-1/4	1/4	4	10	Burr
66-530	1/4	1-1/4	1/4	4	10	End Mill
66-533	3/8	3/4	3/8	2-1/2	12	Burr
66-534	3/8	3/4	3/8	2-1/2	12	End Mill
66-537	3/8	1-1/8	3/8	3	12	Burr
66-538	3/8	1-1/8	3/8	3	12	End Mill
66-539	3/8	1-1/8	3/8	3	12	Drill
66-541	3/8	1-1/4	3/8	3	12	Burr
66-542	3/8	1-1/4	3/8	3	12	End Mill
66-545	3/8	1-1/2	3/8	4	12	Burr
66-546	3/8	1-1/2	3/8	4	12	End Mill
66-549	1/2	1	1/2	3	14	Burr
66-550	1/2	1	1/2	3	14	End Mill
66-551	1/2	1	1/2	3	14	Drill
66-553	1/2	1-1/2	1/2	4	14	Burr
66-554	1/2	1-1/2	1/2	4	14	End Mill
66-557	1/2	2	1/2	4	14	Burr
66-558	1/2	2	1/2	4	14	End Mill



# 66-700 Series DFC Low-Helix Finisher Upcut

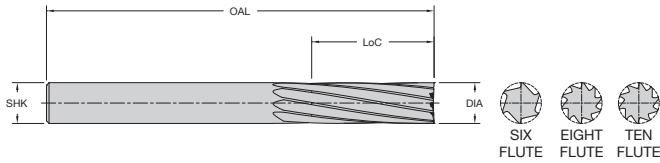

66-700 Series Low-Helix Finishers produce superior edge quality and finish in carbon fiber materials at high feed rates. LMT Onsrud's multi-flute design cuts quieter and faster than typical two or three-flute PCD tools in carbon fiber. The 66-700 Series tools are DFC coated.

### Features and Benefits

- Upcut helix design moves dust away from the cutting edge and prevents re-adhesion.
- Proprietary edge geometry delivers superior edge quality and finishes.
- Enhanced diamond film coating (DFC) for increased tool life.

66-700 Series-DFC Low-Helix Finisher- <b>Upcut</b> Product Offering					
Part Number	Cutting DIA (in)	LoC (in)	SHK DIA (in)	OAL (in)	Flutes
66-705	1/4	3/4	1/4	3-1/2	6
66-710	3/8	1-1/8	3/8	4	8
66-715	1/2	1-1/2	1/2	4	10

66-700 Series-DFC Low-Helix Finisher- <b>Upcut</b> Product Offering (Metric)					
Part Number	Cutting DIA (mm)	LoC (mm)	SHK DIA (mm)	OAL (mm)	Flutes
66-720	6	20	6	90	6
66-725	8	25	8	100	8
66-730	10	30	10	100	8
66-735	12	40	12	100	10

# 66-750 Series DFC Low-Helix Cutter

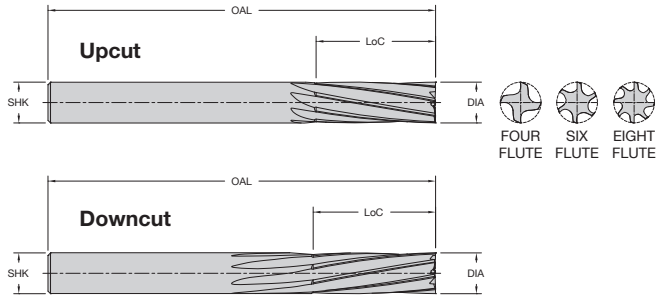

The 66-750 Series DFC Low-Helix Cutter is the low-helix cutter LMT Onsrud developed specifically for tight-tolerance applications with carbon fiber laminates. Achieve clean, precise cuts while reducing the risk of delamination.

### Features and Benefits

- Unique tool geometry allows for use in both heavy profiling and finishing operations.
- Low-Helix and optimized rake angles cleanly shear composite fibers to prevent delamination.
- Finisher with superior edge quality and ensures ideal wear characteristics.
- Enhanced diamond film coating (DFC) to protect cutting edges for increased tool life.

66-750 Series-DFC Low-Helix Cutter- <b>Upcut</b> Product Offering					
Part Number	Cutting DIA (in)	LoC (in)	SHK DIA (in)	OAL (in)	Flutes
66-751	1/4	1/2	1/4	3	4
66-753	1/4	3/4	1/4	3	4
66-755	3/8	3/4	3/8	3	6
66-757	3/8	1-1/8	3/8	3	6
66-759	1/2	1	1/2	3	8
66-761	1/2	1-1/2	1/2	4	8

66-750 Series-DFC Low-Helix Cutter- <b>Upcut</b> Product Offering (Metric)					
Part Number	Cutting DIA (mm)	LoC (mm)	SHK DIA (mm)	OAL (mm)	Flutes
66-766	6	20	6	90	4
66-768	8	25	8	100	6
66-770	10	30	10	100	6
66-772	12	38	12	100	8

66-750 Series-Solid Carbide DFC Low-Helix Cutter <b>Downcut</b> Product Offering					
Part Number	Cutting DIA (in)	LoC (in)	SHK DIA (in)	OAL (in)	Flutes
66-752	1/4	1/2	1/4	3	4
66-754	1/4	3/4	1/4	3	4
66-756	3/8	3/4	3/8	3	6
66-758	3/8	1-1/8	3/8	3	6
66-760	1/2	1	1/2	3-1/2	8
66-762	1/2	1-1/2	1/2	4	8

66-750 Series-Solid Carbide DFC Low-Helix Cutter <b>Downcut</b> Product Offering-Metric					
Part Number	Cutting DIA (mm)	LoC (mm)	SHK DIA (mm)	OAL (mm)	Flutes
66-767	6	20	6	90	4
66-769	8	25	8	100	6
66-771	10	30	10	100	6
66-773	12	38	12	100	8

## 66-775 Series DFC Low Helix Rougher Finisher - Upcut

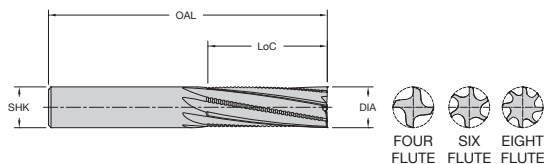

Tool is designed as a combination roughing and finishing tool in one. The roughing profile reduces cutting forces and the geometry of the finishing flutes cleanly shear fibers leaving a smooth edge on the workpiece material. Diamond coated (DFC) for increased tool life.

66-775 Series DFC Low Helix Rougher Finisher - **Upcut** Product Offering

Part Number	Cutting DIA (in)	LoC (in)	SHK DIA (in)	OAL (in)	Flutes
66-776	1/4	1/2	1/4	3	4
66-778	1/4	3/4	1/4	3	4
66-780	3/8	3/4	3/8	3	6
66-782	3/8	1-1/8	3/8	3	6
66-784	1/2	1	1/2	3	8
66-786	1/2	1-1/2	1/2	4	8

66-775 Series DFC Low Helix Rougher Finisher - **Upcut** Product Offering - Metric

Part Number	Cutting DIA (mm)	LoC (mm)	SHK DIA (mm)	OAL (mm)	Flutes
66-791	6	20	6	90	4
66-793	8	25	8	100	6
66-795	10	30	10	100	6
66-797	12	38	12	100	8

## 66-800 Series DFC Compression

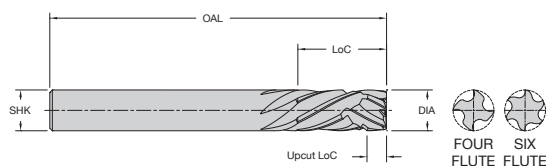
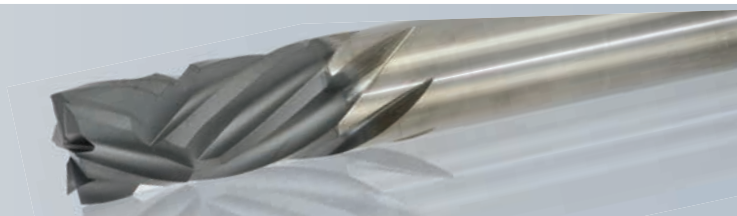

New redesigned compression router with optimized geometry to eliminate delamination and fiber pullout. Compression design allows for better surface workpiece finishes. Enhanced diamond coating (DFC) to protect cutting edges for increased tool life.

66-800 Series DFC Compression Product Offering

Part Number	Cutting DIA (in)	LoC (in)	Upcut LoC (in)	SHK DIA (in)	OAL (in)	Flutes
66-802	1/4	3/4	0.250	1/4	2-1/2	4
66-812	3/8	1	0.375	3/8	3	4
66-814	3/8	1	0.340	3/8	3	6
66-822	1/2	1	0.450	1/2	3	4
66-824	1/2	1	0.450	1/2	3	6
66-826	1/2	1-1/2	0.450	1/2	4	4
66-828	1/2	1-1/2	0.450	1/2	4	6

66-800 Series DFC Compression Product Offering - Metric

Part Number	Cutting DIA (mm)	LoC (mm)	Upcut LoC (mm)	SHK DIA (mm)	OAL (mm)	Flutes
66-852	6	20	7.75	6	90	4
66-858	8	25	8.00	8	100	4
66-864	10	25	8.50	10	100	6
66-870	12	25	9.00	12	100	6

# 66-900 Series High Performance Composite Router

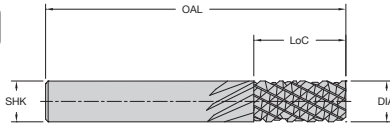
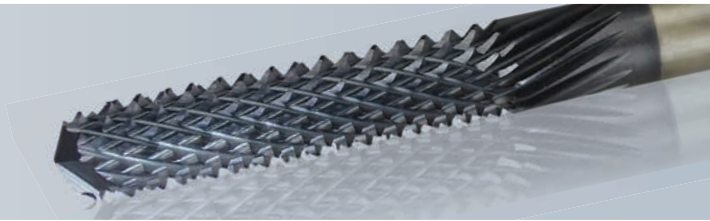

The High Performance Composite Router is designed for more efficient routing of composite materials, in both hand-fed and in CNC applications. Coated for increased tool life.

66-900 Series High Performance Composite Router Product Offering

Part Number	Point Style	Cutting DIA (in)	LoC (in)	SHK DIA (in)	OAL (in)
66-901ALTIN	No	1/8	1/2	1/8	1-1/2
66-902ALTIN	BURR	1/8	1/2	1/8	1-1/2
66-903ALTIN	Endmill	1/8	1/2	1/8	1-1/2
66-904ALTIN	Drill	1/8	1/2	1/8	1-1/2
66-905ALTIN	No	3/16	5/8	1/4	2
66-906ALTIN	BURR	3/16	5/8	1/4	2
66-907ALTIN	Endmill	3/16	5/8	1/4	2
66-908ALTIN	Drill	3/16	5/8	1/4	2
66-909ALTIN	No	1/4	1	1/4	3
66-910ALTIN	BURR	1/4	1	1/4	3
66-911ALTIN	Endmill	1/4	1	1/4	3
66-912ALTIN	Drill	1/4	1	1/4	3
66-913ALTIN	No	1/4	1-1/2	1/4	3-1/2
66-914ALTIN	BURR	1/4	1-1/2	1/4	3-1/2
66-915ALTIN	Endmill	1/4	1-1/2	1/4	3-1/2
66-916ALTIN	Drill	1/4	1-1/2	1/4	3-1/2
66-917ALTIN	No	1/4	2-1/8	1/4	4
66-918ALTIN	BURR	1/4	2-1/8	1/4	4
66-919ALTIN	Endmill	1/4	2-1/8	1/4	4
66-920ALTIN	Drill	1/4	2-1/8	1/4	4
66-921ALTIN	No	3/8	1	3/8	3
66-922ALTIN	BURR	3/8	1	3/8	3
66-923ALTIN	Endmill	3/8	1	3/8	3
66-924ALTIN	Drill	3/8	1	3/8	3
66-925ALTIN	No	3/8	1-5/8	3/8	3-1/2
66-926ALTIN	BURR	3/8	1-5/8	3/8	3-1/2
66-927ALTIN	Endmill	3/8	1-5/8	3/8	3-1/2
66-928ALTIN	Drill	3/8	1-5/8	3/8	3-1/2
66-929ALTIN	No	3/8	2-1/8	3/8	4
66-930ALTIN	BURR	3/8	2-1/8	3/8	4
66-931ALTIN	Endmill	3/8	2-1/8	3/8	4
66-932ALTIN	Drill	3/8	2-1/8	3/8	4
66-933ALTIN	No	1/2	1-1/8	1/2	3
66-934ALTIN	BURR	1/2	1-1/8	1/2	3
66-935ALTIN	Endmill	1/2	1-1/8	1/2	3
66-936ALTIN	Drill	1/2	1-1/8	1/2	3
66-937ALTIN	No	1/2	1-5/8	1/2	4
66-938ALTIN	BURR	1/2	1-5/8	1/2	4

66-900 Series High Performance Composite Router Product Offering

Part Number	Point Style	Cutting DIA (in)	LoC (in)	SHK DIA (in)	OAL (in)
66-939ALTIN	Endmill	1/2	1-5/8	1/2	4
66-940ALTIN	Drill	1/2	1-5/8	1/2	4
66-941ALTIN	No	1/2	2-1/8	1/2	4
66-942ALTIN	BURR	1/2	2-1/8	1/2	4
66-943ALTIN	Endmill	1/2	2-1/8	1/2	4
66-944ALTIN	Drill	1/2	2-1/8	1/2	4
66-945ALTIN	No	1/2	3-1/8	1/2	5
66-946ALTIN	BURR	1/2	3-1/8	1/2	5
66-947ALTIN	Endmill	1/2	3-1/8	1/2	5
66-948ALTIN	Drill	1/2	3-1/8	1/2	5
66-949ALTIN	No	1/2	4-1/8	1/2	6
66-950ALTIN	BURR	1/2	4-1/8	1/2	6
66-951ALTIN	Endmill	1/2	4-1/8	1/2	6
66-952ALTIN	Drill	1/2	4-1/8	1/2	6
66-971ALTIN	No	4mm	16mm	6mm	50mm
66-972ALTIN	BURR	4mm	16mm	6mm	50mm
66-973ALTIN	Endmill	4mm	16mm	6mm	50mm
66-974ALTIN	Drill	4mm	16mm	6mm	50mm
66-975ALTIN	No	6mm	19mm	6mm	75mm
66-976ALTIN	BURR	6mm	19mm	6mm	75mm
66-977ALTIN	Endmill	6mm	19mm	6mm	75mm
66-978ALTIN	Drill	6mm	19mm	6mm	75mm
66-979ALTIN	No	6mm	25mm	6mm	75mm
66-980ALTIN	BURR	6mm	25mm	6mm	75mm
66-981ALTIN	Endmill	6mm	25mm	6mm	75mm
66-982ALTIN	Drill	6mm	25mm	6mm	75mm
66-983ALTIN	No	8mm	25mm	8mm	63mm
66-984ALTIN	BURR	8mm	25mm	8mm	63mm
66-985ALTIN	Endmill	8mm	25mm	8mm	63mm
66-986ALTIN	Drill	8mm	25mm	8mm	63mm
66-987ALTIN	No	10mm	25mm	10mm	75mm
66-988ALTIN	BURR	10mm	25mm	10mm	75mm
66-989ALTIN	Endmill	10mm	25mm	10mm	75mm
66-990ALTIN	Drill	10mm	25mm	10mm	75mm
66-991ALTIN	No	12mm	25mm	12mm	75mm
66-992ALTIN	BURR	12mm	25mm	12mm	75mm
66-993ALTIN	Endmill	12mm	25mm	12mm	75mm
66-994ALTIN	Drill	12mm	25mm	12mm	75mm

# 67-000 Series Fiberglass Router

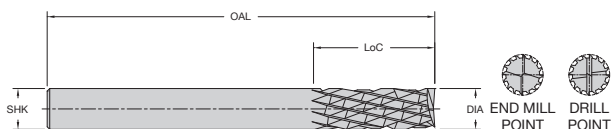
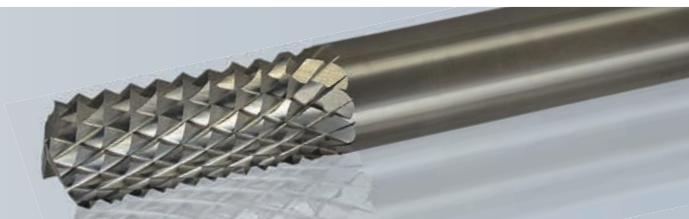

Designed as fiberglass routers. Their upcut/downcut diamond design effectively shears fibrous materials.

67-000 Series Solid Carbide Fiberglass Router Medium Burr W/End Mill Point Product Offering - Metric				
Part Number	Cutting DIA (mm)	LoC (mm)	SHK DIA (mm)	OAL (mm)
67-096	3	12	3	52
67-097	4	16	4	64
67-098	6	19	6	76
67-099	6	25	6	76
67-101	8	25	8	76
67-102	10	25	10	76
67-103	12	25	12	76

67-000 Series Solid Carbide Fiberglass Router Fine Burr W/Drill Point Product Offering				
Part Number	Cutting DIA (in)	LoC (in)	SHK DIA (in)	OAL (in)
67-080	1/4	3/4	1/4	2-1/2
67-120	3/8	7/8	3/8	2-1/2
67-160	1/2	1	1/2	3

67-000 Series Solid Carbide Fiberglass Router Medium Burr W/End Mill Point Product Offering				
Part Number	Cutting DIA (in)	LoC (in)	SHK DIA (in)	OAL (in)
67-003	1/8	1	1/8	2
67-010	1/4	3/4	1/4	2-1/2
67-011	1/4	1-1/8	1/4	3
67-012	1/4	1-1/4	1/4	3
67-014	1/4	1-1/2	1/4	3
67-017	1/4	2-1/8	1/4	4
67-030	3/8	7/8	3/8	2-1/2
67-023	3/8	1-5/8	3/8	3
67-027	3/8	2-1/8	3/8	4
67-031	1/2	1-1/8	1/2	3
67-033	1/2	1-5/8	1/2	4
67-037	1/2	2-1/8	1/2	4
67-039	1/2	3-1/8	1/2	5
67-065	3/4	4-1/8	3/4	6

67-000 Series Solid Carbide Fiberglass Router Fine Burr W/Drill Point Product Offering - Metric				
Part Number	Cutting DIA (mm)	LoC (mm)	SHK DIA (mm)	OAL (mm)
67-090	4	16	6	50
67-091	6	19	6	76
67-092	6	25	6	76
67-093	8	25	8	76
67-094	10	25	10	76
67-095	12	25	12	76

# 67-200 Series Phenolic Cutter Upcut & Downcut

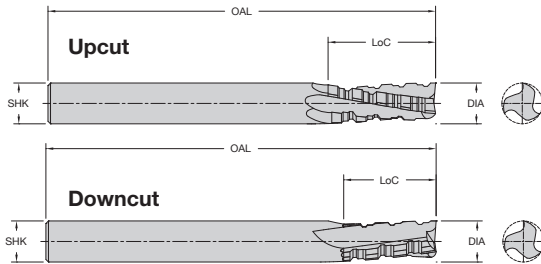

Phenolic materials, an organic resin based material, are used in various industrial applications due to their high strength, corrosion resistance, and insulation properties. Routing this material proves challenging due to its dense nature and high resin makeup, which reduces tool life.

LMT Onsrud's 67-200 Series solves this issue. The three flute, chipbreaker design allows for easy cutting, while providing better finishes and reduced noise levels. Diamond-Like-Carbon (DLC) coating option provides addition wear resistance and improved tool life for longer production runs.

### Features and Benefits

- Three flute geometry
- Chipbreaker design reduces lateral tool stress
- Diamond-Like-Carbon (DLC) coating offered
- Greater feed rates
- Smooth part finish
- Reduced noise level during operation

67-200 Series Solid Carbide Three Flute Phenolic Cutter <b>Upcut</b> Product Offering							
Part Number	Cutting DIA (in)	LoC (in)	SHK DIA (in)	OAL (in)	Neck Length (in)	Flutes	Coating
67-205	3/8	7/8	3/8	3	-	3	-
67-211	1/2	1-1/8	1/2	3	-	3	-
67-217	1/2	5/8	1/2	4	1-5/8	3	-
67-215	1/2	2-1/8	1/2	4	-	3	-
67-219	3/4	1-1/8	3/4	5	2-1/8	3	-
67-229	3/4	1-1/8	3/4	6	3-1/8	3	-
67-255	3/8	7/8	3/8	3	-	3	DLC
67-261	1/2	1-1/8	1/2	3-1/2	-	3	DLC
67-265	1/2	2-1/8	1/2	4-1/2	-	3	DLC
67-267	1/2	5/8	1/2	4	1-5/8	3	DLC
67-269	3/4	1-1/8	3/4	5	2-1/8	3	DLC
67-271	3/4	1-1/8	3/4	6	3-1/8	3	DLC

HELIX ANGLE ≈ 10°

67-200 Series Solid Carbide Three Flute Phenolic Cutter <b>Downcut</b> Product Offering							
Part Number	Cutting DIA (in)	LoC (in)	SHK DIA (in)	OAL (in)	Neck Length (in)	Flutes	Coating
67-206	3/8	7/8	3/8	3	-	3	-
67-212	1/2	1-1/8	1/2	3-1/2	-	3	-
67-218	1/2	5/8	1/2	4	1-5/8	3	-
67-216	1/2	2-1/8	1/2	4-1/2	-	3	-
67-220	3/4	1-1/8	3/4	5	2-1/8	3	-
67-231	3/4	1-1/8	3/4	6	3-1/8	3	-
67-260	3/8	7/8	3/8	3	-	3	DLC
67-262	1/2	1-1/8	1/2	3-1/2	-	3	DLC
67-266	1/2	2-1/8	1/2	4-1/2	-	3	DLC
67-268	1/2	5/8	1/2	4	1-5/8	3	DLC
67-270	3/4	1-1/8	3/4	5	2-1/8	3	DLC
67-272	3/4	1-1/8	3/4	6	3-1/8	3	DLC

67-200 Series Solid Carbide Three Flute Phenolic Cutter <b>Downcut</b> Product Offering - Metric							
Part Number	Cutting DIA (mm)	LoC (mm)	SHK DIA (mm)	OAL (mm)	Neck Length (in)	Flutes	Coating
67-208	10	22	10	75	-	3	-
67-210	12	28	12	75	-	3	-
67-274	10	22	10	75	-	3	DLC
67-276	12	28	12	75	-	3	DLC

67-200 Series Solid Carbide Three Flute Phenolic Cutter <b>Upcut</b> Product Offering - Metric							
Part Number	Cutting DIA (mm)	LoC (mm)	SHK DIA (mm)	OAL (mm)	Neck Length (in)	Flutes	Coating
67-207	10	22	10	75	-	3	-
67-209	12	28	12	75	-	3	-
67-273	10	22	10	75	-	3	DLC
67-275	12	28	12	75	-	3	DLC

## 67-220 Series PCD Progressive Chipbreaker

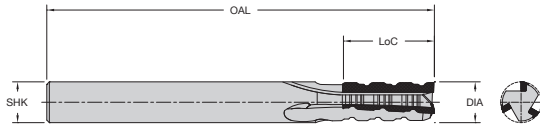
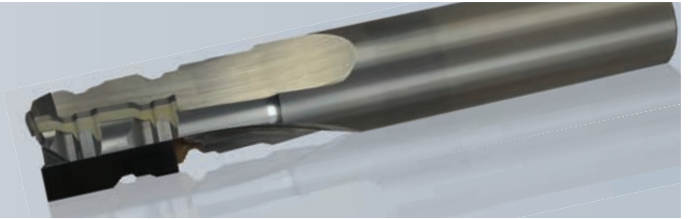

Provides superior chip control and increased tool life when cutting dense and abrasive materials. The new chipbreaker incorporates a unique geometry with a PCD cutting edge to support a wide range of feed rates and depth of cut combinations while extending the life of the tool. This is accomplished by utilizing a distinct Hi-Low asymmetrical chipbreaker profile which reduces vibration and chatter, caused by harmonic imbalance, resulting in improved surface finishes, while reducing noise levels and wear on the tool.

67-220 Series Three Flute - PCD Progressive Chipbreaker for Composites Product Offering

Part Number	Cutting DIA (in)	LoC (in)	SHK DIA (in)	OAL (in)	Flutes
67-221	3/8	3/8	3/8	3	3
67-225	1/2	5/8	1/2	3	3
67-227	1/2	1-1/8	1/2	3-1/2	3

67-220 Series Three Flute - PCD Progressive Chipbreaker for Composites Product Offering - Metric

Part Number	Cutting DIA (mm)	LoC (mm)	SHK DIA (mm)	OAL (mm)	Flutes
67-230	10	12	10	76	3
67-233	12	20	12	100	3

## 67-250 Series Downcut Diamond Grit Tool

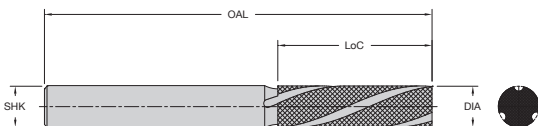
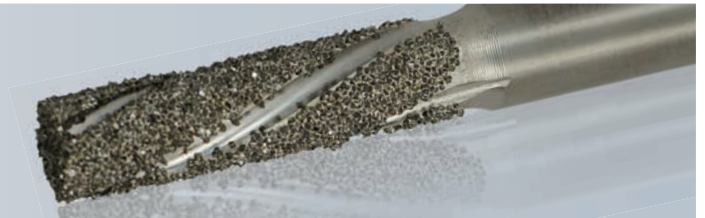

67-250 Series Three Flute **Downcut** Diamond Grit Tool Product Offering

Number	Cutting DIA (in)	LoC (in)	SHK DIA (in)	OAL (in)	Flutes
67-254	1/4	1-1/8	1/4	3	3
67-256	1/4	1-3/8	1/4	3	3
67-258	3/8	1-3/8	3/8	3	3

## 67-400 Series Un-Ruffer™ PATENTED

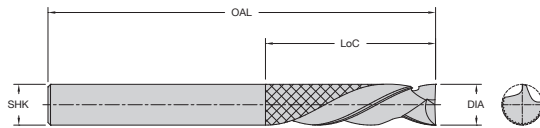
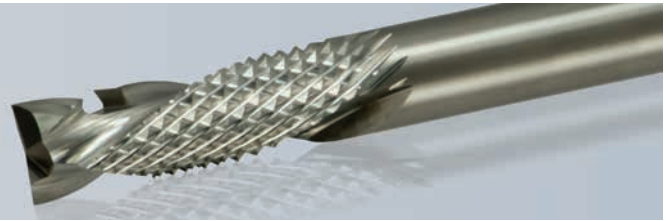

The unique design allows for the cutting performance of a burr while achieving a good surface finish.

67-400 Series Solid Carbide Un-Ruffer™ PATENTED Product Offering

Part Number	Cutting DIA (in)	LoC (in)	SHK DIA (in)	OAL (in)	Flutes
67-423	1/4	3/4	1/4	2	2
67-426	1/4	1	1/4	2-1/2	2
67-428	1/4	1	1/4	3	2
67-435	3/8	1	3/8	3	2
67-445	1/2	1	1/2	3	2

67-400 Series Solid Carbide Un-Ruffer™ PATENTED Product Offering - Metric

Part Number	Cutting DIA (mm)	LoC (mm)	SHK DIA (mm)	OAL (mm)	Flutes
67-426M	6	25	6	64	2
67-435M	10	25	10	76	2
67-445M	12	25	12	76	2

## 67-500 Series CG Tool

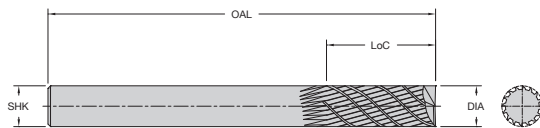
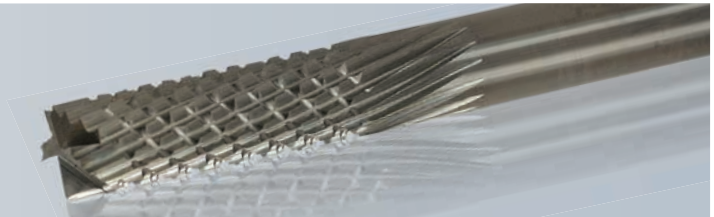

The geometry of these tools increases the amount of effective cutting flutes resulting in superior performance over a standard burr.

67-500 Series Solid Carbide CG Tool (Carbon Graphite) Product Offering

Part Number	Cutting DIA (in)	LoC (in)	SHK DIA (in)	OAL (in)
67-505	1/8	1/2	1/8	2
67-508	3/16	5/8	3/16	2
67-511	1/4	3/4	1/4	3
67-514	1/4	1-1/2	1/4	3
67-520	3/8	1-1/8	3/8	3-1/2
67-523	1/2	1-1/8	1/2	3-1/2
67-526	1/2	2-1/8	1/2	4

67-500 Series Solid Carbide CG Tool (Carbon Graphite) Product Offering - Metric

Part Number	Cutting DIA (mm)	LoC (mm)	SHK DIA (mm)	OAL (mm)
67-511M	6	20	6	76
67-520M	10	29	10	76
67-523M	12	29	12	88



# 67-800 Series 8 Facet Drill

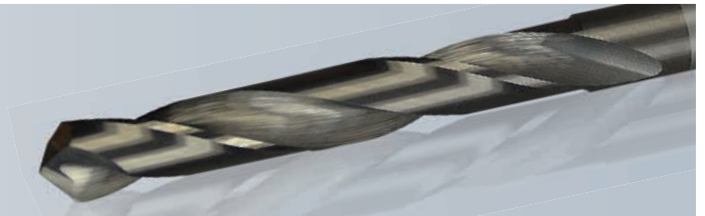

Designed to reduce cutting forces and eliminating delamination when exiting the material.

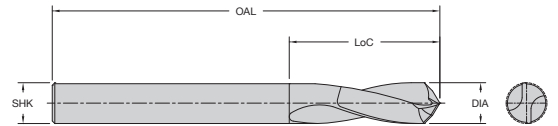

Fractional Drills						Letter Drills						Number Drills					
Part Number	Cutting DIA (in)	LoC (mm)	SHK DIA (mm)	OAL (mm)	Flutes	Part Number	Cutting DIA (in)	LoC (in)	SHK DIA (mm)	OAL (in)	Flutes	Part Number	Cutting DIA (in)	LoC (in)	SHK DIA (mm)	OAL (in)	Flutes
67-807	1/8 (0.1250)	1-1/4	0.125	2-1/4	2	67-850	A (0.2340)	2	0.234	3-1/4	2	67-876	1 (0.2280)	1-3/4	0.228	3	2
67-808	9/64 (0.1406)	1-3/8	0.140	2-1/2	2	67-851	B (0.2380)	2	0.238	3-1/4	2	67-877	2 (0.2210)	1-3/4	0.221	3	2
67-809	5/32 (0.1563)	1-3/8	0.156	2-1/2	2	67-852	C (0.2420)	2	0.242	3-1/4	2	67-878	3 (0.2130)	1-3/4	0.213	3	2
67-810	11/64 (0.1719)	1-5/8	0.172	2-3/4	2	67-853	D (0.2460)	2	0.246	3-1/4	2	67-879	4 (0.2090)	1-3/4	0.209	3	2
67-811	3/16 (0.1875)	1-5/8	0.188	2-3/4	2	67-854	E (0.2500)	2	0.250	3-1/4	2	67-880	5 (0.2055)	1-3/4	0.206	3	2
67-812	13/64 (0.2013)	1-3/4	0.203	3	2	67-855	F (0.2570)	2	0.257	3-1/4	2	67-881	6 (0.2040)	1-3/4	0.204	3	2
67-813	7/32 (0.2188)	1-3/4	0.219	3	2	67-856	G (0.2610)	2-1/8	0.261	3-1/2	2	67-882	7 (0.2010)	1-3/4	0.201	3	2
67-814	15/64 (0.2344)	2	0.234	3-1/4	2	67-857	H (0.2660)	2-1/8	0.266	3-1/2	2	67-883	8 (0.1990)	1-3/4	0.199	3	2
67-815	1/4 (0.2500)	2	0.250	3-1/4	2	67-858	I (0.2720)	2-1/8	0.272	3-1/2	2	67-884	9 (0.1960)	1-3/4	0.196	3	2
67-816	17/64 (0.2656)	2-1/8	0.266	3-1/2	2	67-859	J (0.2770)	2-1/8	0.277	3-1/2	2	67-885	10 (0.1935)	1-5/8	0.194	2-3/4	2
67-817	9/32 (0.2813)	2-1/8	0.281	3-1/2	2	67-860	K (0.2810)	2-1/8	0.281	3-1/2	2	67-886	11 (0.1910)	1-5/8	0.191	2-3/4	2
67-818	19/64 (0.2969)	2-3/8	0.297	3-3/4	2	67-861	L (0.2900)	2-1/8	0.290	3-1/2	2	67-887	12 (0.1890)	1-5/8	0.189	2-3/4	2
67-819	5/16 (0.3125)	2-3/8	0.313	3-3/4	2	67-862	M (0.2950)	2-3/8	0.295	3-3/4	2	67-888	13 (0.1850)	1-5/8	0.185	2-3/4	2
67-820	21/64 (0.3281)	2-1/2	0.328	4	2	67-863	N (0.3020)	2-3/8	0.302	3-3/4	2	67-889	14 (0.1820)	1-5/8	0.182	2-3/4	2
67-821	11/32 (0.3438)	2-1/2	0.344	4	2	67-864	O (0.3160)	2-3/8	0.316	3-3/4	2	67-890	15 (0.1800)	1-5/8	0.180	2-3/4	2
67-822	23/64 (0.3594)	2-1/2	0.359	4	2	67-865	P (0.3230)	2-3/8	0.323	3-3/4	2	67-891	16 (0.1770)	1-5/8	0.177	2-3/4	2
67-823	3/8 (0.3750)	2-3/4	0.375	4-1/4	2	67-866	Q (0.3320)	2-1/2	0.332	4	2	67-892	17 (0.1730)	1-5/8	0.173	2-3/4	2
67-824	25/64 (0.3906)	2-7/8	0.391	4-1/2	2	67-867	R (0.3390)	2-1/2	0.339	4	2	67-893	18 (0.1695)	1-5/8	0.170	2-3/4	2
67-825	13/32 (0.4063)	2-7/8	0.406	4-1/2	2	67-868	S (0.3480)	2-1/2	0.348	4	2	67-894	19 (0.1660)	1-5/8	0.166	2-3/4	2
67-826	27/64 (0.4219)	2-7/8	0.422	4-1/2	2	67-869	T (0.3580)	2-1/2	0.358	4	2	67-895	20 (0.1610)	1-3/8	0.161	2-1/2	2
67-827	7/16 (0.4375)	2-7/8	0.438	4-1/2	2	67-870	U (0.3680)	2-3/4	0.368	4-1/4	2	67-896	21 (0.1590)	1-3/8	0.159	2-1/2	2
67-828	29/64 (0.4531)	3	0.453	4-3/4	2	67-871	V (0.3770)	2-3/4	0.377	4-1/4	2	67-897	22 (0.1570)	1-3/8	0.157	2-1/2	2
67-829	15/32 (0.4688)	3	0.469	4-3/4	2	67-872	W (0.3860)	2-7/8	0.386	4-1/2	2	67-898	23 (0.1540)	1-3/8	0.154	2-1/2	2
67-830	31/64 (0.4844)	3	0.484	4-3/4	2	67-873	X (0.3970)	2-7/8	0.397	4-1/2	2	67-899	24 (0.1520)	1-3/8	0.152	2-1/2	2
67-831	1/2 (0.5000)	3	0.500	4-3/4	2	67-874	Y (0.4040)	2-7/8	0.404	4-1/2	2	67-900	25 (0.1495)	1-3/8	0.150	2-1/2	2
						67-875	Z (0.4130)	2-7/8	0.413	4-1/2	2	67-901	26 (0.1470)	1-3/8	0.147	2-1/2	2
												67-902	27 (0.1440)	1-3/8	0.144	2-1/2	2
												67-903	28 (0.1405)	1-3/8	0.141	2-1/2	2
												67-904	29 (0.1360)	1-3/8	0.136	2-1/2	2
												67-905	30 (0.1285)	1-1/4	0.129	2-1/4	2
												67-906	31 (0.1200)	1-1/4	0.120	2-1/4	2

# 67-800 Series 8 Facet Drill (Cont.)

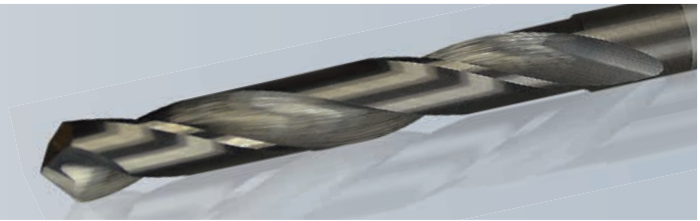

Designed to reduce cutting forces and eliminating delamination when exiting the material.

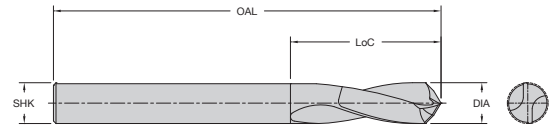

Metric Drills					
Part Number	Cutting DIA (mm)	LoC (mm)	SHK DIA (mm)	OAL (mm)	Flutes
67-961	3.00 (0.1181)	32	3.00	57	2
67-962	3.50 (0.1378)	35	3.50	64	2
67-963	4.00 (0.1575)	35	4.00	64	2
67-964	4.50 (0.1772)	41	4.50	70	2
67-965	5.00 (0.1969)	44	5.00	76	2
67-966	5.50 (0.2165)	44	5.50	76	2
67-967	6.00 (0.2362)	51	6.00	83	2
67-968	6.50 (0.2559)	51	6.50	83	2
67-969	7.00 (0.2756)	57	7.00	89	2
67-970	7.50 (0.2953)	60	7.50	95	2
67-971	8.00 (0.3150)	60	8.00	95	2
67-972	8.50 (0.3346)	64	8.50	102	2
67-973	9.00 (0.3543)	64	9.00	102	2
67-974	9.50 (0.3740)	70	9.50	108	2
67-975	10.00 (0.3937)	73	10.00	114	2
67-976	10.50 (0.4134)	73	10.50	114	2
67-977	11.00 (0.4331)	73	11.00	114	2
67-978	11.50 (0.4528)	76	11.50	121	2
67-979	12.00 (0.4724)	76	12.00	121	2

### What is an 8 Facet Drill?

An 8 facet drill consists of 4 cutting edges with 2 facets per cutting edge. These facets consist of the lip relief and the lip clearance angle.

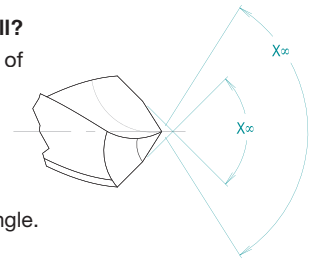

## 68-000 Series PCD Tipped

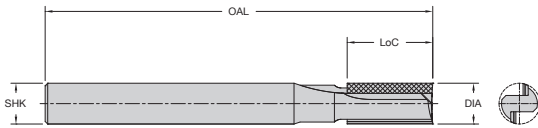
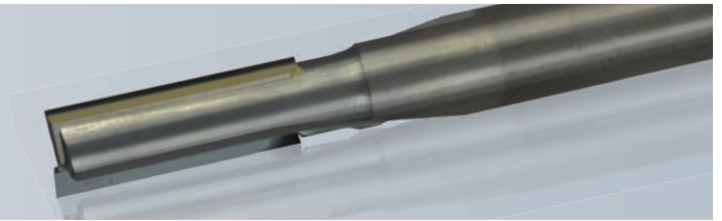

Designed for use in abrasive materials where cut quality and tool life are important.

68-000 Series Two Flute - PCD Tipped Tooling PCD Full Face Product Offering

Part Number	Cutting DIA (in)	LoC (in)	SHK DIA (in)	OAL (in)	Flutes
68-005	1/4	3/4	1/4	3	2
68-010	3/8	3/4	3/8	3	2
68-020	1/2	3/4	1/2	4	2
68-030	3/4	1	3/4	4	2

HELIX ANGLE  $\approx 0 - 3^\circ$

68-000 Series Two Flute - PCD Tipped Tooling PCD Full Face With Plunge Point Product Offering

Part Number	Cutting DIA (in)	LoC (in)	SHK DIA (in)	OAL (in)	Flutes
68-050	1/4	3/4	1/4	3	2
68-055	3/8	7/8	3/8	3	2
68-062	1/2	1-1/4	1/2	4	2
68-070	3/4	1-1/4	3/4	4	2
68-072	3/4 Down Shear	1-1/4	3/4	4	2

## 68-100 Series PCD Compression

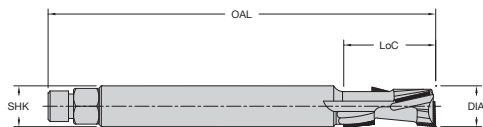

This economical PCD compression tool will provide long tool life in abrasive wood products. Mortise tip allowing for through cuts and dado's to be produced using one tool. The compression design ensures chip free edges on the top and bottom.

68-100 Series Single Flute - PCD Compression Tool Product Offering

Part Number	Cutting DIA (in)	LoC (in)	Upcut LoC (in)	SHK DIA (in)	OAL (in)	Flutes
68-101	3/8	1	0.188	3/8	3	1
68-101L	3/8	1	0.188	3/8	3	1
68-100	3/8	1	0.188	1/2	3	1
68-100L	3/8	1	0.188	1/2	3	1
68-102	1/2	1	0.200	1/2	3	1
68-102L	1/2	1	0.200	1/2	3	1
68-103	1/2	1-1/4	0.200	1/2	3	1
68-104	5/8	1	0.200	5/8	3-1/2	1
68-104L	5/8	1	0.200	5/8	3-1/2	1
68-110	5/8	1-5/8	0.200	5/8	4	1
68-110L	5/8	1-5/8	0.200	5/8	4	1
68-106	3/4	1	0.200	3/4	4	1
68-106L	3/4	1	0.200	3/4	4	1
68-112	3/4	1-5/8	0.200	3/4	4	1
68-112L	3/4	1-5/8	0.200	3/4	4	1

L = Left Hand Rotation

## 68-200 Series PCD SERF™ Cutter

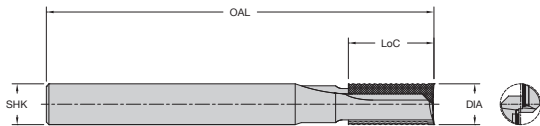
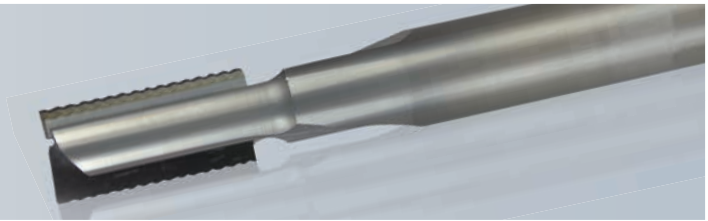

This tool is designed to act like a rougher and finishing tool in one. The unique geometry reduces the cutting forces resulting in longer tool life, higher feed rates and reduced noise.

68-200 Series Two Flute - PCD SERF™ Cutter Product Offering - Metric

Part Number	Cutting DIA (mm)	LoC (mm)	SHK DIA (mm)	OAL (mm)	Flutes
68-213M	6	20	6	76	2
68-226M	10	25	10	88	2
68-236M	12	32	12	100	2

68-200 Series Two Flute - PCD SERF™ Cutter Product Offering

Part Number	Cutting DIA (in)	LoC (in)	SHK DIA (in)	OAL (in)	Flutes
68-210	1/4	3/8	1/4	3	2
68-213	1/4	3/4	1/4	3	2
68-216	1/4	1	1/4	3-1/2	2
68-220	3/8	3/8	3/8	3	2
68-223	3/8	3/4	3/8	3	2
68-226	3/8	1	3/8	3-1/2	2
68-230	1/2	3/4	1/2	4	2
68-233	1/2	1	1/2	4	2
68-236	1/2	1-1/4	1/2	4	2

## 68-300 Series PCD SERFIN™ Cutter

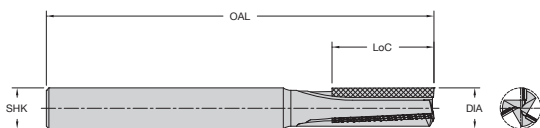
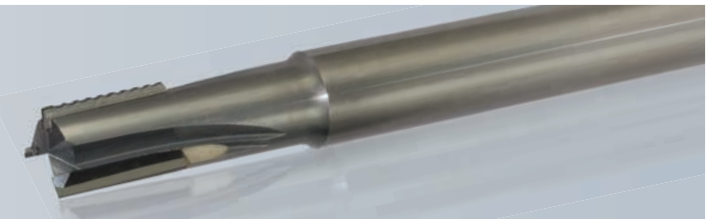

Three-Flute tool with two roughing edges that have geometry to reduce cutting forces and shear fibers in high-strength composite and other fiber reinforced plastic materials. The finishing edge cleans up after roughing cuts to create a smooth edge on material.

68-300 Series Three Flute - PCD SERFIN™ Cutter Product Offering

Part Number	Cutting DIA (in)	LoC (in)	SHK DIA (in)	OAL (in)	Flutes
68-315	3/8	1/2	3/8	4	3
68-320	3/8	7/8	3/8	4	3
68-340	1/2	5/8	1/2	4	3
68-345	1/2	1	1/2	4	3
68-350	1/2	1-1/4	1/2	4	3
68-360	3/4	1-3/8	3/4	5	3

68-300 Series Three Flute - PCD SERFIN™ Cutter Product Offering - Metric

Part Number	Cutting DIA (mm)	LoC (mm)	SHK DIA (mm)	OAL (mm)	Flutes
68-310	8	10	8	76	3
68-325	10	14	10	100	3
68-330	12	14	12	100	3
68-335	12	26	12	100	3
68-355	16	26	16	100	3

## 68-400 Series PCD Ballnose

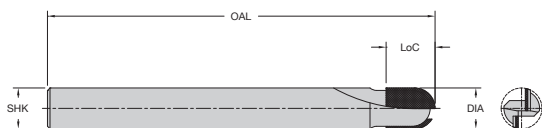
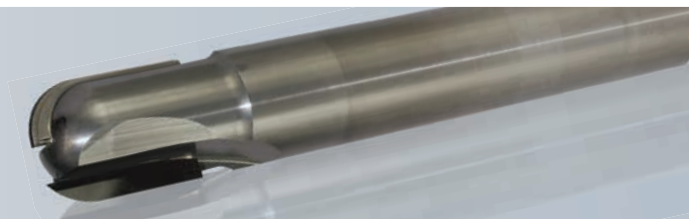

Designed for use in abrasive materials where cut quality and tool life are important.

68-400 Series Two Flute - PCD Ballnose Product Offering					
Part Number	Cutting DIA (in)	LoC (in)	SHK DIA (in)	OAL (in)	Flutes
68-405	1/4	3/8	1/4	2-1/2	2
68-410	3/8	1/2	3/8	3	2
68-420	1/2	5/8	1/2	4	2
68-425	5/8	7/8	5/8	4	2
68-430	3/4	1	3/4	4	2

68-400 Series Two Flute - PCD Ballnose Product Offering - Metric					
Part Number	Cutting DIA (mm)	LoC (mm)	SHK DIA (mm)	OAL (mm)	Flutes
68-440	6	10	6	76	2
68-445	8	10	8	76	2
68-450	10	12	10	76	2
68-455	12	20	12	100	2

## 68-500 Series PCD Engravers

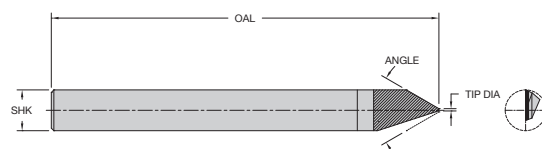
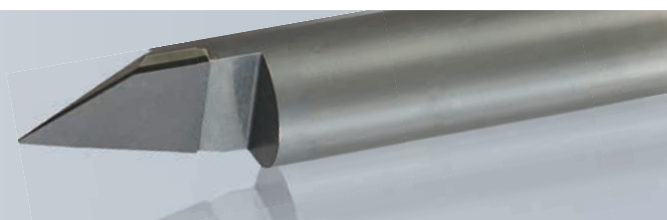

LMT Onsrud designed 68-500 Series PCD Engravers with tool life in mind. The ultra-high performance PolyCrystalline Diamond (PCD) provides extreme performance and best-in-class tool life. Safely run at feed rates up to 30% faster than carbide and achieve better finishes and faster results with the flexibility of a wide range of tips for any type of engraving.

### Features and Benefits

- PCD engraving bits can be recommended for use in all materials except soft plastics and ferrous metals.
- PCD engraving bits increase tool life over carbide engraving bits for CFRP and other materials.
- Feed rates when using LMT Onsrud PCD Engravers in aluminum can be increased up to 30%.

68-500 Series PCD Engravers Product Offering				
Part Number	Tip DIA (in)	Included Angle	SHK DIA (in)	OAL (in)
68-502	0.010	60°	1/4	2-1/4
68-504	0.020	60°	1/4	2-1/4
68-506	0.030	60°	1/4	2-1/4

# 68-900 Series PCD 8 Facet Drills

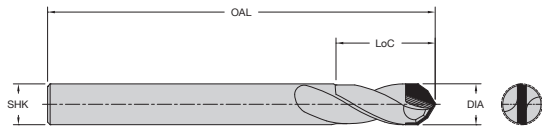
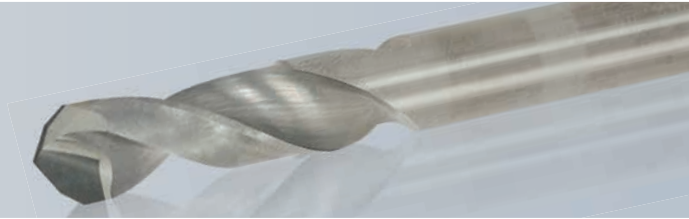

The PCD 8 facet drill works well in composite material where long tool life and a delamination free hole is required. The drill diameters are oversized allowing for aircraft fasteners to extend through the holes.

### What is an 8 Facet Drill?

An 8 facet drill consists of 4 cutting edges with 2 facets per cutting edge. These facets consist of the lip relief and the lip clearance angle.

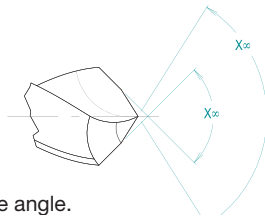

68-900 Series Two Flute PCD 8 Facet Drills Product Offering					
Part Number	Cutting DIA (in)	LoC (in)	SHK DIA (in)	OAL (in)	Flutes
68-902	0.100	1	1/4	3	2
68-904	0.129	1	1/4	3	2
68-908	0.147	1	1/4	3	2
68-910	0.192	1	1/4	3	2
68-914	0.251	1	1/4	3	2
68-918	0.313	1	5/16	3	2
68-922	0.376	1	3/8	3	2
68-926	0.502	1	1/2	3	2

# 70-100 Series Trim Blade and Arbor

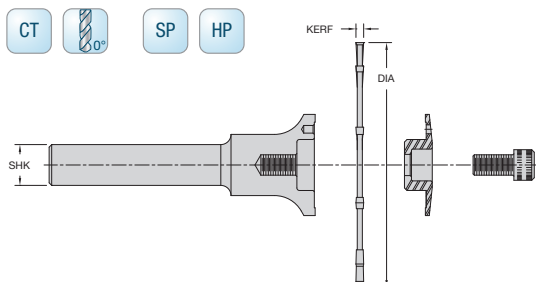
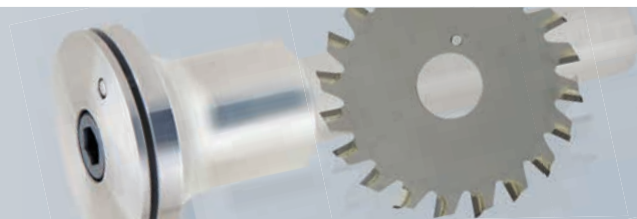

Designed to trim and groove both hard and soft plastics.  
These blades run in conjunction with the blade arbors.  
Blades are reversible for right or left hand rotation cutting.

70-100 Series Carbide Tipped Trim Blade Soft Plastic - Slow Feed Product Offering					
Part Number	Cutting DIA (in)	Teeth	Rake	Kerf	Grind
70-100	2	10	0°	.095	TCG
70-102	2-1/2	10	0°	.095	TCG
70-104	3	10	0°	.095	TCG
70-108	4	10	0°	.095	TCG

70-100 Series Carbide Tipped Trim Blade Soft Plastic - Fast Feed Product Offering					
Part Number	Cutting DIA (in)	Teeth	Rake	Kerf	Grind
70-120	2	16	0°	.095	TCG
70-122	2-1/2	20	0°	.095	TCG
70-124	3	20	0°	.095	TCG
70-126	3-1/2	20	0°	.095	TCG
70-128	4	20	0°	.095	TCG

70-100 Series Carbide Tipped Trim Blade Hard Plastic - Fast Feed Product Offering					
Part Number	Cutting DIA (in)	Teeth	Rake	Kerf	Grind
70-160	2	16	-5°	.095	TCG
70-162	2-1/2	20	-5°	.095	TCG
70-164	3	20	-5°	.095	TCG
70-166	3-1/2	20	-5°	.095	TCG
70-168	4	20	-5°	.095	TCG

TCG = Triple Chip Grind

70-100 Series Carbide Tipped Trim Blade And Arbor - Saw Arbor Product Offering		
Part Number	Cutting DIA (in)	OAL (in)
70-180	1/2	3-1/4
70-181	1/2	4-1/2

These saw arbors are designed to hold the carbide tipped saws.

\*SEE FEED & SPEED CHART ON PAGE 88

# 70-200 Series Trim Blade Flush Mount

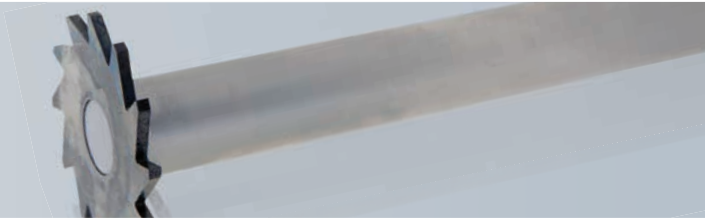

SC SP HP

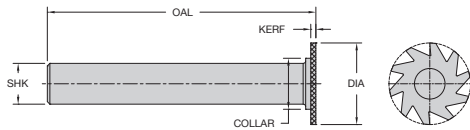

70-200 Series Solid Carbide Trim Blade Flush Mount Product Offering						
Part Number	Cutting DIA (in)	Collar (in)	SHK DIA (in)	Kerf (in)	OAL (in)	Rotation
70-204	1	9/16	1/2	.062	4	Right
70-224	1-1/4	5/8	1/2	.062	4	Right

\*SEE FEED & SPEED CHART BELOW

These small diameter solid carbide arbor mounted blades are designed for trimming and slotting plastics. Blades are permanently attached to arbors and are not reversible.

# 70-300 Series Trim Blade Flush Mount

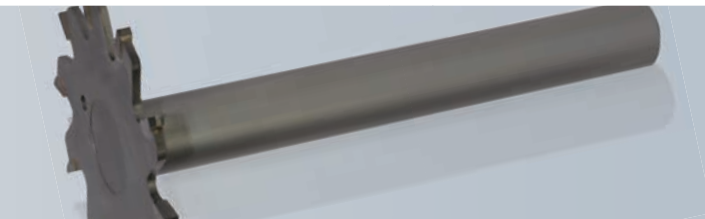

CT SP HP

Designed for flush trimming and slotting of both hard and soft plastics. Blades are permanently attached to arbors and are not reversible.

70-300 Series Solid Carbide Trim Blade Flush Mount Product Offering										
Part Number	Cutting DIA (in)	Teeth	Rake	SHK DIA (in)	KERF (in)	OAL (in)	Grind	Rotation	Plastic	Feed
70-300	2	10	0°	1/2	.095	4	TCG	RH	Soft	Slow
70-302	2	10	0°	1/2	.095	4	TCG	LH	Soft	Slow
70-320	2	16	0°	1/2	.095	4	TCG	RH	Soft	Fast
70-322	2	16	0°	1/2	.095	4	TCG	LH	Soft	Fast
70-340	2	10	-5°	1/2	.095	4	TCG	RH	Hard	Slow
70-342	2	10	-5°	1/2	.095	4	TCG	LH	Hard	Slow
70-360	2	16	-5°	1/2	.095	4	TCG	RH	Hard	Fast
70-362	2	16	-5°	1/2	.095	4	TCG	LH	Hard	Fast

\*SEE FEED & SPEED CHART BELOW  
TCG = Triple Chip Grind

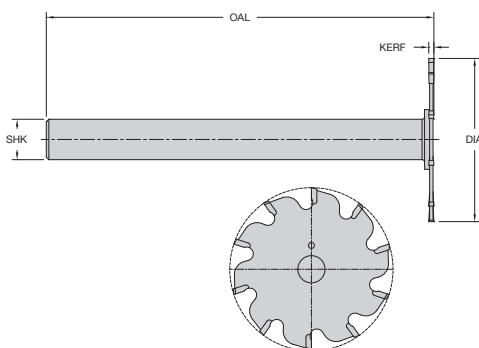

Feeds & Speeds for Blades (Inches Per Minute)					
Tool Series	Cutting DIA (in)	Max RPM	Soft Plastic	Hard Plastic	Fibrous Reinfrc
70-100	2"	18,000	150	150	150
70-100	2-1/2"	16,000	150	150	150
70-100	3"	14,000	150	150	150
70-100	3-1/2"	12,000	150	150	150
70-100	4"	10,000	150	150	150
70-200	1-1/2" & Smaller	14,000	150	150	150
70-300	2"	16,000	150	150	150



# 70-500 Series HSS Plastic Drill



Designed to produce holes in hard and soft plastic while eliminating edge chipping and chip wrapping.



- NO Wrapping
- NO Cleaning
- NO Melting
- NO Surface Marring
- NO Interrupted Operation

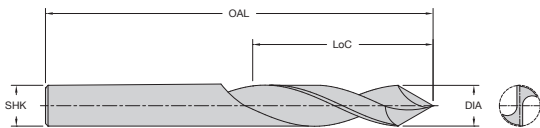

Fractional Drills					
Part Number	Cutting DIA (in)	LoC (in)	SHK DIA (in)	OAL (in)	Flutes
70-502	1/8 (0.125)	1-1/2	1/8	2-3/4	2
70-503	9/64 (0.141)	1-3/4	9/64	2-7/8	2
70-506	5/32 (0.156)	1-15/16	5/32	3-1/8	2
70-509	11/64 (0.172)	1-3/4	11/64	3-1/4	2
70-510	3/16 (0.188)	2-1/8	3/16	3-1/2	2
70-511	13/64 (0.203)	2-7/16	13/64	3-5/8	2
70-512	7/32 (0.219)	2-1/2	7/32	3-3/4	2
70-513	15/64 (0.234)	2-5/8	15/64	3-7/8	2
70-514	1/4 (0.250)	2-7/16	1/4	4	2
70-515	17/64 (0.266)	2-7/8	17/64	4-1/8	2
70-516	9/32 (0.281)	2-15/16	9/32	4-1/4	2
70-517	19/64 (0.297)	3-1/16	19/64	4-3/8	2
70-520	5/16 (0.313)	1-3/4	1/4	3-1/8	2

Fractional Drills					
Part Number	Cutting DIA (in)	LoC (in)	SHK DIA (in)	OAL (in)	Flutes
70-521	21/64 (0.328)	3-5/16	21/64	4-5/8	2
70-522	11/32 (0.344)	3-7/16	11/32	4-3/4	2
70-523	23/64 (0.359)	3-1/2	23/64	4-7/8	2
70-524	3/8 (0.375)	2-1/4	1/4	4-3/8	2
70-525	25/64 (0.391)	3-3/4	25/64	5-1/8	2
70-526	13/32 (0.406)	3-7/8	13/32	5-1/8	2
70-527	27/64 (0.422)	3-15/16	27/64	5-3/8	2
70-528	7/16 (0.438)	2-1/2	1/4	4-3/4	2
70-529	29/64 (0.453)	4-3/16	29/64	5-5/8	2
70-530	15/32 (0.469)	4-5/16	15/32	5-3/4	2
70-531	31/64 (0.484)	4-3/8	31/64	5-7/8	2
70-532	1/2 (0.500)	2-5/8	1/4	5-1/8	2

Metric Drills					
Part Number	Cutting DIA (mm)	LoC (mm)	SHK DIA (mm)	OAL (mm)	Flutes
70-714	3.00 (0.118)	41	3.00	70	2
70-716	4.00 (0.157)	54	4.00	83	2
70-718	5.00 (0.197)	62	5.00	92	2
70-720	6.00 (0.236)	70	6.00	102	2
70-722	7.00 (0.276)	73	7.00	105	2
70-724	8.00 (0.315)	81	8.00	114	2
70-726	9.00 (0.354)	89	9.00	124	2
70-728	10.00 (0.394)	95	10.00	130	2

# 72-000 Series Boring Bits

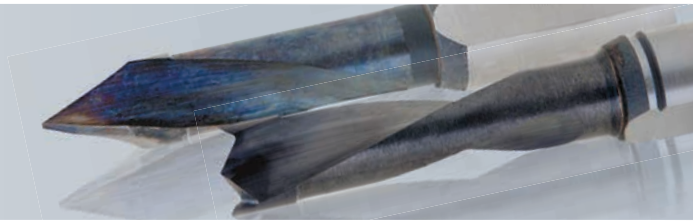

Two style of tools are available in this series. The brad point drill is designed to cut blind holes and produce a clean edge on the top surface. The 60° through drill is designed to produce through holes while providing clean edges on both sides.

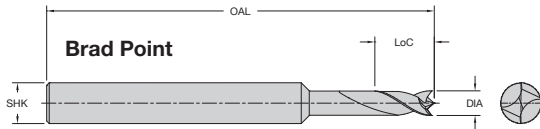

**Brad Point** - Designed to produce a blind hole while preventing fraying on the top edge.

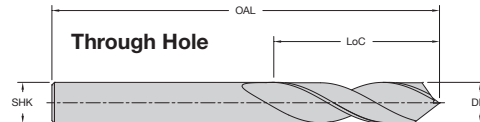

**Through Hole (60° Point)** - Produces a through hole and reduces fraying on the entry and exit edges.

72-000 Series Solid Carbide Boring Bits - Right Hand Rotation Product Offering									
Part Number	Cutting DIA (in)	SHK DIA (in)	OAL (in)	Flutes	Part Number	Cutting DIA (in)	SHK DIA (in)	OAL (in)	Flutes
72-001	3	10	57	2	72-021	3	10	70	2
72-005	5	10	57	2	72-025	5	10	70	2
72-009	6	10	57	2	72-029	6	10	70	2
72-013	8	10	57	2	72-033	8	10	70	2

72-000 Series Solid Carbide Boring Bits - Right Hand Rotation Product Offering									
Part Number	Cutting DIA (in)	SHK DIA (in)	OAL (in)	Flutes	Part Number	Cutting DIA (in)	SHK DIA (in)	OAL (in)	Flutes
72-053	3	10	57	2	72-075	3	10	70	2
72-057	5	10	57	2	72-079	5	10	70	2
72-061	6	10	57	2	72-083	6	10	70	2
72-065	8	10	57	2	72-087	8	10	70	2

72-000 Series Solid Carbide Boring Bits - Left Hand Rotation Product Offering									
Part Number	Cutting DIA (in)	SHK DIA (in)	OAL (in)	Flutes	Part Number	Cutting DIA (in)	SHK DIA (in)	OAL (in)	Flutes
72-002	3	10	57	2	72-022	3	10	70	2
72-006	5	10	57	2	72-026	5	10	70	2
72-010	6	10	57	2	72-030	6	10	70	2
72-014	8	10	57	2	72-034	8	10	70	2

72-000 Series Solid Carbide Boring Bits - Left Hand Rotation Product Offering									
Part Number	Cutting DIA (in)	SHK DIA (in)	OAL (in)	Flutes	Part Number	Cutting DIA (in)	SHK DIA (in)	OAL (in)	Flutes
72-054	3	10	57	2	72-076	3	10	70	2
72-058	5	10	57	2	72-080	5	10	70	2
72-062	6	10	57	2	72-084	6	10	70	2
72-066	8	10	57	2	72-088	8	10	70	2

**Hinge Bit** - This 35mm carbide tipped bit is designed to produce a flat bottom hole with clean edges for hinge mounting.

72-000 Series Solid Carbide Boring Bits Product Offering				
Part Number	Cutting DIA (in)	SHK DIA (in)	OAL (in)	Flutes
72-097	35	10	70	2

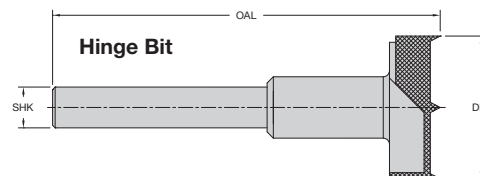

# 77-100 Series Taper Tools

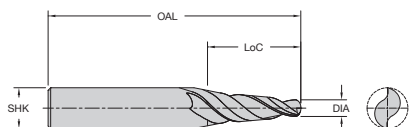
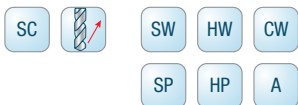

The taper tools are available with a variety of taper angles and come standard with a ball nose point. The tools are designed to produce a good edge finish in a wide variety of materials.

77-100 Series Two or Three Flute Solid Carbide Taper Tools Product Offering							
Part Number	Cutting DIA (in)	LoC (in)	SHK DIA (in)	OAL (in)	Angle Per Side	Radius (in)	Flutes
77-102	1/8	1-1/2	1/4	3	1°	1/16	3
77-104	1/8	1	1/4	3	3°	1/16	3
77-106	1/8	3/4	1/4	3	5°	1/16	3
77-108	1/8	1/2	1/4	3	7°	1/16	3
77-112	1/4	2	1/2	4	3°	1/8	2
77-114	1/4	1-3/8	1/2	4	5°	1/8	2
77-116	1/4	1	1/2	4	7°	1/8	2

77-100 Series Two or Three Flute Solid Carbide Taper Tools Product Offering - Metric							
Part Number	Cutting DIA (mm)	LoC (mm)	SHK DIA (mm)	OAL (mm)	Angle (mm)	Radius (mm)	Flutes
77-102M	3mm	39mm	6mm	76mm	1°	1.5mm	3
77-104M	3mm	25mm	6mm	76mm	3°	1.5mm	3
77-106M	3mm	19mm	6mm	76mm	5°	1.5mm	3
77-108M	3mm	12mm	6mm	76mm	7°	1.5mm	3
77-112M	6mm	50mm	12mm	100mm	3°	3mm	2
77-114M	6mm	35mm	12mm	100mm	5°	3mm	2
77-116M	6mm	25mm	12mm	100mm	7°	3mm	2

## 80-000 Series Taper Pin Router



HSS  A

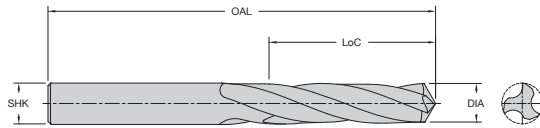

These three flute upcuts with a tapered flute are used for profiling and trimming primarily in aircraft assembly operations.

80-000 Series Three Flute - High Speed Steel Taper Pin Router Product Offering					
Part Number	Cutting DIA (in)	LoC (in)	SHK DIA (in)	OAL (in)	Flutes
80-001	.098	3/4	.098	2	3
80-002	.110	7/8	.128	2-1/4	3
80-003	.165	1-1/16	.1875	2-1/2	3

HELIX ANGLE ≈ 24°

## 81-000 Series Lo Helix



HSS  A

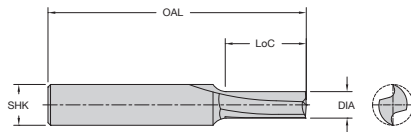

These lo helix upcut spirals were developed for CNC routers used primarily in the aircraft industry. They are designed with maximum strength of configuration to cut T, O or combined stacks of aluminum-using coolant.

81-000 Series Two Flute - High Speed Steel Lo Helix Product Offering							
Part Number	Cutting DIA (in)	LoC (in)	SHK DIA (in)	OAL (in)	Helix	ALUM Condition	Flutes
81-001	1/4	3/4	1/2	3-1/16	5°	T	2
81-003	5/16	3/4	1/2	3-1/16	10°	C	2

# 81-100 Series Spiral Extrusion Cutters

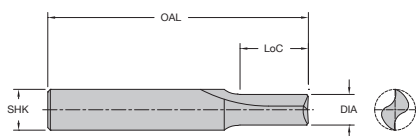

Designed for reduced vibration producing smoother finish cuts. Extended reach during side thinning and gage reduction. Longer tool life to reduce tool changes.

81-100 Series Two Flute - Solid Carbide Spiral Extrusion Cutters Product Offering										
Part Number	Cutting DIA (in)	LoC (in)	ERL	SHK DIA (in)	OAL (in)	Helix & DIR	CNR RAD Chamfer	Aluminum Condition	Machining Environment	Flutes
Tolerance	+ .002	±.03	-	+ .0000 - .0005	±.03	-	-	-	-	-
81-103	5/16	13/16	-	1/2	3	10°RH	.02 x 45°	C	Wet	2
81-104	3/8	13/16	-	1/2	3	10°RH	.02 x 45°	O	Wet	2

# 83-300 Series Stainless Steel

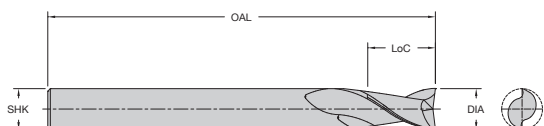
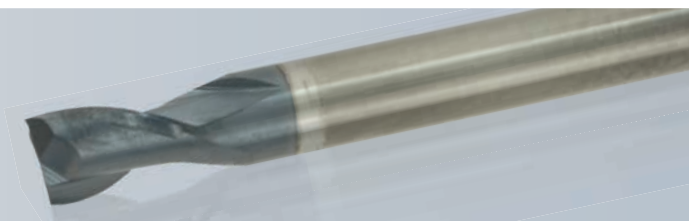

Special cutting geometry is required to cut stainless steel and achieve decent tool life. LMT Onsrud has developed a line of cutters which are capable of cutting stainless steel.

83-300 Series Two Flute - Solid Carbide Coated <b>Upcut</b> Spiral for Stainless Steel Product Offering					
Part Number	Cutting DIA (in)	LoC (in)	SHK DIA (in)	OAL (in)	Flutes
83-305AITiN	1/8	1/4	1/8	2	2
83-310AITiN	3/16	3/8	3/16	2-1/2	2
83-315AITiN	1/4	3/8	1/4	2-1/2	2
83-320AITiN	3/8	1/2	3/8	3	2

Cutting Parameters			
Part Number	RPM	Feedrate	Depth of Cut
83-305AITiN	18,000	18 IPM	.012
83-310AITiN	12,000	20 IPM	.020
83-315AITiN	9,000	25 IPM	.030
83-320AITiN	6,010	27 IPM	.045

# 85-800 Series CFRP Drill

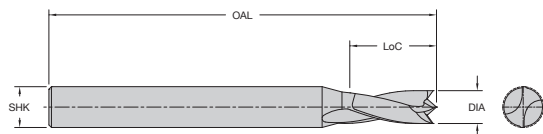
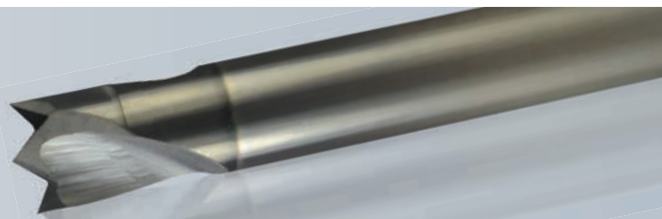

The CFRP drill is designed to ensure hole quality and diameter. The “W” point of the drill centers the drill to let the peripheral cutting edges shear the material producing a clean, tight tolerance hole without fraying or delamination. The drills are coated with a Diamond Like Carbon (DLC).

Fractional Drills					
Part Number	Cutting DIA (in)	LoC (in)	SHK DIA (in)	OAL (in)	Flutes
85-807	1/8 (0.1250)	0.500	1/8	3	2
85-808	9/64 (0.1406)	0.500	3/16	3	2
85-809	5/32 (0.1563)	0.500	3/16	3	2
85-810	11/64 (0.1719)	0.500	3/16	3	2
85-811	3/16 (0.1875)	0.500	3/16	3	2
85-812	13/64 (0.2031)	0.500	1/4	3	2
85-813	7/32 (0.2188)	0.500	1/4	3	2
85-814	15/64 (0.2344)	0.500	1/4	3	2
85-815	1/4 (0.2500)	0.500	1/4	3	2
85-816	17/64 (0.2656)	0.500	5/16	3	2
85-817	9/32 (0.2813)	0.500	5/16	3	2
85-818	19/64 (0.2969)	0.500	5/16	3	2
85-819	5/16 (0.3125)	0.500	5/16	3	2
85-820	21/64 (0.3281)	0.500	3/8	3	2
85-821	11/32 (0.3438)	0.500	3/8	3	2
85-822	23/64 (0.3594)	0.500	3/8	3	2
85-823	3/8 (0.3750)	0.500	3/8	3	2
85-827	7/16 (0.4375)	0.500	7/16	3	2
85-831	1/2 (0.5000)	0.500	1/2	3	2

Metric Drills					
Part Number	Cutting DIA (mm)	LoC (mm)	SHK DIA (mm)	OAL (mm)	Flutes
85-961	3.00 (0.1181)	12.000	3	76	2
85-963	4.00 (0.1575)	12.000	4	76	2
85-965	5.00 (0.1969)	12.000	5	76	2
85-967	6.00 (0.2362)	12.000	6	76	2
85-971	8.00 (0.3150)	12.000	8	76	2
85-975	10.00 (0.3937)	12.000	10	76	2
85-979	12.00 (0.4724)	12.000	12	76	2

Number Drills					
Part Number	Cutting DIA (in)	LoC (in)	SHK DIA (in)	OAL (in)	Flutes
85-876	1 (0.2280)	0.500	1/4	3	2
85-877	2 (0.2210)	0.500	1/4	3	2
85-878	3 (0.2130)	0.500	1/4	3	2
85-879	4 (0.2090)	0.500	1/4	3	2
85-880	5 (0.2055)	0.500	1/4	3	2
85-881	6 (0.2040)	0.500	1/4	3	2
85-882	7 (0.2010)	0.500	1/4	3	2
85-883	8 (0.1990)	0.500	1/4	3	2
85-884	9 (0.1960)	0.500	1/4	3	2
85-885	10 (0.1935)	0.500	1/4	3	2
85-886	11 (0.1910)	0.500	1/4	3	2
85-887	12 (0.1890)	0.500	1/4	3	2
85-888	13 (0.1850)	0.500	3/16	3	2
85-889	14 (0.1820)	0.500	3/16	3	2
85-890	15 (0.1800)	0.500	3/16	3	2
85-891	16 (0.1770)	0.500	3/16	3	2
85-892	17 (0.1730)	0.500	3/16	3	2
85-893	18 (0.1695)	0.500	3/16	3	2
85-894	19 (0.1660)	0.500	3/16	3	2
85-895	20 (0.1610)	0.500	3/16	3	2
85-896	21 (0.1590)	0.500	3/16	3	2

Number Drills (Cont.)					
Part Number	Cutting DIA (in)	LoC (in)	SHK DIA (in)	OAL (in)	Flutes
85-897	22 (0.1570)	0.500	3/16	3	2
85-898	23 (0.1540)	0.500	5/32	3	2
85-899	24 (0.1520)	0.500	5/32	3	2
85-900	25 (0.1495)	0.500	5/32	3	2
85-901	26 (0.1470)	0.500	5/32	3	2
85-902	27 (0.1440)	0.500	5/32	3	2
85-903	28 (0.1405)	0.500	5/32	3	2
85-904	29 (0.1360)	0.500	5/32	3	2
85-905	30 (0.1285)	0.500	5/32	3	2
85-906	31 (0.1200)	0.500	1/8	2-1/2	2
85-907	32 (0.1160)	0.500	1/8	2-1/2	2
85-908	33 (0.1130)	0.500	1/8	2-1/2	2
85-909	34 (0.1110)	0.500	1/8	2-1/2	2
85-910	35 (0.1100)	0.500	1/8	2-1/2	2
85-911	36 (0.1065)	0.500	1/8	2-1/2	2
85-912	37 (0.1040)	0.500	1/8	2-1/2	2
85-913	38 (0.1015)	0.500	1/8	2-1/2	2
85-914	39 (0.0995)	0.500	1/8	2-1/2	2
85-915	40 (0.0980)	0.500	1/8	2-1/2	2
85-916	41 (0.0960)	0.500	1/8	2-1/2	2

# 86-150 Series DFC Aerospace Composite Drill

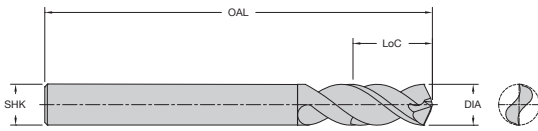

Carbon Fiber Reinforced (CFRP) drills produce a clean tight tolerance hole without fraying or delamination. Top-quality point grind ensures fiber shearing and prevents delamination on hole entry and exit. Enhanced diamond coating to protect cutting edges resulting in less tool changes.

86-150 Series DFC Aerospace Composite Drill (ACD) Product Offering						
Part Number	Cutting DIA (inch)	Cutting DIA (mm)	LoC (inch)	Shank DIA (inch)	OAL (inch)	Flutes
86-152	0.1000	2.54	1	1/4	3	2
86-154	0.1295	3.29	1	1/4	3	2
86-156	0.1620	4.11	1	1/4	3	2
86-158	0.1920	4.88	1	1/4	3	2
86-160	0.2220	5.64	1	1/4	3	2
86-162	0.2510	6.38	1	1/4	3	2
86-164	0.3135	7.96	1	5/16	3	2
86-166	0.3760	9.55	1	3/8	3	2
86-168	0.4385	11.14	1	7/16	3	2
86-170	0.5010	12.73	1	1/2	3	2

# 91-000/91-100 Series Spoilboard Surfacing Cutters

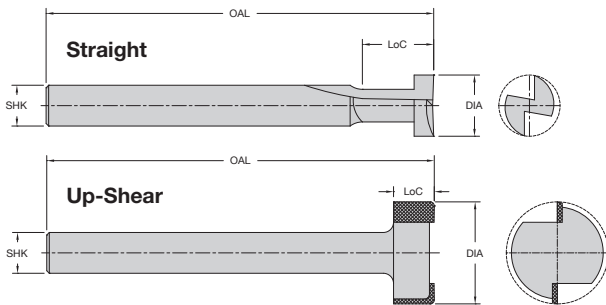

Designed for surfacing MDF, particleboard and balsa core where "flow through" or "high flow" fixturing is employed using large capacity vacuum pumps. This method of surfacing spoilboards allows for much faster table planing.

Spare Parts	
Part Number	Description
91-125	Insert 10/pk
91-127	Radius Insert 10/pk
91-130	Screw M4 (Old Version)
91-133	Screw M5
91-136	Wrench (T20)

*These tools are dynamically balanced and approved for use on CNC routers.  
Max RPM 18,000  
1/8" Depth of cut MAX.*

91-000/91-100 Series Spoilboard Surfacing Cutters (Straight) Product Offering				
Part Number	Cutting DIA (in)	LoC (in)	SHK DIA (in)	Flutes
91-000*	1-1/4	1/2	1-1/2	2
91-102	2-1/2	1/2	2	2
91-106	4	3/4	2-1/4	3

\* = Carbide Tipped

91-000/91-100 Series Spoilboard Surfacing Cutters (Up-Shear) Product Offering				
Part Number	Cutting DIA (in)	LoC (in)	SHK DIA (in)	Flutes
91-104	2-1/2	1/2	2	2
91-108	4	3/4	2-1/4	3
91-112 <sup>2</sup>	2-1/2	1/2	2	3
91-114 <sup>2</sup>	4	3/4	2-1/4	3

<sup>2</sup> Radius edges excellent for plastic and aluminum surfacing.

Note: 91-102, 91-104, 91-106 & 91-108 use 91-125 insert and 91-133 screw  
91-112 & 91-114 use 91-127 insert and 91-133 screw

<sup>•</sup> 2-1/2" diameter tools should be fed at 200-600 IPM at 12,000-16,000 RPM.

<sup>•</sup> 4" diameter tools should be fed at 200-600 IPM at 12,000-14,000 RPM.

<sup>\*</sup> Do Not Exceed 1/8" Depth Per Pass

# Cutting Tool Accessories



LMT Onsrud's mission is to provide cutting tool solutions that exceed our customers' expectations. Many times the solution also includes accessory products, such as cleaners and collets.



## 33-00 Series Fiber Adapter Bushing

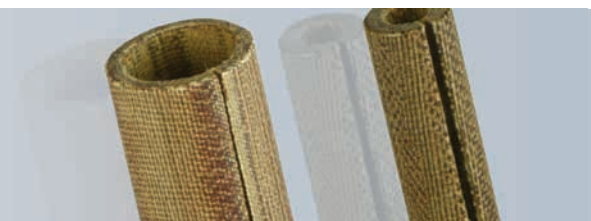

Used to downsize the bore for smaller shank diameters. Bushings are not recommended for production routing. They should be used only as a temporary substitute for the proper size collet.

- Temporary collet downsizing

33-00 Series Fiber Adapter Bushing Product Offering

Part Number	OD	Hole	Length
33-01	1/4	1/8	1-1/4
33-02	1/4	3/16	1-1/4
33-03	1/2	1/4	1-1/2
33-04	1/2	5/16	1-1/2
33-05	1/2	3/8	1-1/2

## 33-10 Series Collet Brush Kit



33-10 Series Collet Brush Kit

Part Number	Description
33-10	Collet Brush Kit: 1/4"-3/4" (includes 4 brushes in tube)
33-15	1/4" Brush
33-16	3/8" Brush
33-17	1/2" Brush

33-10 Series Collet Brush Kit

Part Number	Description
33-18	3/4" Brush
33-19	1" Brush
33-25	Collet Brush Kit: 1/4"-1" (includes 5 Brushes in Tube)
33-28	Brass Brush

## 33-21 Series Cleaning Solvent & Rust Protector



RUST FREE™ is a cleaner designed to provide a simple solution to your collet cleaning needs. Use T-9™ to protect parts from rust and corrosion. Designed to be used after RUST FREE™-use on collets and tool holders.

33-21 Series Cleaning Solvent & Rust Protector

Part Number	Description
33-21	Rust Free 8.45oz and T-9 4oz drip

## 33-30 Series Tool Extender



Designed to increase the overall reach of 3/8" and smaller router bits. These extensions are used mainly on CNC routers when routing three dimensional parts.

- Collet Pocket T.I.R. 0.0001"
- Nut Included

33-30 Series Tool Extender								
Part Number	EXT OAL	SHK DIA	SHK LGTH	HEAD DIA	COLLET	Spare Parts		WRENCH
						NUT	SET SCREW	
33-32	6-9/16	1/2	5-1/2	5/8	ER11	34-721	33-701	34-761
33-34	6-1/4	5/8	5-1/2	5/8	ER11	34-721	33-701	34-761
33-36	7	1/2	5-1/2	7/8	ER16	34-722	33-701	34-762
33-38	6-9/16	3/4	5-1/2	7/8	ER16	34-722	33-701	34-762
33-31	7	1/2	5-1/2	1-1/8	ER20	34-723	33-701	34-763
33-35	7	3/4	5-1/2	1-1/8	ER20	34-723	33-701	34-763
33-37	6-5/8	1	5-1/2	1-1/8	ER20	34-723	33-701	34-763
33-39	5-1/2	3/4	4	1-3/8	ER25	34-724	33-702	34-764

**NOTE:** Tool extenders should be cut off to required length before use.

Extension should not exceed a 4 to 1 ratio. The 4 being the length and the 1 being the diameter. I.E. a 1/2" shank should not extend out over 2" in front of the holder. Recommended Spindle Speed 15,000 to 18,000 RPM.

## 33-60 Series Spindle Taper Wiper



Spindle taper wipers are used to ensure clean spindle taper before installing collet chucks into CNC router spindles.

33-60 Series Spindle Taper Wiper					
Part Number	TYPE	TOTAL LENGTH	TAPER LENGTH	HANDLE DIA	TAPER MAX DIA
33-60	ISO-30	6-5/8	2-3/8	1	1-1/4
33-62	ISO-40	7-1/2	3-1/16	1	1-3/4
33-66	HSK-63F	6-1/2	1-1/4	1	N/A

## 33-70 Series ISO Toolholders for CNC Routers



- Balanced to 25,000 RPM at G2.5
- T.I.R 0.0001" or better from taper to collet pocket
- Nut and pull stud included

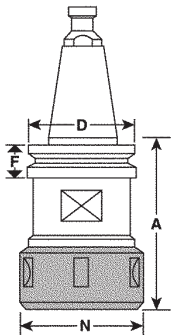

**Note:**  
Measure the "A" dimension with the collet in the nut.  
Dimensions in Millimeters.

33-70 Series ISO Toolholders for CNC Routers Product Offering

Part Number	Description	D (mm)	A (mm)	N (mm)	Spare Parts		Wrench
					Collet Nut	Pull Stud	
33-73	ISO 30 x ER 32-50mm	50	50	50	34-705	33-114	34-757
33-75	ISO 30 x ER 32-63mm	50	63	50	34-705	33-112	34-757
33-77	ISO 30 x ER 32-90mm	50	90	50	34-705	33-112	34-757
33-79	ISO 30 x ER 40-57mm	50	57	63	34-706	33-112	34-758
33-78	ISO 40 x ER 40-70mm	63.55	70	63	34-706	33-118	34-758
33-80	SK-30 x SYOZ 25 tool holder	50	63	60	34-708	-	-

## 33-80 Series BT Toolholders for CNC Routers



- Balanced to 25,000 RPM at G2.5
- T.I.R 0.0001" or better from taper to collet pocket
- Nut and pull stud included

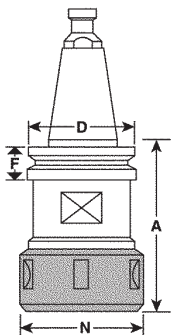

**Note:**  
Measure the "A" dimension with the collet in the nut.  
Dimensions in Millimeters.

33-80 Series BT Toolholders for CNC Routers Product Offering

Part Number	Description	D (mm)	A (mm)	F (mm)	N (mm)	Spare Parts		
						Collet Nut	Pull Stud	Set Screw
33-81	BT 30 x ER 32-60mm w/o slots	46	60	20	50	34-705	33-111	33-702
33-82	BT 30 x ER 32-90mm w/o slots	46	90	20	50	34-705	33-111	33-702
33-84	BT 35 x ER 32-76mm	53	76	22	50	34-705	33-117	-
33-85	BT 30 x ER 32-70mm	46	70	20	50	34-705	33-117	33-702
33-86	BT 40 x ER 32-70mm	50	70	25.3	50	34-705	-	33-702
33-87	BT 40 x ER 40-80mm	50	80	25.3	63	34-706	-	33-702

## 33-90 Series HSK 63F Toolholders for CNC Routers



- Balanced to 25,000 RPM at G2.5
- T.I.R 0.0001" or better from taper to collet pocket
- Nut and pull stud included

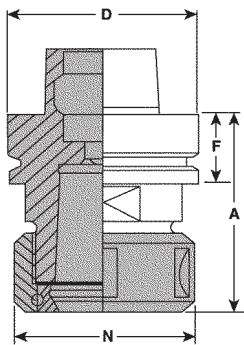

**Note:** Measure the "A" dimension with the collet in the nut. Dimensions in Millimeters

33-90 Series HSK 63F Toolholders for CNC Routers Product Offering

Part Number	Description	D (mm)	A (mm)	F (mm)	N (mm)	Spare Parts	
						Collet Nut	Wrench
33-90	HSK 50F x ER32-80mm	50	80	26	50	34-705	34-757
33-91	HSK 63F x ER40-76mm	63	76	26	63	34-706	34-758
33-92	HSK 63F x ER40-90mm	63	90	26	63	34-706	34-758
33-93	HSK 63 F x SYOZ 25-80mm	63	80	26	60	34-708	34-758
33-94	HSK 63 F x ER32-70mm	63	70	26	50	34-705	34-757
33-95	HSK 63 F x ER40-125mm	63	125	26	63	34-706	34-758

## 34-50 Series Collet Life Plug



Collet plugs are designed to keep full grip collets from collapsing in the back when the router bit shank does not fill the full grip collet completely.

34-50 Series Collet Life Plug Product Offering

Part Number	Size	Part Number	Size
34-51	1/4	34-54	5/8
34-52	3/8	34-55	3/4
34-53	1/2		

# Collets ER Precision Inch

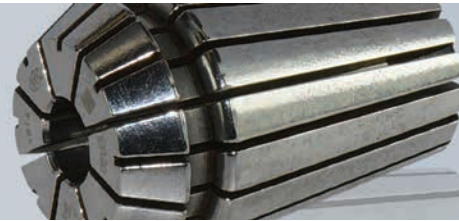

- Standard 0.0002" T.I.R.
- Collapse range: 0.039"

Collets   ER Precision Inch							
Collet ID	34-60 ER11	34-70 ER16	34-90 ER20	34-150 ER25	34-200 ER32	34-250 ER40	Collet Range
1/16"	34-61	34-71					.043-.062"
3/32"	34-62	34-72	34-92	34-151	34-201		.054-.093"
1/8"	34-63	34-73	34-93	34-152	34-202	34-251	.086-.125"
5/32"	34-64	34-74	34-94	34-153	34-203		.117-.156"
3/16"	34-65	34-75	34-95	34-154	34-204	34-252	.148-.187"
7/32"	34-66	34-76	34-96	34-155	34-205		.179-.218"
1/4"	34-67	34-77	34-97	34-156	34-206	34-253	.211-.250"
9/32"		34-78	34-98	34-157	34-207		.242-.281"
5/16"		34-79	34-99	34-158	34-208	34-254	.273-.312"
11/32"		34-80	34-100	34-159	34-209		.304-.343"
3/8"		34-81	34-101	34-160	34-210	34-255	.336-.375"
13/32"		34-82	34-102	34-161	34-211		.367-.406"
7/16"			34-103	34-162	34-212	34-256	.398-.437"
15/32"			34-104	34-163	34-213		.429-.468"
1/2"			34-105	34-164	34-214	34-257	.461-.500"
17/32"				34-165	34-215		.492-.531"
9/16"				34-166	34-216	34-258	.523-.562"
19/32"				34-167	34-217		.554-.593"
5/8"				34-168	34-218	34-259	.586-.625"
21/32"					34-219		.617-.656"
11/16"					34-220	34-260	.648-.687"
23/32"					34-221		.679-.718"
3/4"					34-222	34-261	.711-.750"
7/8"						34-262	.836-.875"
1"						34-263	.961-1.000"

# Collets ER Precision Metric

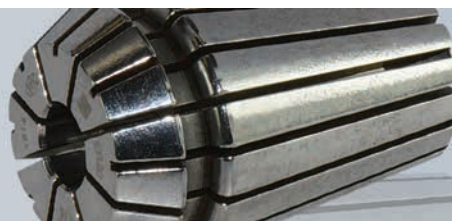

- Standard 0.0002" T.I.R.
- Collapse range: 0.039"

Collets   ER Precision Metric						
Collet ID (mm)	34-300 ER20	34-350 ER25	34-400 ER32	34-450 ER40	Inch	Collet Range
1-2	34-301	34-351			1/16"	.039-.079"
2-3	34-302	34-352	34-401		7/64"	.079-.118"
3-4	34-303	34-353	34-402	34-451	1/8"	.118-.157"
4-5	34-304	34-354	34-403	34-452	3/16"	.157-.197"
5-6	34-305	34-355	34-404	34-453	7/32"	.197-.236"
6-7	34-306	34-356	34-405	34-454	1/4"	.236-.276"
7-8	34-307	34-357	34-406	34-455	5/16"	.276-.315"
8-9	34-308	34-358	34-407	34-456	11/32"	.315-.354"
9-10	34-309	34-359	34-408	34-457	3/8"	.354-.394"
10-11	34-310	34-360	34-409	34-458	13/32"	.394-.433"
11-12	34-311	34-361	34-410	34-459	7/16"	.433-.472"
12-13	34-312	34-362	34-411	34-460	1/2"	.472-.512"
13-14		34-363	34-412	34-461	17/32"	.512-.551"
14-15		34-364	34-413	34-462	9/16"	.551-.591"
15-16		34-365	34-414	34-463	5/8"	.591-.630"
16-17			34-415	34-464	21/32"	.630-.669"
17-18			34-416	34-465	11/16"	.669-.709"
18-19			34-417	34-466	3/4"	.709-.748"
19-20			34-418	34-467	25/32"	.748-.787"
20-21				34-468	13/16"	.787-.827"
21-22				34-469	27/32"	.827-.866"
22-23				34-470	7/8"	.866-.906"
23-24				34-471	15/16"	.906-.945"
24-25				34-472	31/32"	.945-.984"
25-26				34-473	1"	.984-1.024"

## 33-110 Series Pull Studs for CNC Router

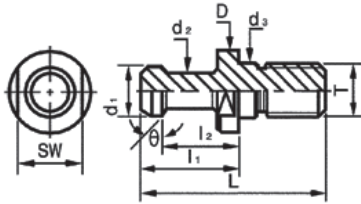

33-110 Series Pull Studs for CNC Router Product Offering

Part Number	Type	D (mm)	d1 (mm)	d2 (mm)	d3 (mm)	L (mm)	l1 (mm)	l2 (mm)	θ	T
33-111	KOMO 30-A 12.5	17	13	9	12.5	44	23.4	18.2	15°	M12
33-112	DAT 30- A	17	13	9	13	44	24	19	15°	M12
33-113	Colombo 30- Ball	17	12.8	9	13	44	24	19	45°	M12
33-114	HSD ISO 30	17	12	8	13	44	23.9	-	radius	M12
33-115	DAT-A PULL STUD	36	28	21	25	74	34	25	30°	M24
33-117	BT 35- Heian	20	13	8.5	12.5	43	28	22.5	-	M12
33-118	DAT 40 – A	23	19	14	17	54	26	20	15°	M16

## 33-120 Series Cat 40 Precision Toolholder



- Balanced to 25,000 RPM at G2.5
- T.I.R 0.0001" or better from taper to collet pocket
- Nut included

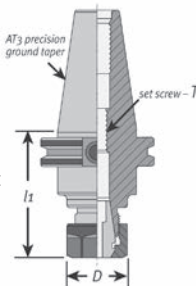

33-120 Series Cat 40 Precision Toolholder Product Offering

Part Number	Description	L1	D	Spare Parts		Wrench
				Collet Nut	Set Screw	
33-120	CAT 40 x ER 32-4	4	1.97	34-705	33-702	34-757
33-121	CAT 40 x ER 32-6	6	1.97	34-705	33-702	34-757
33-122	CAT 40 x ER 32-8	8	2.48	34-705	33-702	34-757
33-123	CAT 40 x ER 40-4	4	2.48	34-706	33-703	34-758

# 34-170 HSK63F Hydraulic Holders and Reduction Sleeves



- Balanced to 25,000 RPM at G2.5
- T.I.R. 0.0001" measured from taper to bore

34-170 Series HSK63F Hydraulic Holders								
Part #	Description	d1 (mm)	D1 (mm)	D2 (mm)	L (mm)	L1 (mm)	L2 (mm)	Thread
34-171	HSK63F-HC19.05-85	19 (.75")	42	50	85	43	42	M16x1.0
34-172	HSK63F-HC25.4-120	25 (1.0")	57	63	120	59	40	M16x1.0

Reduction Sleeves	
Part #	Description
34-175	3/4-1/8 Reduction Sleeve
34-176	3/4-3/16 Reduction Sleeve
34-177	3/4-1/4 Reduction Sleeve
34-178	3/4-5/16 Reduction Sleeve
34-179	3/4-3/8 Reduction Sleeve
34-180	3/4-1/2 Reduction Sleeve
34-181	3/4-5/8 Reduction Sleeve

**NOTE:** Assemble the cutting tool into the sleeve first, then insert the assembly into the hydraulic toolholder. Do not load the sleeve and collet separately. Turn the clamping screw clockwise to apply the clamping pressure.

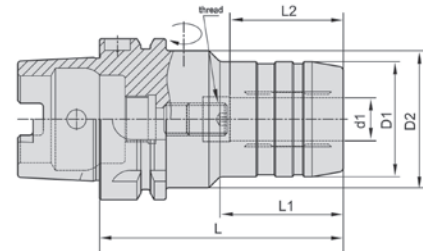

# 34-550 Series Perske (SYOZ)/DIN6388 Collets and Nuts



Snap collet into the nut before screwing nut onto spindle or collet holder. SYOZ 20-L=34 D=20 • SYOZ 25-L=52 D=35

34-550 Perske (SYOZ)/DIN6388 Collets Product Offering		
Collet ID	Part # for SYOZ 20	Part # for SYOZ 25
1/8"	34-551	34-601
3/16"	34-552	34-602
1/4"	34-553	34-603
5/16"	34-554	34-604
3/8"	34-555	34-605
7/16"	34-556	34-606
1/2"	34-557	34-607
9/16"	-	34-608

34-550 Perske (SYOZ)/DIN6388 Collets Product Offering		
Collet ID	Part # for SYOZ 20	Part # for SYOZ 25
5/8"	-	34-609
3/4"	-	34-610
7/8"	-	34-611
1"	-	34-612
10 mm	34-558	34-613
16 mm	-	34-614
20 mm	-	34-615
25 mm	-	34-616

34-550 Perske Nuts Product Offering	
Part Number	Description
34-707	SYOZ 20 RH Collet Nut
34-708	SYOZ 25 RH Collet Nut

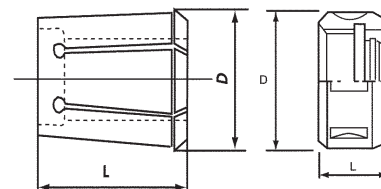



## 34-700 Series Ultra High-Speed ER Coated Nuts

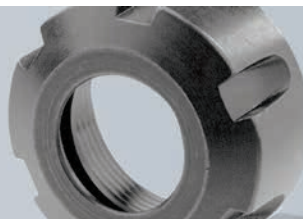

Use RH-B nuts for applications where speeds exceed 15,000 RPM's to maintain tool balance. RH-B series nuts are manufactured to the closest tolerance for ultra high speeds. The eccentric ring is perfectly round and all parts of the nut are totally ground.

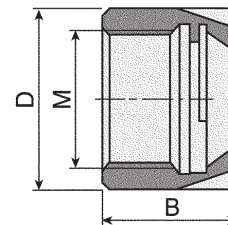

### Features and Benefits

- B Nuts Balanced to 25,000 RPM
- Mini Nuts Balanced to 20,000 RPM

34-700 Ultra High-Speed ER Coated Nuts Product Offering							
Part #	Description	D (mm)	B (mm)	M (mm)	Max Speed	Wrench	*Max Torque
34-701	ER RH 11 B Nut	19	11.8	M14 x 0.75	70,000	34-751	20 ft/lbs
34-702	ER RH 16 B Nut	32	18.0	M22 x 1.5	65,000	34-754	42 ft/lbs
34-703	ER RH 20 B Nut	35	19.5	M25 x 1.5	60,000	34-755	59 ft/lbs
34-704	ER RH 25 B Nut	42	20.5	M32 x 1.5	55,000	34-756	77 ft/lbs
34-705	ER RH 32 B Nut	50	23.0	M40 x 1.5	50,000	34-757	100 ft/lbs
34-706	ER RH 40 B Nut	63	26.0	M50 x 1.5	40,000	34-758	130 ft/lbs
34-720	ER 8 Mini Nut	12	11.0	M10 x 0.75	20,000	34-760	7 ft/lbs
34-721	ER 11 Mini Nut	16	12.0	M13 x 0.75	20,000	34-761	12 ft/lbs
34-722	ER 16 Mini Nut	22	18.0	M19 x 1.0	20,000	34-762	20 ft/lbs
34-723	ER 20 Mini Nut	28	19.5	M24 x 1.0	20,000	34-763	22 ft/lbs
34-724	ER 25 Mini Nut	36	21.0	M30 x 1.0	20,000	34-764	26 ft/lbs

## 34-743 Series Dust Cover

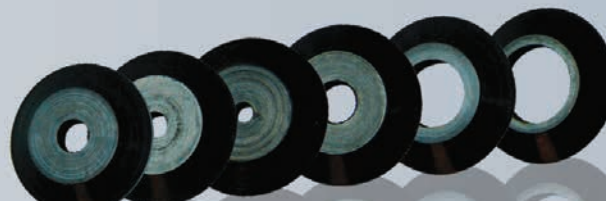

- Keeps dust and chips from entering collet.
- Keeps tool balanced.



34-743 Series Dust Cover Product Offering	
Part Number	Description
34-740	Dust cover for 3/16" tool shank
34-741	Dust cover for 1/4" tool shank
34-742	Dust cover for 5/16" tool shank
34-743	Dust cover for 3/8" tool shank
34-744	Dust cover for 1/2" tool shank
34-745	Dust cover for 5/8" tool shank
34-746	Dust cover for 3/4" tool shank

## 34-750 Series Hand Wrenches for Collet Nuts

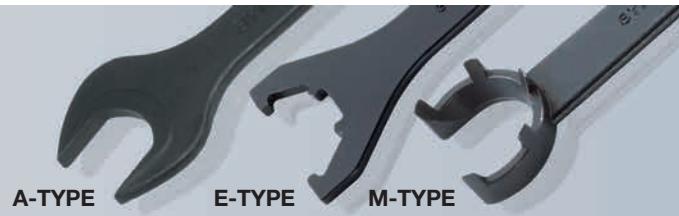

34-750 Series Hand Wrenches for Collet Nuts Product Offering		
Part Number	Description	Nut Type
34-751	ER 11-A Wrench	A (Hex)
34-752	ER 16-A Wrench	A (Hex)
34-753	ER 20-A Wrench	A (Hex)
34-754	ER 16-E Wrench	Slotted
34-755	ER 20-E Wrench	Slotted
34-756	ER 25-E Wrench	Slotted
34-757	ER 32-E Wrench	Slotted
34-758	ER 40-E Wrench	Slotted
34-760	ER 8-M Wrench	Mini
34-761	ER 11-M Wrench	Mini
34-762	ER 16-M Wrench	Mini
34-763	ER 20-M Wrench	Mini
34-764	ER 25-M Wrench	Mini

## 34-800 Series Torque Wrench

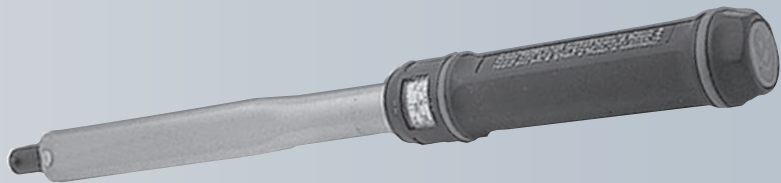

34-800 Series Torque Wrench Product Offering					
Part Number	Description	Torque Range	Length	Weight	Spigot
34-801	Torque Wrench	30-150 ft/lbs	16.5"	1.75 lbs.	16mm round
34-802	Torque Wrench	45-228 ft/lbs	21.5"	2.5 lbs.	16mm round

## 34-810 Series Adapter Socket



Use with Torque Wrench (34-800 Series) and Socket (34-820 Series)

34-810 Adapter Socket Product Offering	
Part Number	Description
34-810	3/8" Square Drive
34-812	1/2" Square Drive

## 34-820 Series Pull Stud Socket

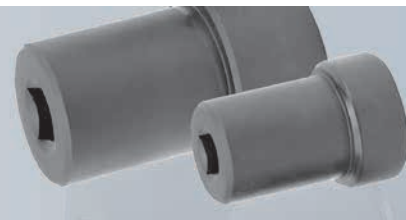

Use with Torque Wrench (34-800 Series) and Adapter (34-810 Series)

34-820 Series Pull Stud Socket Product Offering			
Part Number	Description	Square Drive	Torque
34-820	BT30	3/8"	36 ft/lbs
34-822	ISO 30	3/8"	36 ft/lbs
34-824	All 40 Taper	3/8"	76 ft/lbs

## 34-850 Series Collet Keys for Torque Wrenches



Use with Torque Wrench (34-800 Series)

34-850 Collet Keys for Torque Wrenches Product Offering			
Part #	Collet Nut Size	Wrench Type	Torque
34-851	ER 16 Hex	Hex	42 ft/lbs
34-852	ER 20 Hex	Hex	59 ft/lbs
34-853	ER 25 Slotted	Slotted	95 ft/lbs
34-854	ER 32 Slotted	Slotted	100 ft/lbs
34-855	ER 40 Slotted	Slotted	130 ft/lbs
34-856	SYOZ 25/TG 100	Hook	90 ft/lbs

## 34-920 Series ER Dust Seal Nuts and Dust Seal



- Balanced to 25,000 RPM
- Internal Dust Seals extend the life of a collet.
- Must use Internal Dust Seal with Dust Seal Nuts. Can not be used separately.

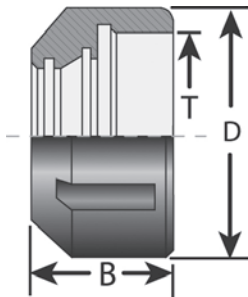

34-920 ER Dust Seal Nuts and Dust Seals Product Offering

Part #	Description	D (mm)	B (mm)	T	Wrench	Recommended Torque
34-921	ER16 Dust Seal Nut	32	22.5	M22x1.5	34-754	42 ft/lbs
34-922	ER20 Dust Seal Nut	35	24	M25x1.5	34-755	59 ft/lbs
34-923	ER25 Dust Seal Nut	42	25	M32x1.5	34-756	77 ft/lbs
34-924	ER32 Dust Seal Nut	50	27.5	M40x1.5	34-757	100 ft/lbs
34-925	ER40 Dust Seal Nut	63	30.7	M50x1.5	34-758	130 ft/lbs

Internal Dust Seals

	ER16	ER20	ER25	ER32	ER40
For Shank Size	Part #	Part #	Part #	Part #	Part #
1/8"	34-930	34-935	34-941	34-948	34-962
3/16"	34-931	34-936	34-942	34-949	34-963
1/4"	34-932	34-937	34-943	34-955	34-964
5/16"	34-933	34-938	34-944	34-956	34-965
3/8"	34-934	34-939	34-945	34-957	34-966
1/2"		34-940	34-946	34-958	34-967
5/8"			34-947	34-959	34-968
3/4"				34-961	34-969
1"					34-970

## 34-950 Series Spindle Drill Adapters

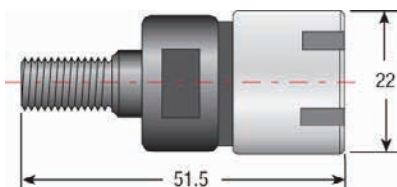

34-950 Series Spindle Drill Adapters Product Offering

Part Number	Description	Shank	Collet	Capacity	Thred
34-950	Inline Multi Spindles Drill Adapters	M10 x 1.05	ER16	3/8 or 10mm	RIGHT
34-951	Inline Multi Spindles Drill Adapters	M10 x 1.05	ER16	3/8 or 10mm	LEFT

# Technical Information



LMT Onsrud has over 70 years of experience routing/machining a wide-range of materials. LMT Onsrud's strengths are extensive engineering resources and technical expertise and service. LMT Onsrud has the deep, solution-based knowledge of how to solve complex problems.

## TOOL SELECTION

### TOOL MATERIAL

- Solid Carbide: Primarily used in CNC operations. Material provides best rigidity and long tool life.
- Carbide Tipped: Incorporates the wear resistance of carbide and the toughness of a HSS body-mainly hand held.
- HSS: Primarily used in hand routing. Material provides a tough body and sharper cutting edge.
- PCD: Long life in abrasive materials.

### FLUTE GEOMETRY

- Straight flute: Offers a neutral cutting action-highest force.
- Upcut flute: Provides the best surface finish and allows for good chip extraction. May cause part lifting if vacuum or fixturing is not sufficient.
- Downcut flute: Provides a downward force which helps eliminate part lifting. Chip rewelding MAY occur if there is no space below the part for chip expansion.
- Compression: Used for laminated materials, produces a good top and bottom finish on the part.

### NUMBER OF FLUTES

- Single Flute: Allows for larger chiploads in softer materials
- Two Flute: Allows for better part finish in harder materials.
- Multiple Flutes: Allows for an even better part finish in harder materials.

**Note:** As the number of cutting edges increase, your feed rate should increase to prevent burning and premature tool dulling.

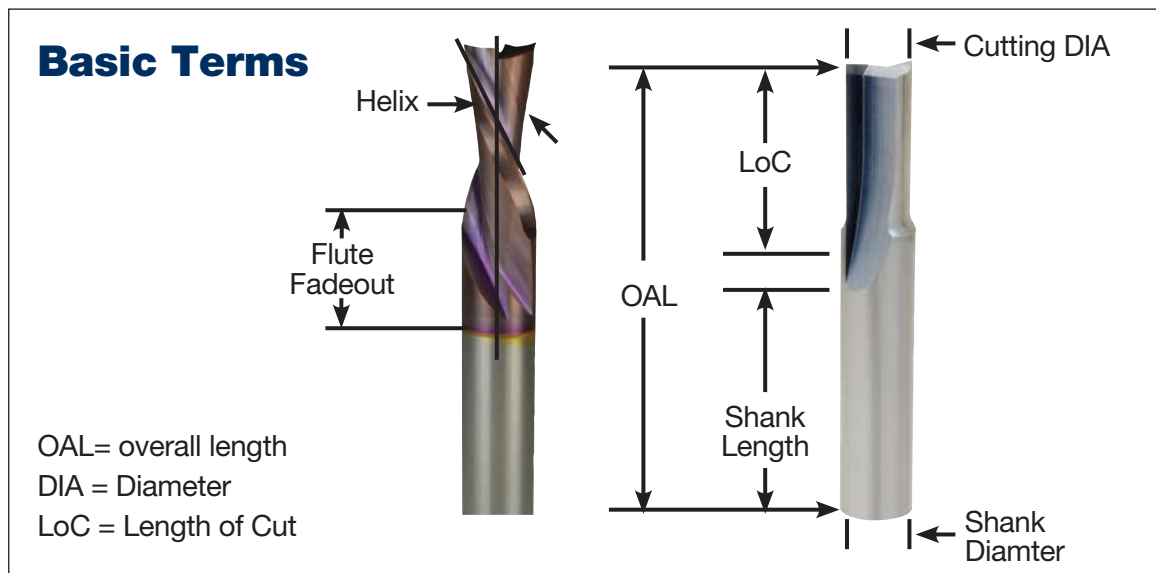

## OPTIMIZING SPEED AND FEEDS

1. Start off using the recommended chipload and RPM for the material you are cutting.
2. Increase the feedrate until the part finish starts to decrease or you risk moving the part off the vacuum. Decrease the feed by 10%.
3. Next decrease your RPM by a set increment until your surface finish deteriorates again. Once this happens increase your RPM until the finish is acceptable.
4. You have now optimized your speed and feed by taking the largest chip possible.

**Note:** This should be done in the first sheet of material to prevent tool dulling due to excessive heat.

### TOOL HEAT

If a feed rate is too low, heat will be generated causing the cutting edge to break down and dull quickly. To check this, run a nest of parts and stop the spindle. When the spindle has stopped rotating, carefully feel the tool's temperature. It should be at or near room temperature. If the tool is hot, review "Optimizing Speed and Feeds".

## FIXTURING METHODS

### FLOW THROUGH VACUUM

This style uses LDF (Low Density Fiberboard) or MDF (Medium Density Fiberboard) as a sacrificial surface for sheet material to be cut on. The porous nature of LDF or MDF allows vacuum to pass through allowing the material to be held in place for machining. As parts are cut out of the sheet material, vacuum loss starts to occur from the slot produced by the cutting tool. This can lead to part lifting or movement especially in small parts. Cutter diameter will also influence part movement. A 1/2 diameter tool will exert 25% more lateral pressure than a 3/8 diameter tool.

When cutting small parts in sheet material, one may want to consider tab or skin cutting to prevent part movement.

### DEDICATED SPOILBOARD

Dedicated spoilboards are used for reoccurring production runs where optimal cycle times are needed. This work holding method creates vacuum chambers in the sacrificial board specifically to the shape of the parts being cut. This elimination of vacuum loss relates to improved cycle times and part finish.

#### STEPS TO CREATE A DEDICATED SPOILBOARD:

1. Surface both sides of your MDF board.
2. Lay out the part pattern on the MDF and determine quantity that will fit.
3. Cut the part profile into the MDF board using a larger diameter tool than would normally cut the part. Make your slot depth 1 to 1.5 times the cutter diameter.
4. A gasket groove must be cut next inside the part profile to create a vacuum seal. The groove should be 1/2 the gasket material thickness to allow for proper compression.
5. A grid pattern must then be cut inside the gasket groove to distribute the vacuum evenly through out the vacuum area.
6. Drill holes throughout the pattern in the intersections of the vacuum grid until there is no resistance on your vacuum gage on the machine table.
7. Seal the board using rubberized coatings, polyurethane sealers or a sanding sealer to prevent vacuum from passing through the board in unwanted areas.
8. Apply the gasket tape.

These operations sound time consuming. It will be for your first board. Once you become familiar making these fixtures, you will make up for it in your cycle time reductions and part finish. A lot of headaches and problems can be resolved by using the proper work holding.

### RAISED SPOILBOARD

This is generally used where secondary operations are needed and the spoilboard will interfere with the secondary tool. Raised spoilboards are another type of fixturing that works well for routing parts such as circles from squares where the scrap or fall off is of such a size to be potentially harmful to the tool and or operator when it is cut free. A raised spoilboard should make sure the fall off would not interfere with the first and second tool and that the fall off would be free and clear of the tool path.

### SPOILBOARD PREPARATION

Good part holding is essential for routing products and the following steps will ensure you properly surface your new spoilboard to get maximum air flow.

1. Place your new sheet of MDF on the router table.
2. Turn on your vacuum
3. Use the 91-100 series spoilboard cutter and surface the top edge.
4. Flip over the sheet of MDF and turn the vacuum on again
5. Surface the top side.
6. Tape or seal the edges of the spoilboard to prevent air leakage.

The following benefits will be achieved if you surface your spoilboard daily:

- A level spoilboard allows for consistent cuts
- Removes grooves caused by routing
- Reduce vacuum loss due to clogged pores a the material surface due to dust and chips
- Preventing material warpage caused by humidity in summer time

## Proper Spoilboard Techniques

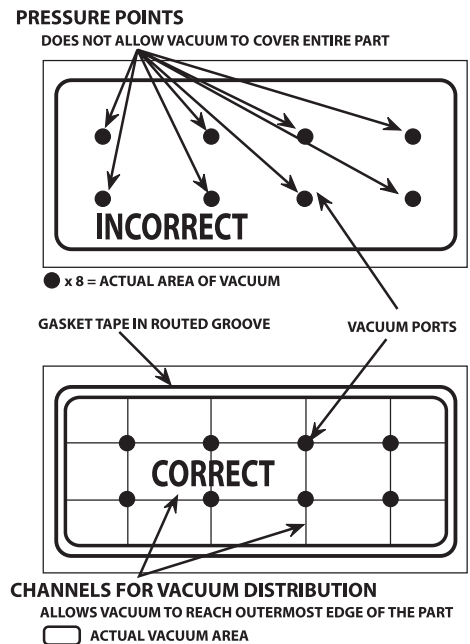

## COLLETING

### COLLET LIFE SPAN

Collets have a life span of 3 months if used 8 hours a day. Replacing the collets will ensure your operation runs consistently and prevents tool breakage. When inserting a tool into the collet make sure the flute fadeout does not enter the collet. This will cause run out and potentially lead to tool breakage. To ensure proper clamping, the tool shank should fill, at the minimum, 80% of the depth of the collet. If this can not be achieved, use a collet life plug (34-50 series) to ensure a proper clamping effect.

### COLLET MAINTENANCE

Cleaning is an essential part of collet maintenance. As material is cut it causes the collet, tool holder, collet nut and spindle to become dirty. This causes your tool to cut in an elliptical fashion which will decrease tool life and cause inconsistency in your operation. Collets, tool holder, and collet nut should be cleaned daily using the Rust Free solvent and a brass brush (33-21 and 33-10 series). Refer to the critical areas diagram to see which surfaces must be clean.

### CLEANING INSTRUCTIONS

1. Spray the cleaner on the surface and allow it to soak for a minute.
2. Use a brass brush to clean the surface thoroughly.
3. Rinse off using distilled alcohol. Feel the surface using your fingers to make sure the surface is clean.
4. Apply a small amount of Lubricant T-9 (33-21 series) to prevent rusting.

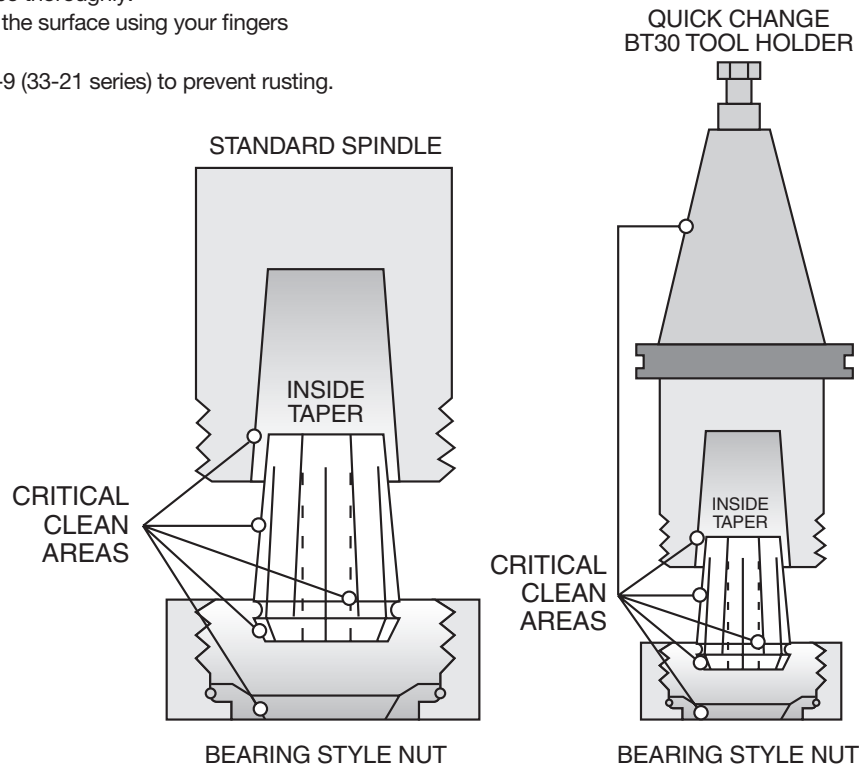

## TOOL BREAKAGE

If a condition arises where multiple tools should break, follow these steps to solve your problem:

1. Are you using the proper tool for the job?
2. Make sure your collets and tool holders are clean and the tool is colleted properly.
3. Check your speed and feed (is your tool hot?)
4. Is your depth of cut too excessive for the material you are cutting?
5. Do you have any part movement?
6. Do you have ample part hold down?
7. Stop running parts and check with your distributor or LMT Onsrud's Technical Support.

If you have to contact your distributor or Technical Support, have the following information:

1. Machine being used.
2. Material being cut.
3. Part number of tool along with the batch number which is below the part number etched on shank of tool.
4. Speed / Feed / Depth of cut.
5. Where did the tool break (flute, shank, or in the collet)?
6. How long did the tool work before it broke?
7. Have you done this operation in the past using this tool?



### COLLET MEASURING GUIDE

The best way to tell what type of collet the machine has is to measure the length of the collet. Almost all collets have a distinctive length and diameter.

Collet Series	Length	(OD) Diameter	Onsrud Series	Page
ER 11	18mm (0.708")	11.5mm (0.45")	34-60	-
ER 16	27.5mm (1.08")	17mm (0.67")	34-70	-
ER 20	31.5mm (1.24")	21mm (0.83")	34-90/ 34-300	-
ER 25	34mm (1.34")	26mm (1.02")	34-150/34-350	-
ER 32	40mm (1.57")	33mm (1.3")	34-200/34-400	-
ER 40	46mm (1.81")	41mm (1.61")	34-250/34-450	-
ER 50	60mm (2.36")	52mm (2.05")	-	-
EOC 8	26mm (1.026")	14.4mm (0.567")	-	-
SYOZ 20-RDO 20-407E-EOC12	34mm (1.34")	20mm (0.78")	34-550	-
EOC 16-RDO 25	40mm (1.57")	25.5mm (1")	-	-
SYOZ 25-RDO 35-462E	52mm (2.06")	35mm (1.38")	34-550	-
EOC 32	60mm (2.36")	43.7mm (1.72")	-	-
TG 75	47mm (1.85")	27mm (1.06")	-	-
TG 100	60mm (2.36")	35mm (1.38")	-	-
<b>Shoda Collets</b>				
Shoda 20mm	52mm (2.06")	20mm (Back side)	-	-
Shoda Piggyback	52mm (2.06")	16mm (Back side)	-	-
Super Shoda	40mm (1.58")	23.5mm 0.925" (OD)	-	-
Shoda 24mm	52mm (2.06")	24mm (Back side)	-	-
SS-18	30mm (1.18")	19.5mm (.766")	-	-
<b>Heian Collets</b>				
HN-24mm	55mm (2.16")	24mm(1.14")(Back side)	-	-
HN-29mm	55mm (2.16")	24mm(1.14")(Back side)	-	-
HN-Piggyback	36.5mm (1.43")	22mm (.886")	-	-
<b>Pin Router Collets</b>				
A421-69	43.62mm (1.72")	28mm (1.1")	-	-
A450-	41.3mm (1.62")	36mm (1.41")	-	-

### TOOL HOLDER MEASURING GUIDE

Use this guide for measuring your tools to determine what you need to re-order.

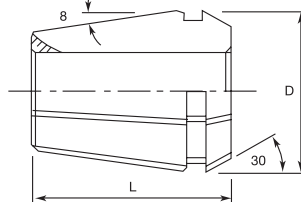

ER Series Collet

Toolholder Dimensions	Pull Stud Dimensions	Collet Dimensions
D = _____	P = _____	D = _____
F = _____	A = _____	L = _____
W = _____	L = _____	
A = _____	R = _____	
N = _____		

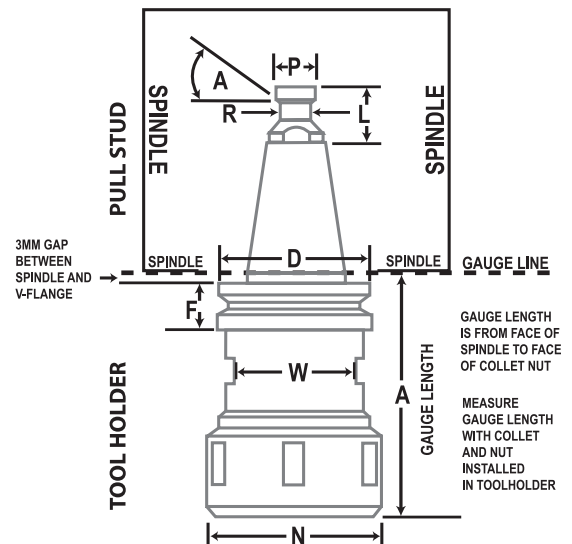

SW

# Soft Wood Cutting Data Recommendations

APPLICATION	GOOD	BETTER	BEST
Single Pass	52-200/57-200	60-300/60-350	60-100C
Roughing	52-200/57-200	60-800/60-900	60-000
Finishing		60-300/60-350	60-200

**DEPTH OF CUT:** 1 x D Use recommended chip load  
 2 x D Reduce chip load by 25%  
 3 x D Reduce chip load by 50%

Recommended Chip Load per Tooth by Cutting Diameter (in)																						
Series	Cut	1/16	3/32	1/8	5/32	3/16	7/32	1/4	5/16	3/8	7/16	1/2	9/16	5/8	3/4	7/8	1	1 1/8	1 1/4	1 1/2	1 3/4	2
10-00	1 x D	.004-.006	.004-.006	.005-.007				.007-.009		.008-.010												
37-00/37-20	Varies							.004-.006														
37-50	1/2 x D					.003-.006		.003-.006		.003-.006												
37-60	1/2 x D									.004-.006		.004-.006			.006-.008		.008-.010					
37-80	Varies																.004-.006		.004-.006*			.004-.006**
40-50	1 1/2 X D											.003-.005										
40-000	1 x D			.002-.004	.002-.004	.003-.005		.004-.006	.004-.006	.005-.007												
40-100	1 x D			.005-.007		.005-.007	.005-.007	.006-.008	.006-.008	.007-.009		.008-.010			.010-.012							
52-200/57-200	1 x D			.006-.008	.006-.008	.006-.008	.006-.008	.007-.009	.007-.009	.008-.010	.008-.010	.009-.011	.009-.011	.010-.012	.011-.013							
52-400/57-400	1 x D				.006-.008	.006-.008		.007-.009	.007-.009	.008-.010		.009-.011										
52-900	1 x D							.007-.009		.008-.010		.009-.011										
57-200MD	1 x D							.009-.011		.010-.012		.011-.013										
56-200	1 x D			.004-.006	.004-.006	.005-.007	.005-.007	.006-.008	.006-.008	.007-.009	.008-.010	.009-.011			.010-.012							
57-900	1 x D							.007-.009		.008-.010		.009-.011										
60-000 (LH)	1 x D									.013-.015		.015-.017		.017-.019	.019-.021							
60-000 (HH)	1 x D									.016-.018		.018-.020		.020-.022	.022-.024							
60-090	1 x D													.005-.007								
60-100MW	1 x D			.011-.013		.013-.015		.018-.020		.020-.022		.022-.024		.024-.026	.026-.028							
60-100C	1 x D									.024-.026		.026-.028		.028-.030	.030-.032							
60-100MC	1 x D									.019-.021		.021-.023										
60-100PLR	1 x D									.021-.023		.023-.025										
60-200	1 x D							.005-.007		.006-.008		.007-.009			.008-.010							
60-300	1 x D									.024-.026		.026-.028		.028-.030	.030-.032							
60-350	1 x D									.017-.019		.019-.021			.021-.023							
60-600	1 x D											.019-.021			.023-.025							
60-700	1 x D											.019-.021		.021-.023	.023-.025							
60-800	1 x D									.017-.019		.019-.021		.021-.023	.023-.025							
60-900	1 x D									.017-.019		.018-.020										
60-950	1 x D									.024-.026		.026-.028										
61-000	1 x D			.008-.010	.008-.010	.009-.011	.009-.011	.010-.012	.010-.012	.011-.013	.011-.013	.012-.014										
61-200	1 x D			.008-.010				.010-.012	.010-.012	.011-.013		.012-.014										
63-200	1 x D			.003-.005				.005-.007														
64-000/65-000	1 x D	.001-.003		.002-.004		.003-.006		.004-.006		.005-.007												
68-100	1 x D									.014-.015		.015-.016										
77-100	1 x D			.003-.005				.005-.007														

\* = 16,000 RPM  
 \*\* = 15,000 RPM

**FORMULAS:** Chip Load = Feed Rate / (RPM x # of cutting edges)  
 Feed Rate (IPM) = RPM x # of cutting edges x chip load  
 Speed (RPM) = Feed Rate / (# of cutting edges x chip load)

**DEFINITIONS:** IPM = Inches Per Minute

HP

# Hard Wood Cutting Data Recommendations

APPLICATION	GOOD	BETTER	BEST
Single Pass	52-200/57-200	60-300/60-350	60-100C
Roughing	52-200/57-200	60-800/60-900	60-000
Finishing		60-300/60-350	60-200

**DEPTH OF CUT:** 1 x D Use recommended chip load  
 2 x D Reduce chip load by 25%  
 3 x D Reduce chip load by 50%

Recommended Chip Load per Tooth by Cutting Diameter (in)																							
Series	Cut	1/16	3/32	1/8	5/32	3/16	7/32	1/4	5/16	3/8	7/16	1/2	9/16	5/8	3/4	7/8	1	1 1/8	1 1/4	1 1/2	1 3/4	2	
37-00/37-20	Varies							.004-.006															
37-50	1/2 CED					.003-.006		.003-.006		.003-.006													
37-60	1/2 CED									.004-.006		.004-.006			.006-.008		.008-.010						
37-80	Varies																.004-.006		.004-.006*				.004-.006**
40-50	1 1/2											.003-.005											
40-000	1 x D			.006-.008	.006-.008	.007-.009		.008-.010	.008-.010	.009-.007													
40-100	1 x D			.004-.006		.005-.007	.005-.007	.005-.007	.006-.008	.006-.008		.007-.009			.009-.011								
48-000	1 x D					.004-.006		.005-.007	.005-.007	.005-.007		.006-.008		.007-.009	.008-.010	.009-.011	.010-.012						
52-200/57-200	1 x D			.003-.005	.003-.005	.004-.006	.004-.006	.005-.007	.005-.007	.006-.008	.006-.008	.007-.009	.007-.008	.008-.010	.009-.011								
52-700	1 x D			.002-.004		.003-.005		.004-.006		.005-.007		.006-.008		.007-.009	.008-.010		.009-.011						
57-200MD	1 x D							.009-.011		.010-.012		.011-.013											
52-400/57-400	1 x D				.004-.006	.004-.006		.005-.007	.005-.007	.006-.008		.007-.009											
52-900	1 x D							.006-.008		.007-.009		.007-.009											
56-200	1 x D			.003-.005	.003-.005	.004-.006	.004-.006	.005-.007	.005-.007	.006-.008		.007-.009			.009-.011								
57-900	1 x D							.005-.007		.006-.008		.007-.009											
60-000 (LH)	1 x D									.013-.015		.014-.016		.016-.018	.017-.019								
60-000 (HH)	1 x D									.015-.017		.017-.019		.019-.021	.021-.023								
60-090	1 x D													.005-.007									
60-100MW	1 x D			.010-.012		.012-.014		.014-.016		.016-.018		.018-.020		.020-.022	.022-.024								
60-100C	1 x D									.019-.021		.021-.023		.023-.025	.025-.027								
60-100MC	1 x D									.019-.021		.021-.023											
60-100PLR	1 x D									.021-.023		.023-.025											
60-200	1 x D							.005-.007		.006-.008		.007-.009			.008-.010								
60-300	1 x D									.024-.026		.026-.028		.028-.030	.030-.032								
60-350	1 x D									.018-.020		.020-.022		.022-.025	.024-.026								
60-600	1 x D											.018-.020			.022-.024								
60-700	1 x D											.018-.020		.020-.022	.022-.024								
60-800	1 x D									.017-.019		.019-.021		.021-.023	.023-.025								
60-900	1 x D									.015-.017		.017-.019			.019-.021								
60-950	1 x D									.019-.021		.021-.023											
61-200	1 x D			.007-.009				.009-.011	.009-.011	.010-.012													
63-200	1 x D			.003-.005				.005-.007															
64-000/65-000	1 x D	.001-.003		.002-.004		.003-.005		.004-.006		.005-.007													
68-100	1 x D									.010-.012		.011-.013		.012-.014	.013-.015								
77-100	1 x D			.003-.005				.005-.007															

\* = 16,000 RPM  
 \*\* = 15,000 RPM

**FORMULAS:** Chip Load = Feed Rate / (RPM x # of cutting edges)  
 Feed Rate (IPM) = RPM x # of cutting edges x chip load  
 Speed (RPM) = Feed Rate / (# of cutting edges x chip load)

**DEFINITIONS:** IPM = Inches Per Minute

# MDF Cutting Data Recommendations

CW

APPLICATION	GOOD	BETTER	BEST
Single Pass	52-200/57-200	60-100MW	60-100C
Roughing		60-800	60-000
Finishing			60-200

**DEPTH OF CUT:** 1 x D Use recommended chip load  
 2 x D Reduce chip load by 25%  
 3 x D Reduce chip load by 50%

Recommended Chip Load per Tooth by Cutting Diameter (in)																						
Series	Cut	1/16	3/32	1/8	5/32	3/16	7/32	1/4	5/16	3/8	7/16	1/2	9/16	5/8	3/4	7/8	1	1 1/8	1 1/4	1 1/2	1 3/4	2
37-00/37-20	Varies							.004-.006														
37-50	1/2 CED					.003-.006		.003-.006		.003-.006												
37-60	1/2 CED									.004-.006		.004-.006			.006-.008		.008-.010					
37-80	Varies																.004-.006		.004-.006*			.004-.006**
40-50	1 1/2											.003-.005										
47-00	1 x D															.004-.006			.004-.006	.004-.006		
48-000	1 x D					.004-.006		.005-.007	.005-.007	.005-.007		.006-.008		.006-.008	.007-.009	.008-.010	.009-.011					
52-200/57-200	1 x D		.005-.007	.005-.007	.006-.008	.006-.008	.006-.008	.006-.008	.007-.009	.007-.009	.007-.009	.008-.010	.008-.010	.009-.011	.009-.011							
57-200MD	1 x D							.009-.011		.010-.012		.011-.013										
52-400/57-400	1 x D			.003-.005	.004-.006			.005-.007	.005-.007	.006-.008		.008-.010	.009-.011	.010-.012	.011-.013	.012-.014						
52-900	1 x D							.006-.008		.007-.009		.008-.010										
56-200	1 x D		.003-.005	.003-.005	.004-.006	.004-.006		.005-.007	.005-.007	.006-.008		.007-.009			.009-.011							
57-900	1 x D							.006-.008		.007-.009		.008-.010										
60-000 (LH)	1 x D									.012-.014		.013-.015		.014-.016	.016-.018							
60-000 (RH)	1 x D									.017-.019		.018-.020		.020-.022	.023-.025							
60-090	1 x D													.004-.006								
60-100MW	1 x D		.010-.012		.010-.012			.013-.015		.014-.016		.016-.018		.018-.020	.019-.021							
60-100C	1 x D									.017-.019		.018-.020		.020-.022	.023-.025							
60-100MC	1 x D									.019-.021		.021-.023										
60-100PLR	1 x D									.021-.023		.023-.025										
60-200	1 x D							.004-.006		.005-.007		.005-.007			.006-.008							
60-300	1 x D									.017-.019		.018-.020		.020-.022	.023-.025							
60-350	1 x D									.014-.016		.016-.018		.017-.019	.019-.021							
60-600	1 x D											.020-.022		.022-.024	.024-.026							
60-700	1 x D													.020-.022	.022-.024	.024-.026						
60-800	1 x D									.017-.019		.019-.021		.021-.023	.023-.025							
60-900	1 x D									.017-.019		.019-.021										
60-950	1 x D									.017-.019		.018-.020										
61-200	1 x D		.007-.009		.008-.010			.009-.011	.009-.011	.010-.012		.011-.013										
63-200	1 x D		.003-.005					.005-.007														
64-000/65-000	1 x D	.001-.003	.002-.004		.003-.005			.004-.006		.005-.007												
68-100	1 x D									.008-.010		.012-.014		.015-.017	.018-.020							
77-100	1 x D		.003-.005					.005-.007														

\* = 16,000 RPM  
 \*\* = 15,000 RPM

**FORMULAS:** Chip Load = Feed Rate / (RPM x # of cutting edges)  
 Feed Rate (IPM) = RPM x # of cutting edges x chip load  
 Speed (RPM) = Feed Rate / (# of cutting edges x chip load)

**DEFINITIONS:** IPM = Inches Per Minute

CW

# Soft Plywood Cutting Data Recommendations

APPLICATION	GOOD	BETTER	BEST
Single Pass	52-200/57-200	60-100MW	60-100C
Roughing		60-800	60-000
Finishing			60-200

**DEPTH OF CUT:** 1 x D Use recommended chip load  
 2 x D Reduce chip load by 25%  
 3 x D Reduce chip load by 50%

Recommended Chip Load per Tooth by Cutting Diameter (in)																				
Series	Cut	1/16	1/8	5/32	3/16	7/32	1/4	5/16	3/8	7/16	1/2	9/16	5/8	3/4	7/8	1	1-1/8	1-1/4	1-1/2	2
37-00/37-20	Varies						.004-.006													
37-50	1/2 x D				.003-.006		.003-.006		.003-.006											
37-60	1/2 x D								.004-.006		.004-.006			.006-.008		.008-.010				
37-80	Varies															.004-.006		.004-.006*		.004-.006**
40-50	1 1/2 x D										.003-.005									
48-000	1 x D				.005-.007		.005-.007	.006-.008	.006-.008		.007-.009		.008-.010	.009-.011	.010-.012	.011-.013				
52-200/57-200	1 x D		.005-.007	.005-.007	.006-.008	.006-.008	.006-.008	.006-.008	.007-.009	.007-.009	.008-.010	.008-.010	.009-.011	.009-.011						
52-900	1 x D						.006-.008		.007-.009		.008-.010									
56-200	1 x D		.003-.005	.003-.005	.004-.006	.004-.006	.005-.007	.005-.007	.006-.008		.007-.009			.009-.011						
57-200MD	1 x D						.009-.011		.010-.012		.011-.013									
60-000 (LH)	1 x D								.014-.016		.016-.018		.018-.020	.020-.022						
60-000 (HH)	1 x D								.017-.019		.019-.021		.021-.023	.023-.025						
60-090	1 x D												.003-.005							
60-100MW	1 x D		.013-.015		.014-.016		.017-.019		.019-.021		.021-.023		.023-.025	.025-.027						
60-100C	1 x D								.022-.024		.024-.026		.026-.028	.028-.030						
60-100MC	1 x D								.019-.021		.021-.023									
60-100PLR	1 x D								.021-.023		.023-.025									
60-300	1 x D								.022-.024		.024-.026		.026-.028	.028-.030						
60-350	1 x D								.020-.022		.022-.024		.024-.026	.026-.028						
60-600	1 x D										.028-.030		.030-.032	.032-.034						
60-700	1 x D										.028-.030		.030-.032	.032-.034						
60-800	1 x D								.017-.019		.019-.021		.021-.023	.023-.025						
60-900	1 x D								.017-.019		.019-.021		.021-.023	.023-.025						
60-950	1 x D								.022-.024		.024-.026									
61-200	1 x D		.006-.008		.007-.009		.008-.010	.008-.010	.009-.011		.010-.012									
63-200	1 x D		.003-.005				.005-.007													
64-000/65-000	1 x D	.001-.003	.002-.004		.003-.005		.004-.006		.005-.007											
68-100									.010-.012		.012-.014		.017-.019	.018-.020						

\* = 16,000 RPM  
 \*\* = 15,000 RPM

**FORMULAS:** Chip Load = Feed Rate / (RPM x # of cutting edges)  
 Feed Rate (IPM) = RPM x # of cutting edges x chip load  
 Speed (RPM) = Feed Rate / (# of cutting edges x chip load)

**DEFINITIONS:** IPM = Inches Per Minute

# Hard Plywood Cutting Data Recommendations

CW

APPLICATION	GOOD	BETTER	BEST
Single Pass	60-100MW	60-100C	60-100MC
Roughing		60-800	60-000

**DEPTH OF CUT:** 1 x D Use recommended chip load  
 2 x D Reduce chip load by 25%  
 3 x D Reduce chip load by 50%

Recommended Chip Load per Tooth by Cutting Diameter (in)																						
Series	Cut	1/16	3/32	1/8	5/32	3/16	7/32	1/4	5/16	3/8	7/16	1/2	9/16	5/8	3/4	7/8	1	1 1/8	1 1/4	1 1/2	1 3/4	2
37-00/37-20	Varies							.004-.006														
37-50	1/2 x D					.003-.006		.003-.006		.003-.006												
37-60	1/2 x D									.004-.006		.004-.006			.006-.008		.008-.010					
37-80	Varies																.004-.006		.004-.006*			.004-.006**
40-50	1 1/2											.003-.005										
48-000	1 x D					.004-.006		.005-.007	.005-.007	.006-.008		.007-.009		.008-.010	.009-.011	.010-.012	.011-.013					
52-200	1 x D			.005-.007	.005-.007	.006-.008	.006-.008	.006-.008	.006-.008	.007-.009	.007-.009	.008-.010	.008-.010	.009-.011	.009-.011							
52-900	1 x D							.006-.008		.007-.009		.008-.010										
56-200	1 x D			.003-.005	.003-.005	.004-.006	.004-.006	.005-.007	.005-.007	.006-.008		.007-.009			.009-.011							
57-200	1 x D			.005-.007	.005-.007	.006-.008	.006-.008	.006-.008	.006-.008	.007-.009	.007-.009	.008-.010	.008-.010	.009-.011	.009-.011							
57-200MD	1 x D							.009-.011		.010-.012		.011-.013										
60-000 (LH)	1 x D									.014-.016		.016-.018		.018-.020	.020-.022							
60-000 (HH)	1 x D									.017-.019		.019-.021		.021-.023	.023-.025							
60-090	1 x D													.003-.005								
60-100MW	1 x D			.012-.014		.012-.014		.014-.016		.016-.018		.018-.020		.020-.022	.022-.024							
60-100C	1 x D									.019-.021		.021-.023		.023-.025	.025-.027							
60-100MC	1 x D									.019-.021		.021-.023										
60-100PLR	1 x D									.021-.023		.023-.025										
60-300	1 x D									.019-.021		.021-.023		.023-.025	.025-.027							
60-350	1 x D									.018-.020		.020-.022		.022-.025	.024-.026							
60-600	1 x D											.027-.029		.030-.032	.032-.034							
60-700	1 x D											.027-.029		.029-.031	.032-.034							
60-800	1 x D									.017-.019		.019-.021		.021-.023	.023-.025							
60-900	1 x D									.017-.019		.019-.021										
60-950	1 x D									.019-.021		.021-.023										
61-200	1 x D			.005-.007				.007-.009	.007-.009	.008-.010		.009-.011										
63-200	1 x D			.003-.005				.005-.007														
64-000/65-000	1 x D	.001-.003		.002-.004		.003-.005		.004-.006		.005-.007												
68-100	1 x D									.010-.012		.012-.014		.017-.019	.018-.020							
77-100				.003-.005				.005-.007														

\* = 16,000 RPM  
 \*\* = 15,000 RPM

**FORMULAS:** Chip Load = Feed Rate / (RPM x # of cutting edges)  
 Feed Rate (IPM) = RPM x # of cutting edges x chip load  
 Speed (RPM) = Feed Rate / (# of cutting edges x chip load)

**DEFINITIONS:** IPM = Inches Per Minute

LW

# Laminated Chipboard Cutting Data Recommendations

APPLICATION	GOOD	BETTER	BEST
Single Pass	60-100MW	60-100MC	60-100PLR

**DEPTH OF CUT:** Greater than 3 x D, reduce chip load by 25%

Recommended Chip Load per Tooth by Cutting Diameter (in)																	
Series	Cut	1/8	3/16	7/32	1/4	5/16	3/8	1/2	9/16	5/8	3/4	7/8	1	1-1/8	1-1/4	1-1/2	2
37-00/37-20	Varies				.004-.006												
37-50	1/2 CED		.003-.006		.003-.006		.003-.006										
37-60	1/2 CED						.004-.006		.004-.006			.006-.008					
37-80	Varies												.004-.006			.004-.006	.004-.006
48-000	1 x D				.006-.008	.006-.008	.007-.009	.008-.010		.009-.011	.010-.012	.011-.013	.012-.014				
57-200		.003-.005	.003-.005	.004-.006	.004-.006	.005-.007	.005-.007	.006-.008		.007-.009	.007-.008						
57-200MD					.009-.011		.010-.012	.011-.013									
60-100MW	1 x D	.013-.015	.014-.016		.017-.019		.019-.021	.021-.023		.025-.027	.027-.029						
60-100C	1 x D						.022-.024	.024-.026		.026-.028	.028-.030						
60-100MC	1 x D						.019-.021	.021-.023									
60-100PLR	1 x D						.021-.023	.023-.025									
60-600	1 x D							.028-.030		.030-.032	.032-.034						
68-100	1 x D						.008-.010	.012-.014		.016-.018	.019-.021						

**FORMULAS:** Chip Load = Feed Rate / (RPM x # of cutting edges)  
 Feed Rate (IPM) = RPM x # of cutting edges x chip load  
 Speed (RPM) = Feed Rate / (# of cutting edges x chip load)

**DEFINITIONS:** IPM = Inches Per Minute

# Laminated Plywood Cutting Data Recommendations

APPLICATION	GOOD	BETTER	BEST
Single Pass	60-100MW	60-100MC	60-100PLR

**DEPTH OF CUT:** Greater than 3 x D, reduce chip load by 25%

Recommended Chip Load per Tooth by Cutting Diameter (in)																							
Series	Cut	1/16	3/32	1/8	5/32	3/16	7/32	1/4	5/16	3/8	7/16	1/2	9/16	5/8	3/4	7/8	1	1 1/8	1 1/4	1 1/2	1 3/4	2	
37-00/37-20	Varies							.004-.006															
37-50	1/2 CED					.003-.006		.003-.006		.003-.006													
37-60	1/2 CED									.004-.006		.004-.006			.006-.008		.008-.010						
37-80	Varies																.004-.006			.004-.006		.004-.006	
48-000	1 x D				.004-.006	.005-.007	.005-.007	.006-.008	.006-.008		.007-.009		.009-.011	.010-.012	.011-.013	.012-.014							
57-200	1 x D		.003-.005	.003-.005	.004-.006	.004-.006	.005-.007	.005-.007	.006-.008		.007-.009	.007-.008											
57-200MD	1 x D						.009-.011	.010-.012	.011-.013														
60-100MW	1 x D		.013-.015		.014-.016		.015-.017		.016-.018		.018-.020		.019-.021	.021-.023									
60-100C	1 x D								.019-.021		.021-.023		.023-.025	.025-.027									
60-100MC	1 x D								.019-.021		.021-.023												
60-100PLR	1 x D								.021-.023		.023-.025												
60-600	1 x D										.027-.029		.030-.032	.032-.034									
68-100	1 x D								.008-.010		.012-.014		.016-.018	.019-.021									

**FORMULAS:** Chip Load = Feed Rate / (RPM x # of cutting edges)  
 Feed Rate (IPM) = RPM x # of cutting edges x chip load  
 Speed (RPM) = Feed Rate / (# of cutting edges x chip load)

**DEFINITIONS:** IPM = Inches Per Minute

# Soft Plastic Cutting Data Recommendations

SP

**< 1/2 DIAMETER TOOL**

APPLICATION	GOOD	BETTER	BEST
Single Pass	61-000P	65-000	63-750
Roughing			60-000

**DEPTH OF CUT:** 1 x D Use recommended chip load  
 2 x D Reduce chip load by 25%  
 3 x D Reduce chip load by 50%

**≥ 1/2 DIAMETER TOOL**

APPLICATION	GOOD	BETTER	BEST
Single Pass	56-600	52-600	52-700
Roughing			60-000

Recommended Chip Load per Tooth by Cutting Diameter (in)																						
Series	Cut	1/16	3/32	1/8	5/32	3/16	7/32	1/4	5/16	3/8	7/16	1/2	9/16	5/8	3/4	7/8	1	1 1/8	1 1/4	1 1/2	1 3/4	2
10-00	1 x D	.002-.004		.004-.006		.006-.008		.006-.008		.007-.009		.008-.010										
37-00/37-20	Varies							.004-.006														
37-50*	1 x D					.003-.006		.003-.006														
37-60*	1 x D									.004-.006		.004-.006			.006-.008		.008-.010					
52-200B/BL	1 x D	.002-.004		.002-.004		.004-.006		.004-.006		.004-.006		.006-.008		.010-.012	.012-.014							
52-600	1 x D							.008-.010		.010-.012		.012-.014		.014-.016	.016-.018							
52-700	1 x D											.012-.014		.014-.016	.016-.018							
56-430	1 x D			.006-.008		.006-.008		.007-.009		.008-.010		.009-.011										
56-600	1 x D			.004-.006		.006-.008		.008-.010		.010-.012		.012-.014										
57-600	1 x D							.008-.010		.010-.012		.012-.014		.014-.016	.016-.018							
60-000	1 x D									.004-.006		.006-.008		.008-.012	.012-.016							
60-200	1 x D							.004-.006		.004-.006		.006-.010			.012-.016							
60-900	1 x D									.004-.006		.006-.008										
61-000P	1 x D			.004-.006		.006-.008		.008-.012		.014-.018		.018-.022										
61-400	1 x D			.017-.019		.017-.019		.018-.020		.019-.021		.020-.021										
62-750	1 x D			.004-.006		.006-.008		.008-.012		.008-.012		.010-.014										
62-850	1 x D			.004-.006		.006-.008		.008-.012		.008-.012		.010-.014										
63-500	1 x D	.002-.004		.004-.006		.005-.007		.006-.008		.007-.009												
63-750	1 x D	.002-.004		.004-.006		.006-.008		.008-.012		.008-.012		.010-.014										
63-850	1 x D	.002-.004		.004-.006		.006-.008		.008-.012		.008-.012		.010-.014										
64-000/65-000	1 x D	.002-.004		.004-.006		.006-.008		.008-.012		.008-.012												
65-200B/65-300B	1 x D	.002-.003		.002-.003		.003-.004		.003-.005	.003-.005	.004-.006		.006-.008										
66-000	1 x D							.004-.008		.004-.008		.004-.008										
66-200	1 x D							.004-.006		.006-.008												
66-300	1 x D			.002-.004				.004-.006		.006-.008		.006-.008										
77-100 (DE)	1 x D			.005-.007																		
77-100 (3E)	1 x D							.008-.010														

\* = 12,500 RPM

**NOTE:** To eliminate rewelding increase the feedrate or change to a single edge tool.  
 If using a downcut spiral and chip rewelding occurs, cut a slot in your spoilboard to allow the chips a place to expand.  
 Incorrect chiploads can lead to knife marks occurring.

**FORMULAS:** Chip Load = Feed Rate / (RPM x # of cutting edges)  
 Feed Rate = RPM x # of cutting edges x chip load  
 Speed (RPM) = Feed Rate / (# of cutting edges x chip load)

**DEFINITIONS:** IPM = Inches Per Minute



# Hard Plastic Cutting Data Recommendations

HP

**< 1/2 DIAMETER TOOL**

APPLICATION	GOOD	BETTER	BEST
Single Pass	56-000P	65-000	63-700
Roughing			60-000
Finishing			60-200

**DEPTH OF CUT:** 1 x D Use recommended chip load  
 2 x D Reduce chip load by 25%  
 3 x D Reduce chip load by 50%

**≥ 1/2 DIAMETER TOOL**

APPLICATION	GOOD	BETTER	BEST
Single Pass	56-000P	52-600	60-200
Roughing			60-000
Finishing			60-200

Recommended Chip Load per Tooth by Cutting Diameter (in)																							
Series	Cut	1/16	3/32	1/8	5/32	3/16	7/32	1/4	5/16	3/8	7/16	1/2	9/16	5/8	3/4	7/8	1	1 1/8	1 1/4	1 1/2	1 3/4	2	
37-00/37-20	Varies							.004-.006															
37-50	1 x D					.003-.006		.003-.006		.003-.006													
37-60	1 x D									.004-.006		.004-.006				.006-.008		.008-.010					
52-200B/BL	1 x D	.002-.004		.002-.004		.004-.006		.004-.006		.004-.006		.006-.008		.008-.010	.010-.012								
52-600	1 x D							.006-.008		.008-.010		.010-.012		.012-.014	.014-.016								
56-000	1 x D			.002-.004		.004-.006		.004-.006	.004-.006			.008-.010											
56-000P	1 x D			.002-.004		.004-.006		.004-.006		.006-.008		.008-.010											
56-430	1 x D			.005-.007		.005-.007		.006-.008		.007-.009		.008-.010											
56-450	1 x D					.005-.007		.006-.008		.007-.009		.008-.010											
56-600	1 x D			.003-.005		.005-.007		.007-.009		.009-.011		.011-.013											
57-600	1 x D							.006-.008		.008-.010		.010-.012											
60-000	1 x D									.004-.006		.006-.008		.008-.010	.012-.016								
60-200	1 x D							.004-.006		.004-.006		.006-.010			.012-.016								
60-900	1 x D									.004-.006		.006-.008											
61-000P	1 x D			.003-.005		.005-.007		.007-.011		.013-.017		.017-.021											
61-400	1 x D			.014-.016		.014-.016		.015-.017		.016-.018		.017-.019											
62-700	1 x D			.006-.008		.008-.010		.010-.012		.010-.012		.012-.016											
62-750	1 x D			.004-.006		.006-.008		.008-.012		.008-.012		.010-.014											
62-800	1 x D			.006-.008		.008-.010		.010-.012		.010-.012		.012-.016											
62-850	1 x D			.004-.006		.006-.008		.008-.012		.008-.012		.010-.014											
63-500	1 x D	.002-.004		.003-.005		.003-.005		.004-.006		.005-.007													
63-700	1 x D	.002-.004		.006-.008		.008-.010		.010-.012		.010-.012		.012-.016											
63-750	1 x D	.002-.004		.004-.006		.006-.008		.008-.012		.008-.012		.010-.014											
63-800	1 x D	.002-.004		.006-.008		.008-.010		.010-.012		.010-.012		.012-.016											
63-850	1 x D	.002-.004		.004-.006		.006-.008		.008-.012		.008-.012		.010-.014											
64-000/65-000	1 x D	.002-.004		.006-.008		.008-.010		.010-.012		.010-.012													
66-000	1 x D							.004-.008		.004-.008		.004-.008											
66-200	1 x D							.004-.006		.006-.008													
66-300	1 x D			.002-.004				.004-.006		.006-.008		.006-.008											
77-100 (DE)	1 x D			.005-.007																			
77-100 (SE)	1 x D							.008-.010															

**NOTE:** When chip rewelding occurs while cutting plastic, increase feedrate or go to a single edge tool. Incorrect chiploads can result in cratering.

**FORMULAS:** Chip Load = Feed Rate / (RPM x # of cutting edges)  
 Feed Rate (IPM) = RPM x # of cutting edges x chip load  
 Speed (RPM) = Feed Rate / (# of cutting edges x chip load)

**DEFINITIONS:** IPM = Inches Per Minute

# A Aluminum Cutting Data Recommendations

APPLICATION	GOOD	BETTER	BEST
<b>BLOCK</b>			
Single Pass	63-600	AMC 2 Flute	AMC 3 Flute
Roughing	AMC 2 Flute	AMC 3 Flute	AMC Rougher
Finishing		66-300	AMC
Slotting	63-600	AMC 2 Flute	AMC 3 Flute
Profile/Shape		52-200B	AMC
<b>SHEET</b>			
Single Pass	61-000	65-000	63-600
<b>EXTRUSION</b>			
Single Pass	63-600	81-000	81-100

**DEPTH OF CUT:** 1 x D Use recommended chip load  
 2 x D Reduce chip load by 25%  
 3 x D Reduce chip load by 50%

To view our complete line of **AMC Tools**, reference our **Milling Tools Catalog** which is available at [www.onsrud.com](http://www.onsrud.com)

Recommended Chip Load per Tooth by Cutting Diameter (in)																							
Series	Cut	1/16	3/32	1/8	5/32	3/16	7/32	1/4	5/16	3/8	7/16	1/2	9/16	5/8	3/4	7/8	1	1 1/8	1 1/4	1 1/2	1 3/4	2	
37-00/37-20	Varies							.004-.006															
37-70	Varies							.004-.006															
40-000*	1 x D			.005-.007		.005-.007		.006-.008	.006-.008	.007-.009													
40-100	1 x D			.001-.003		.001-.003		.002-.004	.002-.004	.003-.005		.004-.008			.006-.008								
49-000	1 x D			.001-.003						.003-.005													
52-000	1 x D			.003-.005		.003-.005		.004-.006		.006-.008		.010-.012											
52-200B/BL	1 x D	.002-.004		.003-.005		.003-.005		.004-.006		.006-.008		.010-.012		.012-.014	.014-.016								
57-000*	1 x D			.003-.005		.003-.005		.004-.006		.006-.008		.010-.012											
61-000	1 x D			.001-.003		.002-.005		.002-.005		.003-.007		.007-.009											
62-600	1 x D	.002-.004		.002-.004		.003-.006		.003-.006	.003-.006	.004-.008		.008-.010											
63-000	1 x D			.006-.008		.006-.008		.007-.009	.007-.009	.008-.010		.009-.011											
63-600	1 x D	.002-.004		.002-.004		.003-.006		.003-.006	.003-.006	.004-.008		.008-.010											
63-900	1 x D	.002-.004		.002-.004		.003-.006		.003-.006	.003-.006	.004-.008		.008-.010											
64-000/ 65-000	1 x D	.002-.004		.002-.004		.003-.006		.003-.006		.004-.008													
66-300	1 x D			.002-.004				.004-.006		.006-.008		.006-.008											
77-100	1 x D			.002-.004				.003-.005															
80-000	1 x D			.001-.003																			
81-000	1 x D								.004-.006	.004-.006													
81-100	1 x D								.002-.005	.003-.008		.003-.008											

\* 16,000 RPM

**NOTE:** When cutting soft aluminum a squirt of cutting fluid every now and then will help to eliminate chip rewelding and improve surface finish.

**FORMULAS:** Chip Load = Feed Rate / (RPM x # of cutting edges)  
 Feed Rate (IPM) = RPM x # of cutting edges x chip load  
 Speed (RPM) = Feed Rate / (# of cutting edges x chip load)

**DEFINITIONS:** IPM = Inches Per Minute

SSP

# Solid Surface Cutting Data Recommendations

**DEPTH OF CUT:** 1 x D Use recommended chip load  
 2 x D Reduce chip load by 25%  
 3 x D Reduce chip load by 50%

Recommended Chip Load per Tooth by Cutting Diameter (in)																	
Series	Cut	1/16	3/32	1/8	5/32	3/16	7/32	1/4	5/16	3/8	7/16	1/2	9/16	5/8	3/4	7/8	1
37-50	1 x D					.003-.006		.003-.006		.003-.006							
37-60	1 x D									.004-.006		.004-.006			.006-.008		.008-.010
52-000	1 x D			.003-.006		.003-.006		.004-.006		.008-.010		.012-.014					
52-200B/BL	1 x D	.002-.004		.002-.004		.002-.004		.004-.006		.004-.006		.006-.008		.008-.010	.010-.012		
52-600	1 x D							.004-.006		.006-.008		.008-.010		.008-.010	.010-.012		
52-700	1 x D			.002-.004		.003-.005		.004-.006		.005-.007		.006-.008		.007-.009	.008-.010		.009-.011
56-000P	1 x D			.002-.004		.002-.004		.004-.006		.006-.008		.008-.010					
56-450	1 x D			.002-.004		.002-.004		.003-.005		.004-.006		.005-.007					
57-000	1 x D			.002-.004		.002-.004		.003-.005		.004-.006		.005-.007					
57-600	1 x D							.004-.006		.006-.008		.008-.010		.008-.010	.010-.012		
60-200	1 x D							.002-.004		.002-.006		.002-.006		.004-.008			
62-700	1 x D			.002-.004		.004-.006		.006-.010		.006-.010		.010-.012					
62-750	1 x D			.002-.004		.004-.006		.006-.010		.006-.010		.010-.012					
62-800	1 x D			.002-.004		.004-.006		.006-.010		.006-.010		.010-.012					
62-850	1 x D			.002-.004		.004-.006		.006-.010		.006-.010		.010-.012					
63-700	1 x D	.002-.003		.002-.004		.004-.006		.006-.010		.006-.010		.010-.012					
63-750	1 x D	.002-.003		.002-.004		.004-.006		.006-.010		.006-.010		.010-.012					
63-800	1 x D	.002-.003		.002-.004		.004-.006		.006-.010		.006-.010		.010-.012					
63-850	1 x D	.002-.003		.002-.004		.004-.006		.006-.010		.006-.010		.010-.012					
64-000/ 65-000	1 x D	.002-.004		.006-.008		.008-.010	.010-.012	.010-.012		.010-.012							
66-000	1 x D							.002-.004		.003-.005		.004-.006					

**FORMULAS:** Chip Load = Feed Rate / (RPM x # of cutting edges)  
 Feed Rate (IPM) = RPM x # of cutting edges x chip load  
 Speed (RPM) = Feed Rate / (# of cutting edges x chip load)

**DEFINITIONS:** IPM = Inches Per Minute

# D Drill Cutting Data Recommendations

Recommended Chip Load per Tooth by Cutting Diameter (in)																	
Series		SFM	3	1/8	3/16	5	6	1/4	5/16	8	3/8	7/16	1/2	5/8	3/4	7/8	1
67-800	Composites	230		.001-.003	.001-.003			.002-.004	.002-.004		.003-.005	.003-.005	.003-.005				
68-900	Composites	230		.001				.0015			.0015		.0015				
70-500	Plastic	200		.019-.021				.021-.023			.023-.025		.025-.027				
72-000*	Wood		.009-.011			.011-.013	.013-.015			.015-.017							
85-800	Composites	230		.0005	.0005			.001	.001		.0015		.001				
86-150	Composites	150-250		.001	.001			.0015			.0015		.0015				

\* Gang drills run at 4,500 RPM and 150 IPM

**FORMULAS:** RPM = (3.82 x SFM) / tool dia.  
 Feedrate (IPM) = RPM x IPR

**DEFINITIONS:**  
 IPM = Inches Per Minute  
 IPR = Inches Per Revolution

# F Foam Cutting Data Recommendations

**DEPTH OF CUT:** 1 x D Use recommended chip load  
 2 x D Reduce chip load by 25%  
 3 x D Reduce chip load by 50%

Recommended Chip Load per Tooth by Cutting Diameter (in)																							
Series	Cut	1/16	3/32	1/8	5/32	3/16	7/32	1/4	5/16	3/8	7/16	1/2	9/16	5/8	3/4	7/8	1	1 1/8	1 1/4	1 1/2	1 3/4	2	
40-550	1 x D											.004-.006											
48-000	1 x D			.002-.004		.002-.004		.003-.005	.003-.005	.004-.006		.005-.007		.006-.008	.007-.009		.010						
52-550	1 x D			.002-.004		.002-.004		.004-.006	.004-.006	.004-.006		.005-.007		.006-.008	.007-.009		.010						
52-700	1 x D			.002-.004		.002-.004		.004-.006	.004-.006	.004-.006		.005-.007		.006-.008	.007-.009		.010						
56-000P	1 x D			.002-.004		.002-.004		.004-.006		.004-.006		.005-.007											
77-100	1 x D			.002-.004				.004-.006															

29-000	HONEYCOMB CORE	ALUMINUM		NOMEX		PAPER	
	Part #	RPM	Feed Rate	RPM	Feed Rate	RPM	Feed Rate
	29-003 (1/4")	500-4,000	100 IPM	500-10,000	120 IPM	500-10,000	120 IPM
	29-006 (3/8")	500-4,000	100 IPM	500-10,000	120 IPM	500-10,000	120 IPM
	29-009 (1/2")	500-4,000	100 IPM	500-10,000	120 IPM	500-10,000	120 IPM
	29-012 (5/8")	500-4,000	100 IPM	500-10,000	120 IPM	500-10,000	120 IPM
	29-015 (3/4")	500-4,000	100 IPM	500-10,000	120 IPM	500-10,000	120 IPM

29-050	SPINDLE SPEED		CORE TYPE	Max Feed Rate	SPINDLE SPEED		29-100
	DIA	Max RPM			Feed Rate	Max RPM	
	1/4	25,000	NR	Aluminum, less than 5#/cuft	100	25,000	1/4
	3/8	25,000	NR	Aluminum, more than 5#/cuft	100	25,000	3/8
	1/2	25,000	800	Paper based	400	25,000	1/2
	3/4	25,000	800	Paper based w/Fiber Reinforcement	800	25,000	3/4
	1	25,000	800	Fiberglass	600		
	1-1/2	18,000	800	Phenolic	600		
	1-3/4	18,000	NR	Carbon Fiber	800		
	2	16,500	100	Aramid, less than 5#/cuft	800		
	2-1/2	15,000	100	Aramid, more than 5#/cuft	800		
	3	14,000					
	4	12,000					

30-000/ 30-300 30-700 32-200	SPEEDS & FEEDS	FEED RATES				SPINDLE SPEED	
	Core Type	Solid Carbide	Solid Carbide w/Teeth	Diamond Saw	HSS	DIA	MAX RPM
	Aluminum, less than 5#/cuft	100	100	NR	150	1/4	25,000
	Aluminum, more than 5#/cuft	100	100	NR	100	3/8	25,000
	Paper based	400	400	NR	250	1/2	25,000
	Paper based with Fiber Reinforcement	800	800	400	150	3/4	25,000
	Fiberglass	600	600	600	NR	1	25,000
	Phenolic	200	200	400	NR	1-1/2	18,000
	Carbon Fiber	NR	NR	800	NR	1-3/4	18,000
	Aramid, less than 5#/cuft	800	800	400	150	2	16,500
	Aramid, more than 5#/cuft	800	800	400	NR	2-1/2	15,000
						3	14,000
						4	12,000

Note: 30-300 assembly requires one (1) hogger and one (1) blade

31-000/ 32-000	SPEEDS & FEEDS	FEED RATES						SPINDLE SPEED	
	Core Type	Solid Carbide	Diamond Carbide	HSS Saw	HSS Wavy	HSS (31-000)	HSS (31-100)	DIA	MAX RPM
	Aluminum, less than 5#/cuft	100	NR	150	100	100-140	90-140	3/8	25,000
	Aluminum, more than 5#/cuft	100	NR	100	100	70	70	1/2	25,000
	Paper based	300	NR	200	300	50	50	3/4	25,000
	Paper based w/Fiber Reinforcement	400	300	600	300	100-150	100-150	1	25,000
	Fiberglass	NR	600	NR	NR	NR	NR	1-1/2	25,000
	Phenolic	NR	600	NR	NR	NR	NR	1-3/4	25,000
	Carbon Fiber	NR	800	NR	NR	NR	NR	2	18,000
	Aramid, less than 5#/cuft	200	NR	150	200	100-150	100-150	2-1/2	18,000
	Aramid, more than 5#/cuft	200	400	NR	NR	NR	NR	3	18,000

34-000	CORE TYPE	CUTTER	RPM	FEED RATE	CUT DIRECTION
	Fiberglass panels with paper core (Nomex®)	Diamond Grit	18,000	220 lpm	Conventional
	Aluminum panels with aluminum core	HSS Saw	16,000	120 lpm	Conventional

# CP Composite Cutting Data Recommendations

APPLICATION	GOOD	BETTER	BEST
Carbon Fiber Reinforced Plastic (CFRP)-Finishing	N/A	66-700	68-000
Carbon Fiber Reinforced Plastic (CFRP)-Semi Finishing	66-900	66-775	68-200
Carbon Fiber Reinforced Plastic (CFRP)-Roughing	66-900	66-500	68-300
Glass Fiber Reinforced Plastic (GFRP)-Finishing	54-200	66-700	68-000
Glass Fiber Reinforced Plastic (GFRP)-Semi Finishing	54-200	66-775	68-200
Glass Fiber Reinforced Plastic (GFRP)-Roughing	66-900	66-500	68-300
Phenolic-Finishing	67-200	54-200	68-000
Phenolic-Semi Finishing	67-200	67-255	67-220
Phenolic-Roughing	67-200	66-500	68-200
Kevlar-Finishing	N/A	N/A	68-000
Speciality-Edge Finish		66-800	
Speciality-Contouring		68-400	

**DEPTH OF CUT:**

- 1 x D Use recommended chip load
- 2 x D Reduce chip load by 25%
- 3 x D Reduce chip load by 50%

Recommended Chip Load per Tooth by Cutting Diameter (in)																							
Series	Cut	1/16	3/32	1/8	5/32	3/16	7/32	1/4	5/16	3/8	7/16	1/2	9/16	5/8	3/4	7/8	1	1 1/8	1 1/4	1 1/2	1 3/4	2	
54-200	1 x D			.002-.004		.002-.004		.002-.004		.003-.006		.005-.010											
56-000P	1 x D			.002-.004		.002-.004		.004-.006		.004-.006		.004-.006											
56-450	1 x D					.002-.005		.003-.005	.003-.006	.004-.006		.005-.007											
57-000	1 x D			.003-.005		.003-.005		.004-.006		.006-.008		.010-.012											
63-000	1 x D			.003-.005		.003-.005		.003-.005	.004-.006			.005-.007											
66-500	See page 127 for technical data																						
66-700	See page 127 for technical data																						
66-750	See page 127 for technical data																						
66-775	See page 127 for technical data																						
66-800	See page 127 for technical data																						
66-900	1 x D			.002-.004		.002-.004		.004-.006		.004-.006		.006-.008											
67-000	1 x D							.004-.006		.004-.006		.004-.006											
67-200	1 x D									.002-.010		.002-.010											
67-220*	1 x D									.001-.002		.001-.002											
67-250	1 x D			.002-.004				.004-.006		.004-.006													
67-400	1 x D			.002-.004				.004-.006		.004-.006		.004-.006											
67-500	1 x D			.001-.003		.001-.003		.002-.004	.002-.004	.003-.005		.004-.006											
68-000*	See page 128 for technical data																						
68-200*	See page 129 for technical data																						
68-300*	See page 129 for technical data																						
68-400	See page 129 for technical data																						

**NOTE:** \*Spindle RPM's generally range from 12,000-16,000 for PCD tools when cutting composite materials.

Consider 66-500, 66-900, 67-000, 67-250, 67-500 series tools as a single flute in speed & feed rate calculations.

**FORMULAS:** Chip Load = Feed Rate / (RPM x # of cutting edges)  
 Feed Rate (IPM) = RPM x # of cutting edges x chip load  
 Speed (RPM) = Feed Rate / (# of cutting edges x chip load)

**DEFINITIONS:** IPM = Inches Per Minute

RECOMMENDED STARTING	
DIA	RPM
1/8-3/16	10,000-12,000
1/4	8,000-10,000
3/8	6,000-8,000
1/2	4,000-6,000

CP

# 66-500/66-700/66-750 66-775/66-800 Series Cutting Data Recommendations

ISO Grade	Material	Application	Recommended Starting Parameters										
			Rad DOC	Axial DOC	SFM Range	Chip Load Per Tooth							
						SFM Starting 1/8	1/8	SFM Starting 1/4	1/4	SFM Starting 3/8	3/8	SFM Starting 1/2	1/2
<b>66-500 DFC Multi Flute</b>													
O	CFRP	Full Slotting	1 x DIA	.50 x DIA	450/ 1600	450	0.0015	850	0.0026	1200	0.0035	1600	0.0045
		Heavy Profile	.33 x DIA	1.25 x DIA		450	0.0022	850	0.0035	1200	0.0045	1600	0.0055
		HEM* Profile	.15 x DIA	2 x DIA		450	0.0030	850	0.0050	1200	0.0060	1600	0.0065
		Finishing	.05 x DIA	2 x DIA		450	0.0025	850	0.0035	1200	0.0045	1600	0.0550
	GFRP	Full Slotting	1 x DIA	.50 x DIA	275/ 1000	275	0.0020	500	0.0030	750	0.0040	1000	0.0050
		Heavy Profile	.33 x DIA	1.25 x DIA		275	0.0030	500	0.0035	750	0.0055	1000	0.0065
		HEM* Profile	.15 x DIA	2 x DIA		275	0.0045	500	0.0052	750	0.0080	1000	0.0095
		Finishing	.05 x DIA	2 x DIA		275	0.0035	500	0.0045	750	0.0062	1000	0.0068
	Phenolic	Full Slotting	1 x DIA	.50 x DIA	325/ 1400	325	0.0015	700	0.0026	1000	0.0035	1400	0.0045
		Heavy Profile	.33 x DIA	1.25 x DIA		325	0.0022	700	0.0035	1000	0.0045	1400	0.0055
		HEM* Profile	.15 x DIA	2 x DIA		325	0.0030	700	0.0050	1000	0.0060	1400	0.0065
		Finishing	.05 x DIA	2 x DIA		325	0.0025	700	0.0035	1000	0.0045	1400	0.0550
<b>66-700 DFC Low-Helix Finisher Upcut</b>													
O	CFRP	Finishing	.05 x DIA	2 x DIA	450/1000	-	-	1000	0.0008	1000	0.0010	1000	0.0015
	GFRP	Finishing	.05 x DIA	2 x DIA	450/1000	-	-	450	0.0015	450	0.0020	450	0.0030
	Phenolic	Finishing	.05 x DIA	2 x DIA	450/1000	-	-	650	0.0011	650	0.0023	650	0.0025
<b>66-750 DFC Low-Helix Cutter</b>													
O	CFRP	Full Slotting	1 x DIA	.5 x DIA	500/ 1600	-	-	850	0.001	1200	0.001	1600	0.0008
		Heavy Profile	.33 x DIA	1.25 x DIA		-	-	850	0.001	1200	0.001	1600	0.0012
		HEM* Profile	.15 x DIA	2 x DIA		-	-	850	0.001	1200	0.001	1600	0.0016
		Finishing	.05 x DIA	2 x DIA		-	-	850	0.001	1200	0.001	1600	0.0014
	GFRP	Full Slotting	1 x DIA	.5 x DIA	500/ 1500	-	-	500	0.001	750	0.002	1000	0.0018
		Heavy Profile	.33 x DIA	1.25 x DIA		-	-	500	0.001	750	0.002	1000	0.0022
		HEM* Profile	.15 x DIA	2 x DIA		-	-	500	0.002	750	0.002	1000	0.0026
		Finishing	.05 x DIA	2 x DIA		-	-	500	0.002	750	0.002	1000	0.0024
	Phenolic	Full Slotting	1 x DIA	.5 x DIA	500/ 1200	-	-	700	0.001	1000	0.001	1400	0.0008
		Heavy Profile	.33 x DIA	1.25 x DIA		-	-	700	0.001	1000	0.001	1400	0.0012
		HEM* Profile	.15 x DIA	2 x DIA		-	-	700	0.001	1000	0.001	1400	0.0016
		Finishing	.05 x DIA	2 x DIA		-	-	700	0.001	1000	0.001	1400	0.0014
<b>66-775 DFC Low-Helix Rougher-Finisher-Upcut</b>													
O	CFRP	Full Slotting	1 x DIA	1 x DIA	500/ 2000	-	-	850	0.0005	1200	0.0006	1600	0.00080
		Heavy Profile	.33 x DIA	1.25 x DIA		-	-	850	0.0008	1200	0.0010	1600	0.00120
		HEM* Profile	.15 x DIA	2 x DIA		-	-	850	0.0013	1200	0.0014	1600	0.00160
		Finishing	.06 x DIA	2 x DIA		-	-	850	0.0011	1200	0.0012	1600	0.00140
	GFRP	Full Slotting	1 x DIA	1 x DIA	500/ 2000	-	-	500	0.0010	750	0.0015	1000	0.00180
		Heavy Profile	.33 x DIA	1.25 x DIA		-	-	500	0.0014	750	0.0019	1000	0.00220
		HEM* Profile	.15 x DIA	2 x DIA		-	-	500	0.0019	750	0.0023	1000	0.00260
		Finishing	.06 x DIA	2 x DIA		-	-	500	0.0015	750	0.0016	1000	0.00240
	Phenolic	Full Slotting	1 x DIA	1 x DIA	300/ 2000	-	-	700	0.0005	1000	0.0006	1400	0.00080
		Heavy Profile	.33 x DIA	1.25 x DIA		-	-	700	0.0008	1000	0.0010	1400	0.00120
		HEM* Profile	.15 x DIA	2 x DIA		-	-	700	0.0013	1000	0.0014	1400	0.00160
		Finishing	.06 x DIA	2 x DIA		-	-	700	0.0011	1000	0.0012	1400	0.00140
<b>66-800 DFC Compression</b>													
O	CFRP	Full Slotting	1 x DIA	1 x DIA	500/ 1600	-	-	850	0.0008	1200	0.0010	1600	0.0012
		Heavy Profile	.33 x DIA	1.25 x DIA		-	-	850	0.0010	1200	0.0012	1600	0.0014
		HEM* Profile	.15 x DIA	2 x DIA		-	-	850	0.0015	1200	0.0016	1600	0.0018
		Finishing	.06 x DIA	2 x DIA		-	-	850	0.0014	1200	0.0013	1600	0.0015

# PCD Cutting Data Recommendations

ISO Grade	Material	Application	Recommended Starting Parameters										
			Rad DOC	Axial DOC	SFM Range	SFM Starting	Chip Load Per Tooth						
							1/8	1/4	3/8	1/2	5/8	3/4	1
<b>67-220-PCD Progressive Chipbreakers</b>													
O	CFRP	Full Slotting	1 X DIA	.5 x DIA	750/1250	800	-	-	0.0010	0.0015	-	-	-
		Heavy Profile	.33 x DIA	1 x DIA		800	-	-	0.0015	0.0020	-	-	-
		HEM* Profile	.15 x DIA	1 x DIA		900	-	-	0.0020	0.0030	-	-	-
		Finishing	.05 x DIA	1 x DIA		1100	-	-	0.0020	0.0030	-	-	-
	GFRP	Full Slotting	1 X DIA	.5 X DIA	500/750	500	-	-	0.0010	0.0015	-	-	-
		Heavy Profile	.33 x DIA	.75 x DIA		500	-	-	0.0015	0.0025	-	-	-
		HEM* Profile	.15 x DIA	1 x DIA		600	-	-	0.0020	0.0030	-	-	-
		Finishing	.05 x DIA	1 x DIA		700	-	-	0.0020	0.0030	-	-	-
	Phenolic	Full Slotting	1 X DIA	.5 x DIA	750/1500	800	-	-	0.0010	0.0015	-	-	-
		Heavy Profile	.33 x DIA	1 x DIA		800	-	-	0.0015	0.0025	-	-	-
		HEM* Profile	.15 x DIA	1 x DIA		900	-	-	0.0020	0.0030	-	-	-
		Finishing	.05 x DIA	1 x DIA		1100	-	-	0.0020	0.0030	-	-	-

ISO Grade	Material	Application	Recommended Starting Parameters										
			Rad DOC	Axial DOC	SFM Range	SFM Starting	Chip Load Per Tooth						
							1/8	1/4	3/8	1/2	5/8	3/4	1
<b>68-000 PCD Tipped Tools</b>													
O	CFRP	Full Slotting	1 X DIA	.5 x DIA	500/1000	800	-	0.0010	0.0015	0.0020	-	0.0030	-
		Heavy Profile	.33 x DIA	1 x DIA		800	-	0.0015	0.0020	0.0025	-	0.0035	-
		HEM* Profile	.15 x DIA	1 x DIA		800	-	0.0020	0.0025	0.0030	-	0.0040	-
		Finishing	.05 x DIA	1 x DIA		800	-	0.0010	0.0020	0.0030	-	0.0040	-
	GFRP	Full Slotting	1 X DIA	.5 x DIA	375/625	400	-	0.0010	0.0015	0.0020	-	0.0030	-
		Heavy Profile	.33 x DIA	1 x DIA		400	-	0.0015	0.0020	0.0025	-	0.0035	-
		HEM* Profile	.15 x DIA	1 x DIA		400	-	0.0020	0.0025	0.0030	-	0.0040	-
		Finishing	.05 x DIA	1 x DIA		400	-	0.0010	0.0020	0.0030	-	0.0040	-
	Phenolic	Full Slotting	1 X DIA	.5 x DIA	500/1000	500	-	0.0010	0.0015	0.0020	-	0.0030	-
		Heavy Profile	.33 x DIA	1 x DIA		500	-	0.0015	0.0020	0.0030	-	0.0040	-
		HEM* Profile	.15 x DIA	1 x DIA		600	-	0.0015	0.0020	0.0030	-	0.0040	-
		Finishing	.05 x DIA	1 x DIA		800	-	0.0020	0.0030	0.0040	-	0.0040	-

ISO Grade	Material	Application	Recommended Starting Parameters										
			Rad DOC	Axial DOC	SFM Range	SFM Starting	Chip Load Per Tooth						
							1/8	1/4	3/8	1/2	5/8	3/4	1
<b>68-200-PCD SERF Cutter</b>													
O	CFRP	Full Slotting	1 x DIA	1 x DIA	750/1250	800	-	0.0010	0.0015	0.0020	-	-	-
		Heavy Profile	.33 x DIA	1 x DIA		1000	-	0.0020	0.0030	0.0040	-	-	-
		HEM* Profile	.15 x DIA	1.5 x DIA		1000	-	0.0030	0.0040	0.0050	-	-	-
	GFRP	Full Slotting	1 x DIA	.5 x DIA	500/750	500	-	0.0010	0.0015	0.0020	-	-	-
		Heavy Profile	.33 x DIA	.75 x DIA		600	-	0.0020	0.0030	0.0040	-	-	-
		HEM* Profile	.15 x DIA	1 x DIA		600	-	0.0020	0.0030	0.0040	-	-	-
	Phenolic	Full Slotting	1 x DIA	1 x DIA	750/1500	800	-	0.0010	0.0015	0.0020	-	-	-
		Heavy Profile	.33 x DIA	1 x DIA		1000	-	0.0020	0.0030	0.0040	-	-	-
		HEM* Profile	.15 x DIA	1.5 x DIA		1200	-	0.0020	0.0030	0.0040	-	-	-



PCD

# PCD Cutting Data Recommendations

ISO Grade	Material	Application	Recommended Starting Parameters										
			Rad DOC	Axial DOC	SFM Range	SFM Starting	Chip Load Per Tooth						
							1/8	1/4	3/8	1/2	5/8	3/4	1
<b>68-300-PCD SERFIN Cutter</b>													
O	CFRP	Full Slotting	1 x DIA	.5 x DIA	750/1250	800	-	-	0.0015	0.0020		0.0025	-
		Heavy Profile	.33 x DIA	1 x DIA		1000	-	-	0.0020	0.0025		0.0035	-
		HEM* Profile	.15 x DIA	1 x DIA		1000	-	-	0.0030	0.0030		0.0040	-
		Finishing	.05 x DIA	1 x DIA		1000	-	-	0.0020	0.0025		0.0035	-
	GFRP	Full Slotting	1 x DIA	.5 x DIA	500/750	500	-	-	0.0015	0.0020		0.0030	-
		Heavy Profile	.33 x DIA	.5 x DIA		500	-	-	0.0020	0.0030		0.0040	-
		HEM* Profile	.15 x DIA	1 x DIA		500	-	-	0.0020	0.0030		0.0040	-
		Finishing	.05 x DIA	1 x DIA		600	-	-	0.0020	0.0030		0.0040	-
	Phenolic	Full Slotting	1 x DIA	.5 x DIA	750/1500	800	-	-	0.0010	0.0020		0.0020	-
		Heavy Profile	.33 x DIA	1 x DIA		1000	-	-	0.0020	0.0030		0.0040	-
		HEM* Profile	.15 x DIA	1 x DIA		1200	-	-	0.0020	0.0030		0.0040	-
		Finishing	.05 x DIA	1 x DIA		1200	-	-	0.0020	0.0030		0.0040	-

ISO Grade	Material	Application	Recommended Starting Parameters										
			Rad DOC	Axial DOC	SFM Range	SFM Starting	Chip Load Per Tooth						
							1/8	1/4	3/8	1/2	5/8	3/4	1
<b>68-400-PCD Ballnose</b>													
O	CFRP	Heavy Profile	.25 - .5 x DIA	.5 x DIA	750/1000	800	-	0.0005	0.0010	0.0015	0.0017	0.0020	-
		-	-	-		-	-	-	-	-	-	-	
		Finishing	.05 x DIA	.05 x DIA		900	-	0.0020	0.0030	0.0035	0.0040	0.0045	-
	GFRP	Heavy Profile	.25 - .5 x DIA	.5 x DIA	350/600	375	-	0.0010	0.0020	0.0030	0.0035	0.0040	-
		-	-	-		-	-	-	-	-	-	-	
		Finishing	.05 x DIA	.05 x DIA		500	-	0.0020	0.0030	0.0040	0.0045	0.0050	-
	Phenolic	Heavy Profile	.25 - .5 x DIA	.5 x DIA	500/750	600	-	0.0010	0.0020	0.0030	0.0035	0.0040	-
		-	-	-		-	-	-	-	-	-	-	
		Finishing	.05 x DIA	.05 x DIA		700	-	0.0020	0.0030	0.0040	0.0045	0.0050	-

RPM
(3.82 x SFM) / tool diameter

SFM
RPM x .262 x tool diameter

FEED RATE (in / min)
chipload x # flutes x RPM

Feed / Tooth (in)
Feed Rate / (RPM x # Flutes)

Customer Information			
Company		Street	
End User		City / Zip Code	
Name		Date	
E-Mail		Contact	

Tool Material	
<input type="checkbox"/> HSS	<input type="checkbox"/> PCD Full Face
<input type="checkbox"/> Solid Carbide	<input type="checkbox"/> PCD
<input type="checkbox"/> Carbide Tip	<input type="checkbox"/> Powder Material
<input type="checkbox"/> Other _____	

Flute Style	
<input type="checkbox"/> Up	<input type="checkbox"/> Straight
<input type="checkbox"/> Down	<input type="checkbox"/> Compression

Flute Form	
<input type="checkbox"/> Rougher	<input type="checkbox"/> Finisher
<input type="checkbox"/> Chipbrk/Finisher	<input type="checkbox"/> Burr
<input type="checkbox"/> Other _____	

Point Geometry	
<input type="checkbox"/> Square	<input type="checkbox"/> Non-Center Cutting
<input type="checkbox"/> Center Cutting	<input type="checkbox"/> Ball Nose
<input type="checkbox"/> Other _____	

Tool Data	
Tool similar to	
Number of Flutes	
Coating	<input type="checkbox"/> ESG
	<input type="checkbox"/> ESR
	<input type="checkbox"/> ZRN
	<input type="checkbox"/> TiN
	<input type="checkbox"/> MAR
	<input type="checkbox"/> PLR
	<input type="checkbox"/> Uncoated
<input type="checkbox"/> Other _____	
Flat	<input type="checkbox"/> Weldon
	<input type="checkbox"/> Whistle Notch
	<input type="checkbox"/> Other _____

Machine & Material Information	
Machine Type	<input type="checkbox"/> CNC Router <input type="checkbox"/> Air Router <input type="checkbox"/> Hand Router
Material Being Machined	

Dimensions	
<p>The diagram shows a side view of a double-flute drill bit. Dimension lines indicate the following measurements: <math>l_3</math> (total length), <math>l_2</math> (length to the start of the second flute), <math>d_1</math> (outer diameter), <math>d_2</math> (inner diameter), <math>d_3</math> (flute depth), and <math>l_1</math> (length to the end of the second flute).</p>	
Corner Radius	

Quantity & Pricing	
Quantity Needed <b>(Minimum of 6 pieces)</b>	
Target Pricing?	<input type="checkbox"/> Distributor <input type="checkbox"/> End User

Notes

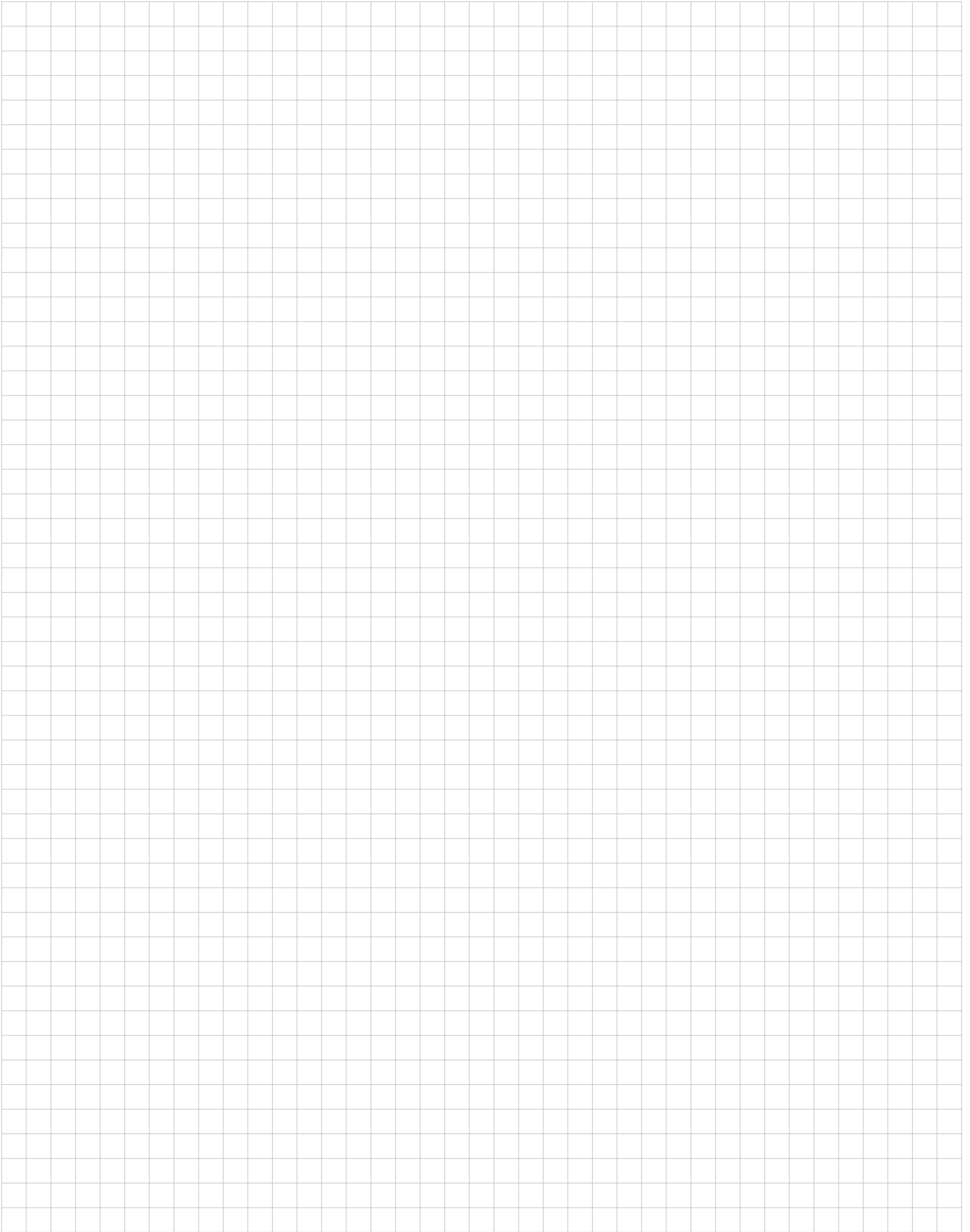



**LMT Onsrud LP**

1081 S. Northpoint Blvd.  
Waukegan, IL 60085  
Phone +1 847 362 1560  
Fax +1 847 473 1934  
[info@onsrud.com](mailto:info@onsrud.com)  
[www.onsrud.com](http://www.onsrud.com)  
PCT-19