

LMT Tools Fräsen
Werkzeuge und Wissen
LMT Tools Milling
Tools and Knowledge



Vorwort Foreword

Sehr geehrte Kunden und Interessenten,

wer im Wettbewerb bestehen will, muss ebenso effizient wie flexibel auf rasch wechselnde Anforderungen reagieren können. Daher ist es umso wichtiger auf einen zuverlässigen Werkzeuglieferanten setzen zu können. Die LMT Tools bietet Ihnen ein umfangreiches Produktprogramm an Standard- oder Sonderwerkzeugen.

Mit diesem Spezialkatalog „LMT Tools Fräsen – Werkzeuge und Wissen“ setzen wir unser erfolgreiches Katalogkonzept fort und haben darin unsere gesamte Kompetenz für diese Anwendung gebündelt. Der Katalog bietet Ihnen Präzisionswerkzeuge von LMT Fette, LMT Kieninger und LMT Onsrud, vom Schafffräser oder Frässystem mit Wendepplatten bis hin zum Zubehör.

Wiederaufbereitung in Herstellerqualität

Mit unserem Wiederaufbereitungsservice bieten wir Ihnen zudem den entscheidenden Vorteil um Ihre Neuwerkzeugkosten zu senken. Modernste Maschinen und Kompetenz aus unserem Haus garantieren die fachgerechte Aufbereitung in Herstellerqualität.

Auf eine produktive Zusammenarbeit.

Ihre LMT Tool Systems

Dear customers and potential customers,

to stay ahead of the competition it is important to react both, efficiently and flexibly to quickly changing requirements. This makes it even more important to have a reliable tool supplier. LMT Tools offers you an extensive product range of standard and special tools.

With this special catalog “LMT Tools Milling – Tools and Knowledge”, we bundle our complete competence for this application and continue our successful catalog concept. The catalog offers you the precision tools of LMT Fette, LMT Kieninger and LMT Onsrud, from end mills or milling systems with indexable inserts and accessories.

Reconditioning to the manufacturer's original specifications

In addition, our reconditioning service offers you the decisive advantage to reduce your costs for new tools. State-of-the-art machines and competence from LMT Tools guarantees professional reconditioning to the manufacturer's original specifications.

We look forward to a productive cooperation.

LMT Tool Systems



NEW

www.shop.lmt-tools.de

Der LMT Tools Online-Shop!

Für Kunden aus Deutschland bieten wir unser Standard-Produktprogramm nun auch in unserem neuen Online-Shop an. Nutzen Sie die speziellen Vorteile und bestellen Sie Ihre Produkte bequem im LMT Tools Online-Shop. Registrieren Sie sich noch heute!

© by LMT Tool Systems GmbH

Nachdruck, auch auszugsweise, ist nur mit unserer Zustimmung gestattet. Alle Rechte vorbehalten. Irrtümer, Satz- oder Druckfehler berechtigen nicht zu irgendwelchen Ansprüchen. Abbildungen, Ausführungen und Maße entsprechen dem neuesten Stand bei Herausgabe dieses Kataloges. Technische Änderungen müssen vorbehalten sein.

Die bildliche Darstellung der Produkte muss nicht in jedem Falle und in allen Einzelheiten dem tatsächlichen Aussehen entsprechen.

Bildquellen: Nataliya Hora, adimas, Alterfalter, Rudy Balasko, Fotolia; zhu difeng, Shutterstock; Keyzo, Berlin; studio thomas schmitz, Hamburg; Dominik Obertreis, Waldenweiler; Firma Work NC-Dental®; Maschinenbau GmbH, Bleckede; LMT GmbH & Co. KG

This publication may not be reprinted in whole or part without our express permission. All right reserved. No rights may be derived from any errors in content or from typographical or typesetting errors. Diagrams, features and dimensions represent the current status on the date of issue of this catalog. We reserve the right to make technical changes.

The visual appearance of the products may not necessarily correspond to the actual appearance in all cases or in every detail.

Sources: Nataliya Hora, adimas, Alterfalter, Rudy Balasko, Fotolia; zhu difeng, Shutterstock; Keyzo, Berlin; studio thomas schmitz, Hamburg; Dominik Obertreis, Waldenweiler; Firma Work NC-Dental®; Maschinenbau GmbH, Bleckede; LMT GmbH & Co. KG

2	Das Unternehmen The company
3	Die LMT Tools Gruppe – Das Expertenteam The LMT Tools Group – Team of experts
6	Der LMT Werkzeugservice The LMT tool service
7	eboy® – LMT Dienstleistungen eboy® – LMT services
8	Die LMT Group Academy The LMT Group Academy
9	Werkzeug-Highlights an ausgewählten Bauteilen Tool solutions on selected components

Fräsen mit Schafffräsern aus Vollhartmetall

Milling with solid carbide end mills



Fräsen mit HSS-E-PM, HSS-E

Milling with HSS-E-PM, HSS-E



Fräsen mit Wendeschneidplatten

Milling with indexable inserts

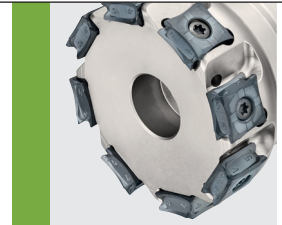

Wendeschneidplatten

Indexable inserts

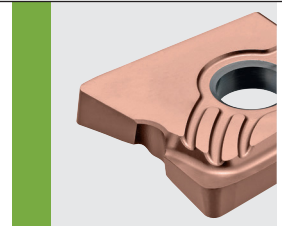

Technischer Anhang

Technical appendix

Ersatzteile
Spare parts

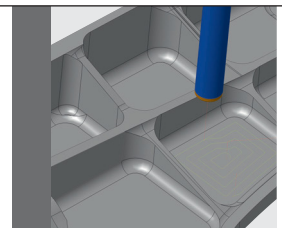

exactly
yours

LMT Tools bündelt die Kompetenzen führender Spezialisten aus der Präzisionswerkzeugtechnik. Auf dieser Basis entwickelt und liefert LMT Tools weltweit Werkzeuglösungen zur Bearbeitung von hochfesten Stahlwerkstoffen bis hin zu Composite-Materialien.

Das umfangreiche Produktprogramm bietet perfekte Lösungen für die Branchen Automotive, Aerospace, Maschinenhersteller OEM, allgemeiner Maschinenbau, Gesenk- und Formenbau oder Energie und deckt nahezu alle Anwendungen ab.

LMT Tools combines the competences of leading specialists in the field of precision tool technology. This pooled expertise enables LMT Tools to develop and deliver tool solutions worldwide for processing materials ranging from high-strength steel to composite materials.

The extensive product range offers perfect solutions for the automotive, aerospace, OEM machine manufacturer, general machining, mold and die or energy and covers almost all types of applications.



Automotive
Automotive



Aerospace
Aerospace

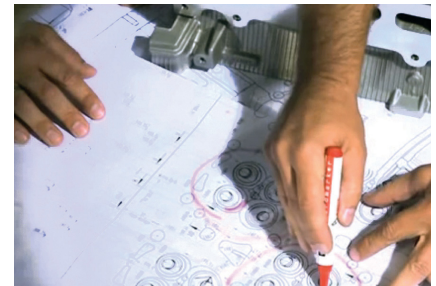

Maschinenhersteller OEM
OEM Machine manufacturer

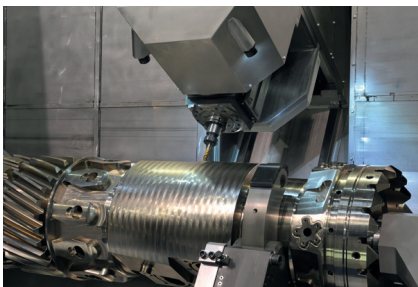

Allgemeiner Maschinenbau
General Machining

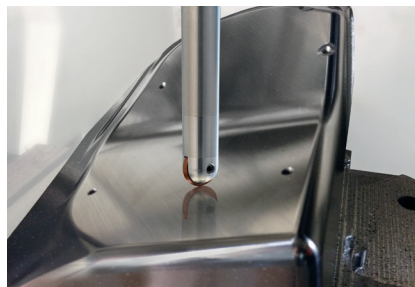

Gesenk- und Formenbau
Mold and Die



Energie
Energy

Unsere Kernkompetenzen:

- Rollen
- Verzahnen
- Gewinden
- Fräsen
- Gesenk- und Formenbau
- Advanced Tooling
- Reiben

Ergänzt wird das Produktprogramm durch spezielle Dienstleistungen wie Projektierung, Tool Management, Werkzeugausgabesysteme, Wiederaufbereitung, Kanban oder Schulungen im Rahmen des LMT Tools Training Centers – und gewährleistet damit eine Rund-um-Betreuung von Anfang an.

Our core competences:

- Rolling
- Gear cutting
- Threading
- Milling
- Mold and Die
- Advanced Tooling
- Reaming

The product range is supplemented by special services such as project engineering, tool management, tool supply systems, reconditioning, kanban or training in the context of the LMT Tools Training Centre and thus ensures all-round support from the start.

Weltweite Präsenz der LMT Tools
Worldwide presence of LMT Tools

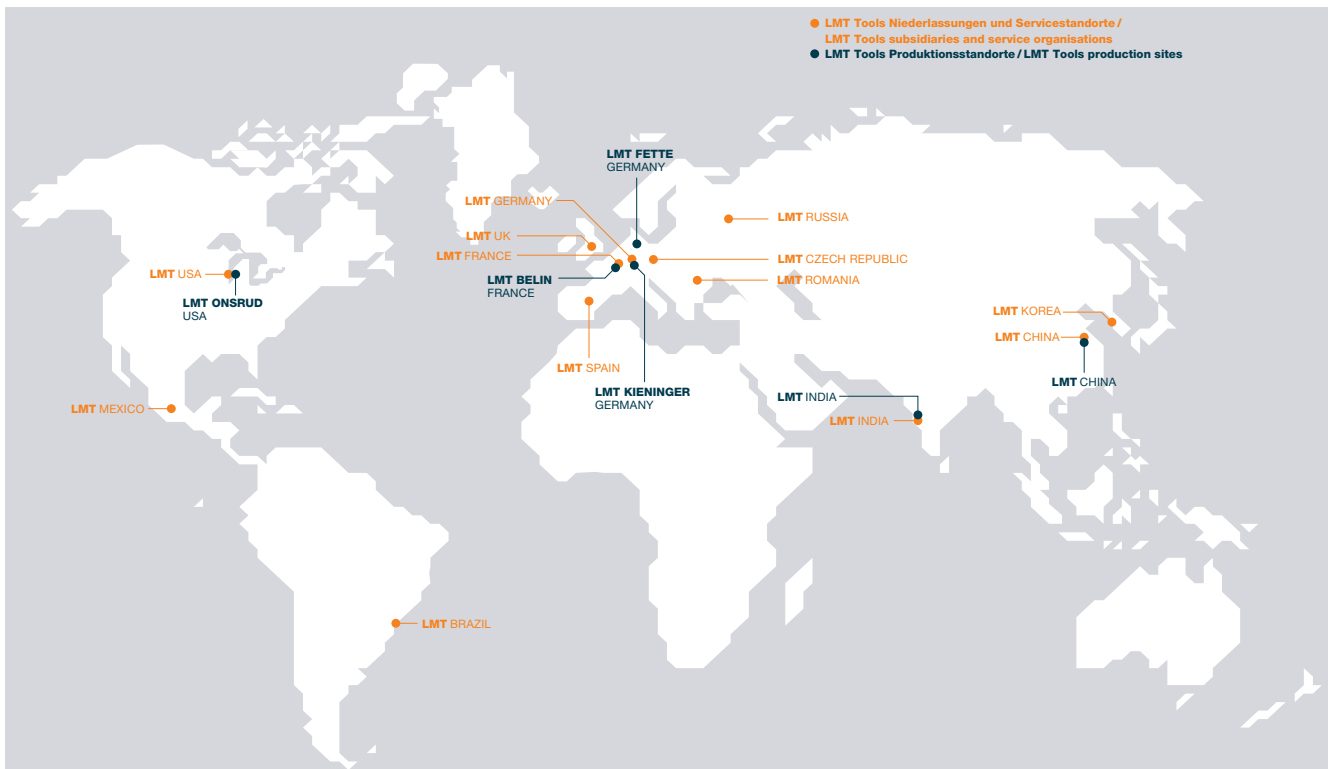

● **LMT Tools Produktionsstandorte:**

Deutschland: LMT Fette | Schwarzenbek, LMT Kieninger | Lahr
Frankreich: LMT Belin | Lavancia
USA: LMT Onsrud | Waukegan
Indien: LMT India | Pune
China: LMT China | Nanjing

● **LMT Tools production sites:**

Germany: LMT Fette | Schwarzenbek, LMT Kieninger | Lahr
France: LMT Belin | Lavancia
USA: LMT Onsrud | Waukegan
India: LMT India | Pune
China: LMT China | Nanjing

● **Die LMT Tools ist mit eigenen Vertriebsgesellschaften und Servicestandorten in folgenden Ländern vertreten:**

Europa: Deutschland, England, Frankreich, Rumänien, Russland, Spanien, Tschechische Republik.

Amerika: Brasilien, Mexiko, USA.

Asien/Australien: China, Indien, Korea.

● **LMT Tools has its own sales and service organisations in the following countries:**

Europe: Czech Republic, England, France, Germany, Romania, Russia, Spain.

America: Brazil, Mexico, USA.

Asia/Australia: China, India, Korea.

Die LMT Tools hat Vertriebspartner in folgenden Ländern:

In Europa: Belgien, Dänemark, Finnland, Israel, Italien, Kroatien, Lettland, Litauen, Niederlande, Norwegen, Polen, Portugal, Schweden, Schweiz, Slowakei, Slowenien, Türkei, Ukraine, Ungarn.

In Asien/Australien: Australien, Indonesien, Iran, Japan, Malaysia, Neuseeland, Singapur, Taiwan, Thailand, Vietnam.

In Afrika: Südafrika.

In Amerika: Argentinien.

LMT Tools has sales partners in the following countries:

In Europe: Belgium, Croatia, Denmark, Finland, Hungary, Israel, Italy, Latvia, Lithuania, Netherlands, Norway, Poland, Portugal, Slovakia, Slovenia, Sweden, Switzerland, Turkey, Ukraine.

In Asia/Australia: Australia, Indonesia, Iran, Japan, Malaysia, New Zealand, Singapore, Taiwan, Thailand, Vietnam.

In Africa: South Africa.

In America: Argentina.



Lavancia, Frankreich



Kompetenzzentrum für Reibwerkzeuge und Werkzeuge für Composites & Plastics

- Präzisions-Reibbahlen
- Hochleistungswerkzeuge für Composites & Plastics
- Projektmanagement
- Standard- und Sonderfräswerkzeuge
- Sonderwerkzeuge für die Automotive- und Aerospace-Industrie



Competence center for reaming tools and tools for composites & plastics

- High precision reamers
- High-end tools for composites & plastics
- Project management
- Standard and special form milling cutters
- Special tools for automotive and aerospace industry



Schwarzenbek, Deutschland



Kompetenzzentrum Verzahnen, Gewinden und Fräsen

- Technologieführer bei Wälzfräsen
- Innovative Beschichtungssysteme
- Komplettlösungen für den gesamten Verzahnungsprozess
- Markt- und Technologieführer bei Werkzeugen zur spanenden und spanlosen Gewindeherstellung
- Hochleistungsfräswerkzeuge



Competence center for gear cutting, threading and milling

- Technology leader in hobs
- Innovative coating systems
- Complete solutions for the entire gear cutting process
- Market and technology leader for tools for tap drilling and chipless thread forming
- Offers high-performance milling tools

Lahr, Deutschland



Kompetenzzentrum Gesenk- und Formenbau sowie Projektierung für Komponentenbearbeitung

- Frässysteme für den Gesenk- und Formenbau
- Komplettlösungen für die Gehäusebearbeitung
- Entwicklung und Fertigung von Spezialwerkzeugen



Competence center for mold and die, project engineering for component machining

- Milling systems for mold and die
- Complete solutions for component machining
- Development and manufacturing of special tools

Waukegan, USA



Kompetenzzentrum Hartmetallfräser für Composites und schwer zerspanbare Materialien

- Hartmetallfräser für die Titan- und Aluminiumbearbeitung
- Technisch führend bei Werkzeugen für Verbund- und Kunststoffe
- Spezialwerkzeuge für die Bearbeitung von Honeycomb-materialien



Competence center for solid carbide milling tools and for composites and exotic materials

- Solid carbide milling tools for the titanium and aluminium processing
- Technology leader in tools for composites and plastics
- Specialized tools for machining honeycomb materials

Wiederaufbereitung in Herstellerqualität

- Ist die Lebensdauer Ihrer Werkzeuge durch anspruchsvolle Zerspanungsaufgaben stark begrenzt?
- Möchten Sie die Wirtschaftlichkeit Ihrer Werkzeuge steigern?
- Wünschen Sie sich eine Wiederaufbereitung Ihrer Werkzeuge in Neuwerkzeugqualität vom Spezialisten?

Reconditioning to the manufacturer's original specifications

- Is the life of your tools very limited due to demanding machining tasks?
- Would you like to increase the efficiency of your tools?
- Would you like your tools reconditioned by specialists to match the quality of new tools?



Dann geben Sie Ihre Werkzeuge bei der LMT in gute Hände!

Die LMT Tools bietet Ihnen mit dem Wiederaufbereitungsservice den entscheidenden Vorteil um Ihre Neuwerkzeugkosten zu senken. Modernste Maschinen und Kompetenz aus unserem Haus garantieren die fachgerechte Aufbereitung in Herstellerqualität.

Then place your tools in LMT's safe hands!

LMT Tools Systems reconditioning service offers you the critical advantage to reduce your costs for new tools. State of the art machines and our company's expertise ensure professional reconditioning to the manufacturer's original specifications.

Unser Rundum-Dienstleistungsprogramm

- Verlängerung des Tool-Life-Cycle
- Wiederaufbereitung in Herstellerqualität
- Reduzierung des Aufwandes für Neuanschaffungen
- Hol- und Bringservice durch LMT-Außendienstmitarbeiter und LMT-Logistikpartner
- Qualifizierte Anwendungs- und Einsatzberatung

Our comprehensive service program

- Extension of the tool life cycle
- Reconditioning to the manufacturer's original specifications
- Reducing expenditure for new purchases
- Collection and return service by LMT logistics staff and LMT logistics partners
- Qualified consulting for application and use

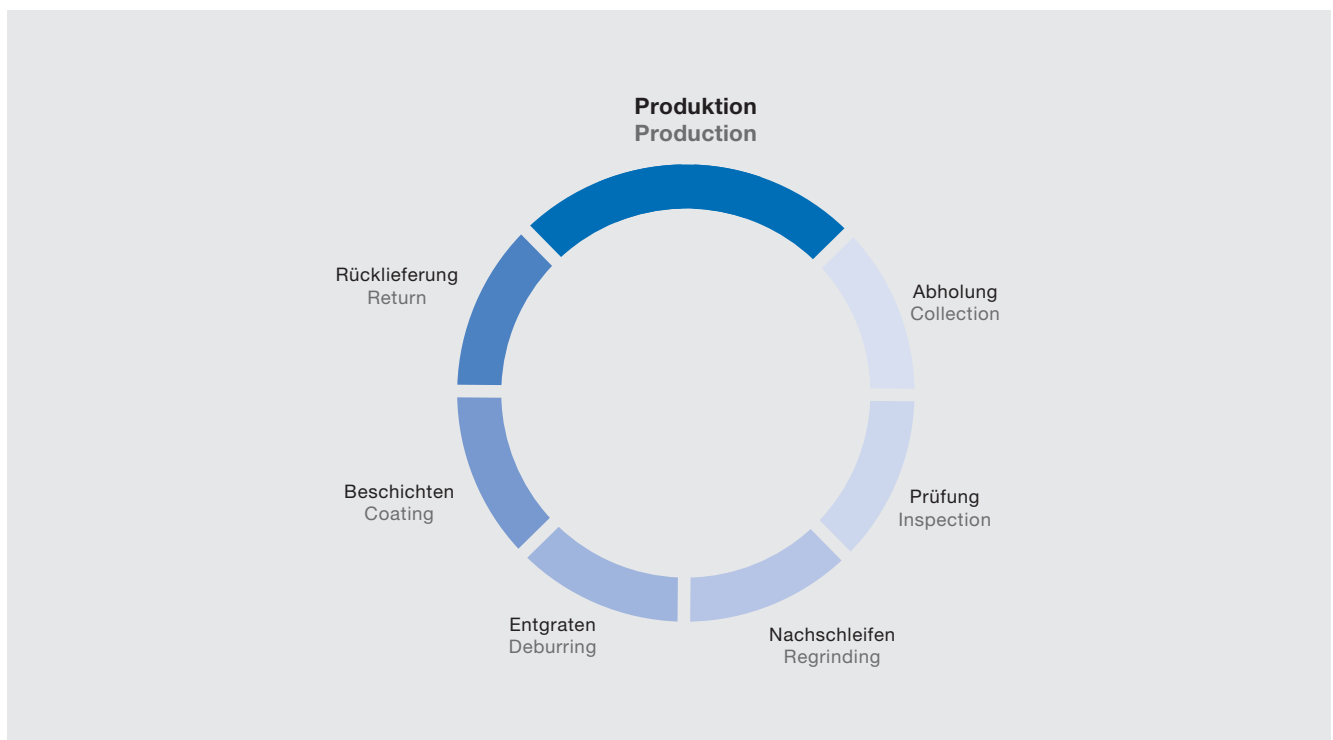

Werkzeugversorgung garantiert

Mit dem eboy® Ausgabesystem lassen sich Werkzeuglogistik und -prozesse deutlich vereinfachen. Zum einen bekommt der Bediener aus dem Automaten jederzeit das gerade benötigte Werkzeug, zum anderen funktioniert er wie ein komplettes Werkzeuglager mit integriertem Tool Management. Auf diese Weise sinken die gesamten Bereitstellungskosten der Werkzeuge deutlich.



Guaranteed tool supply

The eboy® tool dispensing system makes it possible to significantly simplify tool logistics and processes. On one hand, the operator can receive the tool he needs from the machine at any time. On the other, the dispenser functions as a kind of small tool warehouse with integrated tool management. This substantially reduces the overall cost of supplying the tools.

Sicherheit garantiert

Zugriff auf die jeweiligen Werkzeuge erhält nur derjenige Mitarbeiter, der sich durch Barcode, U-Key, Passwort oder Magnetkarte ausweist. Er wählt das Werkzeug, die benötigte Menge und entnimmt das gewünschte Werkzeug dem Ausgabefach. Zeitgleich informiert eine spezielle Software mit Online-Anbindung die Mitarbeiter in der Produktionsplanung des Tool Managers exakt über Stand und Verbrauch der Werkzeuge.

Guaranteed security

Access to each tool is restricted to the employee who can identify himself with the appropriate barcode, U-Key, password or swipe card. He selects the tool and the required amount and then removes the tool from the collection tray. Simultaneously, special software keeps production planning staff of the tool manager precisely informed of tool stocks and usage via an online connection.

LMT Experten stellen Ablauf sicher

Die notwendige Logistik im Hintergrund übernehmen die LMT Experten: Sie bestellen und liefern die Werkzeuge, befüllen den eboy® und verwalten auf Wunsch die Instandhaltung der zurückgegebenen Werkzeuge. Auf diese Weise lässt sich der Aufwand im Vergleich zur konventionellen Werkzeugbereitstellung massiv reduzieren.

LMT experts keep processes running

The tool experts of the LMT Group perform the necessary logistics in the background: they order and deliver the tools, fill the eboy® and, if desired, organize the maintenance of returned tools. Clearly, this achieves an enormous reduction in work and effort compared to conventional tool procurement.

Ihre Vorteile mit dem eboy® Ausgabesystem:

Effektivität

- 24 Stunden Verfügbarkeit
- Eigenständige Disposition
- Maximierung der Wertschöpfungszeit durch minimale Beschaffungswege

Flexibilität

- Erweiterbar auf bis zu 8 Ausgabegeräte
- Ausgabesysteme kombinierbar
- Verschiedene Maße zur Anpassung an Ihre individuelle Herausforderung

Sicherheit

- Identifizierung und Authentifizierung durch gängige Identifikationsverfahren (z. B. PIN, RFID)
- 100 % Dokumentation der Entnahmen
- Optional: Einzelklappenverriegelung für maximale Entnahmesicherheit bei den Schubladengeräten

Benutzerfreundlichkeit

- Komfortable und unkomplizierte Bedienung über Touchpanels
- Alle eboy®-Systeme arbeiten mit einer einheitlichen Software
- Variable Auswahlkriterien für Materialien

Weitere Informationen unter:

You benefits with the eboy® tool dispensing system:

Efficiency

- 24 hour availability
- Stand-alone disposition
- Increase your value-added-time by decreasing non-value-added tasks

Flexibility

- Expandable up to 8 distribution systems
- Connect different models
- Assortment of dimensions to adjust the eboy® to your individual specifications

Safety

- Identification and authorization by the use of established identification systems (e. g. PIN, RFID)
- 100 % documentation of issued tools
- Optional: single-hatch-locking for increased issue-safety

Usability

- Comfortable and easy-to-use touchpanels
- eboy® are based on one single standardized software
- Several selection criteria for tools

For more information refer to:



Der schnellste Weg zur Produktbroschüre.
Einfach scannen und mehr erfahren!

The quickest way to get the product brochure.
Simply scan the code and find out more!

Wissen in Theorie und Praxis

Produkte und Produktionsprozesse verändern sich kontinuierlich und es bedarf einer permanenten Erneuerung des technischen und des betriebswirtschaftlichen Wissens. Globale Marktveränderungen bedingen zudem neue und effektive Organisationsstrukturen sowie geeignete Vertriebs- und Managementfähigkeiten.

Auch die Kommunikationstechnik ändert sich rasant. Zur Stärkung des globalen Wissensmanagements bietet die LMT Group Academy daher verstärkt online Webseminare an, um weiter entfernten Kunden und Mitarbeitern eine zeit- und kosteneffektive Schulung zu ermöglichen.

Die LMT Group Academy leistet einen wesentlichen Beitrag zur nachhaltigen Zukunftssicherung unserer Kunden und Mitarbeiter. Sie ist die zentrale Schulungs- und Weiterbildungseinheit der Unternehmensgruppe. In ihren fachlichen Spezialbereichen wie dem LMT Tools Training Center wird das besondere Augenmerk auf die Vermittlung ganzheitlichen Wissens in der Theorie und der praktischen Anwendung gelegt.

Innerhalb zahlreicher Seminare des LMT Tools Training Centers wird dieses Wissen durch eigene Spezialisten und durch externe Experten aus Industrie und Hochschule vermittelt.

Für die LMT Group Academy gilt: Partnerschaftliche Kooperation zur Generierung einer zukunftsorientierten Performance in der Produktion.

Weiterführende Informationen zu unseren Seminaren über Rollsysteme finden Sie bitte auf unserer Website unter: <http://www.lmt-tools.de/schulungen>

Knowledge in theory and practice

Products and production processes are continuously changing. This requires a permanent renewal of technical and economic management knowledge. Moreover global market changes require new and effective organizational structures as well as suitable sales and management abilities.

Communication technologies are rapidly evolving. To strengthen the global knowledge management, the LMT Group Academy improved its offer on web based online seminars. So training becomes available in a time and cost efficient way even over long distances.

The LMT Group Academy makes a key contribution to securing a sustainable future for our customers and employees. It is the central training and education unit of the business group. In their technical fields of competence, such as the LMT Tools Training Center, particular attention is paid to conveying comprehensive knowledge in theory and practical applications.

In numerous seminars, the LMT Tools Training Center conveys this knowledge through own specialists as well as external experts coming from industry, colleges and universities.

The claim of LMT Group Academy is to generate a future-oriented performance in production through cooperating in partnership.

We invite you to explore our various seminar offers and use them frequently.

Further information about our seminars concerning rolling systems please see our website under: <http://www.lmt-tools.com/seminars>



1 SuperFinish

Maßstab für Präzision im Gesenk- und Formenbau
Dimension for precision in mould and die
(Seite Page 338)

2 EBG R/V Kopierfräser

Umfangreiches Kopierfräsprogramm, Kugel und Torisch
Comprehensive program for mold and die, ball nose and
torical
(Seite Page 340)

3 DHC Schafffräser

Schwingungsarm und multifunktional
Low vibration and multiple functions
(Seite Page 58)

4 HSCline SuperFinish

Kopierfräsen für allerhöchste Ansprüche
Copy milling for highest demands
(Seite Page 92)

5 FinishLine Premium

Hochgenaues Frässystem zum Vorschlichten und
Schlichten
High precision cutter for semifinishing and finishing
(Seite Page 315)

6 Quattro-Jet

Kopierfrässystem mit 4 Schneiden in den Geometrien
Copy milling system with 4 cutting edges in the geometries
(Seite Page 160)

HF-Hochvorschub
High feed

AF-Torisch mit Eckenradius
Torical with corner radius

FB-Flatball
Flatball

SF-SuperFinish
SuperFinish

7 CopyMax

Kugel-Kopierfräser zum Schruppen und Vorschlichten mit
ein- oder doppelseitig verwendbarer Schneidplatte
Ball nose copy cutters for roughing and semi-finishing with
single- or double-sided insert
(Seite Page 320)

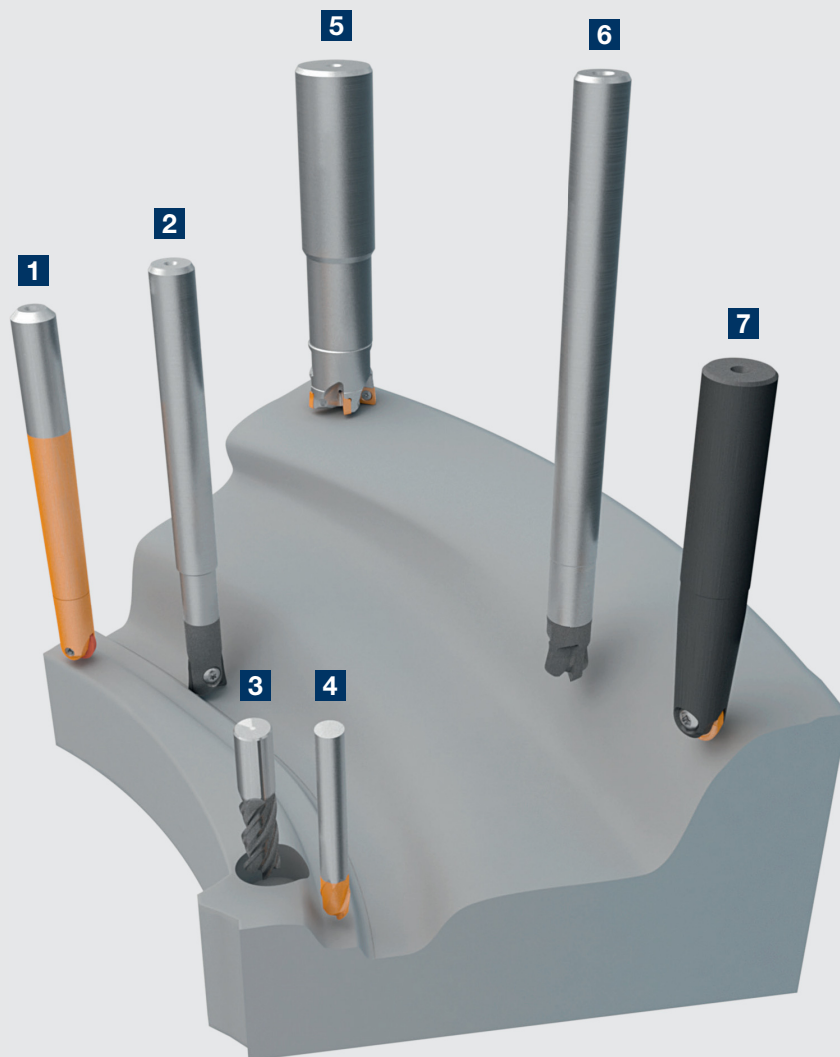

1 Sonder Profilfräser

Geometrie für Titanbauteile, kurze Späne dank Spanbrecher
Special profile cutter geometry for titanium components,
short chips thanks chipbreaker

2 65-200B

Kugel-Kopierfräser speziell zum Bearbeiten von Kunststoff.
Beispiel: Patella im Kniegelenk
Ball nose end mill designed for machining plastics.
Example: Patella
(Seite Page 124)

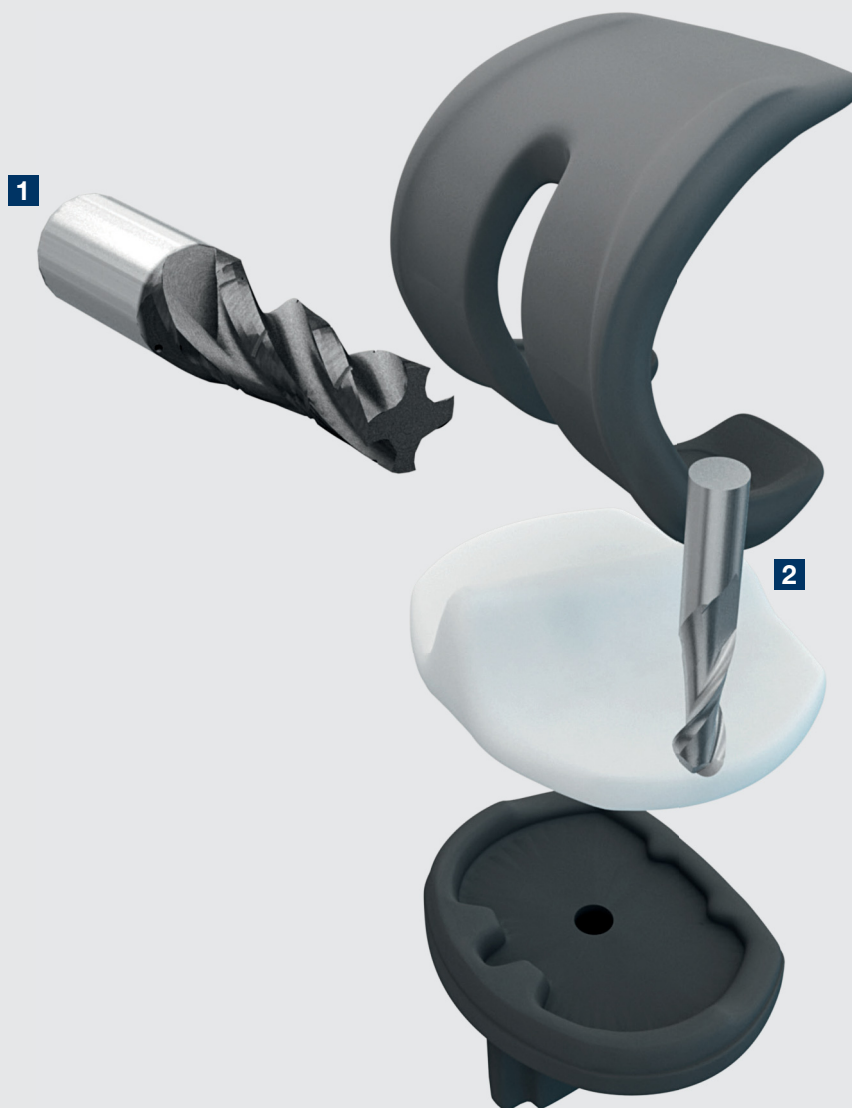

1 Feed-Jet PLUS

Messerkopfsystem für die Schrupp- und Schlichtbearbeitung von Aluminium-Legierungen
Milling cutter system for roughing and finishing of aluminium alloys
(Seite Page 300)

2 Sonder VHM-Fräser

Vollhartmetall Sonderfräser mit Aluminium Geometrie zum Schruppen und Schlichten der Taschen und Wände
Solid carbide special end mill for roughing and finishing of the pockets and walls

3 FinishLine Premium

Hochgenaues Werkzeug zum Vorschlichten und Schlichten
High-precision tool for semi-finishing and finishing
(Seite Page 315)

4 Univex Premium

Universelles Plan- und Eckfrässystem für exakte 90° Eckfräsoperationen
Universal Face- and shoulder milling system for precise 90° shoulders
(Seite Page 218)

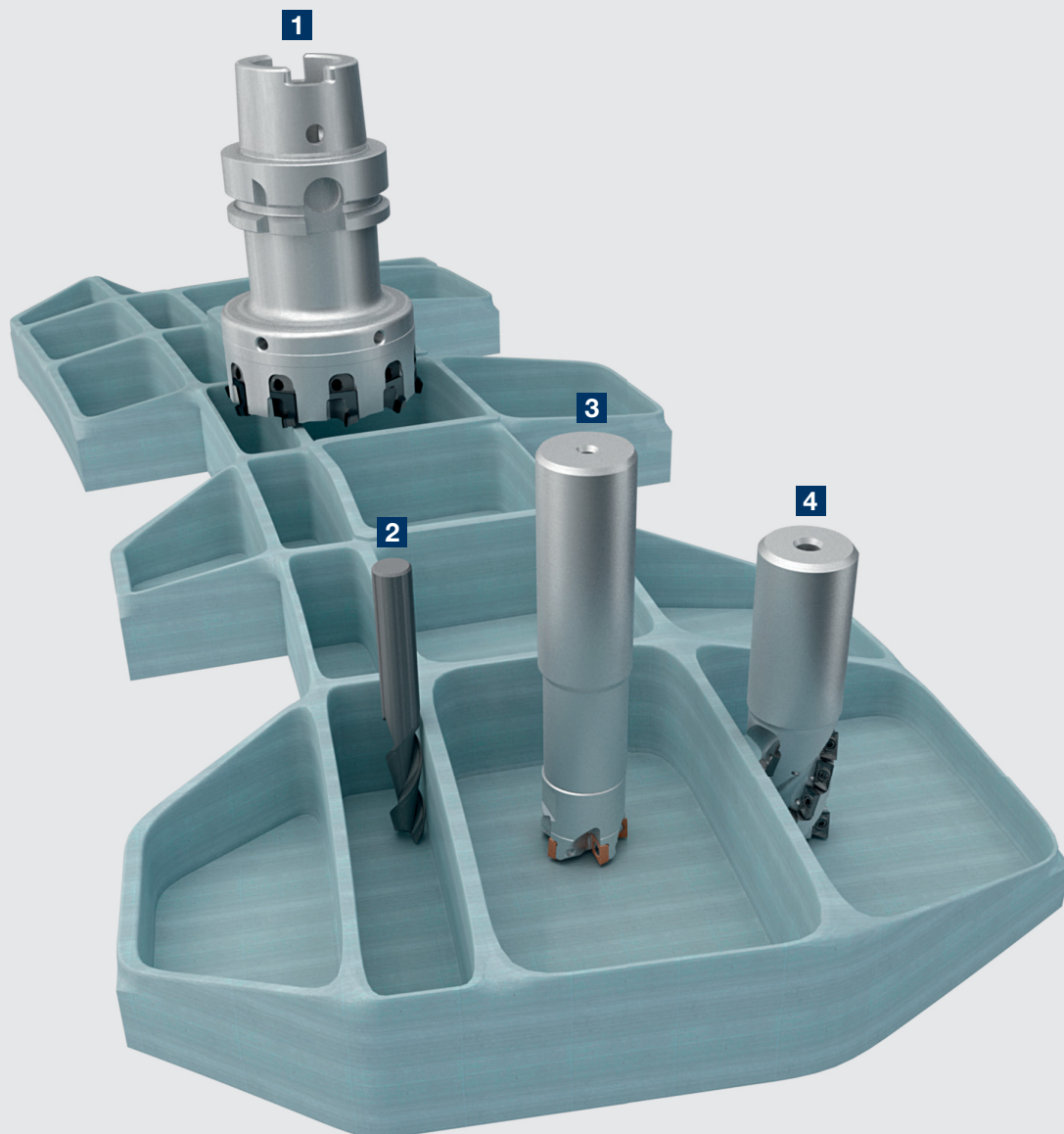

1 Univex Premium
Universelles Plan- und Eckfrässystem für exakte 90° Eckfräsoperationen
Universal Face- and shoulder milling system for precise 90° shoulders
(Seite Page 218)

2 MultiEdge 2Feed mini
Weichschneidender Hochvorschubfräser für sehr dynamische Maschinen
Soft cutting high feed milling cutters for dynamic machining centers
(Seite Page 274)

3 DHC Premium
Universeller VHM-Fräser für vibrationsarme Zerspanungsaufgaben
Universal solid carbide end mill for machining processes low on vibrations
(Seite Page 64)

4 MultiFace P45 PRO8
Weichschneidendes Planfrässystem für labile Aufspannungen
Smooth cutting face milling system unstable conditions
(Seite Page 250)

5 MultiEdge T90 PRO8
Tangentiales Eckfrässystem mit direkt gepresster 8-schneidiger Wendeschneidplatte
Tangential shoulder milling system with 8-sided press-to-size-insert
(Seite Page 232)

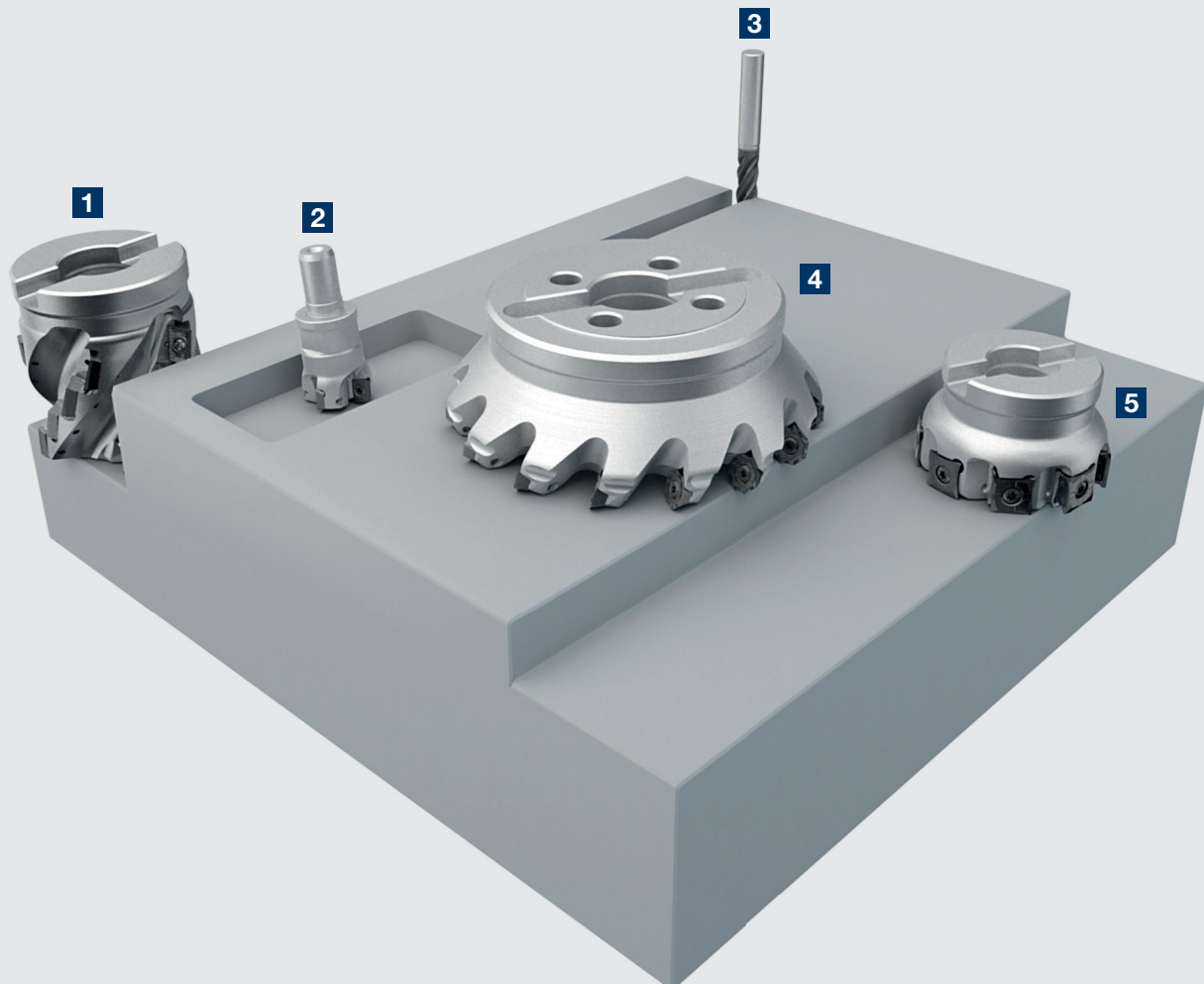

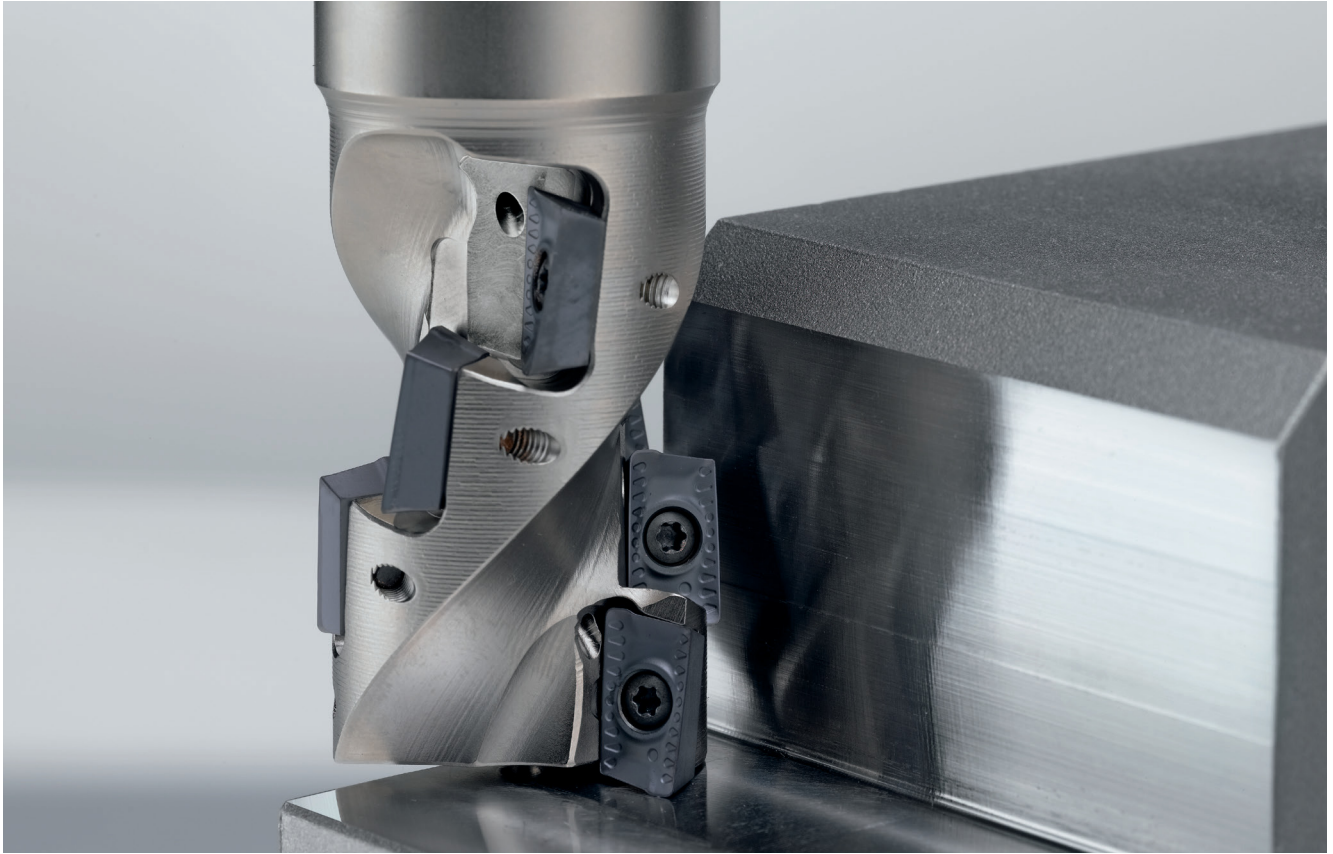

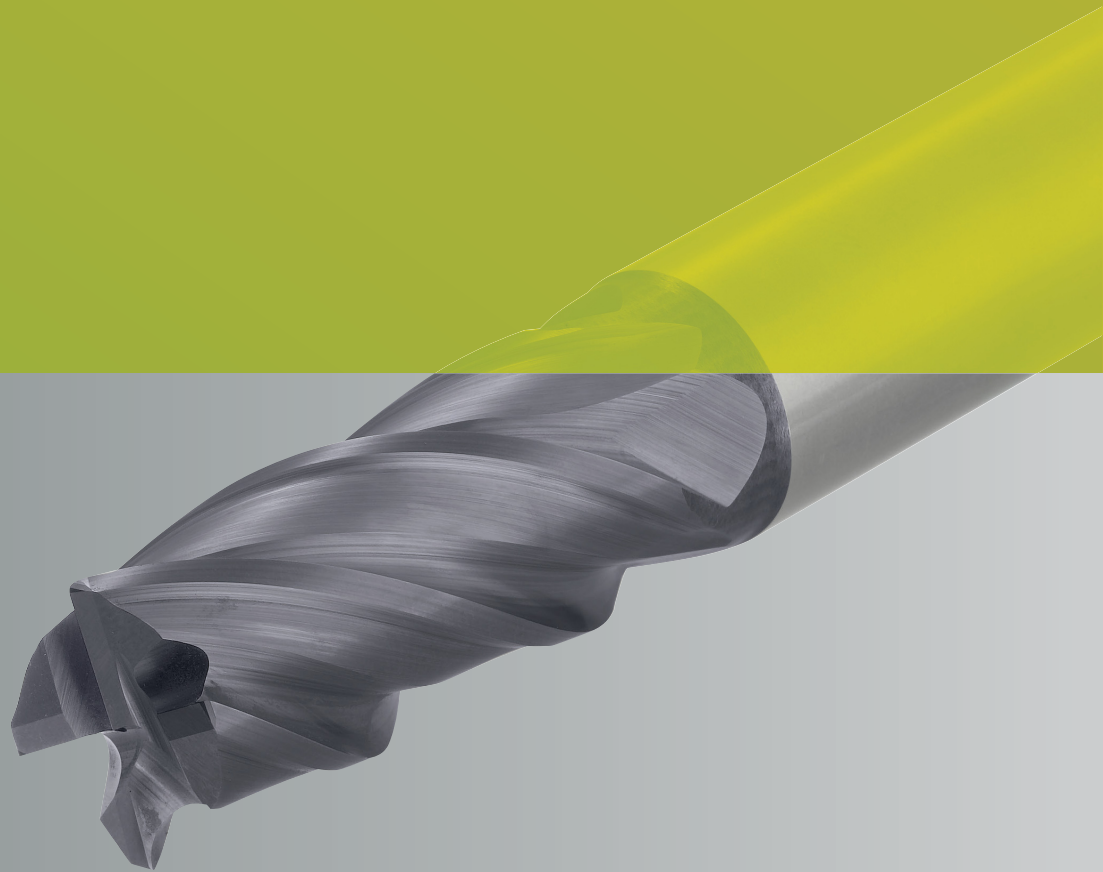

FRÄSEN

MIT SCHAFTFRÄSERN
AUS VOLLHARTMETALL
MILLING WITH SOLID CARBIDE
END MILLS

Fräsen mit Schafffräsern aus Vollhartmetall Milling with solid carbide end mills

16 **Schnellauswahlübersicht**
Selection table

18 **Typenbeschreibungen**
Type descriptions

Universale Hochleistungs-Fräser Universal HPC end mills

30 SN45
Schafffräser zum Eckfräsen
End mills for profiling

36 DHC Slot, HSCline N
Schafffräser zum Nut-/Eckfräsen
End mills for slotting and profiling

47 Flatball HSC, HSCline N
Kugelnkopierfräser
Ball nose end mills

54 HSCline MultiEdge 2Feed
Hochvorschubfräser
HFC end mills

Hochleistungs-Fräser für die Bearbeitung von Stahl (ISO-P) und Guss-Materialien (ISO-K) HPC end mills for Steel (ISO-P) and Cast Iron (ISO-K)

58 DHC
Schafffräser zum Nut-/Eckfräsen
End mills for slotting and profiling

64 DHC Premium
Schafffräser zum Nut-/Eckfräsen
End mills for slotting and profiling

Hochleistungs-Fräser für die Bearbeitung von rostfreiem Stahl (ISO-M) HPC end mills for machining Stainless Steel (ISO-M)

68 DHC Inox
Schafffräser zum Nut-/Eckfräsen
End mills for slotting and profiling

72 DHC Inox Premium
Schafffräser zum Nut-/Eckfräsen
End mills for slotting and profiling

Hochleistungs-Fräser für die Bearbeitung von Aluminium (ISO-N) HPC end mills for machining Stainless Steel (ISO-N)

76 AIRline
Schafffräser zum Nut-/Eckfräsen
End mills for slotting and profiling

Hochleistungs-Fräser für die Bearbeitung von gehärteten Materialien (ISO-H) HPC end mills for machining hardened materials (ISO-H)

80 HSCline SN, HSCline H
Schafffräser zum Eckfräsen
End mills for profiling

88 DHC Hardline
Schafffräser zum Nut-/Eckfräsen
End mills for slotting and profiling

92 HSCline Superfinish2
Kugelnkopierfräser
Ball nose end mills

Schnittwertempfehlungen und technische Hinweise finden Sie direkt nach jedem Produkt.
Please find cutting data recommendations and technical hints right after each product.

Hochleistungs-Fräser für die Bearbeitung von gehärteten Materialien (ISO-H)

HPC end mills for machining hardened materials (ISO-H)

94 HSCline Superfinish4
Kugelnkopierfräser
Ball nose end mills

98 HSCline H
Kugelnkopierfräser
Ball nose end mills

102 HSCline MultiEdge 4Feed
Hochvorschubfräser
HFC end mills

Hochleistungs-Fräser für die Bearbeitung Honeycomb, Composite & Plastik (ISO-O)

HPC end mills for machining Honeycomb, Composite & Plastic (ISO-O)

106 Schafffräser zum Nut-/Eckfräsen von weichem Kunststoff
End mills for slotting and profiling of Soft Plastic

106 Schafffräser zum Nut-/Eckfräsen für harten Kunststoff
End mills for slotting and profiling of hard plastic

110 Schafffräser zum Nut-/Eckfräsen für Faserverbundstoffe
End mills for slotting and profiling of Composite

120 Schafffräser zum Nut-/Eckfräsen für Wabenmaterial
End mills for slotting and profiling of Honeycomb

Universelle Schafffräser für die allgemeine Anwendung Universal end mills for general purpose

128 Chipmaster RFT
Schruppfräser mit Kordel Profil
Roughing end mills with Kordel profile

130 Bohrnutenfräser (Typ N)
Slotting end mills (Type N)

131 Schafffräser zum Nut-/Eckfräsen (Typ N)
End mills for slotting and profiling (Type N)

136 Kugelnkopierfräser (Typ N)
Ball nose end mills (Type N)

Micro HSCline Micro High Speed Cutting

140 Micro HSCline
Mikrofräser für den Maschinenbau und die Decolletage-
industrie
Micro cutter for general machining incl. Decolletage

144 Micro HSCline
Mikrofräser für den Gesenk- und Formenbau
Micro cutter for mold and die

148 Micro HSCline
Mikrofräser für die Graphit-Elektrodenbearbeitung
Micro cutter for machining graphite electrodes

150 Micro HSCline
Mikrofräser für die Dental- und Medizintechnik
Micro cutter for dental and medical technology

Trochoidal / Dynamisches Fräsen Trochoidal / Dynamic milling

156 Werkzeug- und Schnittwertempfehlungen für Schafffräser
Tool- and cutting data recommendations for end mills

Quattro-Jet Quattro-Jet

160 Quattro-Jet Wechselköpfe
Quattro-Jet Change milling cutters





166 Hartmetall-Verlängerungen für Aufschraubfräser
und Quattro-Jet-Wechselköpfen
Carbide extensions für screw-on type milling cutters
and Quattro-Jet Change milling cutters

Tool Guide

Tool guide

1. Wählen Sie Ihre Anwendung

Choose your application

 Eckfräsen Corner milling	 Trochoidalfräsen Trochoidal milling
 Eck-/Nutfräsen Corner/Slot milling	 HSC Mikrofräser HSC Micro cutters
 Kopierfräsen Copying	







2. Wählen Sie das Anwendungsfeld/Materialfeld für Ihre Anwendung aus

Choose your application area/material for your application

Universelle Hochleistungsfräser HPC Universal	
P	Stahl, Stahlguss, rostfreier Stahl, ferritisch und martensitisch Steel, cast steel, stainless steel, ferritic and martensitic
M	Rostfreier Stahl und Stahlguss, austenitisch und austenitisch/ferritisch Stainless steel and cast steel, austenitic and austenitic/ferritic
K	Grauguss, Sphäroguss, Temperguss Grey cast iron, cast iron with spheroidal graphite, malleable cast iron
N	Aluminium und andere Nichteisenmetalle, Kunststoffe, Graphit Aluminium and other non ferrous metals, plastic, graphite
S	Hochwarmfeste Stähle, Super- und Titanlegierungen High temperature alloys, super and titanium alloys
H	Gehärteter Stahl und Stahlguss Hardened steel and cast steel
O	Faserverbund- und Kunststoffe Composite and plastic
Allgemeine Anwendung General purpose	







3. Wählen Sie die von Ihnen benötigte Stirngeometrie, Spiralwinkel, Länge sowie Zähnezahl

Choose your front geometry, helix angle and number of teeth

 Eckenradius (R) Corner radius	 Hochvorschub (F) High feed
 Kugelstirn (B) Ball nose	 Kantenschutzfase (E) Edge protection
 Gerade (S) Straight corner	
 Drillwinkel 45° Spiral angle 45°	 DIN 6527 L













4. Für mehr Details gelangen Sie mit dem Seitenverweis auf die entsprechende Katalogseite

For further details see the page reference for the corresponding catalog page

1 Länge / Norm Length / Norme	SN45	30
2 Eckenausführung Corner version		
3 Spiralwinkel Helix angle	Ø 6–25 mm z = 6–8	
	  	
	  	

Auswahlübersicht Fräsen mit Schafffräsern aus Vollhartmetall

Selection table milling with solid carbide end mills

	 Eckfräsen Corner milling	 Eck-/Nutenfräsen Slot/Corner milling							
Universelle Hochleistungsfräser HPC Universal	SN45 30  Ø 6–25 mm z = 6–8 DIN 6527L  	SN45 31  Ø 3–20 mm z = 3 DIN 6527L  	DHC Slot 36  Ø 4–20 mm z = 3 DIN 6527L  	HSCline N 42  Ø 1–16 mm z = 2–4 LMT Fette Standard  					
	P		DHC 58  Ø 2–20 mm z = 2–4 DIN 6527L  	DHC Premium 64  Ø 1–20 mm z = 4 DIN 6527L  					
	M		DHC Inox 68  Ø 4–20 mm z = 4 DIN 6527L  	DHC Inox Premium 72  Ø 4–20 mm z = 4 DIN 6527L  					
	K		DHC 58  Ø 2–20 mm z = 4 DIN 6527L  	DHC Premium 64  Ø 1–20 mm z = 4 DIN 6527L  					
	N		Airline 76  Ø 4–25 mm z = 2–3 DIN 6527L  						
	S		DHC Inox 68  Ø 4–20 mm z = 4 DIN 6527L  	DHC Inox Premium 72  Ø 4–20 mm z = 4 DIN 6527L  					
	H	HSCline SN50 80  Ø 2–20 mm z = 4–8 DIN 6527L  LMT Fette Standard  	HSCline H 84  Ø 1–12 mm z = 2–4 LMT Fette Standard  	DHC Hardline 89  Ø 6–20 mm z = 4 DIN 6527L  					
O	Werkzeuge für Kunststoff Tools for plastic 106  LMT Onsrud Standard    		Werkzeuge für Faserverbundstoffe Tools for composites 110  LMT Onsrud Standard   						
	63-850 106 Ø 2–10 mm z = 1	64-000 107 Ø 3–10 mm z = 1	52-700 108 Ø 12–20 mm z = 2	60-200 109 Ø 8–12 mm z = 3	54-200 110 Ø 6–12 mm z = 4	66-500 111 Ø 3–12 mm z = 6–14	66-700 112 Ø 6–12 mm z = 6–10	66-750 113 Ø 6–12 mm z = 4–8	66-775 114 Ø 6–12 mm z = 4–8
				 LMT Onsrud Standard    116	66-800 115 Ø 6–12 mm z = 4–6	66-900 116 Ø 4–12 mm z = Multi	67-200 117 Ø 10–12 mm z = 3	68-200 118 Ø 6–12 mm z = 2	68-300 119 Ø 8–16 mm z = 3
Allgem. Anwendung General purpose		Chipmaster RFT 128  Ø 6–25 mm z = 3–4 DIN 6527L   	Bohrnutenfräser Typ N 130  Ø 2–12 mm z = 2 DIN 6527K  	Bohrnutenfräser Typ N 131  Ø 2–14 mm z = 3 DIN 6527K   	Bohrnutenfräser Typ N 132  Ø 4–25 mm z = 4 DIN 6527K  				



Kopierfräsen Copying

Flatball HSC

47



Ø 4–12 mm
z = 2



HScline N

50



Ø 1–20 mm
z = 2–4



MultiEdge 2Feed HSC

54



Ø 1–12 mm
z = 2



HScline SuperFinish2

93



Ø 4–12 mm
z = 2



HScline SuperFinish4

94



Ø 6–12 mm
z = 4



HScline H

98



Ø 1–12 mm
z = 2–4



Werkzeuge für Wabenmaterial Tools for honeycomb

120



29-050 120
Ø 6–63 mm
z = 6–20

29-100 121
Ø 12–16 mm
z = 8–10

32-200 122
Ø 45–63 mm
z = Multi

Werkzeuge für Kunststoff Tools for plastic

124



65-200B 124
Ø 3–10 mm
z = 2

77-100 125
Ø 3–6 mm
z = 2–3

Werkzeuge für Faserverbundstoffe Tools for composites

126



68-400
Ø 6–12 mm
z = 2

Kopierfräser Typ N Ballnose endmill type N

136



Ø 3–20 mm
z = 2



Dynamisches Fräsen
Dynamic milling

Micro HSC line
Microfräser
Micro cutter

--	--	--	--

--	--	--	--

--	--	--	--

--	--	--	--

--	--	--	--

--	--	--	--









--	--	--	--

--	--	--	--

--	--	--	--







--	--	--	--

	Typ Type	Typenbeschreibung	Type description	
	SN45	Hochgedrallter Schlichtfräser mit hoher Zähnezahl zur Kantenbearbeitung Werkstoffgruppe: P, M, K, N, S Ausführung: lang und extra lang Merkmale: Drallsteigung 45°, stirnseitig bis Mitte schneidend, Mehrschneider	High angle finishing end mills with high number of teeth for side milling Material group: P, M, K, N, S Design: long and extra long Features: Helix angle 45°, center cutting, multiple flutes	
	SN45	Hochgedrallter Schlichtfräser zur Kantenbearbeitung Werkstoffgruppe: P, M, K, N, S Ausführung: lang Merkmale: Drallsteigung 45°, stirnseitig bis Mitte schneidend, 3-Schneider, mit gerader Stirn oder Kantenschutzfase	High angle finishing end mills for side milling Material group: P, M, K, N, S Design: long Features: Helix angle 45°, center cutting, 3-flutes, with straight corner or edge protection chamfer	
	DHC SLOT	DHC SLOT (D ifferent H elix C utter) Schrupp- und Schlichtfräser mit ungleicher Drallsteigung, Untermaßfräser zur Herstellung von Nuten Werkstoffgruppe: P, M, K, N, S Ausführung: kurz Merkmale: Stirnseitig bis Mitte schneidend, 3-Schneider, mit Kantenschutzfase	DHC SLOT (D ifferent H elix C utter), roughing and finishing end mills with different helix angles, undersize cutters for slot milling Material group: P, M, K, N, S Design: short Features: Center cutting, 3-flutes, with edge protection chamfer	
	DHC SLOT	DHC SLOT IK (D ifferent H elix C utter) Schrupp- und Schlichtfräser mit ungleicher Drallsteigung zur Herstellung von Nuten Werkstoffgruppe: P, M, K, N, S Ausführung: lang Merkmale: Zentrale Innenkühlung, stirnseitig bis Mitte schneidend, 3-Schneider, mit Kantenschutzfase	DHC SLOT IK (D ifferent H elix C utter), roughing and finishing end mills with different helix angles for slot milling Material group: P, M, K, N, S Design: long Features: Central internal cooling, center cutting, 3-flutes, with edge protection chamfer	
	HSCline N	HSCline Typ N, Hochgeschwindigkeits-Schlichtfräser Werkstoffgruppe: P, M, K, N, S, H Ausführung: kurz, lang und extra lang Merkmale: Eckenradius, stirnseitig bis Mitte schneidend, Mehrschneider	HSCline Type N, High-Speed-Cutting finishing end mills Material group: P, M, K, N, S, H Design: short, long and extra long Features: Corner radius, center cutting, multiple flutes	
	FlatBall® N	HSC Kopierfräser mit torischer Schneidengeometrie für den Gesenk- und Formenbau Werkstoffgruppe: P, M, K, N, S, H Ausführung: kurz, lang und lang verstärkt Merkmale: „FlatBall“-Geometrie, keine Schnittgeschwindigkeit null im Zentrum, mit Eckenradius, stirnseitig bis Mitte schneidend, 2-Schneider	HSC copy end mills, with torical cutting edge geometry for mold and die Material group: P, M, K, N, S, H Design: short, long and long reinforced Features: „FlatBall“ geometry, no zero cutting speed in center, with corner radius, center cutting, 2-flutes	
	HSCline N	HSCline Typ N, Hochgeschwindigkeits-Kopierfräser Werkstoffgruppe: P, M, K, N, S, H Ausführung: kurz, lang und extra lang Merkmale: Kugelstirn, stirnseitig bis Mitte schneidend, 2- und 4-Schneider	HSCline Type N, High-Speed-Cutting copy end mills Material group: P, M, K, N, S, H Design: short, long and extra long Features: Ball nose, center cutting, 2- and 4-flutes	







	Stirngeometrie Front	Schaft nach DIN Shank	Schneidstoffsorte Carbide Grade	Kat. Nr. Cat. No. unbeschichtet uncoated	Kat. Nr. Cat. No. beschichtet coated	Seite Page
		6535 HA	LC630T		1528C	30
		6535 HB			1529C	30
		6535 HA	LC630T		1461C	31
		6535 HB			1462C	31
		6535 HB			1464C	32
		6535 HA	LC630T		1524C	36
					1526C	37
		6535 HB			1544C	36
					1576C	37
		6535 HB	LC630T		1550C	38
		6535 HA	LC620T		1410C	42
		6535 HA	LC620Q		1400C	47
		6535 HA	LC620T		1412C	50









	Typ Type	Typenbeschreibung	Type description	
	MultiEdge 2Feed	MultiEdge 2Feed Hochvorschubfräser Werkstoffgruppe: P, M, K, H Ausführung: extra kurz, kurz, lang und extra lang Merkmale: Sehr hohes Zeitspanvolumen, stirnseitig bis Mitte schneidend, 2-Schneider	MultiEdge 2Feed High-Feed-Cutting end mills Material group: P, M, K, H Design: extra short, short, long and extra long Features: Very high machining volume, center cutting, 2-flutes	
	DHC	DHC (D ifferent H elix C utter), Schrupp- und Schlichtfräser mit ungleicher Drallsteigung Werkstoffgruppe: P, K Ausführung: kurz und lang Merkmale: Stirnseitig bis Mitte schneidend, 4-Schneider, mit Kantenschutzfase	DHC (D ifferent H elix C utter), roughing and finishing end mills with different helix angles Material group: P, K Design: short and long Features: Center cutting, 4-flutes, with edge protection chamfer	
	DHC	DHC (D ifferent H elix C utter), Schrupp- und Schlichtfräser mit ungleicher Drallsteigung Werkstoffgruppe: P, K Ausführung: kurz und lang Merkmale: Mit Eckenradius, stirnseitig bis Mitte schneidend, 4-Schneider	DHC (D ifferent H elix C utter), roughing and finishing end mills with different helix angles Material group: P, K Design: short and long Features: With corner radius, center cutting, 4-flutes	
	DHC Premium	DHC Premium (D ifferent H elix C utter) Schrupp- und Schlichtfräser mit ungleicher Drallsteigung zur Hochleistungserspannung Werkstoffgruppe: P, K Ausführung: kurz, lang und extra lang Merkmale: Stirnseitig bis Mitte schneidend, 4-Schneider, mit Kantenschutzfase	DHC Premium (D ifferent H elix C utter), roughing and finishing end mills with different helix angles for high performance cutting Material group: P, K Design: short, long and extra long Features: Center cutting, 4-flutes, with edge protection chamfer	
	DHC INOX	DHC INOX (D ifferent H elix C utter), Schrupp- und Schlichtfräser mit ungleicher Drallsteigung Werkstoffgruppe: M, N, S Ausführung: kurz und lang Merkmale: Stirnseitig bis Mitte schneidend, 4-Schneider, mit Kantenschutzfase	DHC INOX (D ifferent H elix C utter), roughing and finishing end mills with different helix angles Material group: M, N, S Design: short and long Features: Center cutting, 4-flutes, with edge protection chamfer	
	DHC INOX Premium	DHC INOX Premium (D ifferent H elix C utter) Schrupp- und Schlichtfräser mit ungleicher Drallsteigung zur Hochleistungserspannung Werkstoffgruppe: M, N, S Ausführung: kurz und lang Merkmale: Stirnseitig bis Mitte schneidend, 4-Schneider, mit Eckenradius	DHC INOX Premium (D ifferent H elix C utter), roughing and finishing end mills with different helix angles for high performance cutting Material group: M, N, S Design: short and long Features: Center cutting, 4-flutes, with corner radius	

	Stirngeometrie Front	Schaft nach DIN Shank	Schneidstoffsorte Carbide Grade	Kat. Nr. Cat. No. unbeschichtet uncoated	Kat. Nr. Cat. No. beschichtet coated	Seite Page
		6535 HA	LC620T		1430C	54
		6535 HA	LC630T		1521C	58
		6535 HB			1522C	58
		6535 HB	LC630T		1520C	60
		6535 HA	LCPK30M		1820C	64
		6535 HB			1821C	64
		6535 HA	LC630T		1525C	68
		6535 HB			1565C	68
		6535 HA	LCMS30M		1830C	72
		6535 HB			1831C	72











	Typ Type	Typenbeschreibung	Type description
	DHC INOX Premium	DHC INOX Premium IK (D ifferent H elix C utter) Schrupp- und Schlichtfräser mit ungleicher Drallsteigung zur Hochleistungszerspanung Werkstoffgruppe: M, N, S Ausführung: lang Merkmale: Radiale Innenkühlung, stirnseitig bis Mitte schneidend, 4-Schneider, mit Eckenradius	DHC INOX Premium IC (D ifferent H elix C utter), roughing and finishing end mills with different helix angles for high performance cutting Material group: M, N, S Design: long Features: Radial internal cooling, center cutting, 4-flutes, with corner radius
	AIRline SH	AIRline Schlichtfräser Werkstoffgruppe: N Ausführung: lang Merkmale: Speziell für Aluminium und Kunststoffe, scharfe Schneidkantenausführung, große Spankammern, Drallwinkel 20°, bei zentraler Innenkühlung Drallwinkel 30°, 2- und 3-Schneider	AIRline finishing end mills Material group: N Design: long Features: Especially for machining aluminum and plastics, sharp cutting edges, large flutes, helix angle 20°, helix angle 30° for end mills with central internal cooling, 2- and 3-flutes
	HSCline SN50	HSCline Typ SN50, Hochgedrallter Hochgeschwindigkeits-Schlichtfräser mit hoher Zähnezahl zur Kantenbearbeitung Werkstoffgruppe: P, K, H Ausführung: lang Merkmale: Eckenradius, Drallsteigung 50°, stirnseitig bis Mitte schneidend, Mehrschneider	HSCline Type SN50, High angle High Speed-Cutting finishing end mills with high number of teeth for side milling Material group: P, K, H Design: long Features: Corner radius, helix angle 50°, center cutting, multiple flutes
	HSCline H	HSCline Typ H, Hochgeschwindigkeits-Schlichtfräser Werkstoffgruppe: P, K, H Ausführung: kurz und lang Merkmale: Für hochfeste und gehärtete Materialien, mit Eckenradius, stirnseitig bis Mitte schneidend, 2- und 4-Schneider	HSCline Type H, High-Speed-Cutting finishing end mills Material group: P, K, H Design: short and long Features: For high strength steel and hardened materials, corner radius, center cutting, 2- and 4-flutes
	HSCline H	HSCline Typ H, Hochgeschwindigkeits-Kopierfräser Werkstoffgruppe: P, K, H Ausführung: kurz und lang Merkmal: Für hochfeste und gehärtete Materialien, mit Kugelstirn, stirnseitig bis Mitte schneidend, 2- und 4-Schneider	HSCline Type H, High-Speed-Cutting copy end mills Material group: P, K, H Design: short and long Features: For high strength steel and hardened materials, ball nose, center cutting, 2- and 4-flutes
	MultiEdge 4Feed	MultiEdge 4Feed Hochvorschubfräser Werkstoffgruppe: P, K, H Ausführung: extra kurz, kurz und lang Merkmale: Sehr hohes Zeitspanvolumen, für hochfeste und gehärtete Materialien, stirnseitig bis Mitte schneidend, 4-Schneider	MultiEdge 4Feed High-Feed-Cutting end mills Material group: P, K, H Design: extra short, short, long Features: Very high machining volume for high strength steel and hardened materials, center cutting, 4-flutes
	RFT45	Chipmaster Schruppfräser mit Spanteilerprofil zur Reduzierung der Schnittkräfte Werkstoffgruppe: P, K Ausführung: lang Merkmale: Drallwinkel 45°, stirnseitig bis Mitte schneidend, 3- und 4-Schneider, mit Kantenschutzfase	Chipmaster Roughing end mills with chip-breaker profil for reduction of cutting forces Material group: P, K Design: long Features: Helix angle 45°, center cutting, 3- and 4-flutes, with edge protection chamfer

	Stirngeometrie Front	Schaft nach DIN Shank	Schneidstoffsorte Carbide Grade	Kat. Nr. Cat. No. unbeschichtet uncoated	Kat. Nr. Cat. No. beschichtet coated	Seite Page
		6535 HB	LCMS30M		1837C	73
		6535 HA	LW630	1571		76
		6535 HB		1572		76
		6535 HA	LC620ZM		1413C	80
					1411C	80
					1443C	81
		6535 HB	LC620ZM		1450C	84, 85
		6535 HB	LC620ZM		1451C	98
		6535 HA	LC620ZM		1431C	102
		6535 HA	LC630T		1563C	128
		6535 HB		1564C	128	











	Typ Type	Typenbeschreibung	Type description	
	RFT25	Chipmaster Schrupfräser mit Spanteilerprofil zur Reduzierung der Schnittkräfte Werkstoffgruppe: P, K Ausführung: lang Merkmale: Drallwinkel 25°, stirnseitig bis Mitte schneidend, 4-Schneider, mit Kantenschutzfase	Chipmaster Roughing end mills with chip-breaker profil for reduction of cutting forces Material group: P, K Design: long Features: Helix angle 25°, center cutting, 4-flutes, with edge protection chamfer	
	N	Universal Bohrnutenfräser Werkstoffgruppe: P, M, K, N Ausführung: kurz und lang Merkmale: Stirnseitig bis Mitte schneidend 2-Schneider, mit Untermaßen und Zwischenabmessungen	Universal slotting end mills Material group: P, M, K, N Design: short and long Features: Center cutting, 2-flutes, with undersize and intermediate dimensions	
	N	Universal Schlichtfräser Werkstoffgruppe: P, M, K, N Ausführung: kurz und lang Merkmale: Stirnseitig bis Mitte schneidend, 3-Schneider, mit Zwischenabmessungen	Universal finishing end mills Material group: P, M, K, N Design: short and long Features: Center cutting, 3-flutes, with intermediate dimensions	
	N	Universal Schlichtfräser Werkstoffgruppe: P, M, N Ausführung: kurz und lang Merkmale: Stirnseitig bis Mitte schneidend, 4-Schneider, mit Zwischenabmessungen	Universal finishing end mills Material group: P, M, N Design: short and long Features: Center cutting, 4-flutes, with intermediate dimensions	
	N	Kugelkopierfräser zum Schlichten Werkstoffgruppe: P, M, K, N Ausführung: lang Merkmal: 2-Schneider	Copy end mills for finishing operations Material group: P, M, K, N Design: long Features: Ball nose, 2-flute	
	Micro HSCline	HSC-Mikrofräser für den allgemeinen Maschinenbau und die Decolletageindustrie Werkstoffe: P, K, N Ausführung: extra kurz, kurz, extra lang Merkmale: Gerade Stirn, 2-Schneider, Anti-Vibrationshalsform	HSC-Micro end mills for general machining and decolletage industry Material group: P, K, N Design: extra short, short and extra long Features: Straight corner, 2-flutes, Anti-Vibration-Neckform	
	Micro HSCline	HSC-Mikrofräser für den allgemeinen Maschinenbau und die Decolletageindustrie Werkstoffgruppe: P, K, N Ausführung: extra kurz, kurz und extra lang Merkmale: Kugelstirn, 2-Schneider, Anti-Vibrationshalsform	HSC-Micro end mills for general machining and decolletage industry Material group: P, K, N Design: extra short, short and extra long Features: Ball nose, 2-flutes, Anti-Vibration-Neckform	
	Micro HSCline	HSC-Mikrofräser für den Gesenk- und Formenbau Werkstoffgruppe: P, H Ausführung: extra kurz, kurz, lang und extra lang Merkmale: Eckenradius, 2-Schneider	HSC-Micro end mills for mold and die Material group: P, H Design: extra short, short, long and extra long Features: Corner radius, 2-flutes	

	Stirngeometrie Front	Schaft nach DIN Shank	Schneidstoffsorte Carbide Grade	Kat. Nr. Cat. No. unbeschichtet uncoated	Kat. Nr. Cat. No. beschichtet coated	Seite Page
		6535 HA	LC630T		1591C	129
		6535 HB			1592C	129
		6535 HA	LC630T		1426C	130
		6535 HB			1425C	130
		6535 HA	LC630T		1428C	131
		6535 HB			1429C	131
		6535 HA	LW630 LC630T	1585	1585C	132, 133
		6535 HB		1584	1584C	132, 133
		6535 HA	LC630T		1418C	136
		6535 HB			1417C	137
		6535 HA	LWNP30M LCPK30M	1415	1415C	140
		6535 HA	LWNP30M LCPK30M	1419	1419C	142
		6535 HA	LCHP15M		1465C	144



	Typ Type	Typenbeschreibung	Type description	
	Micro HSCline	HSC-Mikrofräser für den Gesenk- und Formenbau Werkstoffgruppe: P, H Ausführung: extra kurz, kurz, lang und extra lang Merkmale: Kugelstirn, 2-Schneider	HSC-Micro end mills for mold and die Material group: P, H Design: extra short, short, long and extra long Features: Ball nose, 2-flutes	
	Micro HSCline	HSC-Mikrofräser für die Graphit-Elektrodenbearbeitung Werkstoffgruppe: N Ausführung: kurz Merkmale: Hauptsächlich für Graphit, mit Eckenradius, 2-Schneider	HSC-Micro end mills for machining graphite electrodes Material group: N Design: short Features: Mainly for graphite, with corner radius, 2-flutes	
	Micro HSCline	HSC-Mikrofräser für die Graphit-Elektrodenbearbeitung Werkstoffgruppe: N Ausführung: extra lang Merkmale: Hauptsächlich für Graphit, Kugelstirn, 2-Schneider	HSC-Micro end mills for machining graphite electrodes Material group: N Design: extra long Features: Mainly for graphite, ball nose, 2-flutes	
	Micro HSCline	HSC-Mikrofräser für die Dental- und Medizintechnik Werkstoffgruppe: M, N, S Ausführung: extra kurz, kurz, lang und extra lang Merkmale: Gerade Stirn, 2-Schneider	HSC-Micro end mills for dental and medical technology Material group: M, N, S Design: extra short, short, long and extra long Features: Straight Corner, 2-flutes	
	Micro HSCline	HSC-Mikrofräser für die Dental- und Medizintechnik Werkstoffgruppe: M, N, S Ausführung: extra kurz, kurz, lang und extra lang Merkmale: Kugelstirn, 2-Schneider	HSC-Micro end mills for dental and medical technology Material group: M, N, S Design: extra short, short, long and extra long Features: Ball nose, 2-flutes	
	Quattro-Jet MFS-HF	Modulares Wechselkopfsystem zum Hochvorschubfräsen für den Gesenk- und Formenbau Werkstoffgruppe: P, M, K, S Ausführung: extra kurz Merkmale: Zentrale Innenkühlung, sehr hohes Zeitspanvolumen, 4-Schneider	Modular screw-in cutter for High-Feed-Cutting in mold and die Material group: P, M, K, S Design: extra short Features: Central internal cooling, very high chip volume rate, 4-flutes	
	Quattro-Jet MFS-FB	Modulares Wechselkopfsystem für den Gesenk- und Formenbau Werkstoffgruppe: P, M, K, S, H Ausführung: extra kurz Merkmale: „FlatBall“-Geometrie, keine Schnittgeschwindigkeit null im Zentrum, mit Eckenradius, 4-Schneider	Modular screw-in cutter for mold and die Material group: P, M, K, S, H Design: extra short Features: „FlatBall“ geometry, no zero cutting speed in center, with corner radius, 4-flutes	
	Quattro-Jet MFS-AF	Modulares Wechselkopfsystem für den Gesenk- und Formenbau Werkstoffgruppe: P, M, K, S, H Ausführung: extra kurz Merkmale: Eckenradius, 4-Schneider	Modular screw-in cutter for mold and die Material group: P, M, K, S, H Design: extra short Features: Corner radius, 4-flutes	

	Stirngeometrie Front	Schaft nach DIN Shank	Schneidstoffsorte Carbide Grade	Kat. Nr. Cat. No. unbeschichtet uncoated	Kat. Nr. Cat. No. beschichtet coated	Seite Page
		6535 HA	LCHP15M		1466C	146
		6535 HA	LCN15M		1468C	148
		6535 HA	LCN15M		1469C	149
		6535 HA	LCSM20M		1475C	150
		6535 HA	LCSM20M		1476C	151
		siehe Seite 166-167 see page 166-167	LCPK30M		HF	160
		siehe Seite 166-167 see page 166-167	LCKP10M		FB	160
		siehe Seite 166-167 see page 166-167	LCHK10M		AF	161

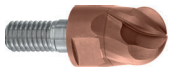

	Typ Type	Typenbeschreibung	Type description	
	Quattro-Jet MFS-SF	Modulares Wechselkopfsystem zum Kopierfräsen für den Gesenk- und Formenbau Werkstoffgruppe: P, M, K, S, H Ausführung: extra kurz Merkmale: Kugelstirn, gut geeignet zur Hartbearbeitung bis 65 HRC, gedallte Schneide, 4-Schneider	Modular screw-in copy cutter for mold and die Material group: P, M, K, S, H Design: extra short Features: Ball nose, suitable for hardened materials up to 65 HRC, 4-flutes	

	Stirngeometrie Front	Schaft nach DIN Shank	Schneidstoffsorte Carbide Grade	Kat. Nr. Cat. No. unbeschichtet uncoated	Kat. Nr. Cat. No. beschichtet coated	Seite Page
		siehe Seite 166-167 see page 166-167	LCHK10M		SF	161

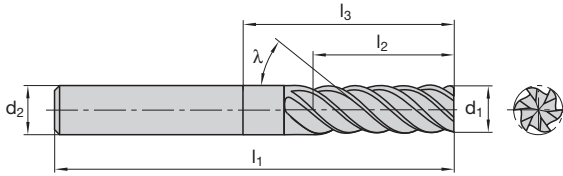

Katalog-Nr. Cat.-No.						1528C		1529C	
P						■		■	
M						■		■	
K						■		■	
N						□		□	
S						□		□	
H									
O									
d ₁	l ₂	l ₁	l ₃	d ₂	z	Ident No.	LMT-Code	Ident No.	LMT-Code
lang long									
6	13	57	21	6	6	1122051	EM-SN45 6x13/21 6SA	1100224	EM-SN45 6x13/21 6SB
8	19	63	27	8	6	1122064	EM-SN45 8x19/27 6SA	1100225	EM-SN45 8x19/27 6SB
10	22	72	32	10	6	1122078	EM-SN45 10x22/32 6SA	1100226	EM-SN45 10x22/32 6SB
12	26	83	38	12	6	1122091	EM-SN45 12x26/38 6SA	1100227	EM-SN45 12x26/38 6SB
16	32	92	44	16	6	1122105	EM-SN45 16x32/44 6SA	1100228	EM-SN45 16x32/44 6SB
20	38	104	54	20	8	1122117	EM-SN45 20x38/54 8SA	1100229	EM-SN45 20x38/54 8SB
extra lang extra long									
6	24	68	32	6	6	1301011	EM-SN45 6x24/32 6SA	1301001	EM-SN45 6x24/32 6SB
8	38	82	46	8	6	1301012	EM-SN45 8x38/46 6SA	1301002	EM-SN45 8x38/46 6SB
10	45	95	57	10	6	1301013	EM-SN45 10x45/57 6SA	1301003	EM-SN45 10x45/57 6SB
12	53	110	65	12	6	1301014	EM-SN45 12x53/65 6SA	1301004	EM-SN45 12x53/65 6SB
16	63	123	75	16	6	1301015	EM-SN45 16x63/75 6SA	1301005	EM-SN45 16x63/75 6SB
20	75	141	91	20	8	1301016	EM-SN45 20x75/91 8SA	1301006	EM-SN45 20x75/91 8SB
25	90	166	110	25	8	1301017	EM-SN45 25x90/110 8SA	1301007	EM-SN45 25x90/110 8SB

Schnittwertempfehlungen ab Seite 34
Cutting data recommendations starting page 34

■ = Hauptanwendung First choice
□ = Nebenanwendung Second choice

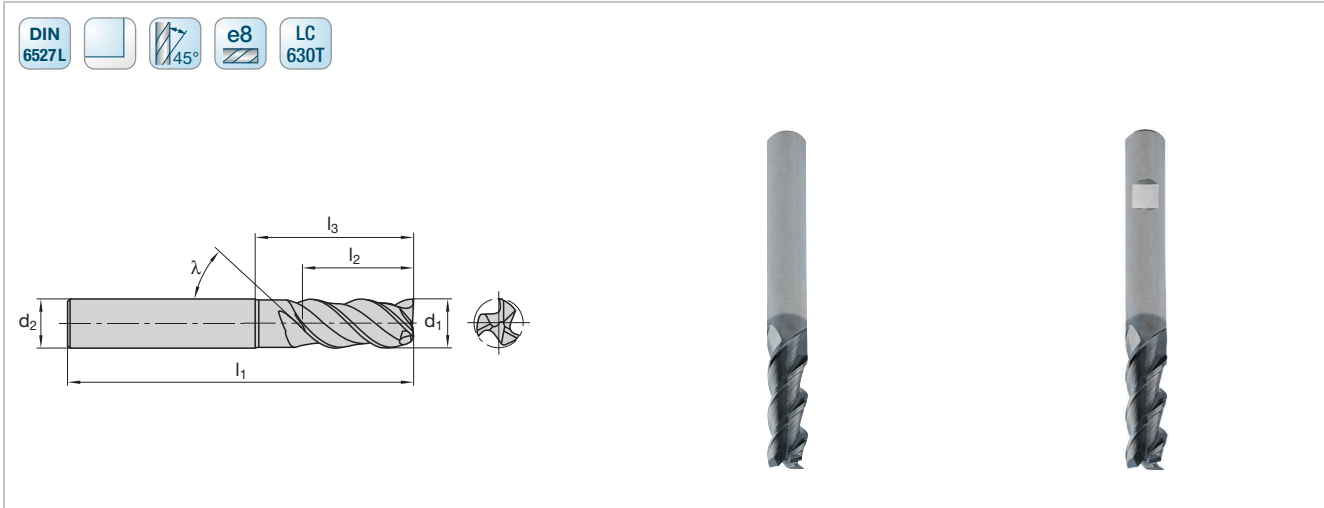

Katalog-Nr. Cat.-No.						1461C		1462C	
P						■		■	
M						■		■	
K						■		■	
N						□		□	
S						□		□	
H									
O									
d ₁	l ₂	l ₁	l ₃	d ₂	z	Ident No.	LMT-Code	Ident No.	LMT-Code
lang long									
3	8	57	18	6	3	1128654	EM-SN45 3x8/18 3SA	1128676	EM-SN45 3x8/18 3SB
4	11	57	19	6	3	1128655	EM-SN45 4x11/19 3SA	1128677	EM-SN45 4x11/19 3SB
5	13	57	19	6	3	1128656	EM-SN45 5x13/19 3SA	1128678	EM-SN45 5x13/19 3SB
6	13	57	21	6	3	1128657	EM-SN45 6x13/21 3SA	1128679	EM-SN45 6x13/21 3SB
8	19	63	27	8	3	1128658	EM-SN45 8x19/27 3SA	1128680	EM-SN45 8x19/27 3SB
10	22	72	32	10	3	1128659	EM-SN45 10x22/32 3SA	1128681	EM-SN45 10x22/32 3SB
12	26	83	38	12	3	1128660	EM-SN45 12x26/38 3SA	1128682	EM-SN45 12x26/38 3SB
16	32	92	44	16	3	1128662	EM-SN45 16x32/44 3SA	1128684	EM-SN45 16x32/44 3SB
20	38	104	54	20	3	1128664	EM-SN45 20x38/54 3SA	1128686	EM-SN45 20x38/54 3SB

Schnittwertempfehlungen ab Seite 34
Cutting data recommendations starting page 34

■ = Hauptanwendung First choice
□ = Nebenanwendung Second choice

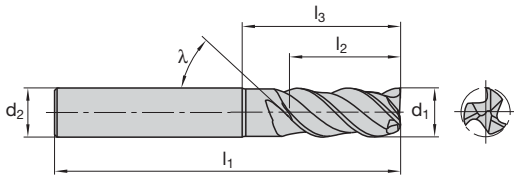

Katalog-Nr. Cat.-No.						1464C	
P						■	
M						■	
K						■	
N						□	
S						□	
H							
O							
d ₁	l ₂	l ₁	l ₃	d ₂	z	Ident No.	LMT-Code
lang long							
6	13	57	21	6	3	1128702	EM-SN45 6x13/21 3EB
8	19	63	27	8	3	1128703	EM-SN45 8x19/27 3EB
10	22	72	32	10	3	1128704	EM-SN45 10x22/32 3EB
12	26	83	38	12	3	1128705	EM-SN45 12x26/38 3EB
16	32	92	44	16	3	1128707	EM-SN45 16x32/44 3EB
20	38	104	54	20	3	1128709	EM-SN45 20x38/54 3EB

■ = Hauptanwendung First choice
□ = Nebenanwendung Second choice

Kantenschutzfase Edge protection chamfer	d ₁	b
	6-12	0,2
	14-20	0,3

Schnittwertempfehlungen ab Seite 34
Cutting data recommendations starting page 34



Fräsen mit Schlitzfräsen aus Vollhartmetall
Milling with solid carbide end mills

SN45
Schnittwertempfehlungen
Cutting data recommendations

				DIN Bezeichnung Alt		DIN Bezeichnung Neu
	Werkstoff	Material	Werkstoff-Nr. Material No.	DIN Description Old	R_m/UTS (N/mm²)	DIN Description New
P	Unlegierter Baustahl + Automatenstahl	Plain carbon steel + free cutting steel	1.0570	St52-3	-700	S355J2G3
			1.1730	C45	-800	C45U
			1.0715	9SMn28	-700	11SMn30
			1.1191 1.7219	Ck45 26CrMo4	500-950	C45E 26CrMo4-2
	Vergütungsstahl, mittelfest	Heat-treatment steel, medium strength	1.7225	42CrMo4	500-950	42CrMo4
	Stahlguss	Cast steel	1.8159	51CrV4		51CrV4
	Einsatzstahl	Case hardening steel	1.0416	GS40	-950	GS40
	Rost- und säurebe- ständiger Stahl, ferritisch, martensitisch	Stainless steel, ferritic, martensitic	1.7131	16MnCr5	-950	16MnCr5
			1.4006	X10Cr13	500-950	X12Cr13
			1.4104 1.4122	X12CrMoS17 X35CrMo17		X14CrMoS17 X39CrMo17-1
	Vergütungsstahl, hochfest	Heat-treatment steel, high strength	1.7225	42CrMo4	950-1400	42CrMo4
	Nitrierstahl, vergütet	Nitriding steel, heat treated	1.6580	30CrNiMo8		30CrNiMo8
			1.8504	34CrAl6	950-1400	34CrAl6
	Werkzeugstahl	Tool steel	1.2344	X40CrMoV5.1	-900	X40CrMoV5-1
			1.2343	X38CrMoV5 1	950-1400	X37CrMoV5-1
			1.2379	X155CrVMo12 1	-950	X153CrMoV12-1
			1.2358	60CrMoV18-5	850-1000	60CrMoV18-5
1.2080			X210Cr12	950-1400	X210Cr12	
1.2714			55NiCrMoV7	1100-1350	55NiCrMoV7	
1.2311			40CrMnMo7	-1100	40CrMnMo7	
1.2312			40CrMnNiMoS8.6	-1150	40CrMnNiMoS8-6	
1.2316			X38CrMo16	-1100	X38CrMo16	
1.2738			45CrMnNiMo8.6.4	950-1150	45CrMnNiMo8-6-4	
M	Rost- und säurebe- ständiger Stahl, austenitisch	Stainless steel, austenitic	1.4301	X2CrNiMo17-12-2	500-950	X5CrNiMo18-10
			1.4404	X6CrNiMoTi17-12-2		X2CrNiMo17-12-2
			1.4571	X10CrNiMoTi18		X10CrNiMoTi18
	Rost- und säurebe- ständiger Stahl, martensitisch aushärtbar	Stainless steel, martensitic steel	1.2709	X3NiCoMoTi18-9-5	800-1000	X3NiCoMoTi18-9-5
1.4542			X5CrNiCuNb16-4		X5CrNiCuNb16-4	
1.4568			X7CrNiAl17-7		X7CrNiAl17-7	
K	Grauguss	Grey cast iron	0.6025	GG25	100-400 (120-260 HB)	EN-GJL-250
	Legierter Grauguss	Alloyed grey cast iron	0.6678	GGL-NiCr35 2	150-250 (160-230 HB)	EN-GJLA-XNiCr35-2
	Sphäroguss	Nodular cast iron	0.7060 0.7070	GGG60 GGG70L	400-800 (120-310 HB)	EN-GJS-600-3 EN-GJS-700-2U
	Temperguss	Malleable cast iron	0.8155	GTS55	350-700 (150-280 HB)	EN-GJMB-550-4
N	Aluminium-Legierungen, kurzspanend	Aluminium alloys, short chipping	3.2581	G-AlSi12	-400	G-IGK-AlSi12
	Aluminium-Legierungen, langspanend	Aluminium alloys, long chipping	3.3535	AlMg3	-550	AlMg3
	Kupfer-Legierungen, kurzspanend	Copper alloys, short chipping	3.4365	AlZnMgCu1,5		AlZnMgCu1,5
	Kupfer-Legierungen, langspanend	Copper alloys, long chipping	2.0402	MS58	-500	CuZn40Pb2
	Thermoplaste	Thermoplastics	2.0320 2.0975	MS63 CuAl10Ni	300-500	CuZn37 CuAl10Fe5Ni5-C
	Duroplaste	Duroplastics		PVC	40-70	PVC
	Graphit	Graphite		Bakelit, Melamin	20-40	Bakelit, Melamin
S	Titan-Legierungen, mittelfest	Titanium alloys, medium strength	3.7115 3.7164	TiAl5Sn2,5 TiAl6V4	-950	TiAl5Sn2-5 TiAl6V4
	Titan-Legierungen, hochfest	Titanium alloys, high strength	3.7174	TiAl6Sn2	900-1400	TiAl6V6Sn2
	Nickelbasis-Legierungen, mittelfest	Nickel based alloys, medium strength	2.4670	NiCr12Al6MoNb	-950	NiCr12Al6MoNb
	Nickelbasis-Legierungen, hochwarmfest	Heat resistant nickel based alloys, high strength	2.4668	NiCr19Fe19NbMo	900-1400	Inconel 718 NiCr19Fe19Nb5Mo3

Bitte beachten Sie die Werkstoffempfehlung auf der jeweiligen Produktseite.
Please take notice of the material recommendations at each catalogpage of the product.

Hinweise zur Ermittlung des effektiven Schneidendurchmessers bei Kugelfräsern auf Seite 430.
Hints for calculation of the effective cutting diameter of ball nose end mills on page 430.

Schnittgeschwindigkeit Cutting speed v_c (m/min)		Fräserdurchmesser Cutting diameter (mm)			
		Vorschub pro Zahn Feed per tooth f_z (mm/z.)			
Hartmetall Carbide		Ø 2-4	Ø 5-10	Ø 11-16	Ø >16
beschichtet coated	unbeschichtet uncoated				
230	185	0,03	0,06	0,09	0,15
200	160	0,025	0,06	0,08	0,14
140	110	0,025	0,05	0,08	0,14
120	95	0,02	0,04	0,07	0,13
140	110	0,03	0,05	0,08	0,14
80	65	0,015	0,035	0,07	0,10
110	90	0,015	0,04	0,06	0,12
100	80	0,015	0,04	0,06	0,12
100	80	0,015	0,04	0,06	0,12
60	50	0,013	0,035	0,05	0,08
80	65	0,013	0,035	0,05	0,08
180	145	0,03	0,07	0,10	0,15
160	130	0,025	0,06	0,09	0,14
150	120	0,02	0,06	0,09	0,14
120	95	0,02	0,06	0,09	0,14
300	240	0,03	0,06	0,10	0,15
1000	800	0,03	0,06	0,10	0,15
250	200	0,025	0,05	0,09	0,14
300	240	0,025	0,05	0,09	0,14
250	200	0,03	0,06	0,10	0,15
350	280	0,025	0,05	0,10	0,15
400	320	0,04	0,08	0,15	0,20
70	55	0,015	0,03	0,05	0,09
40	30	0,01	0,03	0,05	0,09
30	25	0,01	0,03	0,05	0,09
20	15	0,01	0,03	0,05	0,09

Die angegebenen Schnittwerte sind Startwerte und müssen auf die vorhandenen Bedingungen abgestimmt werden.
 The cutting data indicated are starting values and must be adjusted to the prevailing conditions.

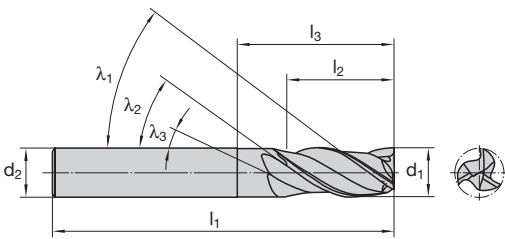

Katalog-Nr. Cat.-No.						1524C		1544C	
P						■		■	
M						■		■	
K						■		■	
N						■		■	
S						■		■	
H									
O									
d ₁	l ₂	l ₁	l ₃	d ₂	z	Ident No.	LMT-Code	Ident No.	LMT-Code
kurz short									
4	5	54	8	6	3	9097465	EM-DHCS 4x5/8 3EA	9097475	EM-DHCS 4x5/8 3EB
5	6	54	10	6	3	9097466	EM-DHCS 5x6/10 3EA	9097476	EM-DHCS 5x6/10 3EB
6	7	54	12	6	3	9097467	EM-DHCS 6x7/12 3EA	9097477	EM-DHCS 6x7/12 3EB
8	9	58	16	8	3	9097468	EM-DHCS 8x9/16 3EA	9097478	EM-DHCS 8x9/16 3EB
10	11	66	20	10	3	9097469	EM-DHCS 10x11/20 3EA	9097479	EM-DHCS 10x11/20 3EB
12	12	73	24	12	3	9097470	EM-DHCS 12x12/24 3EA	9097480	EM-DHCS 12x12/24 3EB
16	16	82	32	16	3	9097472	EM-DHCS 16x16/32 3EA	9097482	EM-DHCS 16x16/32 3EB
20	20	92	40	20	3	9097474	EM-DHCS 20x20/40 3EA	9097484	EM-DHCS 20x20/40 3EB
lang long									
4	8	54	12	6	3	9097445	EM-DHCS 4x8/12 3EA	9097455	EM-DHCS 4x8/12 3EB
5	10	54	15	6	3	9097446	EM-DHCS 5x10/15 3EA	9097456	EM-DHCS 5x10/15 3EB
6	13	57	21	6	3	9097447	EM-DHCS 6x13/21 3EA	9097457	EM-DHCS 6x13/21 3EB
8	19	63	27	8	3	9097448	EM-DHCS 8x19/27 3EA	9097458	EM-DHCS 8x19/27 3EB
10	22	72	32	10	3	9097449	EM-DHCS 10x22/32 3EA	9097459	EM-DHCS 10x22/32 3EB
12	26	83	38	12	3	9097450	EM-DHCS 12x26/38 3EA	9097460	EM-DHCS 12x26/38 3EB
16	32	92	44	16	3	9097452	EM-DHCS 16x32/44 3EA	9097462	EM-DHCS 16x32/44 3EB
20	38	104	54	20	3	9097454	EM-DHCS 20x38/54 3EA	9097464	EM-DHCS 20x38/54 3EB

■ = Hauptanwendung First choice
□ = Nebenanwendung Second choice

Kantenschutzfase Edge protection chamfer	d ₁	b
	4	0,1
	5	0,15
	6-12	0,2
	14-20	0,3

Schnittwertempfehlungen ab Seite 40
Cutting data recommendations starting page 40

DHC SLOT
Untermaßfräser mit ungleichem Drallwinkel
Undersize end mills with uneven helix angle

Fräsen mit Schlitzen aus Vollhartmetall
Milling with solid carbide end mills

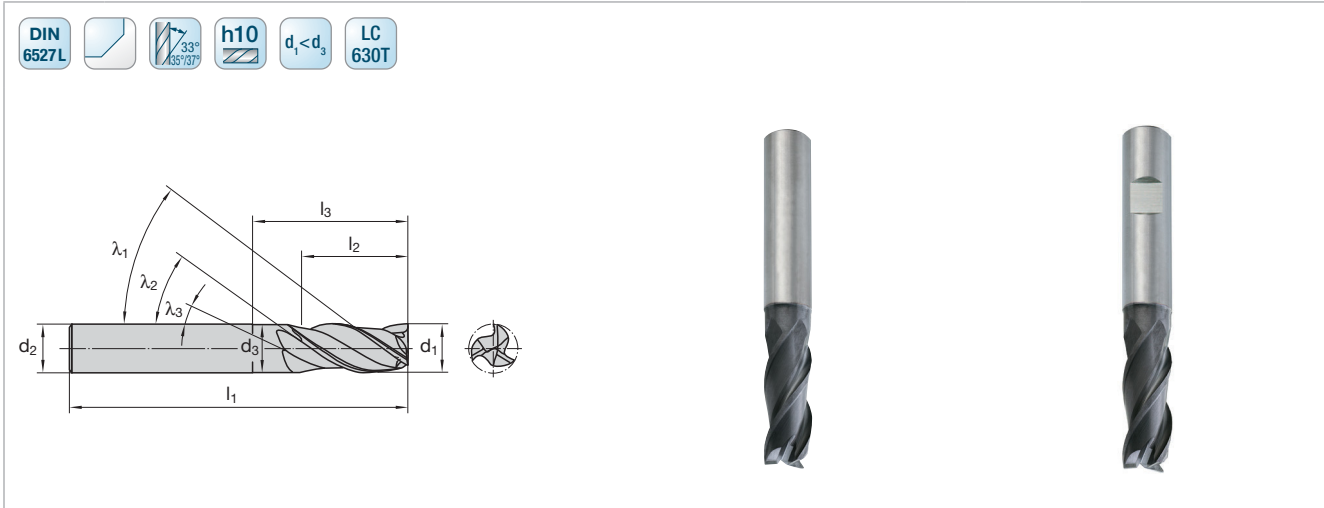

Katalog-Nr. Cat.-No.						1526C		1576C	
P						■		■	
M						■		■	
K						■		■	
N						■		■	
S						■		■	
H									
O									
d ₁	l ₂	l ₁	l ₃	d ₂	z	Ident No.	LMT-Code	Ident No.	LMT-Code
kurz short									
4,8	6	54	18	6	3	9097643	EM-DHCS 4.8x6/18 3EA	9097665	EM-DHCS 4.8x6/18 3EB
5,75	6	54	18	6	3	9097644	EM-DHCS 5.75x6/18 3EA	9097666	EM-DHCS 5.75x6/18 3EB
7,75	9	58	22	8	3	9097645	EM-DHCS 7.75x9/22 3EA	9097667	EM-DHCS 7.75x9/22 3EB
9,7	11	66	26	10	3	9097646	EM-DHCS 9.7x11/26 3EA	9097668	EM-DHCS 9.7x11/26 3EB
11,7	12	73	28	12	3	9097647	EM-DHCS 11.7x12/28 3EA	9097669	EM-DHCS 11.7x12/28 3EB
15,7	16	82	34	16	3	9097659	EM-DHCS 15.7x16/34 3EA	9097671	EM-DHCS 15.7x16/34 3EB

■ = Hauptanwendung First choice
□ = Nebenanwendung Second choice

Kantenschutzfase Edge protection chamfer	d ₁	b
	4,8 – 5,75	0,15
	7,75 – 13,7	0,2
	15,7	0,3

Schnittwertempfehlungen ab Seite 40
Cutting data recommendations starting page 40

DHC SLOT
Schaftfräser mit ungleichem Drallwinkel
End mills with uneven helix angle

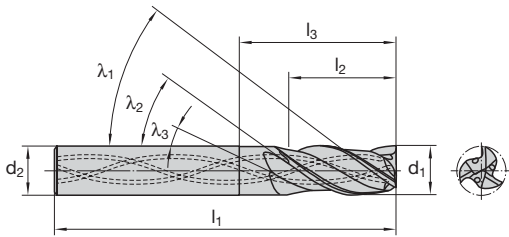

Katalog-Nr. Cat.-No.						1550C	
P						■	
M						■	
K						■	
N						■	
S						■	
H							
O							
d ₁	l ₂	l ₁	l ₃	d ₂	z	Ident No.	LMT-Code
lang long							
6	13	57	21	6	3	9205360	EM-DHCS 6x13/21 3EB-I
8	19	63	27	8	3	9205361	EM-DHCS 8x19/27 3EB-I
10	22	72	32	10	3	9205362	EM-DHCS 10x22/32 3EB-I
12	26	83	38	12	3	9205363	EM-DHCS 12x26/38 3EB-I
16	32	92	44	16	3	9205364	EM-DHCS 16x32/44 3EB-I
20	38	104	54	20	3	9205365	EM-DHCS 20x38/54 3EB-I

■ = Hauptanwendung First choice
 □ = Nebenanwendung Second choice

Kantenschutzfase Edge protection chamfer	d ₁	b
	4	0,1
	5	0,15
	6-12	0,2
	14-20	0,3

Schnittwertempfehlungen ab Seite 40
 Cutting data recommendations starting page 40

Der **DHC SLOT** ist ein 3-schneidiger Fräser. Durch seine großen Spanräume und die sehr gute Spanabfuhr ist er optimal für das Nutenfräsen geeignet. Jede Schneide hat einen anderen Drallwinkel (33°/35°/37°). Neben dem gesamten Spektrum für rost- und säurebeständige Stähle ist der DHC SLOT auch in der gesamten Stahlbearbeitung einsetzbar.

The **DHC SLOT** is a 3-flute end mill. It is ideally suited to slotting work thanks to its large chip spaces and its extremely good chip removal. Each cutting edge has a different helix angle (33°/35°/37°). Besides the entire range for stainless and acid-resistant steels, the DHC SLOT is also suitable for all steel applications.

Der DHC SLOT ist in der Ausführung „kurz“ zusätzlich als **Untermaßfräser** für Passfedernuten mit konischem Schneidenteil sowie in der Ausführung „lang“ mit stirnseitigem Kühlmittelaustritt verfügbar.

The “short” version of the DHC SLOT is also available in **under-size dimensional** with conical cutting for machining keyslots. The “long” version of the DHC SLOT is also available with central coolant supply.

Vorschub-Korrektur-Faktoren f_1
Feed correction factor f_1

$v_f = n \cdot z \cdot f_z \cdot f_1$			
a_e	a_p	DHC lang long	DHC kurz short
		f_1	f_1
$0,1 \cdot d_1$	$1 \times d_1$	1,8	2
	$1,5 \times d_1$	1,7	-
	$2 \times d_1^{1)}$	1,6	-
$0,25 \cdot d_1$	$1 \times d_1$	1,4	2
	$1,5 \times d_1$	1,3	-
	$2 \times d_1^{1)}$	1,2	-
$0,5 \cdot d_1$	$1 \times d_1$	1,1	1,3
	$1,5 \times d_1$	1	-
	$2 \times d_1^{1)}$	0,8	-
$0,75 \cdot d_1$	$1 \times d_1$	0,8	1
	$1,5 \times d_1$	0,7	-
	$2 \times d_1$	0,6	-
$1 \cdot d_1$	$0,5 \times d_1$	0,8	0,9
	$1 \times d_1$	0,7	0,8
	$1,5 \times d_1$	0,6	-

Schnittgeschwindigkeit v_c ist um 30 % zu erhöhen
 The cutting speed v_c must be increased by 30 %

¹⁾ $1,8 \times d_1$ für Durchmesser 14, 18, 20
 1.8 x d_1 for diameter 14, 18, 20

Schnittgeschwindigkeit v_c ist um 20 % zu reduzieren
 Reduce the cutting speed v_c by 20 %



- a_e = Schnittbreite in mm
Width of cut in mm
- a_p = Schnitttiefe in mm
Depth of cut in mm
- d_1 = Durchmesser in mm
Cutter diameter in mm
- f_1 = Korrekturfaktor für v_f
Correction factor for v_f
- f_z = Vorschub pro Zahn in mm
Feed per tooth in mm
- n = Drehzahl in min^{-1}
Speed in min^{-1}
- v_f = Vorschubgeschwindigkeit in mm/min
Feed rate in mm/min
- z = Anzahl der Schneiden
No. of teeth

DHC SLOT
Schnittwertempfehlungen für Schafffräser
Cutting data recommendations for end mills

	Werkstoff	Material	Werkstoff-Nr. Material No.	DIN Bezeichnung Alt DIN Description Old	R_m/UTS (N/mm²)	DIN Bezeichnung Neu DIN Description New
P	Unlegierter Baustahl + Automatenstahl	Plain carbon steel + free cutting steel	1.0570	St52-3	-700	S355J2G3
			1.1730	C45	-800	C45U
			1.0715	9SMn28	-700	11SMn30
			1.1191	Ck45	500-950	C45E
			1.7219	26CrMo4		26CrMo4-2
	Vergütungsstahl, mittelfest	Heat-treatment steel, medium strength	1.7225	42CrMo4	500-950	42CrMo4
			1.8159	51CrV4		51CrV4
	Stahlguss	Cast steel	1.0416	GS40	-950	GS40
	Einsatzstahl	Case hardening steel	1.7131	16MnCr5	-950	16MnCr5
	Rost- und säurebe- ständiger Stahl, ferritisch, martensitisch	Stainless steel, ferritic, martensitic	1.4006	X10Cr13	500-950	X12Cr13
			1.4104	X12CrMoS17		X14CrMoS17
			1.4122	X35CrMo17		X39CrMo17-1
	Vergütungsstahl, hochfest	Heat-treatment steel, high strength	1.7225	42CrMo4	950-1400	42CrMo4
		1.6580	30CrNiMo8		30CrNiMo8	
Nitrierstahl, vergütet	Nitriding steel, heat treated	1.8504	34CrAl6	950-1400	34CrAl6	
		1.2344	X40CrMoV5.1	-900	X40CrMoV5-1	
Werkzeugstahl	Tool steel	1.2343	X38CrMoV5 1	950-1400	X37CrMoV5-1	
		1.2379	X155CrVMo12 1	-950	X153CrMoV12-1	
		1.2316	X38CrMo16	-1100	X38CrMo16	
		1.2358	60CrMoV18-5	850-1000	60CrMoV18-5	
		1.2080	X210Cr12	950-1400	X210Cr12	
		1.2714	55NiCrMoV7	1100-1350	55NiCrMoV7	
		1.2311	40CrMnMo7	-1100	40CrMnMo7	
		1.2312	40CrMnNiMoS8.6	-1150	40CrMnNiMoS8-6	
		1.2738	45CrMnNiMo8.6.4	950-1150	45CrMnNiMo8-6-4	
M	Rost- und säurebe- ständiger Stahl, austenitisch	Stainless steel, austenitic	1.4301	X2CrNiMo17-12-2	500-950	X5CrNiMo18-10
			1.4404	X6CrNiMoTi17-12-2		X2CrNiMo17-12-2
			1.4571	X10CrNiMoTi18		X10CrNiMoTi18
Rost- und säurebe- ständiger Stahl, martensitisch aushärtbar	Stainless steel, martensitic steel	1.2709	X3NiCoMoTi18-9-5	800-1000	X3NiCoMoTi18-9-5	
		1.4542	X5CrNiCuNb16-4		X5CrNiCuNb16-4	
		1.4568	X7CrNiAl17-7		X7CrNiAl17-7	
K	Grauguss	Grey cast iron	0.6025	GG25	100-400 (120-260 HB)	EN-GJl-250
	Legierter Grauguss	Alloyed grey cast iron	0.6678	GGL-NiCr35 2	150-250 (160-230 HB)	EN-GJLA-XNiCr35-2
	Sphäroguss	Nodular cast iron	0.7060	GGG60	400-800	EN-GJS-600-3
			0.7070	GGG70L	(120-310 HB)	EN-GJS-700-2U
Temperguss	Malleable cast iron	0.8155	GTS55	350-700 (150-280 HB)	EN-GJMB-550-4	
N	Aluminium-Legierungen, kurzspanend	Aluminium alloys, short chipping	3.2581	G-AlSi12	-400	G-IGK-AlSi12
	Kupfer-Legierungen, kurzspanend	Copper alloys, short chipping	2.0402	MS58	-500	CuZn40Pb2
S	Titan-Legierungen, mittelfest	Titanium alloys, medium strength	3.7115	TiAl5Sn2,5	-950	TiAl5Sn2-5
			3.7164	TiAl6V4		Ti6AlV4
	Titan-Legierungen, hochfest	Titanium alloys, high strength	3.7174	TiAl6Sn2	900-1400	TiAl6V6Sn2
	Nickelbasis-Legierungen, mittelfest	Nickel based alloys, medium strength	2.4670	NiCr12Al6MoNb	-950	NiCr12Al6MoNb
Nickelbasis-Legierungen, hochwarmfest	Heat resistant nickel based alloys, high strength	2.4668	NiCr19Fe19NbMo	900-1400	Inconel 718 NiCr19Fe19Nb5Mo3	

Die angegebenen Schnittwerte sind Startwerte und müssen auf die vorhandenen Bedingungen abgestimmt werden.
The cutting data indicated are starting values and must be adjusted to the prevailing conditions.

Vorschub-Korrektur-Faktoren f_1 siehe Seite 62
Feed correction factor f_1 see page 62

Schnitt- geschwindigkeit Cutting speed v_c (m/min)	Kühlung Coolant	Fräserdurchmesser Cutting diameter (mm)							
		Vorschub pro Zahn Feed per tooth f_z (mm/z.)							
		4	5	6	8	10	12	14-16	18-20
230		0,04	0,06	0,07	0,09	0,11	0,13	0,18	0,22
230		0,04	0,06	0,07	0,09	0,11	0,13	0,18	0,22
200		0,04	0,05	0,06	0,08	0,10	0,12	0,16	0,20
160		0,04	0,05	0,06	0,08	0,10	0,12	0,16	0,20
130		0,03	0,04	0,05	0,07	0,09	0,10	0,14	0,17
160		0,04	0,05	0,06	0,08	0,10	0,12	0,16	0,20
140		0,03	0,04	0,05	0,06	0,08	0,09	0,12	0,15
120		0,03	0,04	0,05	0,06	0,08	0,09	0,12	0,15
110		0,03	0,04	0,05	0,06	0,08	0,09	0,12	0,15
100		0,03	0,04	0,04	0,06	0,07	0,08	0,11	0,14
100		0,02	0,03	0,03	0,04	0,05	0,06	0,08	0,10
120		0,03	0,03	0,04	0,05	0,07	0,08	0,10	0,13
180		0,06	0,07	0,08	0,11	0,14	0,17	0,22	0,28
160		0,05	0,06	0,07	0,10	0,12	0,14	0,19	0,24
150		0,04	0,06	0,07	0,09	0,11	0,13	0,18	0,22
120		0,04	0,06	0,07	0,09	0,11	0,13	0,18	0,22
300		0,05	0,06	0,08	0,10	0,13	0,15	0,20	0,25
250		0,04	0,05	0,06	0,08	0,10	0,12	0,16	0,20
80		0,03	0,03	0,04	0,05	0,07	0,08	0,10	0,13
60		0,02	0,03	0,03	0,04	0,05	0,06	0,08	0,10
40		0,03	0,03	0,04	0,05	0,07	0,08	0,10	0,13
30		0,02	0,03	0,03	0,04	0,05	0,06	0,08	0,10

Trockenbearbeitung, Pressluftkühlung ist vorteilhaft
 Dry machining, air-blast cooling is advantageous

Nassbearbeitung, auf ausreichende Emulsionszuführung achten
 Wet machining, sufficient emulsion volume required

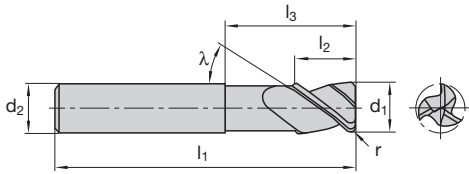

Katalog-Nr. Cat.-No.							1410C		
P								<input checked="" type="checkbox"/>	
M								<input type="checkbox"/>	
K								<input checked="" type="checkbox"/>	
N								<input type="checkbox"/>	
S								<input type="checkbox"/>	
H								<input type="checkbox"/>	
O								<input type="checkbox"/>	
d ₁	l ₂	l ₁	l ₃	d ₂	z	r	Ident No.	LMT-Code	
kurz short									
1	1,5	38	2,7	3	2	0,2	1122314	EM-HSCN 1x1.5/2.7 2R0.2A	
2	2	50	3,6	6	2	0,3	1122326	EM-HSCN 2x2/3.6 2R0.3A	
3	3	50	5,5	6	2	0,4	1122338	EM-HSCN 3x3/5.5 2R0.4A	
4	4	57	14,5	6	2	0,5	1122350	EM-HSCN 4x4/14.5 2R0.5A	
4	4	57	14,5	6	2	1	1110039	EM-HSCN 4x4/14.5 2R1A	
5	5	57	21	6	2	0,6	1122362	EM-HSCN 5x5/21 2R0.6A	
6	6	57	21	6	2	0,8	1122374	EM-HSCN 6x6/21 2R0.8A	
6	6	57	21	6	2	1	1110044	EM-HSCN 6x6/21 2R1A	
6	6	57	21	6	2	0,3	1110188	EM-HSCN 6x6/21 2R0.3A	
6	6	57	21	6	2	0,5	1110042	EM-HSCN 6x6/21 2R0.5A	
8	8	63	27	8	3	0,3	1110190	EM-HSCN 8x8/27 3R0.3A	
8	8	63	27	8	3	1	1122386	EM-HSCN 8x8/27 3R1A	
8	8	63	27	8	3	2	1110046	EM-HSCN 8x8/27 3R2A	
10	10	72	32	10	3	2	1110049	EM-HSCN 10x10/32 3R2A	
10	10	72	32	10	3	0,5	1110192	EM-HSCN 10x10/32 3R0.5A	
10	10	72	32	10	3	1	1110047	EM-HSCN 10x10/32 3R1A	
10	10	72	32	10	3	1,25	1122398	EM-HSCN 10x10/32 3R1.25A	
12	12	83	38	12	3	1	1110050	EM-HSCN 12x12/38 3R1A	
12	12	83	38	12	3	1,6	1122411	EM-HSCN 12x12/38 3R1.6A	
12	12	83	38	12	3	2	1110053	EM-HSCN 12x12/38 3R2A	

Schnittwertempfehlungen ab Seite 44
 Cutting data recommendations starting page 44

■ = Hauptanwendung First choice
 □ = Nebenanwendung Second choice



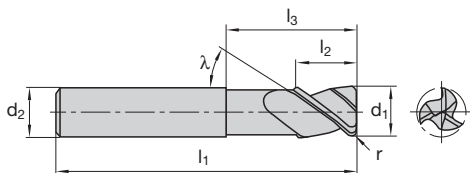

Katalog-Nr. Cat.-No.							1410C		
P								<input checked="" type="checkbox"/>	
M								<input type="checkbox"/>	
K								<input checked="" type="checkbox"/>	
N								<input type="checkbox"/>	
S								<input type="checkbox"/>	
H								<input type="checkbox"/>	
O								<input type="checkbox"/>	
d ₁	l ₂	l ₁	l ₃	d ₂	z	r	Ident No.	LMT-Code	
lang long									
2	2	70	17	6	2	0,3	1122673	EM-HSCN 2x2/17 2R0.3A	
3	3	70	18	6	2	0,4	1122685	EM-HSCN 3x3/18 2R0.4A	
5	5	80	44	6	2	0,6	1122014	EM-HSCN 5x5/44 2R0.6A	
5	5	80	44	6	2	1	1110056	EM-HSCN 5x5/44 2R1A	
6	6	80	44	6	2	1	1110058	EM-HSCN 6x6/44 2R1A	
6	6	80	44	6	2	0,3	1110189	EM-HSCN 6x6/44 2R0.3A	
6	6	80	44	6	2	0,5	1110057	EM-HSCN 6x6/44 2R0.5A	
6	6	80	44	6	2	0,8	1122027	EM-HSCN 6x6/44 2R0.8A	
8	8	90	54	8	3	0,3	1110191	EM-HSCN 8x8/54 3R0.3A	
8	8	90	54	8	3	1	1122040	EM-HSCN 8x8/54 3R1A	
8	8	90	54	8	3	1,5	1110059	EM-HSCN 8x8/54 3R1.5A	
10	10	100	60	10	3	2	1110064	EM-HSCN 10x10/60 3R2A	
10	10	100	60	10	3	1	1110062	EM-HSCN 10x10/60 3R1A	
10	10	100	60	10	3	1,3	1122053	EM-HSCN 10x10/60 3R1.3A	
12	12	110	65	12	3	1	1110065	EM-HSCN 12x12/65 3R1A	
16	16	130	82	16	4	2	1122080	EM-HSCN 16x16/82 4R2A	

Schnittwertempfehlungen ab Seite 44
 Cutting data recommendations starting page 44

■ = Hauptanwendung First choice
 □ = Nebenanwendung Second choice

HScline N

Schnittwertempfehlungen für Schafffräser mit Eckenradius und runder Stirn

Cutting data recommendations for end mills corner radius or ball nose

	Werkstoff	Material	Werkstoff-Nr. Material No.	DIN Bezeichnung Alt DIN Description Old	R _m /UTS (N/mm ²)	DIN Bezeichnung Neu DIN Description New
P	Unlegierter Baustahl + Automatenstahl	Plain carbon steel + free cutting steel	1.0570	St52-3	-700	S355J2G3
			1.1730	C45	-800	C45U
			1.0715	9SMn28	-700	11SMn30
			1.1191	Ck45	500-950	C45E
	Vergütungsstahl, mittelfest	Heat-treatment steel, medium strength	1.7225	42CrMo4	500-950	42CrMo4
			1.8159	51CrV4		51CrV4
	Stahlguss	Cast steel	1.0416	GS40	-950	GS40
	Einsatzstahl	Case hardening steel	1.7131	16MnCr5	-950	16MnCr5
	Rost- und säurebe- ständiger Stahl, ferritisch, martensitisch	Stainless steel, ferritic, martensitic	1.4006	X10Cr13	500-950	X12Cr13
			1.4104	X12CrMoS17		X14CrMoS17
			1.4122	X35CrMo17		X39CrMo17-1
	Vergütungsstahl, hochfest	Heat-treatment steel, high strength	1.7225	42CrMo4	950-1400	42CrMo4
	Nitrierstahl, vergütet	Nitriding steel, heat treated	1.6580	30CrNiMo8		30CrNiMo8
			1.8504	34CrAl6	950-1400	34CrAl6
	Werkzeugstahl	Tool steel	1.2344	X40CrMoV5.1	-900	X40CrMoV5-1
			1.2343	X38CrMoV5 1	950-1400	X37CrMoV5-1
1.2316			X38CrMo16	-1100	X38CrMo16	
1.2379			X155CrVMo12 1	-950	X153CrMoV12-1	
1.2080			X210Cr12	950-1400	X210Cr12	
1.2358			60CrMoV18-5	850-1000	60CrMoV18-5	
1.2714			55NiCrMoV7	1100-1350	55NiCrMoV7	
1.2311			40CrMnMo7	-1100	40CrMnMo7	
1.2312			40CrMnNiMoS8.6	-1150	40CrMnNiMoS8-6	
1.2738			45CrMnNiMo8.6.4	950-1150	45CrMnNiMo8-6-4	
M	Rost- und säurebe- ständiger Stahl, austenitisch	Stainless steel, austenitic	1.4301	X2CrNiMo17-12-2	500-950	X5CrNiMo18-10
			1.4404	X6CrNiMoTi17-12-2		X2CrNiMo17-12-2
			1.4571	X10CrNiMoTi18	500-950	X10CrNiMoTi18
	Rost- und säurebe- ständiger Stahl, martensitisch aushärtbar	Stainless steel, martensitic steel	1.2709	X3NiCoMoTi18-9-5	800-1000	X3NiCoMoTi18-9-5
1.4542			X5CrNiCuNb16-4		X5CrNiCuNb16-4	
1.4568			X7CrNiAl17-7		X7CrNiAl17-7	
K	Grauguss	Grey cast iron	0.6025	GG25	100-400 (120-260 HB)	EN-GJ1-250
	Legierter Grauguss	Alloyed grey cast iron	0.6678	GGL-NiCr35 2	150-250 (160-230 HB)	EN-GJLA-XNiCr35-2
	Sphäroguss	Nodular cast iron	0.7070	GGG70L	400-800	EN-GJS-700-2U
			0.7060	GGG60	(120-310 HB)	EN-GJS-600-3
Temperguss	Malleable cast iron	0.8155	GTS55	350-700 (150-280 HB)	EN-GJMB-550-4	
N	Aluminium-Legierungen, kurzspanend	Aluminium alloys, short chipping	3.2581	G-AlSi12	-400	G-IGK-AlSi12
	Aluminium-Legierungen, langspanend	Aluminium alloys, long chipping	3.3535	AlMg3	-550	AlMg3
			3.4365	AlZnMgCu1,5		AlZnMgCu1,5
	Kupfer-Legierungen, kurzspanend	Copper alloys, short chipping	2.0402	MS58	-500	CuZn40Pb2
	Kupfer-Legierungen, langspanend	Copper alloys, long chipping	2.0320	MS63	300-500	CuZn37
			2.0975	CuAl10Ni		CuAl10Fe5Ni5-C
	Thermoplaste	Thermoplastics		PVC	40-70	PVC
Duroplaste	Duroplastics		Bakelit, Melamin	20-40	Bakelit, Melamin	
Graphit	Graphite					
S	Titan-Legierungen, mittelfest	Titanium alloys, medium strength	3.7115	TiAl5Sn2,5	-950	TiAl5Sn2-5
			3.7164	TiAl6V4		Ti6AlV4
	Titan-Legierungen, hochfest	Titanium alloys, high strength	3.7174	TiAl6Sn2	900-1400	TiAl6V6Sn2
	Nickelbasis-Legierungen, mittelfest	Nickel based alloys, medium strength	2.4670	NiCr12Al6MoNb	-950	NiCr12Al6MoNb
Nickelbasis-Legierungen, hochwarmfest	Heat resistant nickel based alloys, high strength	2.4668	NiCr19Fe19NbMo	900-1400	Inconel 718 NiCr19Fe19Nb5Mo3	
H	Hartguss	Chilled cast iron		Ni-hard, Ampco	300-600 HB	Ni-hard, Ampco
	Gehärteter Stahl	Hardened steel			45-52 HRC	

Schnitt- geschwindigkeit Cutting speed v_c (m/min)	Fräserdurchmesser Cutting diameter (mm)			
	Vorschub pro Zahn Feed per tooth f_z (mm/z.)			
	Schlichten Finishing			
1410C	Ø 1-4	Ø 5-8	Ø 10-12	Ø 14-20
600	0,05	0,10	0,12	0,15
600	0,05	0,10	0,12	0,15
600	0,05	0,10	0,12	0,15
450	0,04	0,07	0,10	0,13
450	0,03	0,07	0,10	0,13
400	0,015	0,04	0,08	0,12
300	0,015	0,04	0,08	0,12
350	0,03	0,06	0,09	0,13
300	0,02	0,05	0,07	0,01
250	0,03	0,06	0,90	0,12
220				
230	0,03	0,06	0,90	0,12
250	0,04	0,07	0,10	0,13
230	0,03	0,065	0,085	0,11
180	0,04	0,07	0,10	0,13
600	0,04	0,07	0,10	0,13
500	0,04	0,07	0,10	0,14
500	0,02	0,06	0,07	0,09
350	0,02	0,06	0,07	0,09
300	0,02	0,06	0,07	0,09
800	0,04	0,08	0,10	0,12
1000	0,04	0,08	0,10	0,12
700	0,04	0,08	0,10	0,12
1000	0,04	0,08	0,10	0,12
600	0,05	0,10	0,12	0,15
700	0,04	0,08	0,10	0,12
1000	0,04	0,07	0,10	0,14
120	0,02	0,06	0,07	0,09
80	0,015	0,05	0,06	0,08
100	0,02	0,06	0,07	0,09
60	0,015	0,05	0,06	0,08
50-70	0,025	0,045	0,055	0,075
160-200	0,025	0,045	0,055	0,075

Die angegebenen Schnittwerte sind Startwerte und müssen auf die vorhandenen Bedingungen abgestimmt werden.

The cutting data indicated are starting values based and must be adjusted to the prevailing conditions.

Hinweise zur Ermittlung des effektiven Schneidendurchmessers bei Kugelfräsern auf Seite 99.

Hints for calculation of the effective cutting diameter of ball nose end mills on page 99.

Merkmale:

- Torische Schneidengeometrie
- Zwei effektive Schneiden
- Kleinster Schnittkreisdurchmesser von 1 mm bzw. 2 mm, somit keine Schnittgeschwindigkeit von „0“ im Zentrum
- Erhältlich in den Ausführungen kurz, lang (Schneidentoleranz h10) und lang mit verstärktem Schaft (Schneidentoleranz h7)
- Durchmesserbereich von 4 mm bis 12 mm

Vorteile:

- Geringere Wärmeentwicklung im Zentrum
- Weniger Verschleiß im Zentrum
- Höhere Standzeit
- Geringere Fräszeiten
- Kleineres Restmaterial im Boden/Wand-Bereich gegenüber Kugel
- Schlichten von ebenen Bereichen mit erhöhter Zustellbreite gegenüber Kugelwerkzeug
- Größerer Zeilensprung beim Schlichten von ebenen Bereichen bei gleicher Oberflächenqualität

Features:

- Toroidal cutter geometry
- Two effective cutting edges
- Smallest cutting circle diameter is 1mm or 2 mm, therefore no “zero” cutting speed in the centre
- Available in short and long (tolerance h10) versions, and long with reinforced shank (tolerance h7)
- Diameters ranging from 4 mm to 12 mm

Advantages:

- Reduced heat generation in the centre
- Less wear in the centre
- Longer tool life
- Reduced cutting times
- Less residual material in the floor/wall region than ball nose cutters
- Finishing plane regions with greater cut width than ball nose cutter
- Larger step over with the same surface quality when machining flat areas



Vorteile Fräser mit verstärktem Schaft:

- Größere Gesamtlänge – somit einsetzbar in tieferen Bauteilen
- Eingegengte Durchmesser-toleranz h7
- Höhere Stabilität

Advantages of end mills with reinforced shank:

- Greater total length – can therefore be used in deeper workpieces
- Tightened tolerance h7 on diameter
- Greater stability



Weitere Informationen zur Geometrie des FlatBall® finden Sie auf Seite 49.
Further information about the geometry of the FlatBall® see page 49.

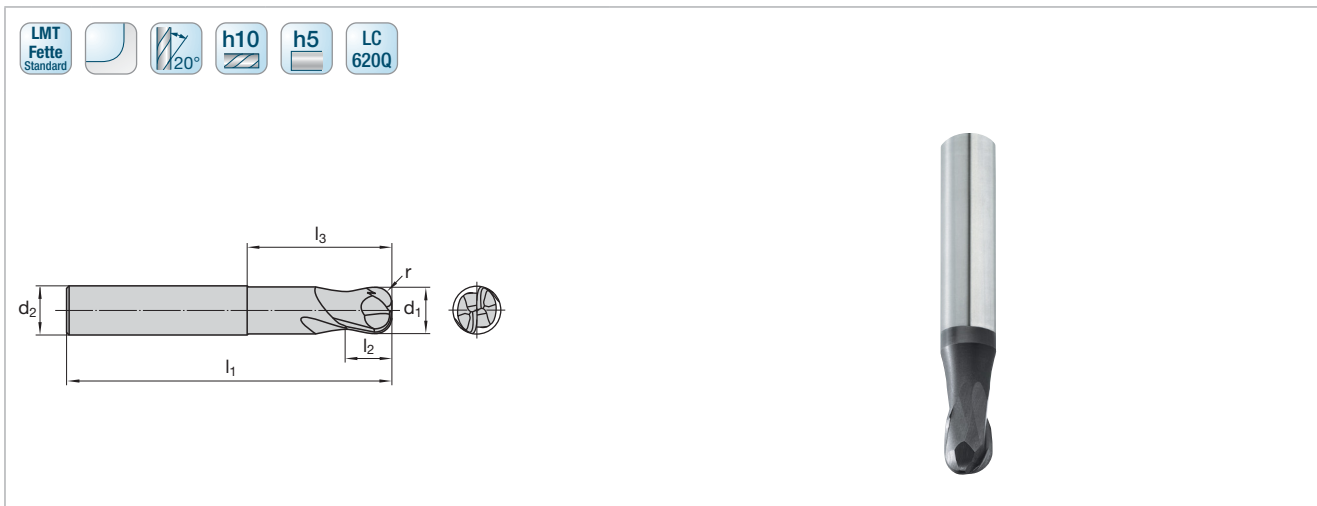

Katalog-Nr. Cat.-No.								1400C	
P								<input checked="" type="checkbox"/>	
M								<input type="checkbox"/>	
K								<input checked="" type="checkbox"/>	
N								<input type="checkbox"/>	
S								<input type="checkbox"/>	
H								<input type="checkbox"/>	
O								<input type="checkbox"/>	
d ₁	l ₂	l ₁	l ₃	d ₂	z	r (±0,01)	Ident No.	LMT-Code	
kurz short									
4	4	57	14	6	2	1,5	9123725	EM-FB 4x4/14 2R1.5A	
5	5	57	17	6	2	2	9123726	EM-FB 5x5/17 2R2A	
6	6	57	21	6	2	2	9123727	EM-FB 6x6/21 2R2A	
8	8	63	27	8	2	3	9123728	EM-FB 8x8/27 2R3A	
10	10	72	32	10	2	4	9123729	EM-FB 10x10/32 2R4A	
12	12	83	38	12	2	5	9123730	EM-FB 12x12/38 2R5A	
lang long									
6	6	80	44	6	2	2	9123785	EM-FB 6x6/44 2R2A	
8	8	90	54	8	2	3	9123787	EM-FB 8x8/54 2R3A	
10	10	100	60	10	2	4	9123788	EM-FB 10x10/60 2R4A	
12	12	110	65	12	2	5	9123790	EM-FB 12x12/65 2R5A	
lang verstärkt long reinforced									
6 ¹⁾	6	90	27	8	2	2	9123794	EM-FB 6x6/27 2R2A	
8 ¹⁾	8	100	32	10	2	3	9123795	EM-FB 8x8/32 2R3A	
10 ¹⁾	10	110	35	12	2	4	9123796	EM-FB 10x10/35 2R4A	
12 ¹⁾	12	130	37	16	2	5	9123797	EM-FB 12x12/37 2R5A	

¹⁾ Toleranz h7
Tolerance h7

Schnittwertempfehlungen ab Seite 48
Cutting data recommendations starting page 48

= Hauptanwendung First choice
 = Nebenanwendung Second choice

FlatBall® HSC
Schnittwertempfehlungen für Schafffräser
Cutting data recommendations for end mills

	Werkstoff	Material	Werkstoff-Nr. Material No.	DIN Bezeichnung Alt DIN Description Old	R_m/UTS (N/mm²)	DIN Bezeichnung Neu DIN Description New
P	Unlegierter Baustahl + Automatenstahl	Plain carbon steel + free cutting steel	1.0570	St52-3	-700	S355J2G3
			1.1730	C45	-800	C45U
			1.0715	9SMn28	-700	11SMn30
	Vergütungsstahl, mittelfest	Heat-treatment steel, medium strength	1.1191	Ck45	500-950	C45E
			1.7219	26CrMo4		26CrMo4-2
	Stahlguss	Cast steel	1.7225	42CrMo4	500-950	42CrMo4
			1.8159	51CrV4		51CrV4
	Einsatzstahl	Case hardening steel	1.0416	GS40	-950	GS40
			1.7131	16MnCr5	-950	16MnCr5
	Rost- und säurebe- ständiger Stahl, ferritisch, martensitisch	Stainless steel, ferritic, martensitic	1.4006	X10Cr13	500-950	X12Cr13
			1.4104	X12CrMoS17		X14CrMoS17
			1.4122	X35CrMo17		X39CrMo17-1
	Vergütungsstahl, hochfest	Heat-treatment steel, high strength	1.7225	42CrMo4	950-1400	42CrMo4
			1.6580	30CrNiMo8		30CrNiMo8
	Nitrierstahl, vergütet	Nitriding steel, heat treated	1.8504	34CrAl6	950-1400	34CrAl6
			1.2344	X40CrMoV5.1	-900	X40CrMoV5-1
	Werkzeugstahl	Tool steel	1.2343	X38CrMoV5 1	950-1400	X37CrMoV5-1
			1.2316	X38CrMo16	-1100	X38CrMo16
			1.2379	X155CrVMo12 1	-950	X153CrMoV12-1
			1.2080	X210Cr12	950-1400	X210Cr12
1.2358			60CrMoV18-5	850-1000	60CrMoV18-5	
1.2714			55NiCrMoV7	1100-1350	55NiCrMoV7	
1.2311			40CrMnMo7	-1100	40CrMnMo7	
1.2312			40CrMnNiMoS8.6	-1150	40CrMnNiMoS8-6	
1.2738	45CrMnNiMo8.6.4	950-1150	42CrMo4			
M	Rost- und säurebe- ständiger Stahl, austenitisch	Stainless steel, austenitic	1.4301	X2CrNiMo17-12-2	500-950	X5CrNiMo18-10
			1.4404	X6CrNiMoTi17-12-2		X2CrNiMo17-12-2
			1.4571	X10CrNiMoTi18	500-950	X10CrNiMoTi18
	Rost- und säurebe- ständiger Stahl, martensitisch aushärtbar	Stainless steel, martensitic steel	1.2709	X3NiCoMoTi18-9-5	800-1000	X3NiCoMoTi18-9-5
1.4542			X5CrNiCuNb16-4		X5CrNiCuNb16-4	
1.4568	X7CrNiAl17-7		X7CrNiAl17-7			
K	Grauguss	Grey cast iron	0.6025	GG25	100-400 (120-260 HB)	EN-GJL-250
			0.6678	GGL-NiCr35 2	150-250 (160-230 HB)	EN-GJLA-XNiCr35-2
	Sphäroguss	Nodular cast iron	0.7060	GGG60	400-800	EN-GJS-600-3
			0.7070	GGG70L	(120-310 HB)	EN-GJS-700-2U
Temperguss	Malleable cast iron	0.8155	GTS55	350-700 (150-280 HB)	EN-GJMB-550-4	
N	Aluminium-Legierungen, kurzspanend	Aluminium alloys, short chipping	3.2581	G-AISi12	-400	G-IGK-AISi12
	Aluminium-Legierungen, langspanend	Aluminium alloys, long chipping	3.3535	AlMg3	-550	AlMg3
			3.4365	AlZnMgCu1,5		AlZnMgCu1,5
	Kupfer-Legierungen, kurzspanend	Copper alloys, short chipping	2.0402	MS58	-500	CuZn40Pb2
	Kupfer-Legierungen, langspanend	Copper alloys, long chipping	2.0320	MS63	300-500	CuZn37
			2.0975	CuAl10Ni		CuAl10Fe5Ni5-C
	Thermoplaste	Thermoplastics		PVC	40-70	PVC
Duroplaste	Duroplastics		Bakelit, Melamin	20-40	Bakelit, Melamin	
S	Titan-Legierungen, mittelfest	Titanium alloys, medium strength	3.7115	TiAl5Sn2,5	-950	TiAl5Sn2-5
			3.7164	TiAl6V4		Ti6AlV4
	Titan-Legierungen, hochfest	Titanium alloys, high strength	3.7174	TiAl6Sn2	900-1400	TiAl6V6Sn2
	Nickelbasis-Legierungen, mittelfest	Nickel based alloys, medium strength	2.4670	NiCr12Al6MoNb	-950	NiCr12Al6MoNb
	Nickelbasis-Legierungen, hochwarmfest	Heat resistant nickel based alloys, high strength	2.4668	NiCr19Fe19NbMo	900-1400	Inconel 718 NiCr19Fe19Nb5Mo3
H	Hartguss	Chilled cast iron		Ni-hard, Ampco	300-600 HB	Ni-hard, Ampco
	Gehärteter Stahl	Hardened steel			45-52 HRC	
					53-59 HRC	
					60-65 HRC	

Die angegebenen Schnittwerte sind Startwerte und müssen auf die vorhandenen Bedingungen abgestimmt werden.
The cutting data indicated are starting values based and must be adjusted to the prevailing conditions.

	Schnitt- geschwindigkeit Cutting speed v_c (m/min)	Fräserdurchmesser Cutting diameter (mm)	
		Vorschub pro Zahn Feed per tooth f_z (mm/z.)	
		Ø 4–8	Ø 10–12
	1400C		
	300	0,12	0,18
	250	0,10	0,16
	150	0,06	0,12
	180	0,10	0,16
	160	0,10	0,16
	160	0,10	0,16
	180	0,07	0,12
	220	0,08	0,13
	160	0,10	0,15
	160	0,08	0,13
	230	0,05	0,09
	220	0,04	0,08
	180	0,05	0,09
	180	0,10	0,17
	160	0,08	0,15
	150	0,06	0,12
	130	0,06	0,12
	300	0,06	0,12
	1000	0,06	0,12
	200	0,06	0,12
	250	0,06	0,12
	300	0,06	0,12
	300	0,06	0,12
	300	0,07	0,13
	70	0,04	0,09
	30	0,03	0,07
	40	0,04	0,09
	30	0,03	0,07
	60	0,04	0,09
	220	0,05	0,10
	160	0,045	0,095
	120	0,04	0,09

Planfräsen Face milling

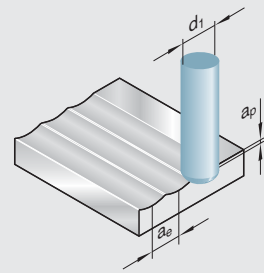

$$a_e = d_1 - 2 \cdot r$$

$$a_p < 0,025 \cdot d_1$$

Kopierschichten Profile finishing

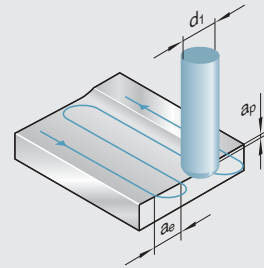

$$a_e = 0,5 \cdot (d_1 - 2 \cdot r)$$

$$a_p = 0,02 \cdot d_1$$

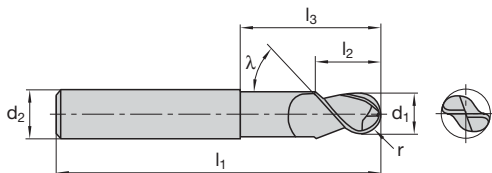

Katalog-Nr. Cat.-No.							1412C		
P								<input checked="" type="checkbox"/>	
M								<input type="checkbox"/>	
K								<input checked="" type="checkbox"/>	
N								<input type="checkbox"/>	
S								<input type="checkbox"/>	
H								<input type="checkbox"/>	
O								<input type="checkbox"/>	
d ₁	l ₂	l ₁	l ₃	d ₂	z	r	Ident No.	LMT-Code	
kurz short									
1	1,5	38	2,7	3	2	0,5	1122452	EM-HSCN 1x1.5/2.7 2BA	
2	2	50	3,6	6	2	1	1122464	EM-HSCN 2x2/3.6 2BA	
3	3	50	5,5	6	2	1,5	1122477	EM-HSCN 3x3/5.5 2BA	
4	4	57	14,5	6	2	2	1122490	EM-HSCN 4x4/14.5 2BA	
5	5	57	21	6	2	2,5	1122502	EM-HSCN 5x5/21 2BA	
6	6	57	21	6	2	3	1122526	EM-HSCN 6x6/21 2BA	
8	8	63	27	8	2	4	1122538	EM-HSCN 8x8/27 2BA	
10	10	72	32	10	2	5	1122550	EM-HSCN 10x10/32 2BA	
12	12	83	38	12	2	6	1122562	EM-HSCN 12x12/38 2BA	
16	16	92	44	16	4	8	1122574	EM-HSCN 16x16/44 4BA	
20	20	104	54	20	4	10	1122587	EM-HSCN 20x20/54 4BA	
lang long									
2	2	70	17	6	2	1	1300377	EM-HSCN 2x2/17 2BA	
3	3	70	18	6	2	1,5	1300378	EM-HSCN 3x3/18 2BA	
4	4	80	19	6	2	2	1300379	EM-HSCN 4x4/19 2BA	
5	5	80	44	6	2	2,5	1300380	EM-HSCN 5x5/44 2BA	
6	6	80	44	6	2	3	1300381	EM-HSCN 6x6/44 2BA	
8	8	90	54	8	2	4	1300382	EM-HSCN 8x8/54 2BA	
10	10	100	60	10	2	5	1300384	EM-HSCN 10x10/60 2BA	
12	12	110	65	12	2	6	1300385	EM-HSCN 12x12/65 2BA	
16	16	130	82	16	4	8	1300386	EM-HSCN 16x16/82 4BA	

Schnittwertempfehlungen ab Seite 52
Cutting data recommendations starting page 52

■ = Hauptanwendung First choice
□ = Nebenanwendung Second choice



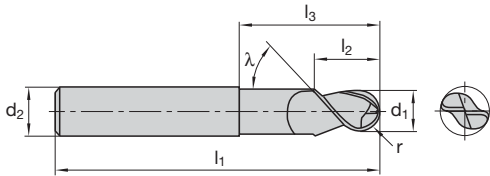

Katalog-Nr. Cat.-No.							1412C	
P								■
M								□
K								■
N								□
S								□
H								□
O								□
d ₁	l ₂	l ₁	l ₃	d ₂	z	r	Ident No.	LMT-Code
							extra lang extra long	
2	2	120	17	6	2	1	1300397	EM-HSCN 2x2/17 2BA
3	3	120	18	6	2	1,5	1300398	EM-HSCN 3x3/18 2BA
4	4	160	19	6	2	2	1300399	EM-HSCN 4x4/19 2BA
6	6	160	92	6	2	3	1300401	EM-HSCN 6x6/92 2BA
8	8	160	92	8	2	4	1300402	EM-HSCN 8x8/92 2BA
10	10	160	92	10	2	5	1300403	EM-HSCN 10x10/92 2BA
12	12	200	112	12	2	6	1300404	EM-HSCN 12x12/112 2BA
16	16	200	110	16	4	8	1300405	EM-HSCN 16x16/110 4BA

Schnittwertempfehlungen ab Seite 52
Cutting data recommendations starting page 52

■ = Hauptanwendung First choice
□ = Nebenanwendung Second choice

HScline N

Schnittwertempfehlungen für Schafffräser mit Eckenradius und runder Stirn

Cutting data recommendations for end mills corner radius or ball nose

	Werkstoff	Material	Werkstoff-Nr. Material No.	DIN Bezeichnung Alt DIN Description Old	R _m /UTS (N/mm ²)	DIN Bezeichnung Neu DIN Description New
P	Unlegierter Baustahl + Automatenstahl	Plain carbon steel + free cutting steel	1.0570	St52-3	-700	S355J2G3
			1.1730	C45	-800	C45U
			1.0715	9SMn28	-700	11SMn30
			1.1191	Ck45	500-950	C45E
	Vergütungsstahl, mittelfest	Heat-treatment steel, medium strength	1.7225	42CrMo4	500-950	42CrMo4
			1.8159	51CrV4		51CrV4
	Stahlguss	Cast steel	1.0416	GS40	-950	GS40
	Einsatzstahl	Case hardening steel	1.7131	16MnCr5	-950	16MnCr5
	Rost- und säurebe- ständiger Stahl, ferritisch, martensitisch	Stainless steel, ferritic, martensitic	1.4006	X10Cr13	500-950	X12Cr13
			1.4104	X12CrMoS17		X14CrMoS17
			1.4122	X35CrMo17		X39CrMo17-1
	Vergütungsstahl, hochfest	Heat-treatment steel, high strength	1.7225	42CrMo4	950-1400	42CrMo4
	Nitrierstahl, vergütet	Nitriding steel, heat treated	1.6580	30CrNiMo8		30CrNiMo8
			1.8504	34CrAl6	950-1400	34CrAl6
	Werkzeugstahl	Tool steel	1.2344	X40CrMoV5.1	-900	X40CrMoV5-1
			1.2343	X38CrMoV5 1	950-1400	X37CrMoV5-1
1.2316			X38CrMo16	-1100	X38CrMo16	
1.2379			X155CrVMo12 1	-950	X153CrMoV12-1	
1.2080			X210Cr12	950-1400	X210Cr12	
1.2358			60CrMoV18-5	850-1000	60CrMoV18-5	
1.2714			55NiCrMoV7	1100-1350	55NiCrMoV7	
1.2311			40CrMnMo7	-1100	40CrMnMo7	
1.2312			40CrMnNiMoS8.6	-1150	40CrMnNiMoS8-6	
1.2738			45CrMnNiMo8.6.4	950-1150	45CrMnNiMo8-6-4	
M	Rost- und säurebe- ständiger Stahl, austenitisch	Stainless steel, austenitic	1.4301	X2CrNiMo17-12-2	500-950	X5CrNiMo18-10
			1.4404	X6CrNiMoTi17-12-2		X2CrNiMo17-12-2
			1.4571	X10CrNiMoTi18	500-950	X10CrNiMoTi18
	Rost- und säurebe- ständiger Stahl, martensitisch aushärtbar	Stainless steel, martensitic steel	1.2709	X3NiCoMoTi18-9-5	800-1000	X3NiCoMoTi18-9-5
1.4542			X5CrNiCuNb16-4		X5CrNiCuNb16-4	
1.4568			X7CrNiAl17-7		X7CrNiAl17-7	
K	Grauguss	Grey cast iron	0.6025	GG25	100-400 (120-260 HB)	EN-GJ1-250
	Legierter Grauguss	Alloyed grey cast iron	0.6678	GGL-NiCr35 2	150-250 (160-230 HB)	EN-GJLA-XNiCr35-2
	Sphäroguss	Nodular cast iron	0.7070	GGG70L	400-800	EN-GJS-700-2U
			0.7060	GGG60	(120-310 HB)	EN-GJS-600-3
Temperguss	Malleable cast iron	0.8155	GTS55	350-700 (150-280 HB)	EN-GJMB-550-4	
N	Aluminium-Legierungen, kurzspanend	Aluminium alloys, short chipping	3.2581	G-AlSi12	-400	G-IGK-AlSi12
	Aluminium-Legierungen, langspanend	Aluminium alloys, long chipping	3.3535	AlMg3	-550	AlMg3
			3.4365	AlZnMgCu1,5		AlZnMgCu1,5
	Kupfer-Legierungen, kurzspanend	Copper alloys, short chipping	2.0402	MS58	-500	CuZn40Pb2
	Kupfer-Legierungen, langspanend	Copper alloys, long chipping	2.0320	MS63	300-500	CuZn37
			2.0975	CuAl10Ni		CuAl10Fe5Ni5-C
	Thermoplaste	Thermoplastics		PVC	40-70	PVC
Duroplaste	Duroplastics		Bakelit, Melamin	20-40	Bakelit, Melamin	
Graphit	Graphite					
S	Titan-Legierungen, mittelfest	Titanium alloys, medium strength	3.7115	TiAl5Sn2,5	-950	TiAl5Sn2-5
			3.7164	TiAl6V4		Ti6AlV4
	Titan-Legierungen, hochfest	Titanium alloys, high strength	3.7174	TiAl6Sn2	900-1400	TiAl6V6Sn2
	Nickelbasis-Legierungen, mittelfest	Nickel based alloys, medium strength	2.4670	NiCr12Al6MoNb	-950	NiCr12Al6MoNb
Nickelbasis-Legierungen, hochwarmfest	Heat resistant nickel based alloys, high strength	2.4668	NiCr19Fe19NbMo	900-1400	Inconel 718 NiCr19Fe19Nb5Mo3	
H	Hartguss	Chilled cast iron		Ni-hard, Ampco	300-600 HB	Ni-hard, Ampco
	Gehärteter Stahl	Hardened steel			45-52 HRC	

	Schnitt- geschwindigkeit Cutting speed v_c (m/min)	Fräserdurchmesser Cutting diameter (mm)			
		Vorschub pro Zahn Feed per tooth f_z (mm/z.)			
	Schlichten Finishing				
	1412C	Ø 1-4	Ø 5-8	Ø 10-12	Ø 14-20
	600	0,05	0,10	0,12	0,15
	600	0,05	0,10	0,12	0,15
	600	0,05	0,10	0,12	0,15
	450	0,04	0,07	0,10	0,13
	450	0,03	0,07	0,10	0,13
	400	0,015	0,04	0,08	0,12
	300	0,015	0,04	0,08	0,12
	350	0,03	0,06	0,09	0,13
	300	0,02	0,05	0,07	0,01
	250	0,03	0,06	0,90	0,12
	220				
	230	0,03	0,06	0,90	0,12
	250	0,04	0,07	0,10	0,13
	230	0,03	0,065	0,085	0,11
	180	0,04	0,07	0,10	0,13
	600	0,04	0,07	0,10	0,13
	500	0,04	0,07	0,10	0,14
	500	0,02	0,06	0,07	0,09
	350	0,02	0,06	0,07	0,09
	300	0,02	0,06	0,07	0,09
	800	0,04	0,08	0,10	0,12
	1000	0,04	0,08	0,10	0,12
	700	0,04	0,08	0,10	0,12
	1000	0,04	0,08	0,10	0,12
	600	0,05	0,10	0,12	0,15
	700	0,04	0,08	0,10	0,12
	1000	0,04	0,07	0,10	0,14
	120	0,02	0,06	0,07	0,09
	80	0,015	0,05	0,06	0,08
	100	0,02	0,06	0,07	0,09
	60	0,015	0,05	0,06	0,08
	50-70	0,025	0,045	0,055	0,075
	160-200	0,025	0,045	0,055	0,075

Die angegebenen Schnittwerte sind Startwerte und müssen auf die vorhandenen Bedingungen abgestimmt werden.

The cutting data indicated are starting values based and must be adjusted to the prevailing conditions.

Hinweise zur Ermittlung des effektiven Schneidendurchmessers bei Kugelfräsern auf Seite 99.

Hints for calculation of the effective cutting diameter of ball nose end mills on page 99.

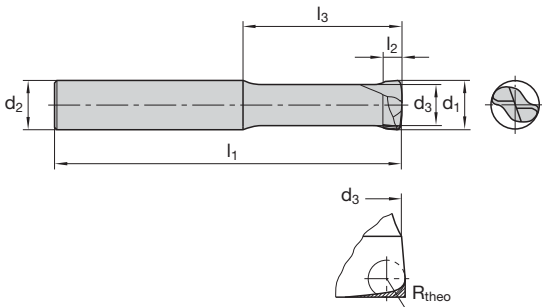

Katalog-Nr. Cat.-No.		1430C									
P		■									
M		■									
K		■									
N											
S											
H		□									
O											
d ₁	d ₃	l ₂	l ₁	l ₃	d ₂	z	R _{theo}	a _{p max}	Ident No.	LMT-Code	
extra kurz extra short											
1	0,8	0,35	40	2	3	2	0,1	0,05	1300994	EM-2F 1x0.35/2 2FA	
2	1,6	0,7	40	4	4	2	0,2	0,1	1300995	EM-2F 2x0.7/4 2FA	
3	2,5	1	50	6	6	2	0,3	0,15	1300996	EM-2F 3x1/6 2FA	
4	3,4	1,5	57	8	6	2	0,4	0,2	1301100	EM-2F 4x1.5/8 2FA	
5	4,2	2	57	10	6	2	0,5	0,25	1301101	EM-2F 5x2/10 2FA	
6	5	2,5	57	12	6	2	0,6	0,3	1301102	EM-2F 6x2.5/12 2FA	
8	6,7	3	63	16	8	2	0,8	0,4	1301103	EM-2F 8x3/16 2FA	
10	8,5	3,5	72	20	10	2	1	0,5	1301104	EM-2F 10x3.5/20 2FA	
12	10	4	83	24	12	2	1,2	0,6	1301105	EM-2F 12x4/24 2FA	
kurz short											
1	0,8	0,35	40	4	3	2	0,1	0,05	1300997	EM-2F 1x0.35/4 2FA	
2	1,6	0,7	40	8	4	2	0,2	0,1	1300998	EM-2F 2x0.7/8 2FA	
3	2,5	1	57	12	6	2	0,3	0,15	1300999	EM-2F 3x1/12 2FA	
4	3,4	1,5	57	15	6	2	0,4	0,2	1110170	EM-2F 4x1.5/15 2FA	
5	4,2	2	57	17,5	6	2	0,5	0,25	1110171	EM-2F 5x2/17.5 2FA	
6	5	2,5	57	19	6	2	0,6	0,3	1110172	EM-2F 6x2.5/19 2FA	
8	6,7	3	63	24	8	2	0,8	0,4	1110173	EM-2F 8x3/24 2FA	
10	8,5	3,5	72	28,5	10	2	1	0,5	1110174	EM-2F 10x3.5/28.5 2FA	
12	10	4	83	34	12	2	1,2	0,6	1110175	EM-2F 12x4/34 2FA	
16	13,5	5,5	92	39	16	2	1,6	0,8	1110176	EM-2F 16x5.5/39 2FA	
20	17	7	104	48	20	2	2	1	1110177	EM-2F 20x7/48 2FA	
lang long											
4	3,4	1,5	70	24	6	2	0,4	0,2	1300988	EM-2F 4x1.5/24 2FA	
5	4,2	2	70	30	6	2	0,5	0,25	1300989	EM-2F 5x2/30 2FA	
6	5	2,5	80	35	6	2	0,6	0,3	1300990	EM-2F 6x2.5/35 2FA	
8	6,7	3	80	40	8	2	0,8	0,4	1300991	EM-2F 8x3/40 2FA	
10	8,5	3,5	90	45	10	2	1	0,5	1300992	EM-2F 10x3.5/45 2FA	
12	10	4	100	50	12	2	1,2	0,6	1300993	EM-2F 12x4/50 2FA	

Schnittwertempfehlungen ab Seite 56
 Cutting data recommendations starting page 56

■ = Hauptanwendung First choice
 □ = Nebenanwendung Second choice



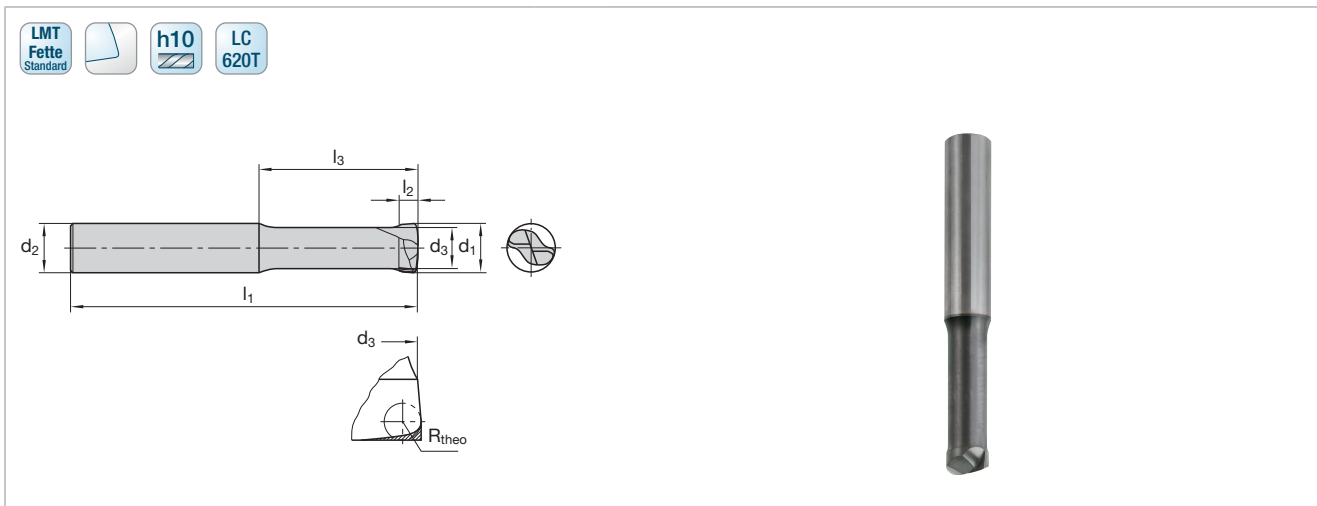

Katalog-Nr. Cat.-No.										1430C	
P										■	
M										■	
K										■	
N											
S											
H										□	
O											
d ₁	d ₃	l ₂	l ₁	l ₃	d ₂	z	R _{theo}	a _{p max}	Ident No.	LMT-Code	
extra lang extra long											
4	3,4	1,5	80	34	6	2	0,4	0,2	1110180	EM-2F 4x1.5/34 2FA	
5	4,2	2	80	37	6	2	0,5	0,25	1110181	EM-2F 5x2/37 2FA	
6	5	2,5	80	42	6	2	0,6	0,3	1110182	EM-2F 6x2.5/42 2FA	
8	6,7	3	90	51	8	2	0,8	0,4	1110183	EM-2F 8x3/51 2FA	
10	8,5	3,5	100	56,5	10	2	1	0,5	1110184	EM-2F 10x3.5/56.5 2FA	
12	10	4	110	61	12	2	1,2	0,6	1110185	EM-2F 12x4/61 2FA	
16	13,5	5,5	130	77	16	2	1,6	0,8	1110186	EM-2F 16x5.5/77 2FA	

Schnittwertempfehlungen ab Seite 56
Cutting data recommendations starting page 56

■ = Hauptanwendung First choice
□ = Nebenanwendung Second choice

MultiEdge 2Feed HSC
Schnittwertempfehlungen
Cutting data recommendations

	Werkstoff	Material	Werkstoff-Nr. Material No.	DIN Bezeichnung Alt DIN Description Old	R_m/UTS (N/mm²)	DIN Bezeichnung Neu DIN Description New
P	Unlegierter Baustahl + Automatenstahl	Plain carbon steel + free cutting steel	1.0570	St52-3	-700	S355J2G3
			1.1730	C45	-800	C45U
			1.0715	9SMn28	-700	11SMn30
			1.1191	Ck45	500-950	C45E
			1.7219	26CrMo4		26CrMo4-2
	Vergütungsstahl, mittelfest	Heat-treatment steel, medium strength	1.7225	42CrMo4	500-950	42CrMo4
			1.8159	51CrV4		51CrV4
	Stahlguss	Cast steel	1.0416	GS40	-950	GS40
	Einsatzstahl	Case hardening steel	1.7131	16MnCr5	-950	16MnCr5
	Rost- und säurebe- ständiger Stahl, ferritisch, martensitisch	Stainless steel, ferritic, martensitic	1.4006	X10Cr13	500-950	X12Cr13
			1.4104	X12CrMoS17		X14CrMoS17
			1.4122	X35CrMo17		X39CrMo17-1
	Vergütungsstahl, hochfest	Heat-treatment steel, high strength	1.7225	42CrMo4	950-1400	42CrMo4
			1.6580	30CrNiMo8		30CrNiMo8
	Nitrierstahl, vergütet	Nitriding steel, heat treated	1.8504	34CrAl6	950-1400	34CrAl6
			1.2344	X40CrMoV5.1	-900	X40CrMoV5-1
	Werkzeugstahl	Tool steel	1.2343	X38CrMoV5 1	950-1400	X37CrMoV5-1
1.2316			X38CrMo16	-1100	X38CrMo16	
1.2379			X155CrVMo12 1	-950	X153CrMoV12-1	
1.2080			X210Cr12	950-1400	X210Cr12	
1.2358			60CrMoV18-5	850-1000	60CrMoV18-5	
1.2714			55NiCrMoV7	1100-1350	55NiCrMoV7	
1.2311			40CrMnMo7	-1100	40CrMnMo7	
1.2312			40CrMnNiMoS8.6	-1150	40CrMnNiMoS8-6	
1.2738	45CrMnNiMo8.6.4	950-1150	45CrMnNiMo8-6-4			
M	Rost- und säurebe- ständiger Stahl, austenitisch	Stainless steel, austenitic	1.4301	X2CrNiMo17-12-2	500-950	X5CrNiMo18-10
			1.4404	X6CrNiMoTi17-12-2		X2CrNiMo17-12-2
			1.4571	X10CrNiMoTi18		X10CrNiMoTi18
Rost- und säurebe- ständiger Stahl, martensitisch aushärtbar	Stainless steel, martensitic steel	1.2709	X3NiCoMoTi18-9-5	800-1000	X3NiCoMoTi18-9-5	
		1.4542	X5CrNiCuNb16-4		X5CrNiCuNb16-4	
		1.4568	X7CrNiAl17-7		X7CrNiAl17-7	
K	Grauguss	Grey cast iron	0.6025	GG25	100-400 (120-260 HB)	EN-GJI-250
	Legierter Grauguss	Alloyed grey cast iron	0.6678	GGL-NiCr35 2	150-250 (160-230 HB)	EN-GJLA-XNiCr35-2
	Sphäroguss	Nodular cast iron	0.7070	GGG70L	400-800	EN-GJS-700-2U
			0.7060	GGG60	(120-310 HB)	EN-GJS-600-3
	Temperguss	Malleable cast iron	0.8155	GTS55	350-700 (150-280 HB)	EN-GJMB-550-4
H	Hartguss	Chilled cast iron		Ni-hard, Ampco	300-600 HB	Ni-hard, Ampco
	Gehärteter Stahl	Hardened steel			45-52 HRC	

Die angegebenen Schnittwerte sind Startwerte bezogen auf Ø 10 mm und müssen auf die vorhandenen Bedingungen abgestimmt werden.

Bei der langen Ausführung empfehlen wir die f_z-Werte um 30% zu reduzieren.

The cutting data indicated are starting values based on Ø 10 mm and must be adjusted to the prevailing conditions.

We recommended to reduce the f_z-value with the long version by 30%.

	Schnittgeschwindigkeit Cutting speed v_c (m/min)	Fräserdurchmesser Cutting diameter (mm)			Schnitttiefe Cutting depth a_p (mm)
		Vorschub pro Zahn Feed per tooth f_z (mm/z.)			
		Ø 1-4	Ø 5-10	Ø 12-20	
	300	0,30	0,70	1,00	0,05 x d_1
	300	0,30	0,70	1,00	
	300	0,30	0,70	1,00	
	240	0,25	0,60	0,80	
	200	0,25	0,60	0,80	
	240	0,25	0,60	0,80	
	200	0,25	0,60	0,80	
	200	0,25	0,60	0,80	
	180	0,25	0,60	0,80	0,04 x d_1
	220	0,25	0,60	0,80	0,04 x d_1
	200	0,20	0,50	0,70	
	200	0,25	0,60	0,80	
	230	0,20	0,50	0,70	0,02 x d_1
	230	0,20	0,50	0,70	
	250	0,50	0,90	1,30	0,04 x d_1
	250	0,45	0,80	1,20	
	180	0,20	0,50	0,70	
	180	0,30	0,70	1,00	
	150	0,30	0,70	1,00	
	100	0,20	0,50	0,70	0,03 x d_1
	160-180	0,15	0,30	0,50	

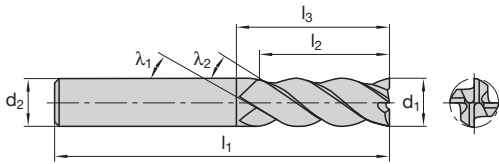

Katalog-Nr. Cat.-No.						1521C		1522C	
P						■		■	
M									
K						■		■	
N									
S									
H									
O									
d ₁	l ₂	l ₁	l ₃	d ₂	z	Ident No.	LMT-Code	Ident No.	LMT-Code
kurz short									
3	4	40	6	4	4	9186423	EM-DHC 3x4/6 4EA	-	-
4	5	54	8	6	4	1190000	EM-DHC 4x5/8 4EA	1190010	EM-DHC 4x5/8 4EB
5	6	54	10	6	4	1190001	EM-DHC 5x6/10 4EA	1190011	EM-DHC 5x6/10 4EB
6	7	54	16	6	4	1190002	EM-DHC 6x7/16 4EA	1190012	EM-DHC 6x7/16 4EB
8	9	58	20	8	4	1190003	EM-DHC 8x9/20 4EA	1190013	EM-DHC 8x9/20 4EB
10	11	66	24	10	4	1190004	EM-DHC 10x11/24 4EA	1190014	EM-DHC 10x11/24 4EB
12	12	73	26	12	4	1190005	EM-DHC 12x12/26 4EA	1190015	EM-DHC 12x12/26 4EB
16	16	82	32	16	4	1190007	EM-DHC 16x16/32 4EA	1190017	EM-DHC 16x16/32 4EB
20	20	92	40	20	4	1190009	EM-DHC 20x20/40 4EA	1190019	EM-DHC 20x20/40 4EB

■ = Hauptanwendung First choice
 □ = Nebenanwendung Second choice

Schnittwertempfehlungen ab Seite 62
 Cutting data recommendations starting page 62

Kantenschutzfase Edge protection chamfer	d ₁	b
	1	0,025
	2	0,05
	3	0,075
	4	0,1
	5	0,15
	6-12	0,2
	14-20	0,3



DHC
Schafffräser mit ungleichem Drallwinkel
End mills with uneven helix angle

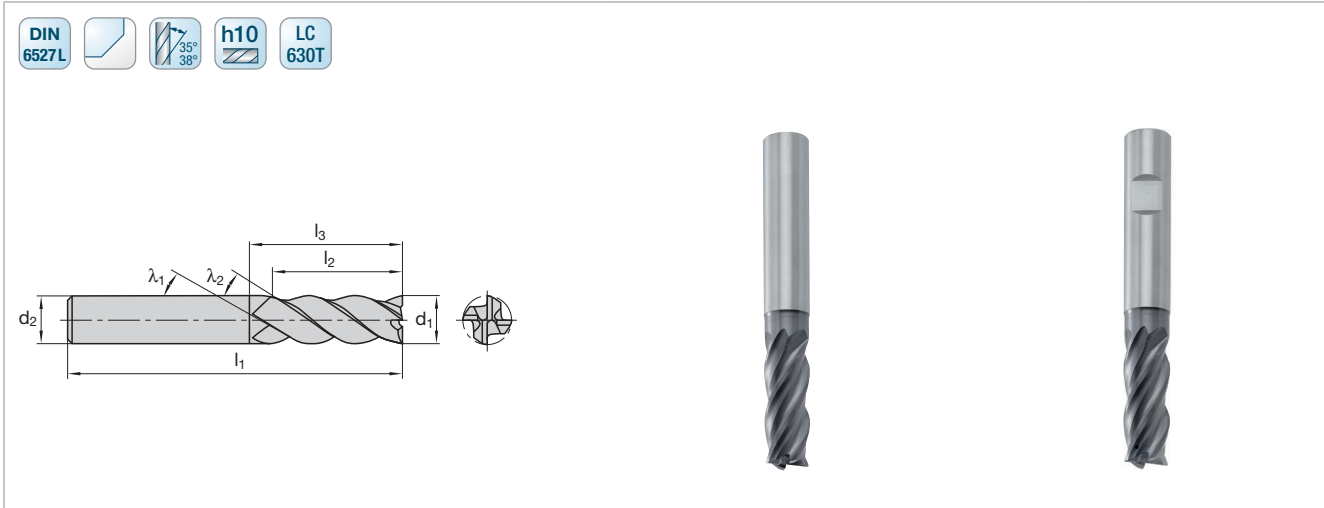

Katalog-Nr. Cat.-No.						1521C		1522C	
P						■		■	
M									
K						■		■	
N									
S									
H									
O									
d ₁	l ₂	l ₁	l ₃	d ₂	z	Ident No.	LMT-Code	Ident No.	LMT-Code
lang long									
2	4	40	6	4	4	9186425	EM-DHC 2x4/6 4EA	-	-
3	6	40	9	4	4	9186426	EM-DHC 3x6/9 4EA	-	-
4	8	54	12	6	4	1110700	EM-DHC 4x8/12 4EA	1110705	EM-DHC 4x8/12 4EB
5	10	54	15	6	4	1110701	EM-DHC 5x10/15 4EA	1110706	EM-DHC 5x10/15 4EB
6	13	57	21	6	4	1110223	EM-DHC 6x13/21 4EA	1110231	EM-DHC 6x13/21 4EB
8	19	63	27	8	4	1110224	EM-DHC 8x19/27 4EA	1110232	EM-DHC 8x19/27 4EB
10	22	72	32	10	4	1110225	EM-DHC 10x22/32 4EA	1110233	EM-DHC 10x22/32 4EB
12	26	83	38	12	4	1110226	EM-DHC 12x26/38 4EA	1110234	EM-DHC 12x26/38 4EB
14	26	83	38	14	4	1110227	EM-DHC 14x26/38 4EA	1110235	EM-DHC 14x26/38 4EB
16	32	92	44	16	4	1110228	EM-DHC 16x32/44 4EA	1110236	EM-DHC 16x32/44 4EB
18	32	92	44	18	4	1110229	EM-DHC 18x34/44 4EA	1110237	EM-DHC 18x34/44 4EB
20	38	104	54	20	4	1110230	EM-DHC 20x38/54 4EA	1110238	EM-DHC 20x38/54 4EB

■ = Hauptanwendung First choice
 □ = Nebenanwendung Second choice

Schnittwertempfehlungen ab Seite 62
 Cutting data recommendations starting page 62

Kantenschutzfase Edge protection chamfer	d ₁	b
	1	0,025
	2	0,05
	3	0,075
	4	0,1
	5	0,15
	6-12	0,2
	14-20	0,3

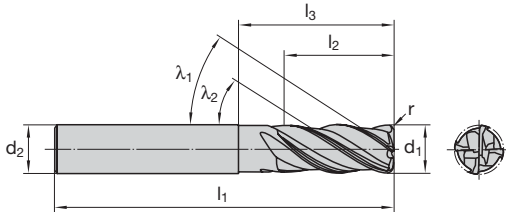

Katalog-Nr. Cat.-No.							1520C		
P							■		
M									
K							■		
N									
S									
H									
O									
d ₁	l ₂	l ₁	l ₃	d ₂	z	r (±0,01)	Ident No.	LMT-Code	
lang long									
6	13	57	21	6	4	0,5	9195608	EM-DHC 6x13/21 4R0.5B	
6	13	57	21	6	4	1	9195609	EM-DHC 6x13/21 4R1B	
8	19	63	27	8	4	2	9195614	EM-DHC 8x19/27 4R2B	
8	19	63	27	8	4	0,5	9195611	EM-DHC 8x19/27 4R0.5B	
8	19	63	27	8	4	1	9195612	EM-DHC 8x19/27 4R1B	
10	22	72	32	10	4	2	9195618	EM-DHC 10x22/32 4R2B	
10	22	72	32	10	4	0,5	9195615	EM-DHC 10x22/32 4R0.5B	
10	22	72	32	10	4	1	9195616	EM-DHC 10x22/32 4R1B	
12	26	83	38	12	4	0,5	9195619	EM-DHC 12x26/38 4R0.5B	
12	26	83	38	12	4	1	9195620	EM-DHC 12x26/38 4R1B	
12	26	83	38	12	4	1,5	9195621	EM-DHC 12x26/38 4R1.5B	
12	26	83	38	12	4	2	9195622	EM-DHC 12x26/38 4R2B	

Schnittwertempfehlungen ab Seite 62
 Cutting data recommendations starting page 62

■ = Hauptanwendung First choice
 □ = Nebenanwendung Second choice



DHC
Schnittwertempfehlungen für Schafffräser
Cutting data recommendations for end mills

	Werkstoff	Material	Werkstoff-Nr. Material No.	DIN Bezeichnung Alt DIN Description Old	R_m/UTS (N/mm²)	DIN Bezeichnung Neu DIN Description New
P	Unlegierter Baustahl + Automatenstahl	Plain carbon steel + free cutting steel	1.0570	St52-3	-700	S355J2G3
			1.1730	C45	-800	C45U
			1.0715	9SMn28	-700	11SMn30
			1.1191	Ck45	500-950	C45E
			1.7219	26CrMo4		26CrMo4-2
	Vergütungsstahl, mittelfest	Heat-treatment steel, medium strength	1.7225	42CrMo4	500-950	42CrMo4
			1.8159	51CrV4		51CrV4
	Stahlguss	Cast steel	1.0416	GS40	-950	GS40
	Einsatzstahl	Case hardening steel	1.7131	16MnCr5	-950	16MnCr5
	Rost- und säurebe- ständiger Stahl, ferritisch, martensitisch	Stainless steel, ferritic, martensitic	1.4006	X10Cr13	500-950	X12Cr13
			1.4104	X12CrMoS17		X14CrMoS17
			1.4122	X35CrMo17		X39CrMo17-1
	Vergütungsstahl, hochfest	Heat-treatment steel, high strength	1.7225	42CrMo4	950-1400	42CrMo4
			1.6580	30CrNiMo8		30CrNiMo8
	Nitrierstahl, vergütet	Nitriding steel, heat treated	1.8504	34CrAl6	950-1400	34CrAl6
			1.2344	X40CrMoV5.1	-900	X40CrMoV5-1
	Werkzeugstahl	Tool steel	1.2343	X38CrMoV5 1	950-1400	X37CrMoV5-1
1.2316			X38CrMo16	-1100	X38CrMo16	
1.2379			X155CrVMo12 1	-950	X153CrMoV12-1	
1.2358			60CrMoV18-5	850-1000	60CrMoV18-5	
1.2080			X210Cr12	950-1400	X210Cr12	
1.2714			55NiCrMoV7	1100-1350	55NiCrMoV7	
1.2311			40CrMnMo7	-1100	40CrMnMo7	
1.2312			40CrMnNiMoS8.6	-1150	40CrMnNiMoS8-6	
1.2738			45CrMnNiMo8.6.4	950-1150	45CrMnNiMo8-6-4	
K	Grauguss	Grey cast iron	0.6025	GG25	100-400 (120-260 HB)	EN-GJL-250
	Legierter Grauguss	Alloyed grey cast iron	0.6678	GGL-NiCr35 2	150-250 (160-230 HB)	EN-GJLA-XNiCr35-2
	Sphäroguss	Nodular cast iron	0.7060	GGG60	400-800	EN-GJS-600-3
			0.7070	GGG70L	(120-310 HB)	EN-GJS-700-2U
Temperguss	Malleable cast iron	0.8155	GTS55	350-700 (150-280 HB)	EN-GJMB-550-4	

1) In langer Ausführung und $a_e = d_1$ sollte a_p $0,5 \times d_1$ nicht überschreiten
 In kurzer Ausführung und $a_e = d_1$ ist a_p $1 \times d_1$ realisierbar
 In the long version and $a_e = d_1$ provided a_p should not exceed $0.5 \times d_1$
 In the short version and $a_e = d_1$ provided a_p can be equal to $1 \times d_1$

Vorschub-Korrektur-Faktoren f_1
Feed correction factor f_1

$v_f = n \cdot z \cdot f_z \cdot f_1$					
a_e	a_p	DHC lang long		DHC kurz short	
		f_1	f_1	f_1	f_1
$0,1 \cdot d_1$	$1 \times d_1$	2,2	2,4	-	-
	$1,5 \times d_1$	2	-	-	-
	$2 \times d_1^{1)}$	1,6	-	-	-
$0,25 \cdot d_1$	$1 \times d_1$	1,6	2	-	-
	$1,5 \times d_1$	1,4	-	-	-
	$2 \times d_1^{1)}$	1,2	-	-	-
$0,5 \cdot d_1$	$1 \times d_1$	1,1	1,5	-	-
	$1,5 \times d_1$	1	-	-	-
	$2 \times d_1^{1)}$	0,8	-	-	-
$0,75 \cdot d_1$	$1 \times d_1$	0,8	1	-	-
	$1,5 \times d_1$	0,7	-	-	-
$1 \cdot d_1^{2)}$	$0,5 \times d_1$	0,6	0,7	-	-
	$1 \times d_1$	0,5	-	-	-
	$2 \times d_1$	0,4	-	-	-

1) $1,8 \times d_1$ für Durchmesser 14, 18, 20
 $1.8 \times d_1$ for diameter 14, 18, 20

2) Beim Nutenfräsen Schnittgeschwindigkeit v_c
 um 15 % reduzieren
 When slot milling reduce the cutting speed v_c
 by 15 %

a_e = Schnittbreite in mm
 Width of cut in mm
 a_p = Schnitttiefe in mm
 Depth of cut in mm
 d_1 = Durchmesser in mm
 Cutter diameter in mm
 f_1 = Korrekturfaktor für v_f
 Correction factor for v_f
 f_z = Vorschub pro Zahn in mm
 Feed per tooth in mm
 n = Drehzahl in min^{-1}
 Speed in min^{-1}
 v_f = Vorschubgeschwindigkeit in mm/min
 Feed rate in mm/min
 z = Anzahl der Schneiden
 No. of teeth

Schnitt- geschwindigkeit Cutting speed v_c (m/min)	Kühlung Coolant	Fräserdurchmesser Cutting diameter (mm)										
		Vorschub pro Zahn Feed per tooth f_z (mm/z.)										
		1 ¹⁾	2 ¹⁾	3 ¹⁾	4	5	6	8	10	12	14–16	18–20
230		0,008	0,016	0,025	0,04	0,06	0,07	0,09	0,11	0,13	0,18	0,22
230		0,008	0,016	0,025	0,04	0,06	0,07	0,09	0,11	0,13	0,18	0,22
200		0,007	0,014	0,02	0,04	0,05	0,06	0,08	0,10	0,12	0,16	0,20
160		0,007	0,014	0,02	0,04	0,05	0,06	0,08	0,10	0,12	0,16	0,20
130		0,007	0,014	0,02	0,03	0,04	0,05	0,07	0,09	0,10	0,14	0,17
160		0,007	0,014	0,02	0,04	0,05	0,06	0,08	0,10	0,12	0,16	0,20
140		0,007	0,014	0,02	0,04	0,05	0,06	0,08	0,10	0,12	0,16	0,20
120		0,005	0,01	0,015	0,03	0,04	0,05	0,06	0,08	0,09	0,12	0,15
110		0,005	0,01	0,015	0,03	0,04	0,05	0,06	0,08	0,09	0,12	0,15
100		0,005	0,01	0,015	0,03	0,04	0,04	0,06	0,07	0,08	0,11	0,14
180			0,01	0,03	0,04	0,06	0,07	0,08	0,11	0,14	0,17	0,22
160		0,01	0,02	0,03	0,05	0,06	0,07	0,10	0,12	0,14	0,19	0,24
150		0,009	0,018	0,025	0,04	0,06	0,07	0,09	0,11	0,13	0,18	0,22
120		0,009	0,018	0,025	0,04	0,06	0,07	0,09	0,11	0,13	0,18	0,22

Die angegebenen Schnittwerte sind Startwerte und müssen auf die vorhandenen Bedingungen abgestimmt werden.
 The cutting data indicated are starting values and must be adjusted to the prevailing conditions.

Trockenbearbeitung, Pressluftkühlung ist vorteilhaft
 Dry machining, air-blast cooling is advantageous

Nassbearbeitung, auf ausreichende Emulsionszuführung achten
 Wet machining, sufficient emulsion volume required

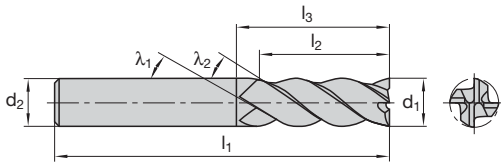

Katalog-Nr. Cat.-No.						1820C		1821C	
P						■		■	
M									
K						■		■	
N									
S									
H									
O									
d ₁	l ₂	l ₁	l ₃	d ₂	z	Ident No.	LMT-Code	Ident No.	LMT-Code
kurz short									
1	1,5	40	2	4	4	7083436	EM-DHCP 1x1.5/2 4EA	-	-
2	3	40	4	4	4	7083437	EM-DHCP 2x3/4 4EA	-	-
3	4	40	6	4	4	7083438	EM-DHCP 3x4/6 4EA	-	-
4	5	54	8	6	4	7106927	EM-DHCP 4x5/8 4EA	7083439	EM-DHCP 4x5/8 4EB
5	6	54	10	6	4	7106928	EM-DHCP 5x6/10 4EA	7083440	EM-DHCP 5x6/10 4EB
6	7	54	16	6	4	7106929	EM-DHCP 6x7/16 4EA	7083441	EM-DHCP 6x7/16 4EB
8	9	58	20	8	4	7106930	EM-DHCP 8x9/20 4EA	7083442	EM-DHCP 8x9/20 4EB
10	11	66	24	10	4	7106931	EM-DHCP 10x11/24 4EA	7083443	EM-DHCP 10x11/24 4EB
12	12	73	26	12	4	7106932	EM-DHCP 12x12/26 4EA	7083444	EM-DHCP 12x12/26 4EB
14	14	75	28	14	4	7106933	EM-DHCP 14x14/28 4EA	7083445	EM-DHCP 14x14/28 4EB
16	16	82	32	16	4	7106934	EM-DHCP 16x16/32 4EA	7083446	EM-DHCP 16x16/32 4EB
18	18	84	34	18	4	7106935	EM-DHCP 18x18/34 4EA	7083447	EM-DHCP 18x18/34 4EB
20	20	92	40	20	4	7106936	EM-DHCP 20x20/40 4EA	7083448	EM-DHCP 20x20/40 4EB

■ = Hauptanwendung First choice
 □ = Nebenanwendung Second choice

Schnittwertempfehlungen ab Seite 66
 Cutting data recommendations starting page 66

Kantenschutzfase Edge protection chamfer	d ₁	b
	1	0,025
	2	0,05
	3	0,075
	4	0,1
	5	0,15
	6-12	0,2
	14-20	0,3





Katalog-Nr. Cat.-No.						1820C		1821C	
P						■		■	
M									
K						■		■	
N									
S									
H									
O									
d ₁	l ₂	l ₁	l ₃	d ₂	z	Ident No.	LMT-Code	Ident No.	LMT-Code
lang long									
1	2,5	40	3	4	4	7083449	EM-DHCP 1x2.5/3 4EA	-	-
2	4	40	6	4	4	7083450	EM-DHCP 2x4/6 4EA	-	-
3	6	40	9	4	4	7083451	EM-DHCP 3x6/9 4EA	-	-
4	8	54	12	6	4	7106937	EM-DHCP 4x8/12 4EA	7083452	EM-DHCP 4x8/12 4EB
5	10	54	15	6	4	7106938	EM-DHCP 5x10/15 4EA	7083453	EM-DHCP 5x10/15 4EB
6	13	57	21	6	4	7106939	EM-DHCP 6x13/21 4EA	7083454	EM-DHCP 6x13/21 4EB
8	19	63	27	8	4	7106940	EM-DHCP 8x19/27 4EA	7083455	EM-DHCP 8x19/27 4EB
10	22	72	32	10	4	7106941	EM-DHCP 10x22/32 4EA	7083456	EM-DHCP 10x22/32 4EB
12	26	83	38	12	4	7106942	EM-DHCP 12x26/38 4EA	7083457	EM-DHCP 12x26/38 4EB
14	26	83	38	14	4	7106943	EM-DHCP 14x26/38 4EA	7083458	EM-DHCP 14x26/38 4EB
16	32	92	44	16	4	7106944	EM-DHCP 16x32/44 4EA	7083459	EM-DHCP 16x32/44 4EB
18	32	92	44	18	4	7106945	EM-DHCP 18x32/44 4EA	7083460	EM-DHCP 18x32/44 4EB
20	38	104	54	20	4	7106946	EM-DHCP 20x38/54 4EA	7083461	EM-DHCP 20x38/54 4EB
extra lang extra long									
6	9	65	29	6	4	7106947	EM-DHCP 6x9/29 4EA	7083462	EM-DHCP 6x9/29 4EB
8	12	75	39	8	4	7106948	EM-DHCP 8x12/39 4EA	7083463	EM-DHCP 8x12/39 4EB
10	15	80	40	10	4	7106949	EM-DHCP 10x15/40 4EA	7083464	EM-DHCP 10x15/40 4EB
12	18	93	48	12	4	7106950	EM-DHCP 12x18/48 4EA	7083465	EM-DHCP 12x18/48 4EB
16	24	108	60	16	4	7106951	EM-DHCP 16x24/60 4EA	7083466	EM-DHCP 16x24/60 4EB
20	30	126	76	20	4	7106952	EM-DHCP 20x30/76 4EA	7083467	EM-DHCP 20x30/76 4EB

■ = Hauptanwendung First choice
 □ = Nebenanwendung Second choice

Schnittwertempfehlungen ab Seite 66
 Cutting data recommendations starting page 66

Kantenschutzfase Edge protection chamfer	d ₁	b
	1	0,025
	2	0,05
	3	0,075
	4	0,1
	5	0,15
	6-12	0,2
	14-20	0,3

DHC Premium
Schnittwertempfehlungen für Schafffräser
Cutting data recommendations for end mills

	Werkstoff	Material	Werkstoff-Nr. Material No.	DIN Bezeichnung Alt DIN Description Old	R_m/UTS (N/mm²)	DIN Bezeichnung Neu DIN Description New
P	Unlegierter Baustahl + Automatenstahl	Plain carbon steel + free cutting steel	1.0570	St52-3	-700	S355J2G3
			1.1730	C45	-800	C45U
			1.0715	9SMn28	-700	11SMn30
			1.1191	Ck45	500-950	C45E
			1.7219	26CrMo4		26CrMo4-2
	Vergütungsstahl, mittelfest	Heat-treatment steel, medium strength	1.7225	42CrMo4	500-950	42CrMo4
			1.8159	51CrV4		51CrV4
	Stahlguss	Cast steel	1.0416	GS40	-950	GS40
	Einsatzstahl	Case hardening steel	1.7131	16MnCr5	-950	16MnCr5
	Rost- und säurebe- ständiger Stahl, ferritisch, martensitisch	Stainless steel, ferritic, martensitic	1.4006	X10Cr13	500-950	X12Cr13
			1.4104	X12CrMoS17		X14CrMoS17
			1.4122	X35CrMo17		X39CrMo17-1
	Vergütungsstahl, hochfest	Heat-treatment steel, high strength	1.7225	42CrMo4	950-1400	42CrMo4
	1.6580	30CrNiMo8	30CrNiMo8			
	Nitrierstahl, vergütet	Nitriding steel, heat treated	1.8504	34CrAl6	950-1400	34CrAl6
			1.2344	X40CrMoV5.1		X40CrMoV5-1
	Werkzeugstahl	Tool steel	1.2379	X155CrVMo12 1	240-350 HB	X153CrMoV12-1
			1.2080	X210Cr12		X210Cr12
1.2343			X38CrMoV5 1	950-1400	X37CrMoV5-1	
1.2358			60CrMoV18-5		850-1000	60CrMoV18-5
1.2714			55NiCrMoV7	1100-1350	55NiCrMoV7	
1.2311			40CrMnMo7		-1100	40CrMnMo7
1.2312			40CrMnNiMoS8.6	-1150	40CrMnNiMoS8-6	
1.2316			X38CrMo16	-1100	X38CrMo16	
1.2738			45CrMnNiMo8.6.4	950-1150	45CrMnNiMo8-6-4	
K	Grauguss	Grey cast iron	0.6025	GG25	100-400 (120-260 HB)	EN-GJL-250
	Legierter Grauguss	Alloyed grey cast iron	0.6678	GGL-NiCr35 2	150-250 (160-230 HB)	EN-GJLA-XNiCr35-2
	Sphäroguss	Nodular cast iron	0.7060	GGG60	400-800 (120-310 HB)	EN-GJS-600-3
			0.7070	GGG70L		EN-GJS-700-2U
Temperguss	Malleable cast iron	0.8155	GTS55	350-700 (150-280 HB)	EN-GJMB-550-4	

Die angegebenen Schnittwerte sind Startwerte und müssen auf die vorhandenen Bedingungen abgestimmt werden.
 The cutting data indicated are starting values and must be adjusted to the prevailing conditions.

Vorschub-Korrektur-Faktoren f₁
Feed correction factor f₁

v_f = n · z · f_z · f₁				
a_e	a_p	DHC Premium kurz short f₁	DHC Premium lang long f₁	DHC Premium extra lang extra long³⁾ f₁
0,1 · d ₁	1 x d ₁	2,4	2,2	1,6
	1,5 x d ₁	-	2	1,5
	2 x d ₁ ²⁾	-	1,6	-
0,25 · d ₁	1 x d ₁	2,1	1,6	1,1
	1,5 x d ₁	-	1,4	1
	2 x d ₁ ²⁾	-	1,2	-
0,5 · d ₁	1 x d ₁	1,6	1,2	0,7
	1,5 x d ₁	-	1	0,6
	2 x d ₁ ²⁾	-	0,8	-
0,75 · d ₁	1 x d ₁	1,1	0,8	0,5
	1,5 x d ₁	-	0,7	0,4
	2 x d ₁ ²⁾	-	0,6	-
1 · d ₁ ¹⁾	0,5 x d ₁	0,8	0,6	0,5
	1 x d ₁	-	0,5	0,4
	2 x d ₁ ²⁾	-	0,4	-

- a_e = Schnittbreite in mm
Width of cut in mm
- a_p = Schnitttiefe in mm
Depth of cut in mm
- d₁ = Durchmesser in mm
Cutter diameter in mm
- f₁ = Korrekturfaktor für v_f
Correction factor for v_f
- f_z = Vorschub pro Zahn in mm
Feed per tooth in mm
- n = Drehzahl in min⁻¹
Speed in min⁻¹
- v_f = Vorschubgeschwindigkeit in mm/min
Feed rate in mm/min
- z = Anzahl der Schneiden
No. of teeth

¹⁾ Für Durchmesser 1 bis 3: In langer Ausführung und a_e = d₁ sollte a_p 0,5 x d₁ nicht überschreiten
 For diameter 1 to 3: long version and a_e = d₁ should not cross over a_p 0,5 x d₁

²⁾ 1,8 x d₁ für Durchmesser 14, 18, 20
 1.8 x d₁ for diameter 14, 18, 20

³⁾ Für extra lange Werkzeuge v_c ggf. um 20 % reduzieren
 Reduce extra long tools cutting speed by 20 % if necessary

Schnittgeschwindigkeit Cutting speed v_c (m/min)	Kühlung Coolant	Fräserdurchmesser Cutting diameter (mm)										
		Vorschub pro Zahn Feed per tooth f_z (mm/z.)										
		1 ¹⁾	2 ¹⁾	3 ¹⁾	4	5	6	8	10	12	14–16	18–20
230–275		0,008	0,016	0,025	0,05	0,06	0,07	0,10	0,12	0,14	0,19	0,24
230–275		0,008	0,016	0,025	0,05	0,06	0,07	0,10	0,12	0,14	0,19	0,24
200–240		0,008	0,014	0,02	0,04	0,06	0,07	0,09	0,11	0,13	0,18	0,22
200–240		0,008	0,014	0,02	0,04	0,06	0,07	0,09	0,11	0,13	0,18	0,22
160–200		0,008	0,014	0,02	0,04	0,06	0,07	0,09	0,11	0,13	0,18	0,22
120–150		0,008	0,014	0,02	0,04	0,05	0,06	0,08	0,10	0,11	0,15	0,19
140–180		0,008	0,014	0,02	0,04	0,05	0,06	0,08	0,10	0,11	0,15	0,19
140–180		0,008	0,014	0,02	0,04	0,05	0,06	0,08	0,10	0,11	0,15	0,19
110–140		0,005	0,013	0,02	0,03	0,04	0,05	0,07	0,09	0,10	0,14	0,17
100–120		0,005	0,013	0,02	0,03	0,04	0,05	0,07	0,09	0,10	0,14	0,17
100–120		0,005	0,013	0,02	0,03	0,04	0,05	0,06	0,08	0,10	0,13	0,16
180–220		0,012	0,025	0,04	0,06	0,08	0,09	0,12	0,15	0,18	0,22	0,28
160–180		0,011	0,021	0,03	0,06	0,07	0,08	0,11	0,13	0,16	0,20	0,26
150–180		0,01	0,02	0,03	0,05	0,06	0,07	0,10	0,12	0,14	0,19	0,24
120–150		0,01	0,018	0,025	0,05	0,06	0,07	0,10	0,12	0,14	0,19	0,24

Trockenbearbeitung, Pressluftkühlung ist vorteilhaft
 Dry machining, air-blast cooling is advantageous

Nassbearbeitung, auf ausreichende Emulsionszuführung achten
 Wet machining, sufficient emulsion volume required

Merkmale des DHC Premium Features of the DHC Premium

Stabile Schneidkante mit Mikro-schneidkantenpräparation für gesteigerte Prozesssicherheit
 Stable cutting edge with micro cutting edge preparation for increased process reliability



Stirnlückenausführung in Radiusform für verbesserte Spanabfuhr
 Front cutting edge cavity design in radius form for improved chip removal

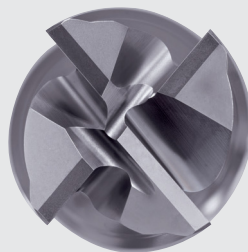

Kontinuierlich veränderte Schneidenteilung für schwingungsarmes Fräsen bei hohen Vorschüben
 Continuously variable cutting edge pitch for low-vibration milling with high feeds

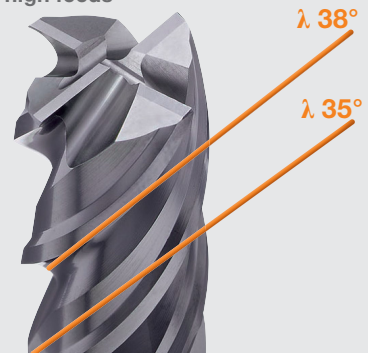

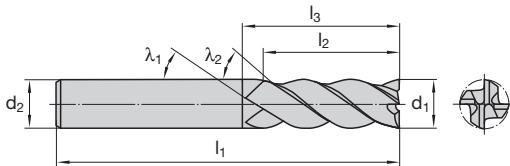

Katalog-Nr. Cat.-No.		1525C				1565C			
P									
M		■				■			
K									
N		□				□			
S		■				■			
H									
O									
d ₁	l ₂	l ₁	l ₃	d ₂	z	Ident No.	LMT-Code	Ident No.	LMT-Code
kurz short									
4	5	54	8	6	4	9097019	EM-DHCI 4x5/8 4EA	9097052	EM-DHCI 4x5/8 4EB
6	7	54	12	6	4	9097021	EM-DHCI 6x7/12 4EA	9097054	EM-DHCI 6x7/12 4EB
8	9	58	16	8	4	9097022	EM-DHCI 8x9/16 4EA	9097055	EM-DHCI 8x9/16 4EB
10	11	66	20	10	4	9097023	EM-DHCI 10x11/20 4EA	9097056	EM-DHCI 10x11/20 4EB
12	12	73	24	12	4	9097024	EM-DHCI 12x12/24 4EA	9097057	EM-DHCI 12x12/24 4EB
14	14	75	28	14	4	9097025	EM-DHCI 14x14/28 4EA	9097058	EM-DHCI 14x14/28 4EB
16	16	82	32	16	4	9097026	EM-DHCI 16x16/32 4EA	9097059	EM-DHCI 16x16/32 4EB
20	20	92	40	20	4	9097028	EM-DHCI 20x20/40 4EA	9097061	EM-DHCI 20x20/40 4EB
lang long									
4	8	54	12	6	4	9096396	EM-DHCI 4x8/12 4EA	9096407	EM-DHCI 4x8/12 4EB
6	13	57	21	6	4	9096398	EM-DHCI 6x13/21 4EA	9096409	EM-DHCI 6x13/21 4EB
8	19	63	27	8	4	9096399	EM-DHCI 8x19/27 4EA	9096410	EM-DHCI 8x19/27 4EB
10	22	72	32	10	4	9096401	EM-DHCI 10x22/32 4EA	9096412	EM-DHCI 10x22/32 4EB
12	26	83	38	12	4	9096402	EM-DHCI 12x26/38 4EA	9096413	EM-DHCI 12x26/38 4EB
16	32	92	44	16	4	9096404	EM-DHCI 16x32/44 4EA	9096415	EM-DHCI 16x32/44 4EB
20	38	104	54	20	4	9096406	EM-DHCI 20x38/54 4EA	9096417	EM-DHCI 20x38/54 4EB

■ = Hauptanwendung First choice
□ = Nebenanwendung Second choice

Schnittwertempfehlungen ab Seite 70
Schnittwertempfehlungen für das Dynamische-/Trochoidal Fräsen ab Seite 158
Cutting data recommendations starting page 70
Cutting data recommendations for dynamic/trochoidal milling starting page 158

Kantenschutzfase Edge protection chamfer	d ₁	b
	4	0,1
	5	0,15
	6-12	0,2
	14-20	0,3



Fräsen mit Schlitzfräsen aus Vollhartmetall
Milling with solid carbide end mills

DHC INOX
Schnittwertempfehlungen
Cutting data recommendations

	Werkstoff	Material	Werkstoff-Nr. Material No.	DIN Bezeichnung Alt DIN Description Old	R_m/UTS (N/mm²)	DIN Bezeichnung Neu DIN Description New
M	Rost- und säurebeständiger Stahl, austenitisch	Stainless steel, austenitic	1.4301	X2CrNiMo17-12-2	500-950	X5CrNiMo18-10
			1.4404	X6CrNiMoTi17-12-2		X2CrNiMo17-12-2
			1.4571	X10CrNiMoTi18		X10CrNiMoTi18
	Rost- und säurebeständiger Stahl, ferritisch, martensitisch	Stainless steel, ferritic, martensitic	1.4024	X15Cr13	500-950	X15Cr13
			1.4057	X17CrNi16-2		X17CrNi16-2
			1.4122	X35CrMo17		X35CrMo17
	Rost- und säurebeständiger Stahl, martensitisch aushärtbar	Stainless steel, martensitic steel	1.2709	X3NiCoMoTi18-9-5	800-1000	X3NiCoMoTi18-9-5
			1.4542	X5CrNiCuNb16-4		X5CrNiCuNb16-4
			1.4568	X7CrNiAl17-7		X7CrNiAl17-7
N	Aluminium-Legierungen, kurzspanend	Aluminium alloys, short chipping	3.2581	G-AlSi12	-400	G-IGK-AlSi12
	Kupfer-Legierungen, kurzspanend	Copper alloys, short chipping	2.0402	MS58	-500	CuZn40Pb2
S	Titan-Legierungen, mittelfest	Titanium alloys, medium strength	3.7115	TiAl5Sn2,5	-950	TiAl5Sn2-5
			3.7164	TiAl6V4		TiAl6V4
	Titan-Legierungen, hochfest	Titanium alloys, high strength	3.7174	TiAl6Sn2	900-1400	TiAl6V6Sn2
	Nickelbasis-Legierungen, mittelfest	Nickel based alloys, medium strength	2.4670	NiCr12Al6MoNb	-950	NiCr12Al6MoNb
	Nickelbasis-Legierungen, hochwarmfest	Heat resistant nickel based alloys, high strength	2.4668	NiCr19Fe19NbMo	900-1400	Inconel 718 NiCr19Fe19Nb5Mo3

Die angegebenen Schnittwerte sind Startwerte und müssen auf die vorhandenen Bedingungen abgestimmt werden.
 The cutting data above are starting values and must be adjusted to the existing conditions.



Nassbearbeitung, auf ausreichende Emulsionszuführung achten
 Wet machining requires sufficient emulsion and volume

Vorschub-Korrektur-Faktoren f₁
Feed correction factor f₁



v_f = n · z · f_z · f₁			
a_e	a_p	DHC kurz short f₁	DHC lang long f₁
0,1 · d ₁	1 x d ₁	2	1,8
	1,5 x d ₁	-	1,7
	2 x d ₁ ¹⁾	-	1,6
0,25 · d ₁	1 x d ₁	2	1,4
	1,5 x d ₁	-	1,3
	2 x d ₁ ¹⁾	-	1,2
0,5 · d ₁	1 x d ₁	1,3	1,1
	1,5 x d ₁	-	1
	2 x d ₁ ¹⁾	-	0,8
0,75 · d ₁	1 x d ₁	1	0,8
	1,5 x d ₁	-	0,7
	2 x d ₁ ¹⁾	-	0,6
1 · d ₁	1 x d ₁	0,9	0,8
	1,5 x d ₁	0,8	0,7
	2 x d ₁ ¹⁾	-	0,6

Schnittgeschwindigkeit v_c ist um 30 % zu erhöhen
 The cutting speed v_c must be increased by 30 %

Schnittgeschwindigkeit v_c ist um 20 % zu reduzieren
 Reduce the cutting speed v_c by 20 %

- a_e = Schnittbreite in mm
Width of cut in mm
- a_p = Schnitttiefe in mm
Depth of cut in mm
- d₁ = Durchmesser in mm
Cutter diameter in mm
- f₁ = Korrekturfaktor für v_f
Correction factor for v_f
- f_z = Vorschub pro Zahn in mm
Feed per tooth in mm
- n = Drehzahl in min⁻¹
Speed in min⁻¹
- v_f = Vorschubgeschwindigkeit in mm/min
Feed rate in mm/min
- z = Anzahl der Schneiden
No. of teeth

¹⁾ 1,8 x d₁ für Durchmesser 14, 18, 20
 1.8 x d₁ for diameter 14, 18, 20

	Schnitt- geschwindigkeit Cutting speed v_c (m/min)	Kühlung Coolant 	Fräserdurchmesser Cutting diameter (mm)							
			Vorschub pro Zahn Feed per tooth f_z (mm/z.)							
			4	5	6	8	10	12	14-16	18-20
	100		0,02	0,03	0,03	0,04	0,05	0,05	0,07	0,08
	100		0,03	0,04	0,04	0,06	0,07	0,07	0,11	0,11
	120		0,03	0,03	0,03	0,05	0,07	0,07	0,10	0,10
	300		0,05	0,06	0,06	0,10	0,12	0,12	0,19	0,19
	250		0,04	0,05	0,05	0,08	0,10	0,10	0,16	0,16
	80		0,03	0,03	0,03	0,05	0,06	0,06	0,10	0,10
	60		0,02	0,02	0,02	0,04	0,04	0,04	0,06	0,06
	40		0,03	0,03	0,03	0,05	0,06	0,06	0,10	0,10
	30		0,02	0,02	0,02	0,04	0,04	0,04	0,06	0,06

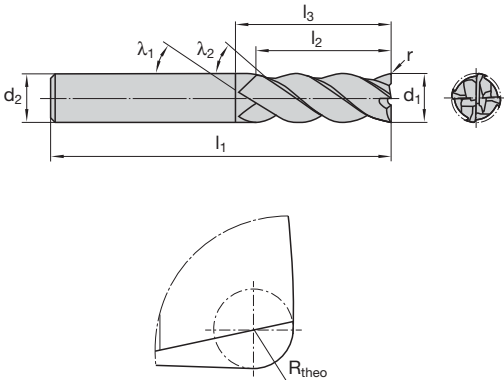

Katalog-Nr. Cat.-No.							1830C		1831C	
P										
M							■		■	
K										
N							□		□	
S							■		■	
H										
O										
d ₁	l ₂	l ₁	l ₃	d ₂	z	r _{theo} (+0,05)	Ident No.	LMT-Code	Ident No.	LMT-Code
kurz short										
4	5	54	8	6	4	0,15	7113848	EM-DHCIP 4x5/8 4R0.15A	7113858	EM-DHCIP 4x5/8 4R0.15B
5	6	54	10	6	4	0,2	7113849	EM-DHCIP 5x6/10 4R0.2A	7113859	EM-DHCIP 5x6/10 4R0.2B
6	7	54	16	6	4	0,3	7113850	EM-DHCIP 6x7/16 4R0.3A	7113860	EM-DHCIP 6x7/16 4R0.3B
8	9	58	20	8	4	0,3	7113851	EM-DHCIP 8x9/20 4R0.3A	7113861	EM-DHCIP 8x9/20 4R0.3B
10	11	66	24	10	4	0,3	7113852	EM-DHCIP 10x11/24 4R0.3A	7113862	EM-DHCIP 10x11/24 4R0.3B
12	12	73	26	12	4	0,3	7113853	EM-DHCIP 12x12/26 4R0.3A	7113863	EM-DHCIP 12x12/26 4R0.3B
14	14	75	28	16	4	0,4	7113854	EM-DHCIP 14x14/28 4R0.4A	7113864	EM-DHCIP 14x14/28 4R0.4B
16	16	82	32	16	4	0,4	7113855	EM-DHCIP 16x16/32 4R0.4A	7113865	EM-DHCIP 16x16/32 4R0.4B
18	18	84	34	18	4	0,4	7113856	EM-DHCIP 18x18/34 4R0.4A	7113866	EM-DHCIP 18x18/34 4R0.4B
20	20	92	40	20	4	0,4	7113857	EM-DHCIP 20x20/40 4R0.4A	7113867	EM-DHCIP 20x20/40 4R0.4B
lang long										
4	8	54	12	6	4	0,15	7113868	EM-DHCIP 4x8/12 4R0.15A	7113878	EM-DHCIP 4x8/12 4R0.15B
5	10	54	15	6	4	0,2	7113869	EM-DHCIP 5x10/15 4R0.2A	7113879	EM-DHCIP 5x10/15 4R0.2B
6	13	57	21	6	4	0,3	7113870	EM-DHCIP 6x13/21 4R0.3A	7113880	EM-DHCIP 6x13/21 4R0.3B
8	19	63	27	8	4	0,3	7113871	EM-DHCIP 8x19/27 4R0.3A	7113881	EM-DHCIP 8x19/27 4R0.3B
10	22	72	32	10	4	0,3	7113872	EM-DHCIP 10x22/32 4R0.3A	7113882	EM-DHCIP 10x22/32 4R0.3B
12	26	83	38	12	4	0,3	7113873	EM-DHCIP 12x26/38 4R0.3A	7113883	EM-DHCIP 12x26/38 4R0.3B
14	26	83	38	16	4	0,4	7113874	EM-DHCIP 14x26/38 4R0.4A	7113884	EM-DHCIP 14x26/38 4R0.4B
16	32	92	44	16	4	0,4	7113875	EM-DHCIP 16x32/44 4R0.4A	7113885	EM-DHCIP 16x32/44 4R0.4B
18	32	92	44	18	4	0,4	7113876	EM-DHCIP 18x32/44 4R0.4A	7113886	EM-DHCIP 18x32/44 4R0.4B
20	38	104	54	20	4	0,4	7113877	EM-DHCIP 20x38/54 4R0.4A	7113887	EM-DHCIP 20x38/54 4R0.4B

Schnittwertempfehlungen ab Seite 74

Schnittwertempfehlungen für das Dynamische-/Trochoidal Fräsen ab Seite 158

Cutting data recommendations starting page 74

Cutting data recommendations for dynamic/trochoidal milling starting page 158

■ = Hauptanwendung First choice

□ = Nebenanwendung Second choice

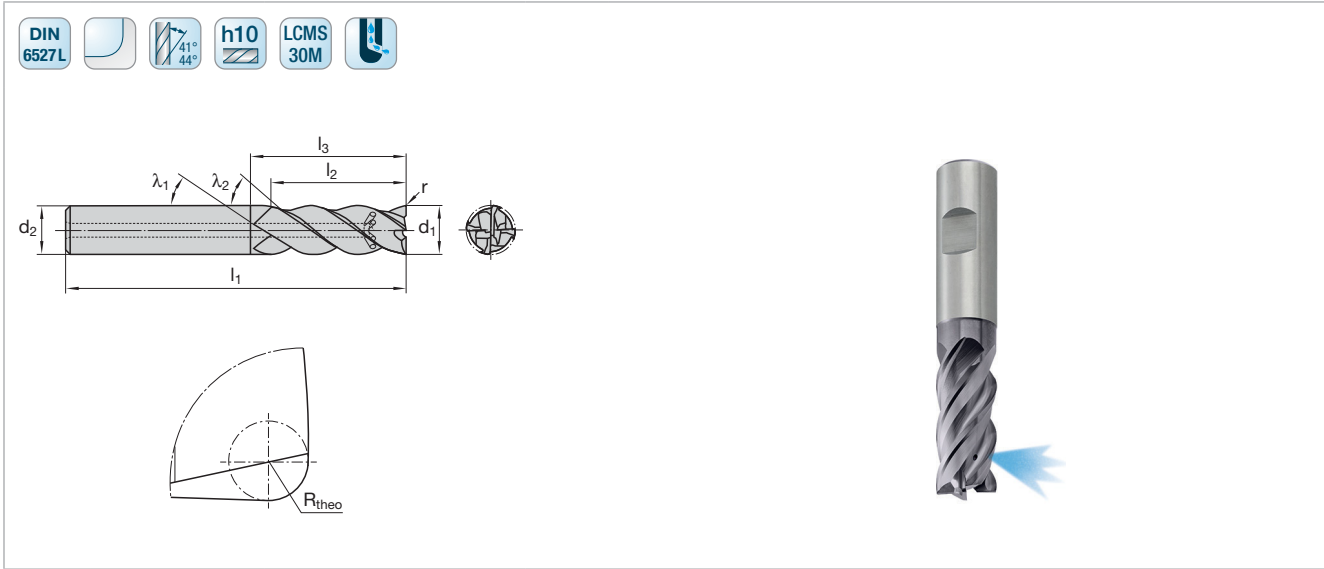

Katalog-Nr. Cat.-No.		1837C						
P								
M							■	
K								
N							■	
S							■	
H								
O								
d ₁	l ₂	l ₁	l ₃	d ₂	z	r _{theo} (+ 0,05)	Ident No.	LMT-Code
lang long								
6	13	57	21	6	4	0,3	7113888	EM-DHCIP 6x13/21 4R0.3B-I
8	19	63	27	8	4	0,3	7113889	EM-DHCIP 8x19/27 4R0.3B-I
10	22	72	32	10	4	0,3	7113890	EM-DHCIP 10x22/32 4R0.3B-I
12	26	83	38	12	4	0,3	7113891	EM-DHCIP 12x26/38 4R0.3B-I
16	32	92	44	16	4	0,4	7113892	EM-DHCIP 16x32/44 4R0.4B-I
20	38	104	54	20	4	0,4	7113893	EM-DHCIP 20x38/54 4R0.4B-I

Schnittwertempfehlungen ab Seite 74

Schnittwertempfehlungen für das Dynamische-/Trochoidal Fräsen ab Seite 158

Cutting data recommendations starting page 74

Cutting data recommendations for dynamic/trochoidal milling starting page 158

■ = Hauptanwendung First choice

□ = Nebenanwendung Second choice

DHC INOX Premium
Schnittwertempfehlungen
Cutting data recommendations

	Werkstoff	Material	Werkstoff-Nr. Material No.	DIN Bezeichnung Alt DIN Description Old	R_m/UTS (N/mm²)	DIN Bezeichnung Neu DIN Description New
M	Rost- und säurebeständiger Stahl, austenitisch	Stainless steel, austenitic	1.4301	X2CrNiMo17-12-2	500-950	X5CrNiMo18-10
			1.4404	X6CrNiMoTi17-12-2		X2CrNiMo17-12-2
			1.4571	X10CrNiMoTi18		X10CrNiMoTi18
	Rost- und säurebeständiger Stahl, ferritisch, martensitisch	Stainless steel, ferritic, martensitic	1.4024	X15Cr13	500-950	X15Cr13
			1.4057	X17CrNi16-2		X17CrNi16-2
			1.4122	X35CrMo17		X35CrMo17
	Rost- und säurebeständiger Stahl, martensitisch aushärtbar	Stainless steel, martensitic steel	1.2709	X3NiCoMoTi18-9-5	800-1000	X3NiCoMoTi18-9-5
			1.4542	X5CrNiCuNb16-4		X5CrNiCuNb16-4
			1.4568	X7CrNiAl17-7		X7CrNiAl17-7
N	Aluminium-Legierungen, kurzspanend	Aluminium alloys, short chipping	3.2581	G-AlSi12	-400	G-IGK-AlSi12
	Kupfer-Legierungen, kurzspanend	Copper alloys, short chipping	2.0402	MS58	-500	CuZn40Pb2
S	Titan-Legierungen, mittelfest	Titanium alloys, medium strength	3.7164	TiAl6V4	-950	Ti6AlV4
			3.7115	TiAl5Sn2,5		TiAl5Sn2-5
	Titan-Legierungen, hochfest	Titanium alloys, high strength	3.7174	TiAl6Sn2	900-1400	TiAl6V6Sn2
	Nickelbasis-Legierungen, mittelfest	Nickel based alloys, medium strength	2.4670	NiCr12Al6MoNb	-950	NiCr12Al6MoNb
	Nickelbasis-Legierungen, hochwarmfest	Heat resistant nickel based alloys, high strength	2.4668	NiCr19Fe19NbMo	900-1400	Inconel 718 NiCr19Fe19Nb5Mo3

Die angegebenen Schnittwerte sind Startwerte und müssen auf die vorhandenen Bedingungen abgestimmt werden.
 The cutting data above are starting values and must be adjusted to the existing conditions.

 Nassbearbeitung, auf ausreichende Emulsionszuführung achten
 Wet machining requires sufficient emulsion and volume

Vorschub-Korrektur-Faktoren f₁
Feed correction factor f₁

v_f = n · z · f_z · f₁			
a_e	a_p	DHC kurz short f₁	DHC lang long f₁
0,1 · d ₁	1 x d ₁	2	1,8
	1,5 x d ₁	-	1,7
	2 x d ₁ ¹⁾	-	1,6
0,25 · d ₁	1 x d ₁	1,7	1,4
	1,5 x d ₁	-	1,3
	2 x d ₁ ¹⁾	-	1,2
0,5 · d ₁	1 x d ₁	1,3	1,1
	1,5 x d ₁	-	1
	2 x d ₁ ¹⁾	-	0,8
0,75 · d ₁	1 x d ₁	1	0,8
	1,5 x d ₁	-	0,7
1 · d ₁	0,75 x d ₁	0,7	0,6

Schnittgeschwindigkeit v_c ist um 30 % zu erhöhen
 The cutting speed v_c must be increased by 30 %

Schnittgeschwindigkeit v_c ist um 20 % zu reduzieren
 Reduce the cutting speed v_c by 20 %

- a_e = Schnittbreite in mm
Width of cut in mm
- a_p = Schnitttiefe in mm
Depth of cut in mm
- d₁ = Durchmesser in mm
Cutter diameter in mm
- f₁ = Korrekturfaktor für v_f
Correction factor for v_f
- f_z = Vorschub pro Zahn in mm
Feed per tooth in mm
- n = Drehzahl in min⁻¹
Speed in min⁻¹
- v_f = Vorschubgeschwindigkeit in mm/min
Feed rate in mm/min
- z = Anzahl der Schneiden
No. of teeth

¹⁾ 1,8 x d₁ für Durchmesser 14, 18, 20
 1.8 x d₁ for diameter 14, 18, 20

Schnittgeschwindigkeit Cutting speed v_c (m/min)	Kühlung Coolant	Fräserdurchmesser Cutting diameter (mm)		
		Vorschub pro Zahn Feed per tooth f_z (mm/z.)		
		4-6	8-12	14-20
100-110		0,03	0,05	0,08
100		0,04	0,07	0,11
120-130		0,03	0,07	0,10
300-330		0,06	0,12	0,19
250-275		0,05	0,10	0,16
80-90		0,03	0,06	0,10
80-90		0,03	0,06	0,10
60-65		0,02	0,04	0,06
40-45		0,03	0,06	0,10
30-35		0,02	0,04	0,06

DHC INOX Premium

Merkmale und Vorteile

Features and benefits

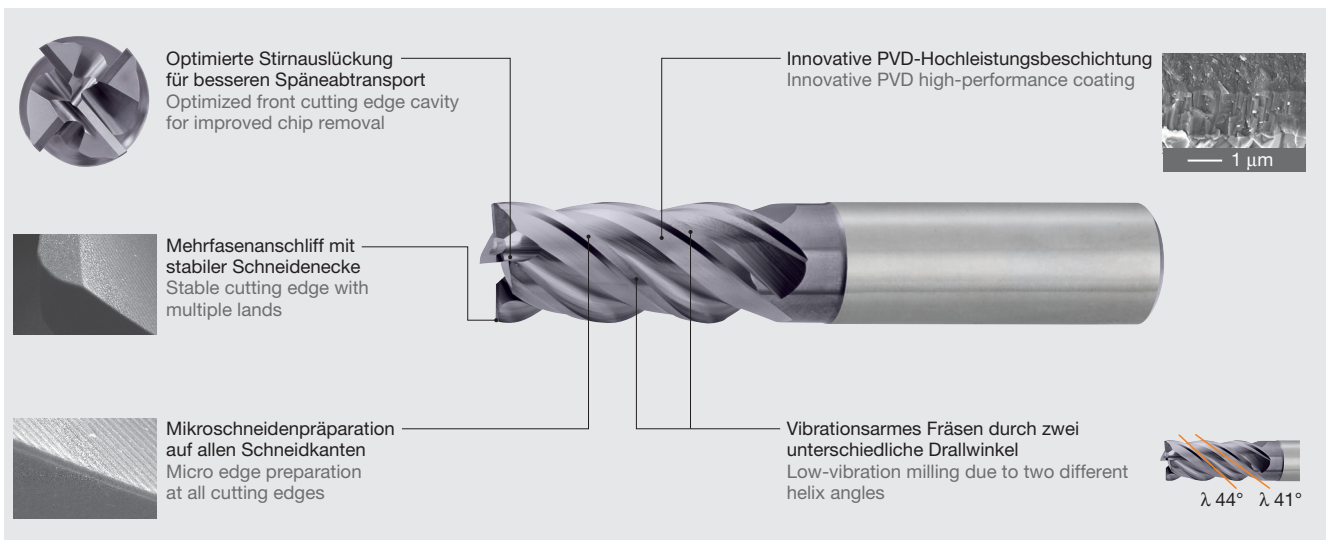

Vorteile:

- Min. 10 % höheres Zeitspanvolumen gegenüber der bisherigen Ausführung
- Gesteigerte Prozesssicherheit durch stabile Schneidkanten
- Schwingungsarm auf Grund unterschiedlicher Drallsteigung
- Multifunktional einsetzbar – Schruppen und Schlichten, Nuten fräsen und Ramping mit dem gleichen Werkzeug
- Gute Oberflächenqualität
- Großes Zeitspanvolumen, hohe Vorschübe
- Hohe Standzeit

Benefits:

- At least 10 % more machining volume compared with the previous DHC INOX range
- Increased process reliability thanks to stable cutting edges
- Low vibration due to varies helix angles
- Multi functional use – roughing and finishing, cutting of slots and ramping – all with one tool
- Excellent surface quality
- Large machining volume from high feed rates
- Longer tool life

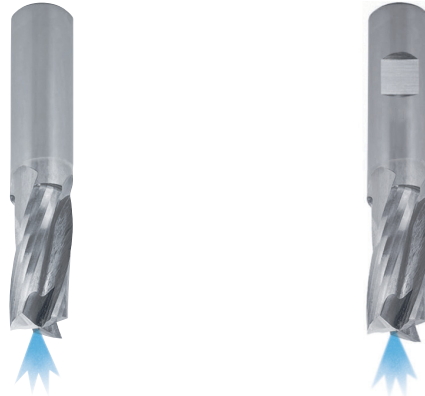
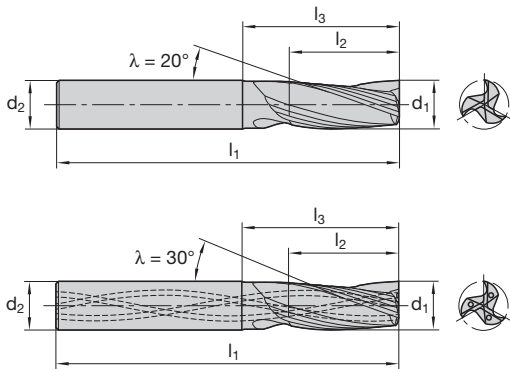

Katalog-Nr. Cat.-No.						1571		1572	
P									
M									
K									
N						■		■	
S									
H									
O									
d ₁	l ₂	l ₁	l ₃	d ₂	z	Ident No.	LMT-Code	Ident No.	LMT-Code
lang long									
ohne zentrale Innenkühlung without internal coolant λ = 20°									
4	11	57	21	6	2	1121971	EM-ASH 4x11/21 2SA	1121975	EM-ASH 4x11/21 2SB
5	13	57	21	6	2	1121972	EM-ASH 5x13/21 2SA	1121976	EM-ASH 5x13/21 2SB
6	13	57	21	6	2	1121973	EM-ASH 6x13/21 2SA	1121977	EM-ASH 6x13/21 2SB
8	19	63	27	8	2	1121909	EM-ASH 8x19/27 2SA	1121918	EM-ASH 8x19/27 2SB
10	22	72	32	10	2	1121910	EM-ASH 10x22/32 2SA	1121919	EM-ASH 10x22/32 2SB
12	26	83	38	12	3	1121911	EM-ASH 12x26/38 3SA	1121920	EM-ASH 12x26/38 3SB
14	26	83	38	14	3	1121912	EM-ASH 14x26/38 3SA	1121921	EM-ASH 14x26/38 3SB
16	32	92	44	16	3	1121913	EM-ASH 16x32/44 3SA	1121922	EM-ASH 16x32/44 3SB
18	32	92	44	18	3	1121916	EM-ASH 18x32/44 3SA	1121924	EM-ASH 18x32/44 3SB
20	38	104	54	20	3	1121917	EM-ASH 20x38/54 3SA	1121925	EM-ASH 20x38/54 3SB
25	45	121	65	25	3	1121974	EM-ASH 25x45/65 3SA	1121979	EM-ASH 25x45/65 3SB
mit zentraler Innenkühlung with internal coolant λ = 30°									
12	26	83	38	12	3	1110002	EM-ASH 12x26/38 3SA-I	1110008	EM-ASH 12x26/38 3SB-I
16	32	92	44	16	3	1110003	EM-ASH 16x32/44 3SA-I	1110009	EM-ASH 16x32/44 3SB-I
20	38	104	54	20	3	1110004	EM-ASH 20x38/54 3SA-I	1110010	EM-ASH 20x38/54 3SB-I

Schnittwertempfehlungen ab Seite 78
Cutting data recommendations starting page 78

■ = Hauptanwendung First choice
□ = Nebenanwendung Second choice

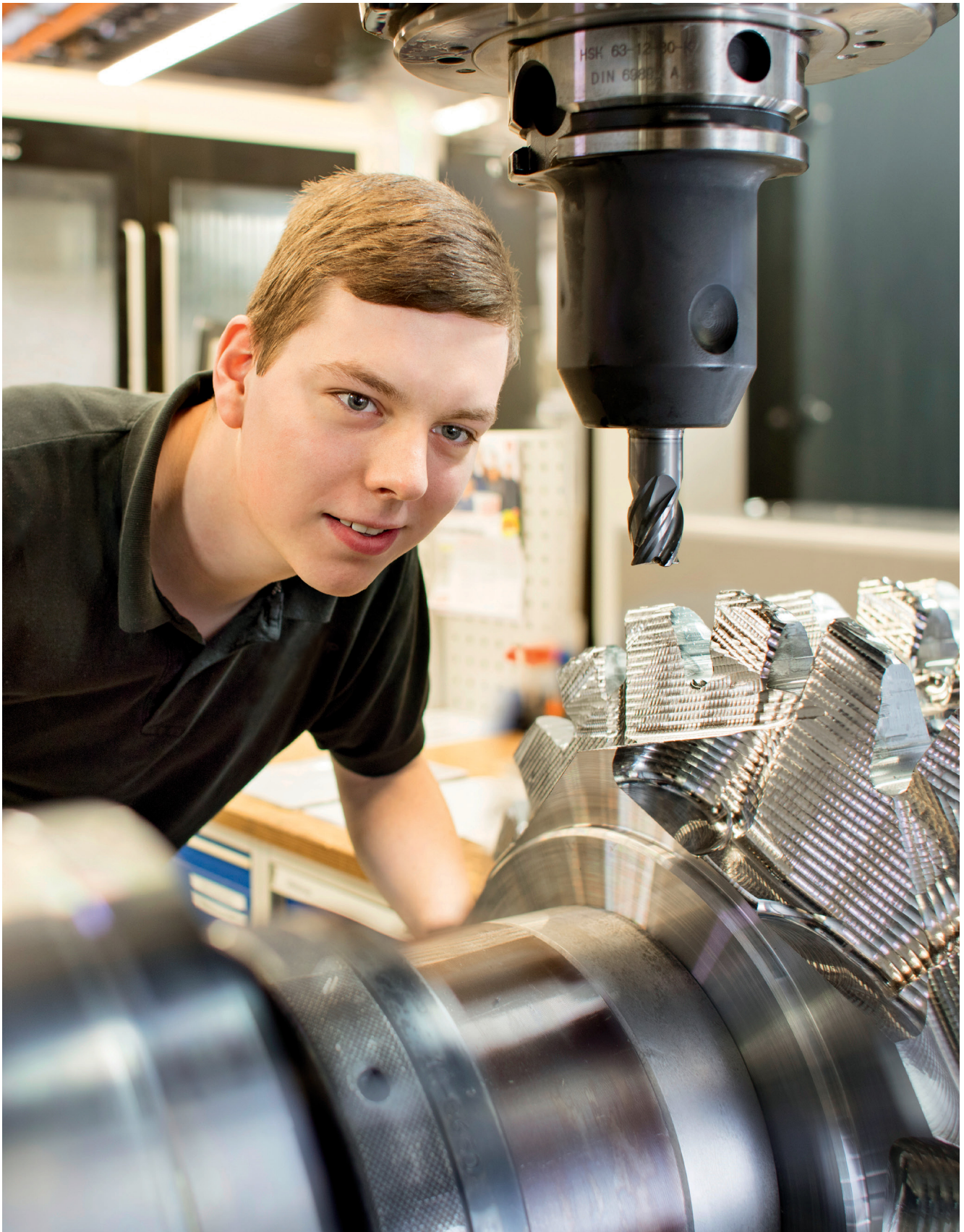

Fräsen mit Schlitfräsen aus Vollhartmetall
Milling with solid carbide end mills

AIRline
Schnittwertempfehlungen und Vorschübe für Schafffräser
Cutting data recommendations and feeds for end mills

	Werkstoff	Material	Werkstoff-Nr. Material No.	DIN Bezeichnung Alt DIN Description Old	R_m/UTS (N/mm²)	DIN Bezeichnung Neu DIN Description New
N	Rein-Metalle, weich	Pure metals, soft	1.1003	Reineisen, Blei Pure iron, lead	400–800	Reineisen, Blei Pure iron, lead
	Aluminium-Legierungen, kurzspanend	Aluminium alloys, short chipping	3.2581	G-AlSi12	–400	G-IGK-AlSi12
	Aluminium-Legierungen, langspanend	Aluminium alloys, long chipping	3.3535 3.4365	AlMg3 AlZnMgCu1,5	100–400	AlMg3 AlZnMgCu1,5
	Kupfer-Legierungen, kurzspanend	Copper alloys, short chipping	2.0402	MS58	–500	CuZn40Pb2
	Kupfer-Legierungen, langspanend	Copper alloys, long chipping	2.0320 2.0975	MS63 CuAl10Ni	150–250	CuZn37 CuAl10Fe5Ni5-C
	Magnesium-Legierungen	Magnesium alloys	3.5912	G-MgAl9Zn1	200–300	G-MgAl9Zn1
	Thermoplaste	Thermoplastics		PVC, Acrylglas PVC, acrylic glass	400–700	PVC, Acrylglas PVC, acrylic glass
	Duroplaste	Duroplastics		Bakelit, Melamin	20–40	Bakelit, Melamin

Die angegebenen Schnittwerte sind Startwerte und müssen auf die vorhandenen Bedingungen abgestimmt werden.
 The cutting data indicated are starting values and must be adjusted to the prevailing conditions.

 Nassbearbeitung, auf ausreichende Emulsionszuführung achten
 Wet machining, sufficient emulsion volume required

AIRline
Berechnungsformeln und Vorschubkorrekturfaktoren für Schafffräser
Calculating formulas and cutting speed correction factor end mills

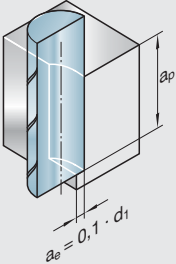
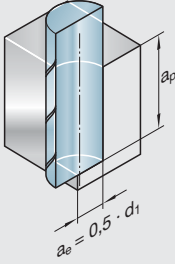
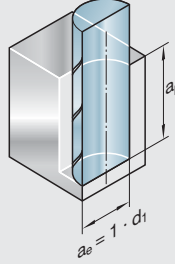
<p>Drehzahl Speed n (min⁻¹):</p> $n = \frac{v_c \cdot 1000}{\pi \cdot d_1}$	<p>Vorschubgeschwindigkeit Feed rate v_f (mm/min):</p> $v_f = f_z \cdot z \cdot n \cdot f_2$	<p>a_e = Schnittbreite Width of cut (mm) a_p = Schnitttiefe Depth of cut (mm) d₁ = Durchmesser Diameter (mm) f₂ = Korrekturfaktor für v_f Correction factor v_f f_z = Vorschub pro Zahn Feed per tooth (mm) n = Drehzahl Speed (min⁻¹) v_c = Schnittgeschwindigkeit Cutting speed (m/min) v_f = Vorschubgeschwindigkeit Feed rate (mm/min) z = Anzahl der Schneiden Number of teeth</p>		
<p>Vorschubkorrektur f₂ Cutting speed correction factor f₂</p> <p>Fräser mit Schrupp-Profil Milling cutters with roughing-profile</p>				<p>f₂ =</p> <p>1,0 0,8 0,6</p>

HM-Sorte Carbide grade	Schnitt- geschwindigkeit Cutting speed v_c (m/min)	Kühlung Coolant	Fräserdurchmesser Cutting diameter (mm)					
			Vorschub pro Zahn f_z bei Fräser-Ø Feed per tooth f_z for cutter diameter d_1 (mm)					
			Schruppen Roughing			Schlichten Finishing		
			8	12	16	8	12	16
LW 630	400		0,10	0,20	0,30	0,02	0,07	0,10
	280		0,10	0,20	0,30	0,06	0,08	0,12
	900		0,10	0,20	0,30	0,06	0,08	0,12
	280		0,10	0,20	0,30	0,05	0,07	0,10
	280		0,10	0,20	0,30	0,05	0,07	0,10
	500		0,10	0,20	0,30	0,06	0,08	0,12
	300		0,10	0,20	0,03	0,05	0,10	0,14
	300		0,10	0,20	0,30	0,05	0,10	0,14

Fräser mit Schlicht-Profil Milling cutters with finishing-profile			
$f_2 =$	1,0	0,6	0,5
Bohren auf volle Tiefe und anschließendes Längsfräsen Plunching to full depth and slotting		I. Bohren	II. Fräsen
$f_2 =$	0,3	0,5	

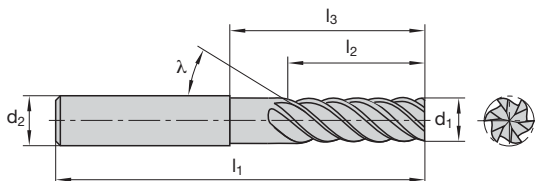

Katalog-Nr. Cat.-No.						1413C		1411C	
P						<input type="checkbox"/>		<input type="checkbox"/>	
M									
K						<input type="checkbox"/>		<input type="checkbox"/>	
N									
S									
H						<input checked="" type="checkbox"/>		<input checked="" type="checkbox"/>	
O									
d ₁	l ₂	l ₁	l ₃	d ₂	z	Ident No.	LMT-Code	Ident No.	LMT-Code
lang long									
2	7	38	15	3	4	9207422	EM-HSCSN 2x7/15 4SA	-	-
3	8	38	16	3	4	9207424	EM-HSCSN 3x8/16 4SA	-	-
3	8	57	16	6	4	-	-	9207360	EM-HSCSN 3x8/16 4SB
4	11	57	19	6	4	9207425	EM-HSCSN 4x11/19 4SA	9207389	EM-HSCSN 4x11/19 4SB
5	13	57	21	6	4	9207427	EM-HSCSN 5x13/21 4SA	9207391	EM-HSCSN 5x13/21 4SB
6	13	57	21	6	6	9207430	EM-HSCSN 6x13/21 6SA	9207395	EM-HSCSN 6x13/21 6SB
8	19	63	27	8	6	9207433	EM-HSCSN 8x19/27 6SA	9207396	EM-HSCSN 8x19/27 6SB
10	22	72	32	10	6	9207438	EM-HSCSN 10x22/32 6SA	9207397	EM-HSCSN 10x22/32 6SB
12	26	83	38	12	8	9207445	EM-HSCSN 12x26/38 8SA	9207398	EM-HSCSN 12x26/38 8SB
16	32	92	44	16	8	9207451	EM-HSCSN 16x32/44 8SA	9207399	EM-HSCSN 16x32/44 8SB
20	38	104	54	20	8	9207457	EM-HSCSN 20x38/54 8SA	9207421	EM-HSCSN 20x38/54 8SB

Schnittwertempfehlungen ab Seite 82
 Cutting data recommendations starting page 82

■ = Hauptanwendung First choice
 □ = Nebenanwendung Second choice

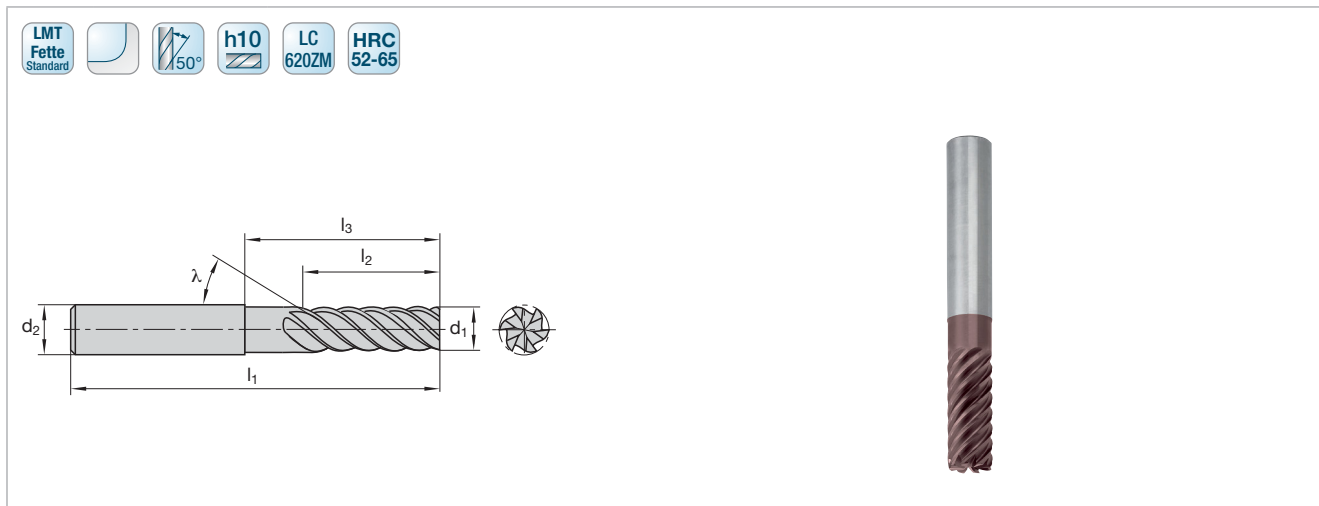

Katalog-Nr. Cat.-No.		1443C						
P		<input type="checkbox"/>						
M		<input type="checkbox"/>						
K		<input type="checkbox"/>						
N		<input type="checkbox"/>						
S		<input type="checkbox"/>						
H		<input checked="" type="checkbox"/>						
O		<input type="checkbox"/>						
d ₁	l ₂	l ₁	l ₃	d ₂	z	r	Ident No.	LMT-Code
lang long								
3	8	57	16	6	4	0,3	9207458	EM-HSCSN 3x8/16 4R0.3A
4	11	57	19	6	4	0,3	9207472	EM-HSCSN 4x11/19 4R0.3A
5	13	57	21	6	4	0,5	9207476	EM-HSCSN 5x13/21 4R0.5A
6	13	57	21	6	6	0,5	9207478	EM-HSCSN 6x13/21 6R0.5A
6	13	57	21	6	6	1	9207480	EM-HSCSN 6x13/21 6R1A
8	19	63	27	8	6	0,5	9207482	EM-HSCSN 8x19/27 6R0.5A
8	19	63	27	8	6	1	9207483	EM-HSCSN 8x19/27 6R1A
10	22	72	32	10	6	0,5	9207486	EM-HSCSN 10x22/32 6R0.5A
10	22	72	32	10	6	1	9207488	EM-HSCSN 10x22/32 6R1A
10	22	72	32	10	6	2	9207507	EM-HSCSN 10x22/32 6R2A
12	26	83	38	12	8	0,5	9207508	EM-HSCSN 12x26/38 8R0.5A
12	26	83	38	12	8	1	9207509	EM-HSCSN 12x26/38 8R1A
12	26	83	38	12	8	1,5	9207510	EM-HSCSN 12x26/38 8R1.5A
16	32	92	44	16	8	1	9207522	EM-HSCSN 16x32/44 8R1A
16	32	92	44	16	8	2	9207523	EM-HSCSN 16x32/44 8R2A
20	38	104	54	20	8	1	9207524	EM-HSCSN 20x38/54 8R1A

Schnittwertempfehlungen ab Seite 82
 Cutting data recommendations starting page 82

■ = Hauptanwendung First choice
 □ = Nebenanwendung Second choice

HSCline

Schnittwertempfehlungen für Schafffräser Typ SN, mit Eckenradius und gerader Stirn

Cutting data recommendations for end mills type SN, with corner radius and straight corner

	Werkstoff	Material	Werkstoff-Nr. Material No.	DIN Bezeichnung Alt DIN Description Old	Härte Hardness	DIN Bezeichnung Neu DIN Description New
P	Vergütbare Formenstähle	Heat-treatable die steels	1.2311	40CrMnMo7	280–325 HB	40CrMnMo7
			1.2312	40CrMnMoS8.6	280–325 HB	40CrMnMoS8-6
			1.2738	40CrMnNiMoS8.6.4	280–325 HB	40CrMnNiMoS8-6-4
			1.2711	54NiCrMoV6	280–415 HB	54NiCrMoV6
	Durchhärtende Werkzeugstähle	Full hardening tools steels	1.2343	X38CrMoV5 1	230 HB	X37CrMoV5 1
			1.2080	X210Cr12	250 HB	X210Cr12
			1.2379	X155CrVMo12 1	250 HB	X153CrVMo12 1
			1.2767	X45NiCrMo4	260 HB	X45NiCrMo4
	Nitrierstähle	Nitriding steels	1.8550	34CrAlNi7	240–300 HB	34CrAlNi7
			1.8519	31CrMoV9	265–310 HB	31CrMoV9
			1.7735	14CrMoV6.9	265–310 HB	14CrMoV6.9
			1.2344	X40CrMoV5.1	280–325 HB	X40CrMoV5-1
K	Grauguss	Grey cast iron	0.6025	GG25	100–400 (120–260 HB)	EN-GJl-250
	Legierter Grauguss	Alloyed grey cast iron	0.6678	GGL-NiCr35 2	150–250 (160–230 HB)	EN-GJLA-XNiCr35-2
	Sphäroguss	Nodular cast iron	0.7060 0.7070	GGG60 GGG70L	400–800 (120–310 HB)	EN-GJS-600-3 EN-GJS-700-2U
	Temperguss	Malleable cast iron	0.8155	GTS55	350–700 (150–280 HB)	EN-GJMB-550-4
H	Gehärteter Stahl	Hardened steel			45–52 HRC	
					53–56 HRC	
					57–62 HRC	
					63–68 HRC	

Die angegebenen Schnittwerte sind Startwerte und müssen auf die vorhandenen Bedingungen abgestimmt werden.

Bei der langen Ausführung empfehlen wir die f_z -Werte um 30% zu reduzieren.

The cutting data specified represents base values and must be adapted to the existing conditions.

For high values of total feed we recommend reducing the specified unit values of feed (f_z) by 30%.

Anwendungsbeispiel

Application example

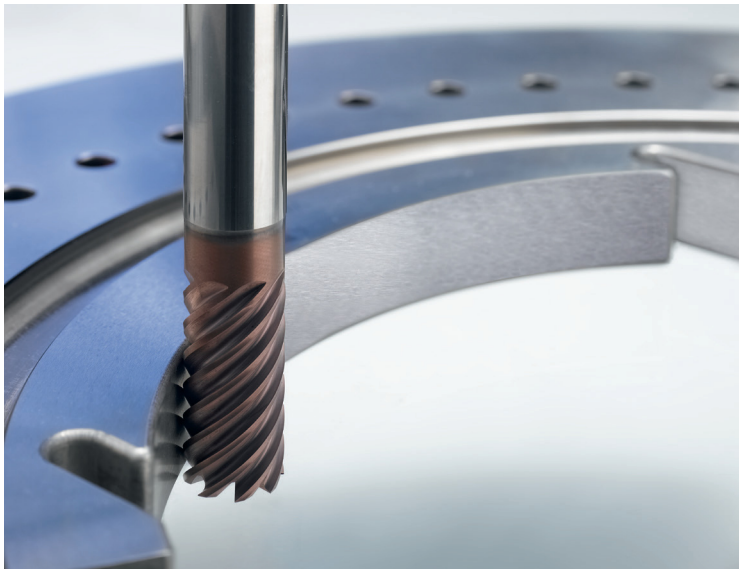

Umfangsfraßen mit hoher Oberflächengüte (trocken) Finish milling with high surface quality (dry)

Werkzeug Tool:

HSCline Schafffräser, Typ HSC SN
HSCline end mill, type HSC SN
1413 C | $d_1 = 20$ mm, $z = 8$
Nanosphere Red LC620ZM

Werkstoff Material:

M390 (57–58 HRC)

Schnittwerte Cutting data:

$v_c = 200$ m/min
 $n = 3200$ min⁻¹
 $v_f = 1460$ mm/min
 $f_z = 0,057$ mm
 $a_e = 0,2$ mm
 $a_p = 25$ mm

	Schnitt- geschwindigkeit Cutting speed v_c (m/min)	Fräserdurchmesser Cutting diameter (mm)										Schnitttiefe Cutting depth a_e (mm)
		Vorschub pro Zahn Feed per tooth f_z (mm/z.)										
		2	3	4	5	6	8	10	12	16	20	
	200	0,01	0,015	0,02	0,025	0,03	0,04	0,05	0,06	0,08	0,09	0,08 x d_1
	220	0,01	0,015	0,02	0,025	0,03	0,04	0,05	0,06	0,08	0,09	
	180	0,006	0,009	0,012	0,015	0,018	0,024	0,03	0,036	0,048	0,054	
	200	0,008	0,012	0,016	0,02	0,024	0,032	0,04	0,048	0,056	0,072	0,06 x d_1
	200	0,01	0,015	0,02	0,025	0,03	0,04	0,05	0,06	0,07	0,09	
	160	0,006	0,009	0,012	0,015	0,018	0,024	0,03	0,036	0,042	0,054	
	160	0,006	0,009	0,012	0,015	0,018	0,024	0,03	0,036	0,042	0,054	0,08 x d_1
	200	0,008	0,012	0,016	0,02	0,024	0,032	0,04	0,048	0,064	0,072	
	180	0,006	0,009	0,012	0,015	0,018	0,024	0,03	0,036	0,048	0,054	
	200	0,006	0,004	0,012	0,015	0,018	0,024	0,03	0,036	0,048	0,054	0,06 x d_1
	200	0,008	0,012	0,016	0,02	0,024	0,032	0,04	0,048	0,056	0,072	
	200	0,01	0,015	0,02	0,025	0,03	0,04	0,05	0,06	0,07	0,09	
	240	0,015	0,02	0,025	0,035	0,045	0,055	0,07	0,09	0,10	0,11	0,06 x d_1
	220	0,01	0,015	0,02	0,03	0,04	0,05	0,06	0,07	0,08	0,09	
	220	0,01	0,015	0,02	0,03	0,04	0,05	0,06	0,07	0,08	0,09	
	200	0,01	0,015	0,02	0,025	0,035	0,045	0,055	0,065	0,07	0,08	0,04 x d_1
	180	0,006	0,009	0,012	0,015	0,018	0,024	0,03	0,036	0,048	0,054	
	150	0,006	0,008	0,011	0,014	0,017	0,022	0,028	0,034	0,045	0,05	
	120	0,005	0,008	0,01	0,013	0,015	0,02	0,025	0,03	0,04	0,045	0,02 x d_1
	100	0,005	0,007	0,01	0,012	0,014	0,019	0,024	0,029	0,038	0,043	0,01 x d_1

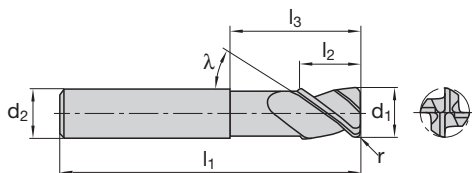

Katalog-Nr. Cat.-No.							1450C	
P							<input type="checkbox"/>	
M								
K							<input type="checkbox"/>	
N								
S								
H							<input checked="" type="checkbox"/>	
O								
d ₁	l ₂	l ₁	l ₃	d ₂	z	r	Ident No.	LMT-Code
kurz short								
1	1	38	2,2	3	2	0,2	9207530	EM-HSCH 1x1/2.2 2R0.2A
2	2	50	3,6	6	2	0,3	9207551	EM-HSCH 2x2/3.6 2R0.3A
3	3	50	5,5	6	2	0,4	9207553	EM-HSCH 3x3/5.5 2R0.4A
4	4	57	14,5	6	4	0,5	9207554	EM-HSCH 4x4/14.5 4R0.5A
4	4	57	14,5	6	4	1	9207555	EM-HSCH 4x4/14.5 4R1A
5	5	57	21	6	4	0,5	9207557	EM-HSCH 5x5/21 4R0.5A
5	5	57	21	6	4	1	9207558	EM-HSCH 5x5/21 4R1A
6	6	57	21	6	4	0,5	9207562	EM-HSCH 6x6/21 4R0.5A
6	6	57	21	6	4	1	9207564	EM-HSCH 6x6/21 4R1A
8	8	63	27	8	4	1	9207567	EM-HSCH 8x8/27 4R1A
8	8	63	27	8	4	1,5	9207568	EM-HSCH 8x8/27 4R1.5A
8	8	63	27	8	4	2	9207569	EM-HSCH 8x8/27 4R2A
8	8	63	27	8	4	0,5	9207565	EM-HSCH 8x8/27 4R0.5A
10	10	72	32	10	4	0,5	9207582	EM-HSCH 10x10/32 4R0.5A
10	10	72	32	10	4	1	9207583	EM-HSCH 10x10/32 4R1A
10	10	72	32	10	4	1,5	9207584	EM-HSCH 10x10/32 4R1.5A
10	10	72	32	10	4	2	9207585	EM-HSCH 10x10/32 4R2A
12	12	83	38	12	4	1,5	9207596	EM-HSCH 12x12/38 4R1.5A
12	12	83	38	12	4	2	9207597	EM-HSCH 12x12/38 4R2A
12	12	83	38	12	4	0,5	9207587	EM-HSCH 12x12/38 4R0.5A
12	12	83	38	12	4	1	9207590	EM-HSCH 12x12/38 4R1A
12	12	83	38	12	4	2	9207597	EM-HSCH 12x12/38 4R2A
lang long								
4	4	80	19	6	4	0,5	9207599	EM-HSCH 4x4/19 4R0.5A
4	4	80	19	6	4	1	9207600	EM-HSCH 4x4/19 4R1A
5	5	80	44	6	4	1	9207604	EM-HSCH 5x5/44 4R1A
5	5	80	44	6	4	0,5	9207603	EM-HSCH 5x5/44 4R0.5A
6	6	80	44	6	4	0,5	9207605	EM-HSCH 6x6/44 4R0.5A
6	6	80	44	6	4	1	9207606	EM-HSCH 6x6/44 4R1A
8	8	90	54	8	4	0,5	9207608	EM-HSCH 8x8/54 4R0.5A

Schnittwertempfehlungen ab Seite 86
Cutting data recommendations starting page 86

■ = Hauptanwendung First choice
□ = Nebenanwendung Second choice



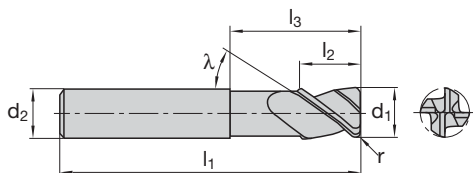

Katalog-Nr. Cat.-No.							1450C		
P								<input type="checkbox"/>	
M									
K								<input type="checkbox"/>	
N									
S									
H								<input checked="" type="checkbox"/>	
O									
d ₁	l ₂	l ₁	l ₃	d ₂	z	r	Ident No.	LMT-Code	
lang long									
8	8	90	54	8	4	1	9207609	EM-HSCH 8x8/54 4R1A	
8	8	90	54	8	4	1,5	9207611	EM-HSCH 8x8/54 4R1.5A	
8	8	90	54	8	4	2	9207613	EM-HSCH 8x8/54 4R2A	
10	10	100	60	10	4	0,5	9207616	EM-HSCH 10x10/60 4R0.5A	
10	10	100	60	10	4	1	9207622	EM-HSCH 10x10/60 4R1A	
10	10	100	60	10	4	1,5	9207627	EM-HSCH 10x10/60 4R1.5A	
10	10	100	60	10	4	2	9207628	EM-HSCH 10x10/60 4R2A	
12	12	110	65	12	4	0,5	9207630	EM-HSCH 12x12/65 4R0.5A	
12	12	110	65	12	4	1	9207631	EM-HSCH 12x12/65 4R1A	
12	12	110	65	12	4	1,5	9207632	EM-HSCH 12x12/65 4R1.5A	
12	12	110	65	12	4	2	9207633	EM-HSCH 12x12/65 4R2A	

Schnittwertempfehlungen ab Seite 86
 Cutting data recommendations starting page 86

■ = Hauptanwendung First choice
 □ = Nebenanwendung Second choice

HSCLine

Schnittwertempfehlungen für Schafffräser Typ H, gerade und runde Stirn

Cutting data recommendations for end mills type H, straight corner or ball nose

	Werkstoff	Material	Werkstoff-Nr. Material No.	DIN Bezeichnung Alt DIN Description Old	Härte Hardness	DIN Bezeichnung Neu DIN Description New
P	Vergütbare Formenstähle	Heat-treatable die steels	1.2311	40CrMnMo7	280–325 HB	40CrMnMo7
			1.2312	40CrMnMoS8.6	280–325 HB	40CrMnMoS8-6
			1.2738	40CrMnNiMoS8.6.4	280–325 HB	40CrMnNiMoS8-6-4
			1.2711	54NiCrMoV6	280–415 HB	54NiCrMoV6
	Durchhärtende Werkzeugstähle	Full hardening tools steels	1.2343	X38CrMoV5 1	230 HB	X37CrMoV5 1
			1.2080	X210Cr12	250 HB	X210Cr12
			1.2379	X155CrVMo12 1	250 HB	X153CrVMo12 1
			1.2767	X45NiCrMo4	260 HB	X45NiCrMo4
	Nitrierstähle	Nitriding steels	1.8550	34CrAlNi7	240–300 HB	34CrAlNi7
			1.8519	31CrMoV9	265–310 HB	31CrMoV9
			1.7735	14CrMoV6.9	265–310 HB	14CrMoV6.9
			1.2344	X40CrMoV5.1	280–325 HB	X40CrMoV5-1
K	Grauguss	Grey cast iron	0.6025	GG25	100–400 (120–260 HB)	EN-GJI-250
	Legierter Grauguss	Alloyed grey cast iron	0.6678	GGL-NiCr35 2	150–250 (160–230 HB)	EN-GJLA-XNiCr35-2
	Sphäroguss	Nodular cast iron	0.7060 0.7070	GGG60 GGG70L	400–800 (120–310 HB)	EN-GJS-600-3 EN-GJS-700-2U
	Temperguss	Malleable cast iron	0.8155	GTS55	350–700 (150–280 HB)	EN-GJMB-550-4
H	Gehärteter Stahl	Hardened steel			45–52 HRC	
					53–56 HRC	
					57–62 HRC	
					63–68 HRC	

	Schnitt- geschwindigkeit Cutting speed v_c (m/min)	Fräserdurchmesser Cutting diameter (mm)								
		Vorschub pro Zahn Feed per tooth f_z (mm/z.)								
		1	2	3	4	5	6	8	10	12
	200–260	0,01	0,02	0,03	0,04	0,05	0,06	0,08	0,10	0,12
	220–280	0,012	0,024	0,036	0,05	0,06	0,07	0,10	0,12	0,14
	180–240	0,008	0,016	0,024	0,03	0,04	0,05	0,06	0,08	0,10
	200–260	0,012	0,024	0,036	0,05	0,06	0,07	0,10	0,12	0,14
	190–250	0,012	0,024	0,036	0,05	0,06	0,07	0,10	0,12	0,14
	160–220	0,008	0,016	0,024	0,03	0,04	0,05	0,06	0,08	0,10
	160–200	0,007	0,014	0,02	0,03	0,04	0,04	0,06	0,07	0,08
	200–260	0,01	0,02	0,03	0,04	0,05	0,06	0,08	0,10	0,12
	160–220	0,008	0,016	0,024	0,03	0,04	0,05	0,06	0,08	0,10
	180–240	0,008	0,016	0,024	0,03	0,04	0,05	0,06	0,08	0,10
	200–260	0,008	0,016	0,024	0,03	0,04	0,05	0,06	0,08	0,10
	200–260	0,012	0,024	0,036	0,05	0,06	0,072	0,10	0,12	0,14
	200–300	0,012	0,02	0,03	0,045	0,06	0,07	0,10	0,125	0,15
	180–280	0,01	0,018	0,025	0,04	0,055	0,065	0,09	0,115	0,13
	160–260	0,01	0,018	0,025	0,04	0,055	0,065	0,09	0,115	0,13
	140–240	0,01	0,018	0,025	0,04	0,055	0,065	0,09	0,115	0,13
	160–200	0,008	0,016	0,024	0,03	0,04	0,05	0,06	0,08	0,10
	120–150	0,006	0,012	0,018	0,02	0,03	0,04	0,05	0,06	0,07
	80–120	0,005	0,01	0,014	0,02	0,023	0,03	0,04	0,05	0,05
	60–100	0,004	0,007	0,011	0,014	0,018	0,02	0,03	0,035	0,04

DHC HARDLINE Schruppfräsen bei voller Härte Roughing with full hardness



Der DHC HARDLINE von LMT Fette findet überall dort Anwendung, wo hochfeste Werkstoffe bis 1600 N/mm² oder gehärteter Stahl von 45 bis 55 HRC bearbeitet werden.

Seine ungleiche Teilung sorgt für höchste Laufruhe und Prozesssicherheit. Er ist ideal geeignet für die HSC-Bearbeitung oder für trochoidales Fräsen und zeigt seine Stärke auch beim Kanten-, Eck- und Nutenfräsen sowie beim Bohren bis 0,5 x Durchmesser. Der Hauptnutzen des DHC HARDLINE für den Anwender besteht in der sehr guten Oberflächenqualität der Werkstücke sowie in der Standzeiterhöhung von bis zu 60 % gegenüber vergleichbaren Wettbewerbsprodukten.

Das Werkzeug ist im Durchmesserbereich von 6–20 mm verfügbar, sowie in den zwei verschiedenen Schneidenlängen kurz und lang.

The DHC HARDLINE by LMT Fette is used wherever high strength materials up to 1600 N/mm² or hardened steel from 45 up to 55 HRC are processed.

The unequal splits of its cutting edges ensure a maximum in balanced running and process safety. It suits perfectly for HSC machining or trochoidal milling and also comes into its prime when milling edges, shoulders and slots as well as drilling up to 0.5 x its diameter. The main user benefit of the DHC HARDLINE is an excellent surface quality on the work piece and an enhancement of the tool life up to 60 % compared to similar competitor products.

The tool is available in a diameter range from 6–20 mm and in the two different cutting lengths short and long.

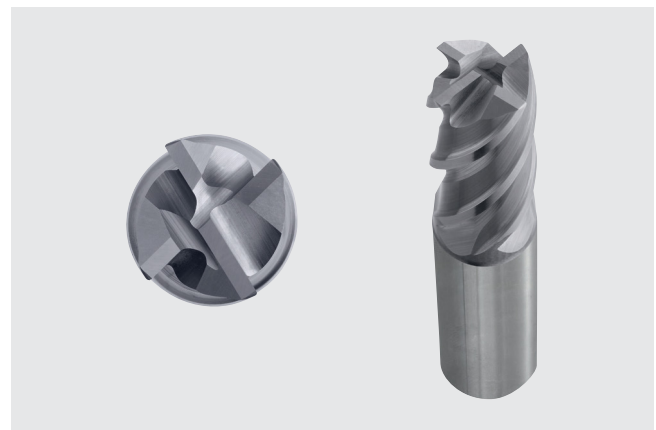

Anwendungsbeispiel Application example



Maschinenbau General Machining Segment Matrizenscheibe Segment turret

Werkzeug Tool:

DHC HARDLINE Schaftfräser, lang
DHC HARDLINE end mill, long
Kat.-Nr. Cat.-No. 1841C, d₁ = 12 mm, z = 4

Schneidstoff Cutting material:

LCHP20M

Werkstoff Material:

Werkzeugstahl Sleiþner 47–50 HRC
Tool steel Sleiþner 47–50 HRC

Schnittwerte Cutting data:

v _c = 250 m/min	v _f = 1860 mm/min
n = 6630 min ⁻¹	a _e = 2 mm
f _z = 0,07 mm	a _p = 12,5 mm

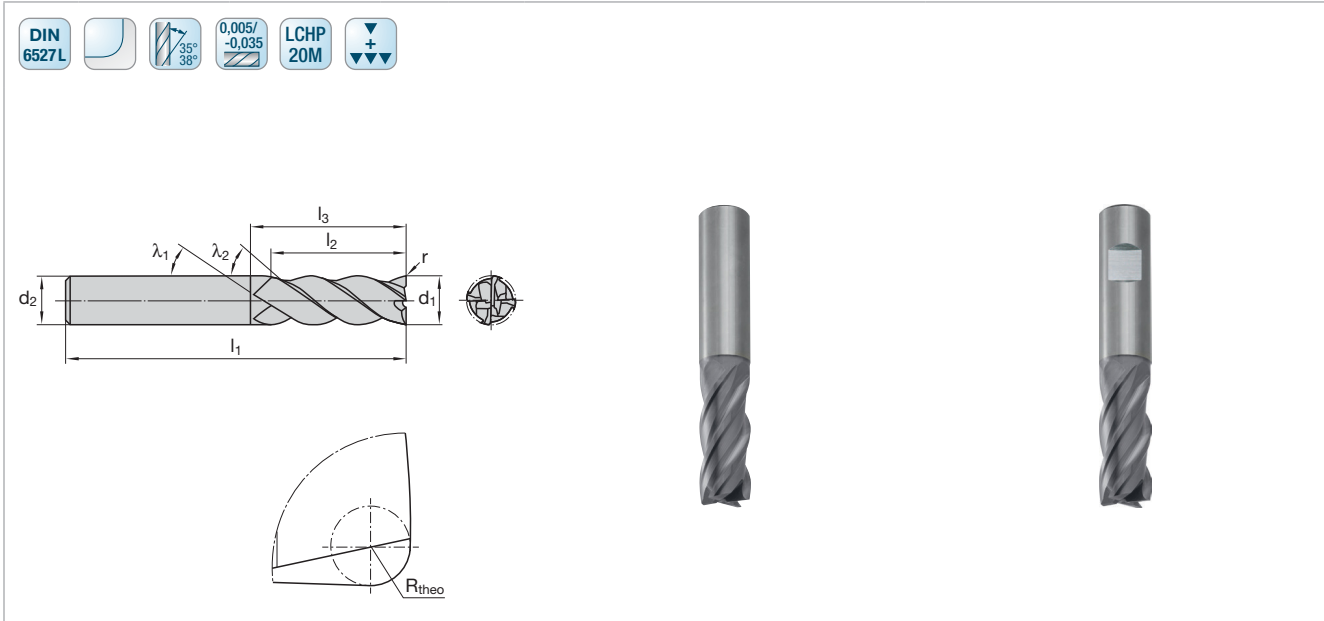

Katalog-Nr. Cat.-No.								1840C		1841C	
P								■		■	
M											
K								□		□	
N											
S											
H								■		■	
O											
d ₁	l ₂	l ₁	l ₃	d ₂	z	R _{theo} (± 0,1)	Ident No.	LMT-Code	Ident No.	LMT-Code	
kurz short											
6	7	54	16	6	4	0,5	7146639	EM-DHCH 6x7/16 4R0.5A	7146648	EM-DHCH 6x7/16 4R0.5B	
8	9	58	20	8	4	0,5	7146640	EM-DHCH 8x9/20 4R0.5A	7146649	EM-DHCH 8x9/20 4R0.5B	
10	11	66	24	10	4	0,5	7146641	EM-DHCH 10x11/24 4R0.5A	7146650	EM-DHCH 10x11/24 4R0.5B	
12	12	73	26	12	4	0,5	7146642	EM-DHCH 12x12/26 4R0.5A	7146651	EM-DHCH 12x12/26 4R0.5B	
12	12	73	26	12	4	1	7146643	EM-DHCH 12x12/26 4R1A	7146652	EM-DHCH 12x12/26 4R1B	
16	16	82	32	16	4	0,5	7146644	EM-DHCH 16x16/32 4R0.5A	7146653	EM-DHCH 16x16/32 4R0.5B	
16	16	82	32	16	4	1	7146645	EM-DHCH 16x16/32 4R1A	7146654	EM-DHCH 16x16/32 4R1B	
20	20	92	40	20	4	0,5	7146646	EM-DHCH 20x20/40 4R0.5A	7146655	EM-DHCH 20x20/40 4R0.5B	
20	20	92	40	20	4	1	7146647	EM-DHCH 20x20/40 4R1A	7146656	EM-DHCH 20x20/40 4R1B	
lang long											
6	15	57	21	6	4	0,5	7146657	EM-DHCH 6x15/21 4R0.5A	7146666	EM-DHCH 6x15/21 4R0.5B	
8	20	63	27	8	4	0,5	7146658	EM-DHCH 8x20/27 4R0.5A	7146667	EM-DHCH 8x20/27 4R0.5B	
10	25	72	32	10	4	0,5	7146659	EM-DHCH 10x25/32 4R0.5A	7146668	EM-DHCH 10x25/32 4R0.5B	
12	30	83	38	12	4	0,5	7146660	EM-DHCH 12x30/38 4R0.5A	7146669	EM-DHCH 12x30/38 4R0.5B	
12	30	83	38	12	4	1	7146661	EM-DHCH 12x30/38 4R1A	7146670	EM-DHCH 12x30/38 4R1B	
16	35	92	44	16	4	0,5	7146662	EM-DHCH 16x35/44 4R0.5A	7146671	EM-DHCH 16x35/44 4R0.5B	
16	35	92	44	16	4	1	7146663	EM-DHCH 16x35/44 4R1A	7146672	EM-DHCH 16x35/44 4R1B	
20	44	104	54	20	4	0,5	7146664	EM-DHCH 20x44/54 4R0.5A	7146673	EM-DHCH 20x44/54 4R0.5B	
20	44	104	54	20	4	1	7146665	EM-DHCH 20x44/54 4R1A	7146674	EM-DHCH 20x44/54 4R1B	

Schnittwertempfehlungen ab Seite 90

Schnittwertempfehlungen für das Dynamische-/Trochoidal Fräsen ab Seite 158

Cutting data recommendations starting page 90

Cutting data recommendations for dynamic/trochoidal milling starting page 158

■ = Hauptanwendung First choice

□ = Nebenanwendung Alternative

DHC HARDLINE
Schnittwertempfehlungen
Cutting data recommendations

	Werkstoff	Material	Werkstoff-Nr. Material No.	DIN Bezeichnung Alt DIN Description Old	R_m/UTS (N/mm²)	DIN Bezeichnung Neu DIN Description New
P	Nitrier- und Vergütungsstahl	Nitriding steel and heat-treatment steel	1.7225	42CrMo4	950–1400	42CrMo4
			1.2344	X40CrMoV5.1	–900	X40CrMoV5-1
			1.4104	X12CrMoS17	500–950	X14CrMoS17
			1.8504	34CrAl6	950–1400	34CrAl6
	Werkzeugstahl	Tool steel	1.2343	X38CrMoV5 1	950–1400	X37CrMoV5-1
			1.6580	30CrNiMo8	950–1400	30CrNiMo8
			1.2379	X155CrVMo12 1	–950	X153CrMoV12-1
			1.2080	X210Cr12	950–1400	X210Cr12
			1.2311	40CrMnMo7	–1100	40CrMnMo7
			1.2312	40CrMnNiMoS8.6	–1150	40CrMnNiMoS8-6
			1.2738	45CrMnNiMo8.6.4	950–1150	45CrMnNiMo8-6-4
			1.2358	60CrMoV18-5	850–1000	60CrMoV18-5
			1.2714	55NiCrMoV7	1100–1350	55NiCrMoV7
K	Grauguss	Grey cast iron	0.6025	GG25	100–400 (120–260 HB)	EN-GJI-250
	Legierter Grauguss	Alloyed grey cast iron	0.6678	GGL-NiCr35 2	150–250 (160–230 HB)	EN-GJLA-XNiCr35-2
	Sphäroguss	Nodular cast iron	0.7060 0.7070	GGG60 GGG70L	400–800 (120–310 HB)	EN-GJS-600-3 EN-GJS-700-2U
	Temperguss	Malleable cast iron	0.8155	GTS55	350–700 (150–280 HB)	EN-GJMB-550-4
H	Hartguss	Chilled cast iron		Ni-hard, Ampco	300–600 HB	Ni-hard, Ampco
	Gehärteter Stahl	Hardened steel		Sleipner, Toolox	45–49 HRC	Sleipner, Toolox
				Dievar	50–53 HRC	Dievar
				Vandis, Sverker	54–55 HRC	Vandis, Sverker

Die angegebenen Schnittwerte sind Startwerte und müssen auf die vorhandenen Bedingungen abgestimmt werden.
 The cutting data indicated are starting values based and must be adjusted to the prevailing conditions.

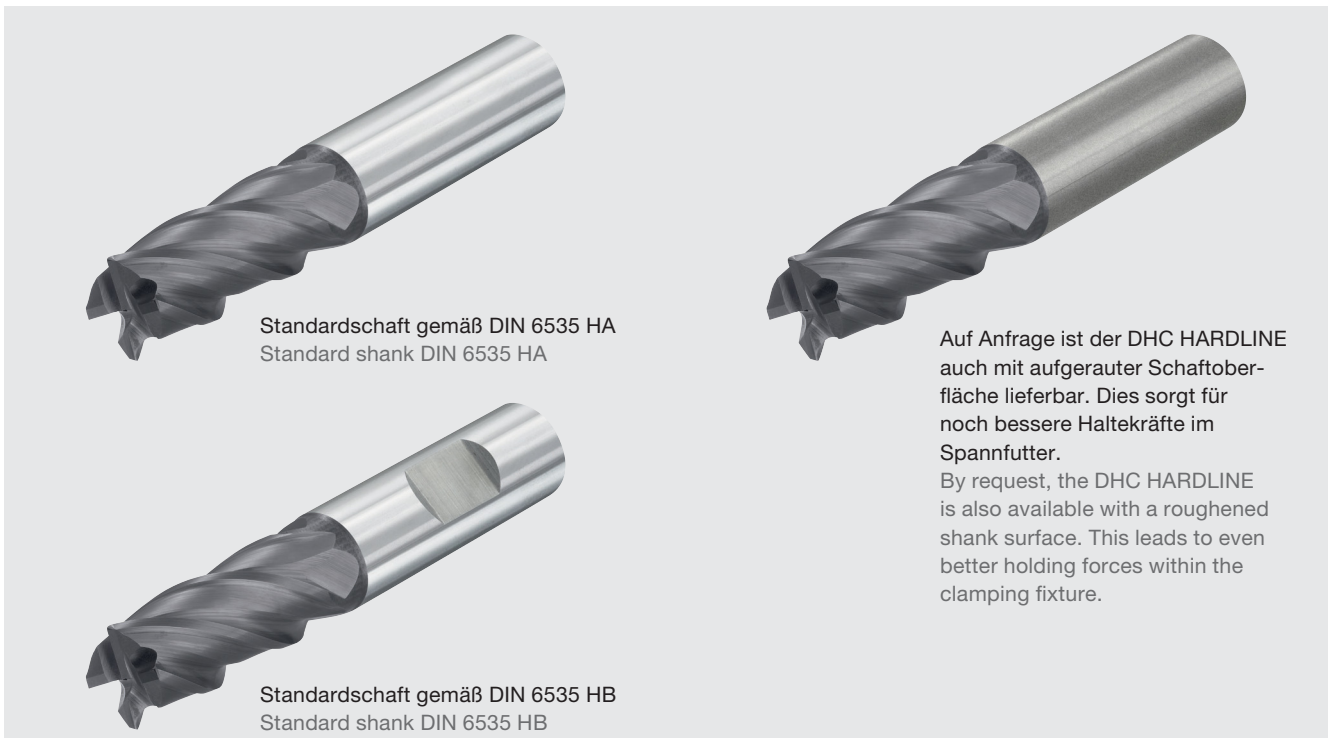

Schnittgeschwindigkeit Cutting speed v_c (m/min)	Fräserdurchmesser Cutting diameter (mm)					
	Vorschub pro Zahn Feed per tooth f_z (mm/z.)					
	Kantenfräsen Shoulder milling			Vollnutfräsen Slot milling		
	\varnothing 6-8	\varnothing 10-12	\varnothing 16-20	\varnothing 6-8	\varnothing 10-12	\varnothing 16-20
120-140	0,04-0,06	0,06-0,08	0,15-0,18	0,03-0,05	0,04-0,06	0,08-0,10
120-140	0,04-0,06	0,06-0,08	0,15-0,18	0,03-0,05	0,04-0,06	0,08-0,10
120-140	0,04-0,06	0,06-0,08	0,15-0,18	0,03-0,05	0,04-0,06	0,08-0,10
120-140	0,04-0,06	0,06-0,08	0,15-0,18	0,03-0,05	0,04-0,06	0,08-0,10
100-120	0,03-0,05	0,05-0,08	0,12-0,15	0,02-0,03	0,04-0,05	0,08-0,10
120-140	0,03-0,05	0,05-0,08	0,12-0,15	0,02-0,03	0,04-0,05	0,08-0,10
100-120	0,03-0,05	0,05-0,08	0,12-0,15	0,02-0,03	0,04-0,05	0,08-0,10
100-120	0,03-0,05	0,05-0,08	0,12-0,15	0,02-0,03	0,04-0,05	0,08-0,10
120-140	0,03-0,05	0,05-0,08	0,12-0,15	0,02-0,03	0,04-0,05	0,08-0,10
140-160	0,03-0,05	0,05-0,08	0,12-0,15	0,02-0,03	0,04-0,05	0,08-0,10
120-140	0,03-0,05	0,05-0,08	0,12-0,15	0,02-0,03	0,04-0,05	0,08-0,10
100-120	0,03-0,05	0,05-0,08	0,12-0,15	0,02-0,03	0,04-0,05	0,08-0,10
100-120	0,03-0,05	0,05-0,08	0,12-0,15	0,02-0,03	0,04-0,05	0,08-0,10
180-220	0,09-0,12	0,15-0,18	0,22-0,28	0,05-0,06	0,08-0,09	0,11-0,14
160-180	0,08-0,11	0,13-0,16	0,20-0,26	0,04-0,06	0,07-0,08	0,10-0,13
150-180	0,07-0,10	0,12-0,14	0,19-0,24	0,04-0,05	0,06-0,07	0,09-0,12
120-150	0,07-0,10	0,12-0,14	0,19-0,24	0,04-0,05	0,06-0,07	0,09-0,12
80-100	0,01-0,02	0,02-0,03	0,04-0,05	0,01-0,02	0,01-0,02	0,02-0,04
100-120	0,02-0,03	0,04-0,05	0,08-0,10	0,02-0,03	0,04-0,05	0,06-0,08
80-100	0,01-0,02	0,02-0,03	0,06-0,08	0,01-0,02	0,02-0,03	0,04-0,06
80	0,01-0,02	0,02-0,03	0,05-0,06	0,01-0,02	0,02-0,03	0,04-0,05

Vorschub-Korrekturfaktoren f_1 Feed correction factor f_1							
	a_e	a_p	DHC HARDLINE kurz short	DHC HARDLINE lang long	a_p	DHC HARDLINE kurz short	DHC HARDLINE lang long
			f_1	f_1		f_1	f_1
$0,1 \cdot d_1$	$1 \times d_1$	2	1,8	-	-	-	
	$1,5 \times d_1$	-	1,6	-	-	-	
	$2 \times d_1$	-	1,4	-	-	-	
$0,25 \cdot d_1$	$1 \times d_1$	1,9	1,4	-	-	-	
	$1,5 \times d_1$	-	1,2	-	-	-	
	$2 \times d_1$	-	1	-	-	-	
$0,5 \cdot d_1$	$1 \times d_1$	1,4	1	-	-	-	
	$1,5 \times d_1$	-	0,8	-	-	-	
	$2 \times d_1$	-	0,6	-	-	-	
$0,75 \cdot d_1$	$1 \times d_1$	0,9	0,6	-	-	-	
	$1,5 \times d_1$	-	0,5	-	-	-	
$1 \cdot d_1$	-	-	-	$0,5 \times d_1$	1,4	1,2	
	-	-	-	$1 \times d_1$	1,2	1	

Trockenbearbeitung, auf ausreichende Pressluftzuführung achten
 Dry machining, mind sufficient air-blast cooling

Nutenbearbeitung mit ausreichend Pressluftzufuhr um Spänestau zu vermeiden
 Slot milling, sufficient air-blast cooling avoids chip congestion

HSCline SuperFinish2 | SuperFinish4 Kopierfräser für allerhöchste Ansprüche Copy milling cutter to fit highest requirements



Für die Entwicklung des VHM-Schaftfräsers mit 2 oder neu 4 Schneiden und runder Stirn wurde sowohl das Know-how der Werkzeugexperten von LMT Fette als auch LMT Kieninger aufgegriffen. Das bereits bestehende Werkzeugprogramm wurde hierzu einer detaillierten Prüfung unterzogen. Bei der neuen Entwicklung wurden zahlreiche Verbesserungen umgesetzt.

Der HSCline SuperFinish2 und SuperFinish4 setzt Maßstäbe in Präzision sowie Prozesssicherheit und Standzeit. Darüber hinaus garantieren die angegebenen Schnittwerte ein Höchstmaß an Produktivität.

Der Erfolg lässt sich durch die bekannten Parameter Geometrie, Substrat und Beschichtung leicht beschreiben:

- Optimierte Geometrie mit sehr engen Fertigungstoleranzen für höchste Präzision im Einsatz
- Hochwertiges Substrat für hohe Schnittgeschwindigkeiten (Werkstoffe bis 65 HRC) und kürzere Bearbeitungszeiten
- Ausgereifte Beschichtung mit hoher Verschleißbeständigkeit für stabile Fertigungsprozesse

The know-how of the tool experts at LMT Fette as well as at LMT Kieninger was called upon to develop the solid carbide end mill with 2 or new 4 cutting edges and a round face. In conjunction with this, the new existing tool range underwent a close check. Numerous improvements were implemented in the newly developed tool.

The HSCline SuperFinish2 and SuperFinish4 sets new standards with regard to precision, process reliability and service life. In addition, the specified cutting values ensure maximum productivity.

The success is easy to describe by means of the well-known parameters geometry, substrate and coating:

- Optimized geometry with very narrow manufacturing tolerances for maximum precision during use
- High quality substrate for high cutting speeds (materials up to 65 HRC) and shorter processing times
- Highly developed coating with high wear resistance for stable manufacturing processes

HSCline SuperFinish2 | SuperFinish4 Eigenschaften auf einen Blick Features at a glance

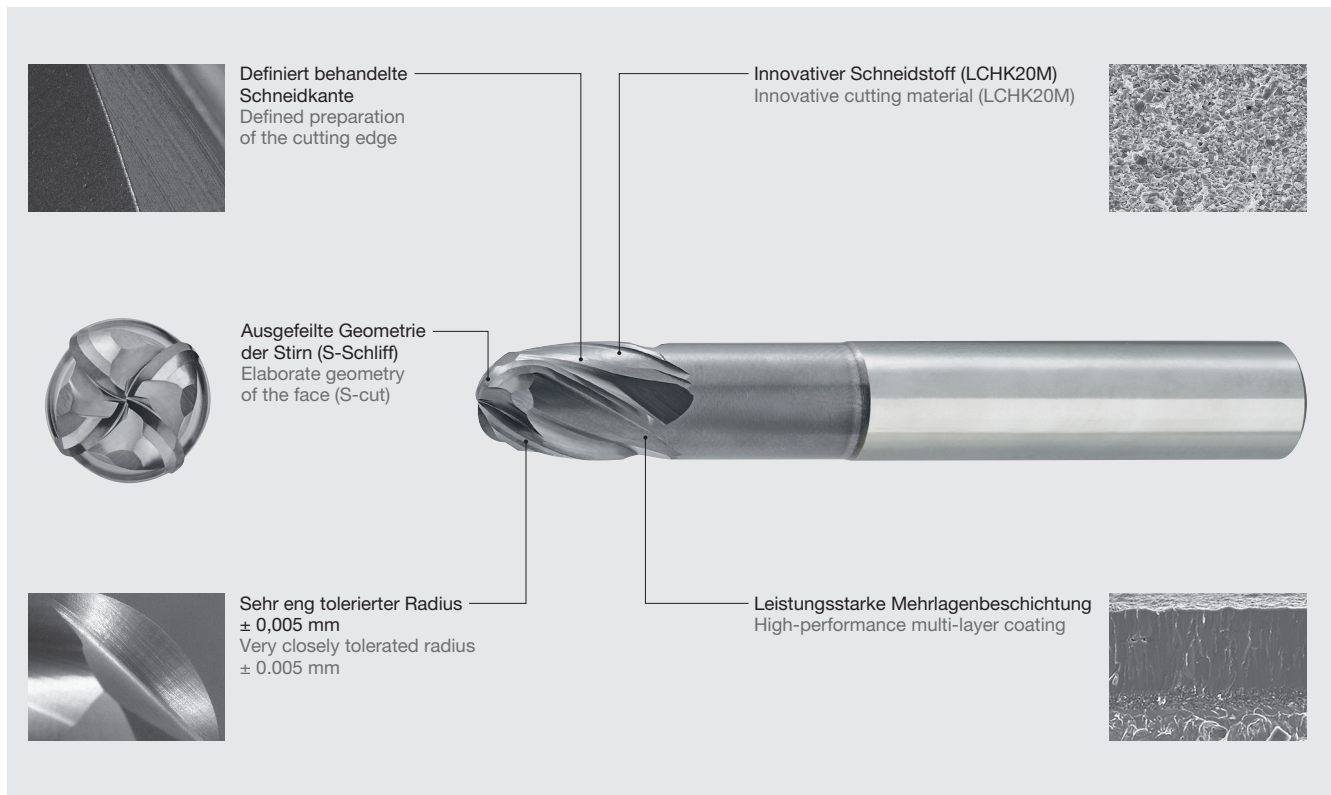

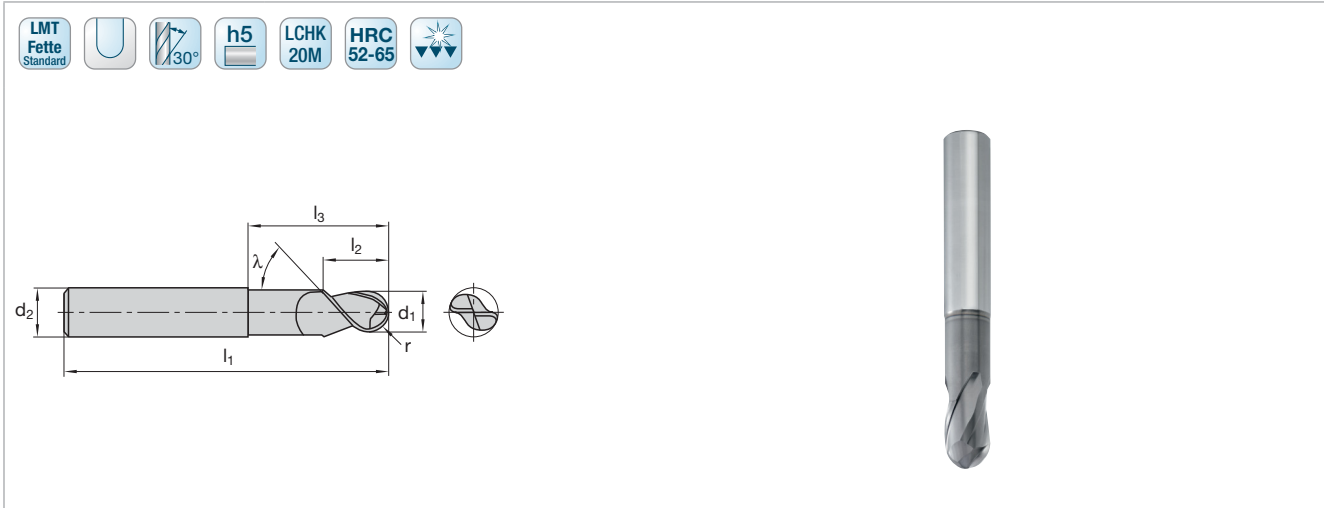

Katalog-Nr. Cat.-No.							1854C	
P							<input type="checkbox"/>	
M								
K							<input type="checkbox"/>	
N								
S								
H							<input checked="" type="checkbox"/>	
O								
d ₁	l ₂	l ₁	l ₃	d ₂	z	r	Ident No.	LMT-Code
kurz short								
4	5	57	14,5	6	2	2	7172234	EM-HSCSF2 4x5/57 2BA
6	7,5	57	21	6	2	3	7172235	EM-HSCSF2 6x7.5/57 2BA
8	10	63	27	8	2	4	7172236	EM-HSCSF2 8x10/63 2BA
10	12,5	72	32	10	2	5	7172237	EM-HSCSF2 10x12.5/72 2BA
12	15	83	38	12	2	6	7172238	EM-HSCSF2 12x15/83 2BA
lang long								
4	5	80	19	6	2	2	7172239	EM-HSCSF2 4x5/80 2BA
6	7,5	90	54	6	2	3	7172240	EM-HSCSF2 6x7.5/90 2BA
8	10	100	64	8	2	4	7172241	EM-HSCSF2 8x10/100 2BA
10	12,5	100	60	10	2	5	7172242	EM-HSCSF2 10x12.5/100 2BA
12	15	110	65	12	2	6	7172243	EM-HSCSF2 12x15/110 2BA

Schnittwertempfehlungen ab Seite 96
 Cutting data recommendations starting page 96

= Hauptanwendung First choice
 = Nebenanwendung Alternative

Der S-Schliff im Zentrum der Stirnschneide ermöglicht optimale Schnittwerte und garantiert beste Oberflächengüten.

The S-cut in the center of the front cutting edge enables optimized cutting data to ensure high class surface qualities.

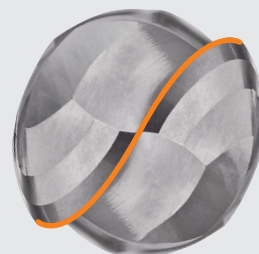

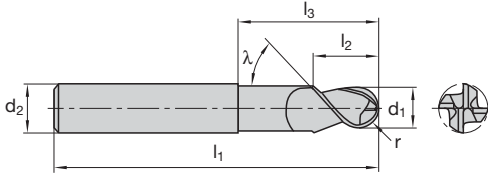

Katalog-Nr. Cat.-No.							1864C	
P							<input type="checkbox"/>	
M								
K							<input type="checkbox"/>	
N								
S								
H							<input checked="" type="checkbox"/>	
O								
d ₁	l ₂	l ₁	l ₃	d ₂	z	r	Ident No.	LMT-Code
kurz short								
6	7,5	57	21	6	4	3	7172244	EM-HSCSF4 6x7.5/57 4BA
8	10	63	27	8	4	4	7172245	EM-HSCSF4 8x10/63 4BA
10	12,5	72	32	10	4	5	7172246	EM-HSCSF4 10x12.5/72 4BA
12	15	83	38	12	4	6	7172247	EM-HSCSF4 12x15/83 4BA
lang long								
6	7,5	90	54	6	4	3	7172248	EM-HSCSF4 6x7.5/90 4BA
8	10	100	64	8	4	4	7172249	EM-HSCSF4 8x10/100 4BA
10	12,5	100	60	10	4	5	7172250	EM-HSCSF4 10x12.5/100 4BA
12	15	110	65	12	4	6	7172251	EM-HSCSF4 12x15/110 4BA

Schnittwertempfehlungen ab Seite 96
 Cutting data recommendations starting page 96

■ = Hauptanwendung First choice
 □ = Nebenanwendung Alternative

Der S-Schliff im Zentrum der Stirnschneide ermöglicht optimale Schnittwerte und garantiert beste Oberflächengüten.

The S-cut in the center of the front cutting edge enables optimized cutting data to ensure high class surface qualities.

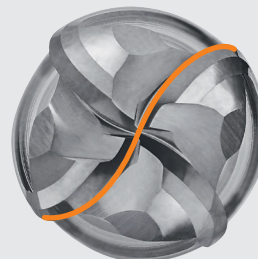

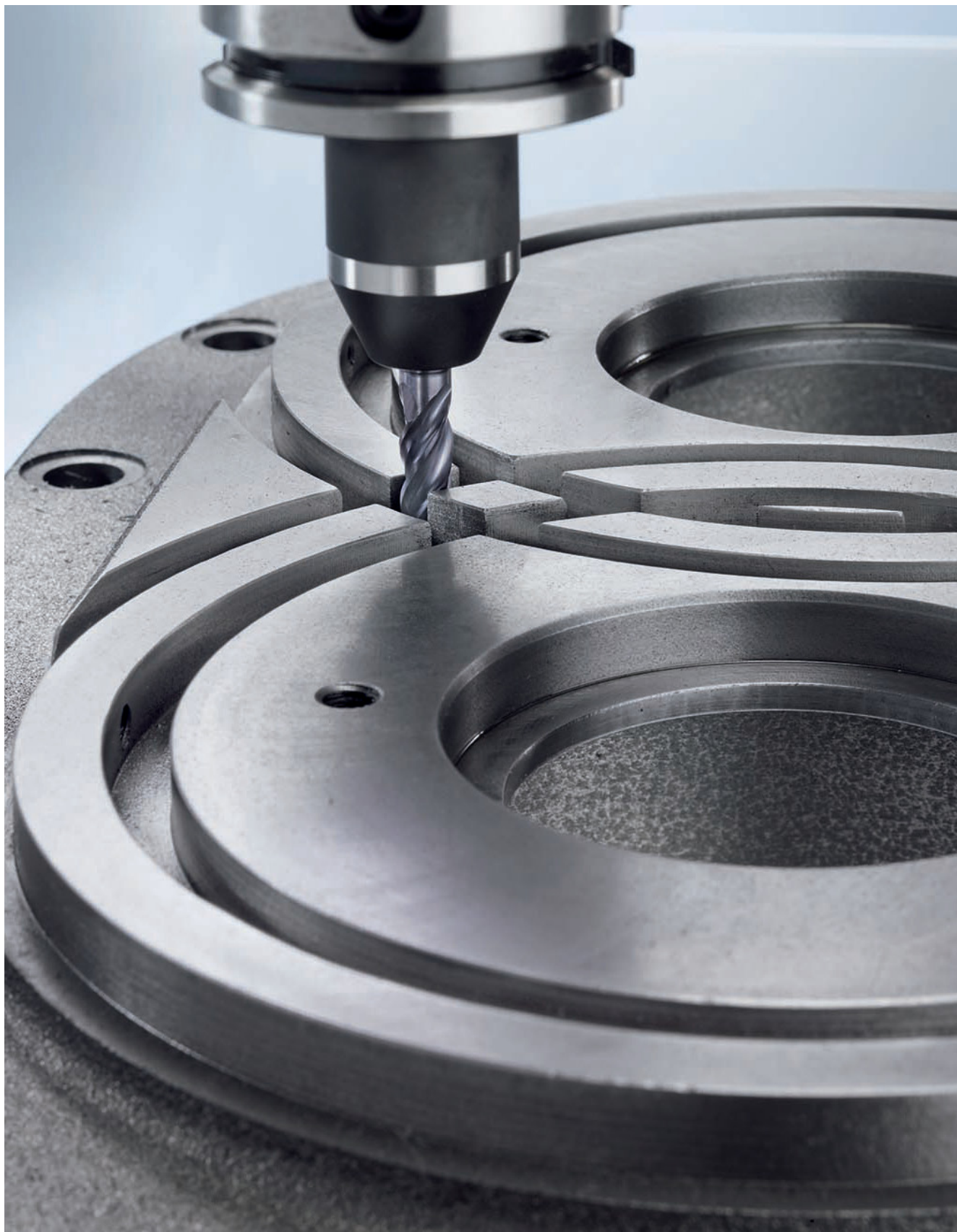

Fräsen mit Schlitfräsen aus Vollhartmetall
Milling with solid carbide end mills

	Werkstoff	Material	Werkstoff-Nr. Material No.	Zugfestigkeit oder Härte (N/mm²)	DIN Bezeichnung Alt DIN Description Old	Schnitt- geschwindigkeit Cutting speed v_c (m/min)
P	Vergütbare Formenstähle	Heat-treatable die steels	1.2311	950–1150	40CrMnMo7	230–280
			1.2312	950–1150	40CrMnNiMoS8-6	260–300
			1.2738	950–1150	45CrMnNiMo8-6-4	230–300
			1.2711	950–1400	54NiCrMoV6	220–280
	Durchhärtende Werkzeugstähle	Full hardening tools steels	1.2358	850–1000	60CrMoV18-5	230–280
			1.2343	–950	X37CrMoV5 1	250–300
			1.2080	–850	X210Cr12	220–280
			1.2379	–850	X153CrVMo12 1	230–280
	Nitrierstähle	Nitriding steels	1.2767	–900	X45NiCrMo4	250–300
			1.8550	800–1000	34CrAlNi7	220–280
1.8519			850–1050	31CrMoV9	240–320	
1.7735			850–1050	14CrMoV6.9	260–350	
K	Grauguss	Grey cast iron	1.2344	950–1100	X40CrMoV5-1	260–350
			0.6025	400–900	EN-GJI-250	200–280
			0.6678	500–800	EN-GJLA-XNiCr35-2	220–280
			0.7060	400–1000	EN-GJS-600-3	220–260
Sphäroguss	Nodular cast iron	0.7070		EN-GJS-700-2U	220–260	
		0.8155	500–1000	EN-GJMB-550-4	140–240	
Temperguss	Malleable cast iron					
H	Gehärteter Stahl	Hardened steel	Werkzeugstähle und Sphärogusslegierungen, Kaltarbeitsstähle und PM-Stähle Tool steel and nodular cast iron alloys, cold working steel and powder metallurgical steel	45–52 HRC		230–280
				53–56 HRC		200–250
				57–62 HRC		150–200
				63–65 HRC		100–150

Bei der langen Ausführung empfehlen wir die Vorschübe (f_z) um 30 % zu reduzieren.
 When using the long version we recommend reducing the feed (f_z) by 30 %.

Die angegebenen Schnittwerte sind Startwerte und müssen auf die individuellen Einsatzbedingungen abgestimmt werden.
 The cutting data specified are just for the first try. They need to be adjusted to the individual conditions within the production.

Anwendungsbeispiel Application example



Gesenk- und Formenbau: Schichten Umformtechnik Mold & Die: Finishing punching

Werkzeug Tool:

HSCline SuperFinish2, lang long (Ident No. 7172243)
 Kat.-Nr. Cat.-No. 1854C, d₁ = 12 mm, z = 2

Schneidstoff Cutting material: LCHK20M

Werkstoff Material: 1.2343, ca. 50–52 HRC

Schnittwerte Cutting data:

v_c = 250 m/min v_f = 1195 mm/min
 n = 6635 min⁻¹ a_e = 0,1 mm
 f_z = 0,09 mm a_p = 0,05 mm

	Fräserdurchmesser Cutting diameter (mm)					Schlichten Finishing a_e (mm)
	Schlichten Finishing a_p (mm) 0,05–0,12		Schlichten Finishing a_p (mm) 0,08–0,2			
	Vorschub pro Zahn Feed per tooth f_z (mm/z.)					
	Ø 4	Ø 6	Ø 8	Ø 10	Ø 12	
	0,05	0,07–0,1	0,1	0,12–0,15	0,12–0,18	d x 0,018–0,02
	0,06	0,09–0,12	0,12	0,12–0,15	0,12–0,18	
	0,04	0,06–0,08	0,08	0,12–0,15	0,12–0,18	
	0,06	0,08–0,1	0,12	0,12–0,15	0,12–0,18	
	0,05	0,08–0,1	0,1	0,12–0,15	0,12–0,18	
	0,06	0,09	0,12	0,14	0,17	
	0,04	0,06	0,08	0,1	0,12	
	0,03	0,05	0,07	0,08	0,1	
	0,05	0,07	0,1	0,12	0,14	
	0,06	0,09–0,12	0,12	0,12–0,15	0,12–0,18	
	0,06	0,09–0,12	0,12	0,12–0,15	0,12–0,18	
	0,06	0,09–0,12	0,12	0,12–0,15	0,12–0,18	
	0,06	0,09–0,12	0,12	0,12–0,15	0,12–0,18	
	0,06	0,09–0,12	0,12	0,12–0,15	0,12–0,18	
	0,05	0,07–0,1	0,1	0,12–0,15	0,12–0,18	d x 0,018–0,02
	0,06	0,08–0,1	0,12	0,12–0,15	0,12–0,18	
	0,06	0,08–0,1	0,12	0,12–0,15	0,12–0,18	
	0,06	0,08–0,1	0,12	0,12–0,15	0,12–0,18	
	0,05	0,07–0,1	0,1	0,12–0,15	0,12–0,18	d x 0,018–0,02
	0,03	0,04	0,06	0,07	0,09	
	0,02	0,04	0,05	0,06	0,07	
	0,02	0,03	0,04	0,05	0,06	

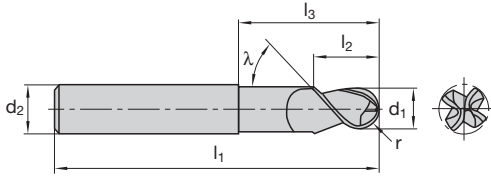

Katalog-Nr. Cat.-No.							1451C		
P								<input type="checkbox"/>	
M									
K								<input type="checkbox"/>	
N									
S									
H								<input checked="" type="checkbox"/>	
O									
d ₁	l ₂	l ₁	l ₃	d ₂	z	r	Ident No.	LMT-Code	
kurz short									
1	1	38	2,2	3	2	0,5	9207645	EM-HSCH 1x1/2.2 2BA	
2	2	50	3,6	6	2	1	9207653	EM-HSCH 2x2/3.6 2BA	
3	3	50	5,5	6	2	1,5	9207655	EM-HSCH 3x3/5.5 2BA	
4	4	57	14,5	6	2	2	9207863	EM-HSCH 4x4/14.5 2BA	
5	5	57	21	6	2	2,5	9207865	EM-HSCH 5x5/21 2BA	
6	6	57	21	6	2	3	9207867	EM-HSCH 6x6/21 2BA	
8	8	63	27	8	2	4	9207870	EM-HSCH 8x8/27 2BA	
10	10	72	32	10	2	5	9207904	EM-HSCH 10x10/32 2BA	
12	12	83	38	12	2	6	9207905	EM-HSCH 12x12/38 2BA	
4	4	57	14,5	6	4	2	9207862	EM-HSCH 4x4/14.5 4BA	
5	5	57	21	6	4	2,5	9207864	EM-HSCH 5x5/21 4BA	
6	6	57	21	6	4	3	9207866	EM-HSCH 6x6/21 4BA	
8	8	63	27	8	4	4	9207869	EM-HSCH 8x8/27 4BA	
10	10	72	32	10	4	5	9207871	EM-HSCH 10x10/32 4BA	
lang long									
4	4	80	19	6	2	2	9207907	EM-HSCH 4x4/19 2BA	
5	5	80	44	6	2	2,5	9207909	EM-HSCH 5x5/44 2BA	
6	6	80	44	6	2	3	9207923	EM-HSCH 6x6/44 2BA	
8	8	90	54	8	2	4	9207926	EM-HSCH 8x8/54 2BA	
10	10	100	60	10	2	5	9207930	EM-HSCH 10x10/60 2BA	
12	12	110	65	12	2	6	9207931	EM-HSCH 12x12/65 2BA	
4	4	80	19	6	4	2	9207906	EM-HSCH 4x4/19 4BA	
5	5	80	44	6	4	2,5	9207908	EM-HSCH 5x5/44 4BA	
6	6	80	44	6	4	3	9207910	EM-HSCH 6x6/44 4BA	
8	8	90	54	8	4	4	9207925	EM-HSCH 8x8/54 4BA	
10	10	100	60	10	4	5	9207927	EM-HSCH 10x10/60 4BA	

Schnittwertempfehlungen ab Seite 100
 Cutting data recommendations starting page 100

■ = Hauptanwendung First choice
 □ = Nebenanwendung Second choice

Gültigkeit der Diagramme

für $a_p \geq 0,5 \cdot d_1$ bzw.
 $a_p \geq 0,5 \cdot d_4$ sonst

Berechnungsformeln siehe unten

Diagrams are valid

for $a_p \geq 0,5 \cdot d_1$ respectively
 $a_p \geq 0,5 \cdot d_4$ otherwise

see formula below

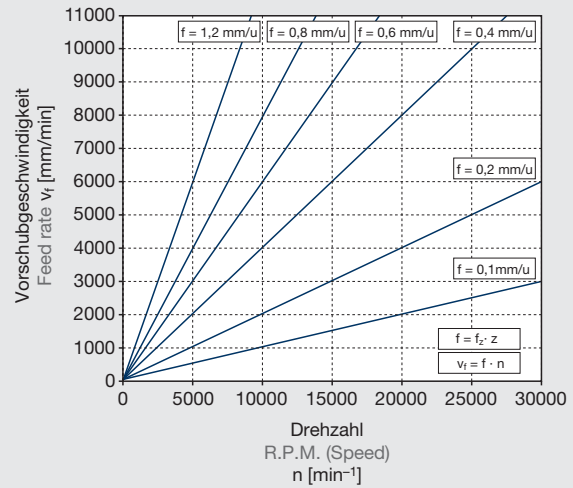
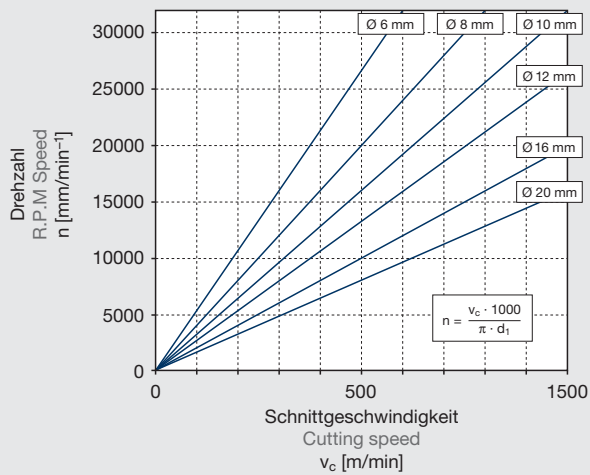

Kugelpkopierfräser
Ball nose copying milling cutter

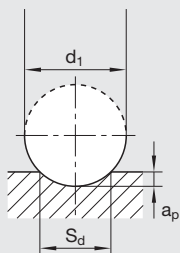

Kugelpkopierfräser mit einer
 Schnitttiefe von
 Ball nose copying milling cutter
 with depth of cut
 $a_p < 0,5 \cdot d_1$

$$n = \frac{v_c \cdot 1000}{2 \cdot \pi \cdot \sqrt{d_1 \cdot a_p - a_p^2}} \quad [\text{min}^{-1}]$$

a_p = Schnitttiefe
 Depth of cut [mm]

S_d = Schnittkreis-Ø, effektiver Ø
 Cutting circle dia., effective Ø [mm]

d_1 = Fräser-Ø
 Milling Cutter dia. [mm]

$$S_d = 2 \cdot \sqrt{d_1 \cdot a_p - a_p^2}$$

Fräser mit Eckenradius
Milling cutter with corner radius

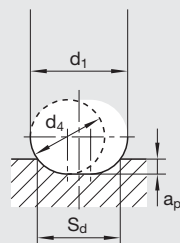

Fräser mit einer Schnitttiefe von
 Cutter with depth of cut
 $a_p < 0,5 \cdot d_4$

$$n = \frac{v_c \cdot 1000}{(d_1 - d_4 + 2 \cdot \sqrt{d_4 \cdot a_p - a_p^2}) \cdot \pi} \quad [\text{min}^{-1}]$$

$d_4 = 2 \cdot \text{Eckenradius}$
 $2 \cdot \text{Corner radius}$ [mm]

$$S_d = d_1 - d_4 + 2 \cdot \sqrt{d_4 \cdot a_p - a_p^2}$$

z = Zähnezahl
 No. of teeth

f_z = Vorschub/Zahn
 Feed/Tooth [mm]

f = Vorschub/Umdrehung
 Feed/Revolution [mm/u]

HSCLine Schafffräser mit Kugelstirn (1451C)

Schnittwertempfehlungen für Schafffräser Typ H, gerade und runde Stirn

HSCLine end mill with ball nose (1451C)

Cutting data recommendations for end mills type H, straight corner or ball nose

	Werkstoff	Material	Werkstoff-Nr. Material No.	DIN Bezeichnung Alt DIN Description Old	Härte Hardness	DIN Bezeichnung Neu DIN Description New
P	Vergütbare Formenstähle	Heat-treatable die steels	1.2311	40CrMnMo7	280–325 HB	40CrMnMo7
			1.2312	40CrMnMoS8.6	280–325 HB	40CrMnMoS8-6
			1.2738	40CrMnNiMoS8.6.4	280–325 HB	40CrMnNiMoS8-6-4
			1.2711	54NiCrMoV6	280–415 HB	54NiCrMoV6
	Durchhärtende Werkzeugstähle	Full hardening tools steels	1.2343	X38CrMoV5 1	230 HB	X37CrMoV5 1
			1.2080	X210Cr12	250 HB	X210Cr12
			1.2379	X155CrVMo12 1	250 HB	X153CrVMo12 1
			1.2767	X45NiCrMo4	260 HB	X45NiCrMo4
	Nitrierstähle	Nitriding steels	1.8550	34CrAlNi7	240–300 HB	34CrAlNi7
			1.8519	31CrMoV9	265–310 HB	31CrMoV9
			1.7735	14CrMoV6.9	265–310 HB	14CrMoV6.9
			1.2344	X40CrMoV5.1	280–325 HB	X40CrMoV5-1
K	Grauguss	Grey cast iron	0.6025	GG25	100–400 (120–260 HB)	EN-GJI-250
	Legierter Grauguss	Alloyed grey cast iron	0.6678	GGL-NiCr35 2	150–250 (160–230 HB)	EN-GJLA-XNiCr35-2
	Sphäroguss	Nodular cast iron	0.7060	GGG60	400–800	EN-GJS-600-3
			0.7070	GGG70L	(120–310 HB)	EN-GJS-700-2U
Temperguss	Malleable cast iron	0.8155	GTS55	350–700 (150–280 HB)	EN-GJMB-550-4	
H	Gehärteter Stahl	Hardened steel			45–52 HRC	
					53–56 HRC	
					57–62 HRC	
					63–68 HRC	

Die angegebenen Schnittwerte sind Startwerte und müssen auf die vorhandenen Bedingungen abgestimmt werden.

Bei der langen Ausführung empfehlen wir die f_z -Werte um 30% zu reduzieren.

Hinweise zur Ermittlung des effektiven Schneidendurchmessers bei Kugelfräsern auf Seite 99.

The cutting data specified represents base values and must be adapted to the existing conditions.

For high values of total feed we recommend reducing the specified unit values of feed (f_z) by 30%.

Hints for calculation of the effective cutting diameter of ball nose end mills see page 99.

	Schnitt- geschwindigkeit Cutting speed v_c (m/min)	Fräserdurchmesser Cutting diameter (mm)								
		Vorschub pro Zahn Feed per tooth f_z (mm/z.)								
		1	2	3	4	5	6	8	10	12
	280-400	0,012	0,024	0,036	0,05	0,06	0,07	0,10	0,12	0,14
	280-400	0,014	0,03	0,043	0,06	0,07	0,09	0,12	0,14	0,17
	260-350	0,01	0,02	0,03	0,04	0,05	0,06	0,08	0,10	0,12
	260-350	0,014	0,03	0,043	0,06	0,07	0,09	0,12	0,14	0,17
	250-300	0,014	0,03	0,043	0,06	0,07	0,09	0,12	0,14	0,17
	220-280	0,01	0,02	0,03	0,04	0,05	0,06	0,08	0,10	0,12
	200-250	0,008	0,017	0,025	0,03	0,04	0,05	0,07	0,08	0,10
	250-300	0,01	0,024	0,036	0,05	0,06	0,07	0,10	0,12	0,14
	220-280	0,01	0,02	0,03	0,04	0,05	0,06	0,08	0,10	0,12
	240-320	0,01	0,02	0,03	0,04	0,05	0,06	0,08	0,10	0,12
	260-350	0,01	0,02	0,03	0,04	0,05	0,06	0,08	0,10	0,12
	260-350	0,014	0,03	0,043	0,06	0,07	0,09	0,12	0,14	0,17
	200-300	0,012	0,02	0,03	0,045	0,06	0,07	0,10	0,125	0,15
	180-280	0,01	0,018	0,025	0,04	0,055	0,065	0,09	0,115	0,13
	160-260	0,01	0,018	0,025	0,04	0,055	0,065	0,09	0,115	0,13
	140-240	0,01	0,018	0,025	0,04	0,055	0,065	0,09	0,115	0,13
	200-250	0,01	0,02	0,03	0,04	0,05	0,06	0,08	0,10	0,12
	180-220	0,007	0,014	0,02	0,03	0,04	0,04	0,06	0,07	0,09
	150-200	0,006	0,012	0,02	0,02	0,03	0,04	0,05	0,06	0,07
	100-150	0,005	0,01	0,01	0,02	0,02	0,03	0,04	0,05	0,06

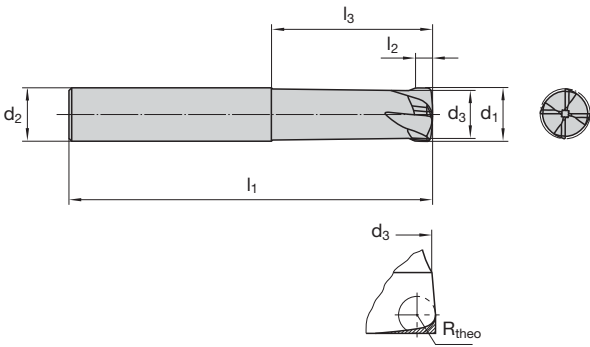

Katalog-Nr. Cat.-No.										1431C	
P										■	
M										■	
K										□	
N										■	
S										■	
H										■	
O										■	
d ₁	d ₃	l ₂	l ₁	l ₃	d ₂	z	R _{theo}	a _{p max}	Ident No.	LMT-Code	
extra kurz extra short											
3	2,7	1	50	6	6	4	0,3	0,15	7048450	EM-4F 3x1/6 4FA	
4	3,55	1,5	57	8	6	4	0,4	0,2	9207993	EM-4F 4x1.5/8 4FA	
5	4,4	2	57	10	6	4	0,5	0,25	9207994	EM-4F 5x2/10 4FA	
6	5,3	2,5	57	12	6	4	0,6	0,3	9207995	EM-4F 6x2.5/12 4FA	
8	7,1	3	63	16	8	4	0,8	0,4	9207996	EM-4F 8x3/16 4FA	
10	8,9	3,5	72	20	10	4	1	0,5	9207997	EM-4F 10x3.5/20 4FA	
12	10,7	4	83	24	12	4	1,2	0,6	9207998	EM-4F 12x4/24 4FA	
kurz short											
3	2,7	1	57	12	6	4	0,3	0,15	7048451	EM-4F 3x1/12 4FA	
4	3,55	1,5	57	15	6	4	0,4	0,2	9207999	EM-4F 4x1.5/15 4FA	
5	4,4	2	57	17,5	6	4	0,5	0,25	9208000	EM-4F 5x2/17.5 4FA	
6	5,3	2,5	57	19	6	4	0,6	0,3	9208002	EM-4F 6x2.5/19 4FA	
8	7,1	3	63	24	8	4	0,8	0,4	9208003	EM-4F 8x3/24 4FA	
10	8,9	3,5	72	28,5	10	4	1	0,5	9208004	EM-4F 10x3.5/28.5 4FA	
12	10,7	4	83	34	12	4	1,2	0,6	9208005	EM-4F 12x4/34 4FA	
lang long											
3	2,7	1	70	18	6	4	0,3	0,15	7019116	EM-4F 3x1/18 4FA	
4	3,55	1,5	70	24	6	4	0,4	0,2	7048452	EM-4F 4x1.5/24 4FA	
5	4,4	2	70	30	6	4	0,5	0,25	7048453	EM-4F 5x2/30 4FA	
6	5,3	2,5	80	35	6	4	0,6	0,3	9208006	EM-4F 6x2.5/35 4FA	
8	7,1	3	80	40	8	4	0,8	0,4	9208007	EM-4F 8x3/40 4FA	
10	8,9	3,5	90	45	10	4	1	0,5	9208008	EM-4F 10x3.5/45 4FA	
12	10,7	4	100	50	12	4	1,2	0,6	9208009	EM-4F 12x4/50 4FA	

Schnittwertempfehlungen ab Seite 104
 Cutting data recommendations starting page 104

■ = Hauptanwendung First choice
 □ = Nebenanwendung Second choice

Hart gegen gehärtete Werkstoffe.

Nanosphere Red Schafffräser sind geschaffen für die Bearbeitung gehärteter Werkstoffe und hochfester Werkzeugstähle zwischen 54 und 68 HRC.

Bei diesen Prozessen entwickeln sich sehr hohe Temperaturen. Nanosphere Red erhöht die Einsatztemperatur um 200 °C gegenüber bisherigen Beschichtungen.

Dabei nutzt Nanosphere Red die Vorteile des nanostrukturierten Schichtaufbaus aus – extrem hart bei einer hohen Zähigkeit. Damit hat Rissausbreitung keine Chance.

Merkmale:

- Schafffräser für Gesenk- und Formenbau
- Für Werkstoffe zwischen 54 und 68 HRC
- 3 µm dicke Nanolayer PVD-Schicht
- Nanostrukturierter Aufbau
- Einsatztemperatur bis 1100 °C

Vorteile:

- Hochtemperaturbeständig
- Extrem verschleißfest
- Doppelte Standzeit
- Ermöglicht höhere Bearbeitungsgeschwindigkeiten
- Wiederbeschichtbar
- Weltweiter Service

Hard tools for hardened materials

Nanosphere Red end mills have been specially made for machining hardened materials and high-tensile tooling steels between 54 and 68 HRC.

Extremely high temperatures arise during these processes. Nanosphere Red increases the working temperature by 200 °C with respect to coatings previously available.

At the same time Nanosphere Red makes the most of the advantages of the nano-based structure of the coating – extremely hard with a high toughness. Hence there is no chance of cracks being formed.

Features:

- End mills for mould and die
- For materials between 54 und 68 HRC
- 3 µm thick nanolayer PVD coating
- Coating with nano structure
- Working temperatures of up to 1100 °C

Advantages:

- Resistant to high temperatures
- Highly wear-proof
- Doubled useful life
- Enables higher machining speeds
- Can be recoated
- Worldwide service

REM-Aufnahme des nanostrukturierten Aufbaus von Nanosphere Red
 SEM (scanning electron microscope) image of the nano-based structure

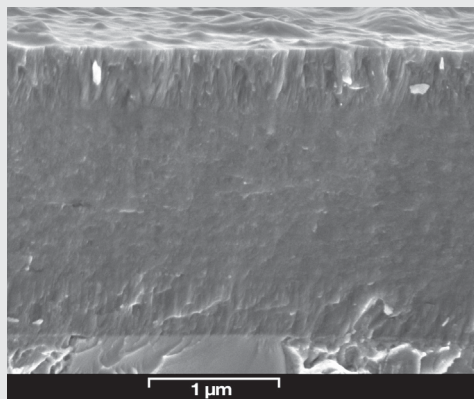

Vorteile:

- Sehr gute Oxidationsbeständigkeit (> 1100)
- Keine plastische Verformung der Nanokristalle
- Kein Korngrenzgleiten
- Hohe Härte (> 4000 HV)
- Extreme Hochtemperaturfestigkeit
- Keine Rissausbreitung
- Quasi-isotropes Werkstoffverhalten

Advantages:

- Very high resistance to oxidation
- No plastic deformation of the nano-crystallite
- No grain boundary slip
- High values of hardness (> 4000 HV)
- Extreme toughness
- No spread of cracks
- Quasi-isotrope material behavior

Schematischer Aufbau der nanostrukturierten Schicht
 Schematic view of the nano-based coating

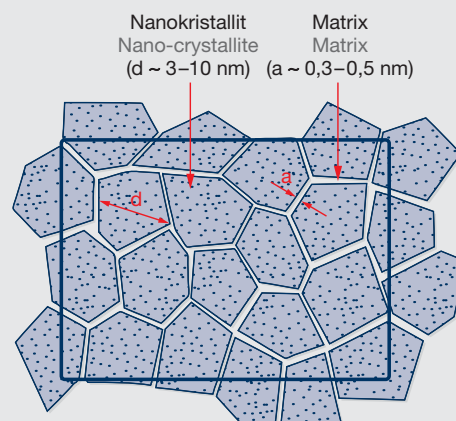

MultiEdge 4Feed HSC
Schnittwertempfehlungen
Cutting data recommendations

	Werkstoff	Material	Werkstoff-Nr. Material No.	DIN Bezeichnung Alt DIN Description Old	R_m/UTS (N/mm²)	DIN Bezeichnung Neu DIN Description New
P	Vergütbare Formenstähle	Heat-treatable die steels	1.2311	40CrMnMo7	-1100	40CrMnMo7
			1.2312	40CrMnMoS8.6		40CrMnMoS8-6
			1.2738	40CrMnNiMoS8.6.4		40CrMnNiMoS8-6-4
			1.2711	54NiCrMoV6		54NiCrMoV6
	Durchhärtende Werkzeugstähle	Full hardening tools steels	1.2343	X38CrMoV5 1	350-1400	X37CrMoV5 1
			1.2080	X210Cr12		X210Cr12
			1.2379	X155CrVMo12 1		X153CrVMo12 1
			1.2767	X45NiCrMo4		X45NiCrMo4
	Nitrierstähle	Nitriding steels	1.8550	34CrAlNi7	950-1400	34CrAlNi7
			1.8519	31CrMoV9		31CrMoV9
			1.7735	14CrMoV6.9		14CrMoV6.9
			1.2344	X40CrMoV5.1		X40CrMoV5-1
K	Grauguss	Grey cast iron	0.6025	GG25	100-400 (120-260 HB)	EN-GJl-250
	Legierter Grauguss	Alloyed grey cast iron	0.6678	GGL-NiCr35 2	150-250 (160-230 HB)	EN-GJLA-XNiCr35-2
	Sphäroguss	Nodular cast iron	0.7060 0.7070	GGG60 GGG70L	400-800 (120-310 HB)	EN-GJS-600-3 EN-GJS-700-2U
	Temperguss	Malleable cast iron	0.8155	GTS55	350-700 (150-280 HB)	EN-GJMB-550-4
H	Gehärteter Stahl	Hardened steel			45-52 HRC	
					53-56 HRC	
					57-62 HRC	
					63-68 HRC	

Die angegebenen Schnittwerte sind Startwerte bezogen auf Ø 10 mm und müssen auf die vorhandenen Bedingungen abgestimmt werden.
 Bei der langen Ausführung empfehlen wir die f_z -Werte um 30% zu reduzieren.



Gesenk und Formenbau – Schruppbearbeitung (trocken)
Mould and die – roughing (dry)

Werkzeug Tool:
 MultiEdge 4Feed HSC
 1431C | $d_1 = 10 \text{ mm}$, $z = 4$
 Nanosphere Red LC620ZM

Werkstoff Material:
 1.2379 (HRC 57-58)

Schnittwerte Cutting data:
 $v_c = 120 \text{ m/min}$
 $n = 3800 \text{ min}^{-1}$
 $v_f = 4400 \text{ mm/min}$
 $f_z = 0,29 \text{ mm}$
 $a_e = 3 \text{ mm}$
 $a_p = 0,25 \text{ mm}$

Standzeit Tool life:
50 % höhere Standzeit 50 % higher tool life

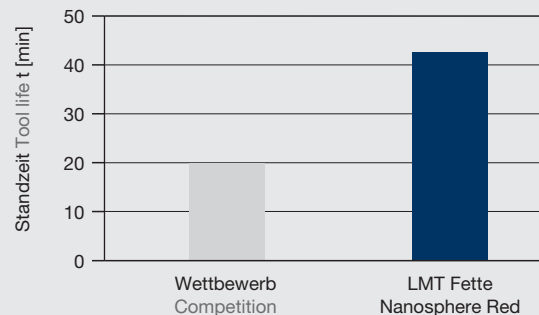

	Schnitt- geschwindigkeit Cutting speed v_c (m/min)	Fräserdurchmesser Cutting diameter (mm)						Schnitttiefe Cutting depth a_p (mm)
		Vorschub pro Zahn Feed per tooth f_z (mm/z.)						
		4	5	6	8	10	12	
	240	0,30	0,38	0,45	0,60	0,75	0,90	0,05 x d_1 (= $a_{p \max}$)
	220	0,30	0,38	0,45	0,60	0,75	0,90	
	200	0,24	0,30	0,36	0,48	0,60	0,70	0,04 x d_1
	200	0,28	0,35	0,42	0,56	0,70	0,85	
	180	0,26	0,33	0,39	0,52	0,65	0,80	0,04 x d_1
	160	0,24	0,30	0,36	0,48	0,60	0,70	
	200	0,28	0,35	0,42	0,56	0,70	0,85	0,04 x d_1
	180	0,26	0,33	0,39	0,52	0,65	0,80	
	160	0,24	0,30	0,36	0,48	0,60	0,70	0,05 x d_1
	200	0,35	0,40	0,55	0,65	0,80	0,95	
	180	0,30	0,35	0,50	0,60	0,75	0,90	
	180	0,30	0,35	0,50	0,60	0,75	0,90	
	160	0,30	0,35	0,50	0,60	0,75	0,90	0,04 x d_1
	160-180	0,16	0,20	0,24	0,32	0,40	0,48	
	120-160	0,12	0,15	0,18	0,24	0,30	0,36	
	100-120	0,08	0,10	0,12	0,16	0,20	0,24	
	80-100	0,06	0,08	0,09	0,12	0,15	0,18	0,01 x d_1

The cutting data indicated are starting values based on \varnothing 10 mm and must be adjusted to the prevailing conditions.
We recommended to reduce the f_z -value with the long version by 30%.

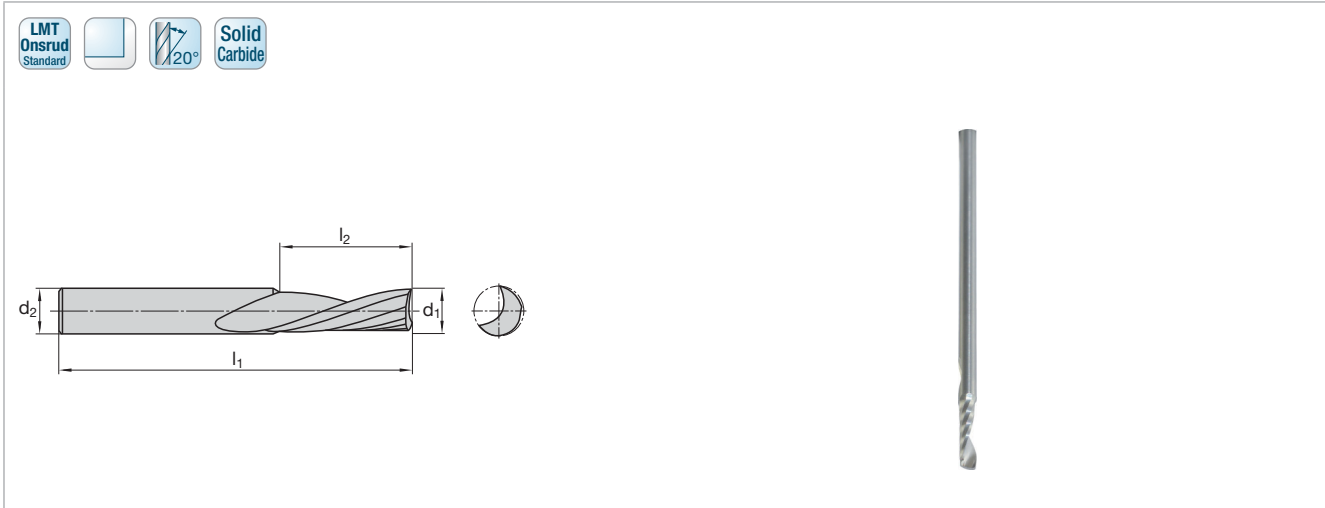

Katalog-Nr. Cat.-No.					63-850		
P							
M							
K							
N							
S							
H							
O						■	
d ₁	l ₂	l ₁	d ₂	z	Ident No.	LMT-Code	
2	8	64	6	1	2349956	63-854	
3	8	50	3	1	2349959	63-860	
3	8	64	6	1	2349960	63-862	
3	12	64	3	1	2349961	63-864	
3	12	64	6	1	2349962	63-866	
4	12	64	4	1	2349964	63-870	
4	20	64	6	1	2349966	63-874	
5	16	64	5	1	2349968	63-878	
5	16	64	6	1	2349969	63-880	
6	12	64	6	1	2349972	63-886	
6	20	64	6	1	2349973	63-888	
6	38	76	6	1	2349975	63-892	
8	25	64	8	1	2349976	63-894	
8	38	76	8	1	7100378	63-896	
10	30	76	10	1	7095442	63-898	

■ = Hauptanwendung First choice
□ = Nebenanwendung Second choice

Schnittwertempfehlungen Cutting data recommendations

	Werkstoff Material	Werkstoff-Nr. Material No.	DIN Bezeichnung Alt DIN Description Old	R _m /UTS (N/mm ²)	DIN Bezeichnung Neu DIN Description New	Schnitt- geschwindigkeit Cutting speed v _c (m/min)	Fräserdurchmesser Cutting diameter (mm)		
							Vorschub pro Zahn Feed per tooth f _z (mm/z.)		
							2-4	5-6	8-10
O	Weicher Kunststoff Soft Plastic		Thermoplaste: PVC, PE, PP, ...	40-70	Thermoplaste: PVC, PE, PP, ...	450-700	0,12	0,14	0,20
	Harter Kunststoff Hard Plastic		Duroplaste: Bakelit, Melamin, MF, MPF	20-40	Duroplaste: Bakelit, Melamin, MF, MPF	450-700	0,12	0,14	0,20

1-schneidiger Router mit O-Form Nut 1 Flute solid carbide spiral super O

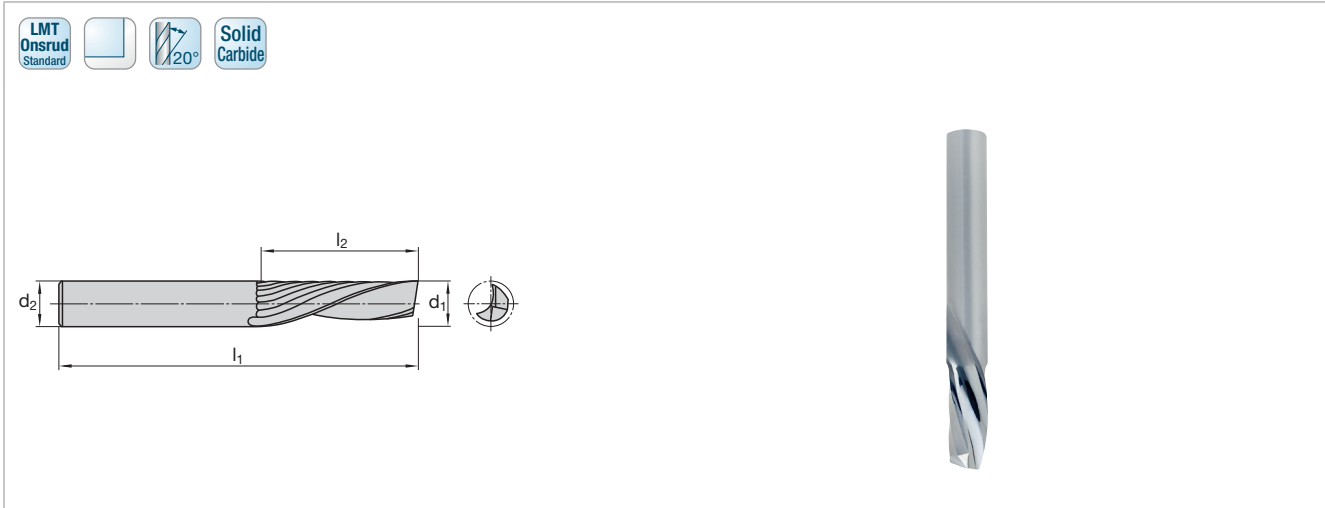

Katalog-Nr. Cat.-No.		64-000 65-000					
P							
M							
K							
N							
S							
H							
O			■				
d ₁	l ₂	l ₁	d ₂	z	Spirale Helix	Ident No.	LMT-Code
3	12	50	6	1	links left	9125264	64-012M
6	32	76	6	1	links left	9125350	64-026M
2	6	50	3	1	rechts right	9125266	65-000M
5	16	64	6	1	rechts right	9125267	65-018M
6	16	64	6	1	rechts right	7068618	65-023M
10	29	76	10	1	rechts right	9125269	65-033M

■ = Hauptanwendung First choice
□ = Nebenanwendung Second choice

Schnittwertempfehlungen Cutting data recommendations

	Werkstoff Material	Werkstoff-Nr. Material No.	DIN Bezeichnung Alt DIN Description Old	R _m /UTS (N/mm ²)	DIN Bezeichnung Neu DIN Description New	Schnitt- geschwindigkeit Cutting speed v _c (m/min)	Fräserdurchmesser Cutting diameter (mm)		
							Vorschub pro Zahn Feed per tooth f _z (mm/z.)		
							2-3	4-6	8-10
O	Weicher Kunststoff Soft Plastic		Thermoplaste: PVC, PE, PP, ...	40-70	Thermoplaste: PVC, PE, PP, ...	115-575	0,10	0,20	0,30
	Harter Kunststoff Hard Plastic		Duroplaste: Bakelit, Melamin, MF, MPF	20-40	Duroplaste: Bakelit, Melamin, MF, MPF	115-575	0,10	0,20	0,30

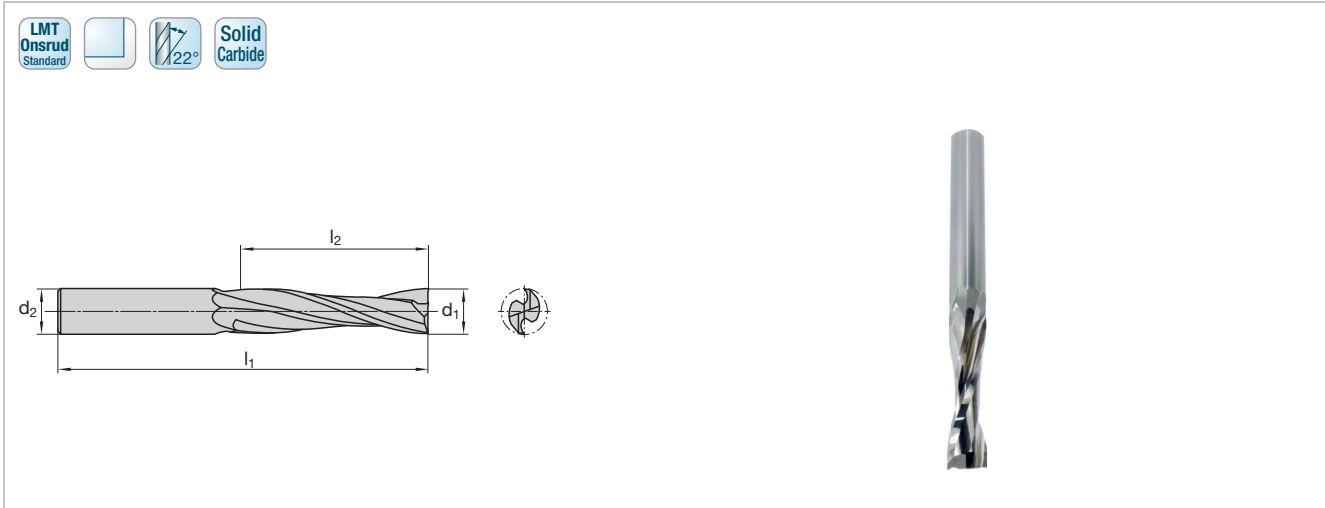

Katalog-Nr. Cat.-No.					52-700		
P							
M							
K							
N							
S							
H							
O						■	
d ₁	l ₂	l ₁	d ₂	z	Ident No.	LMT-Code	
12	35	100	12	2	7053925	52-742	
12	45	100	12	2	6601084	52-744	
12	55	100	12	2	6601085	52-746	
16	45	120	16	2	6601086	52-752	
16	55	120	16	2	7053929	52-754	
20	65	125	20	2	6601088	52-764	

■ = Hauptanwendung First choice
□ = Nebenanwendung Second choice

Schnittwertempfehlungen Cutting data recommendations

	Werkstoff Material	Werkstoff-Nr. Material No.	DIN Bezeichnung Alt DIN Description Old	R _m /UTS (N/mm ²)	DIN Bezeichnung Neu DIN Description New	Schnitt- geschwindigkeit Cutting speed v _c (m/min)	Fräserdurchmesser Cutting diameter (mm)		
							Vorschub pro Zahn Feed per tooth f _z (mm/z.)		
							12	16	20
O	Weicher Kunststoff Soft Plastic		Thermoplaste: PVC, PE, PP, ...	40-70	Thermoplaste: PVC, PE, PP, ...	675-1150	0,34	0,39	0,42

3-schneidiger Router zum Schlichten 3 Flute low helix finisher

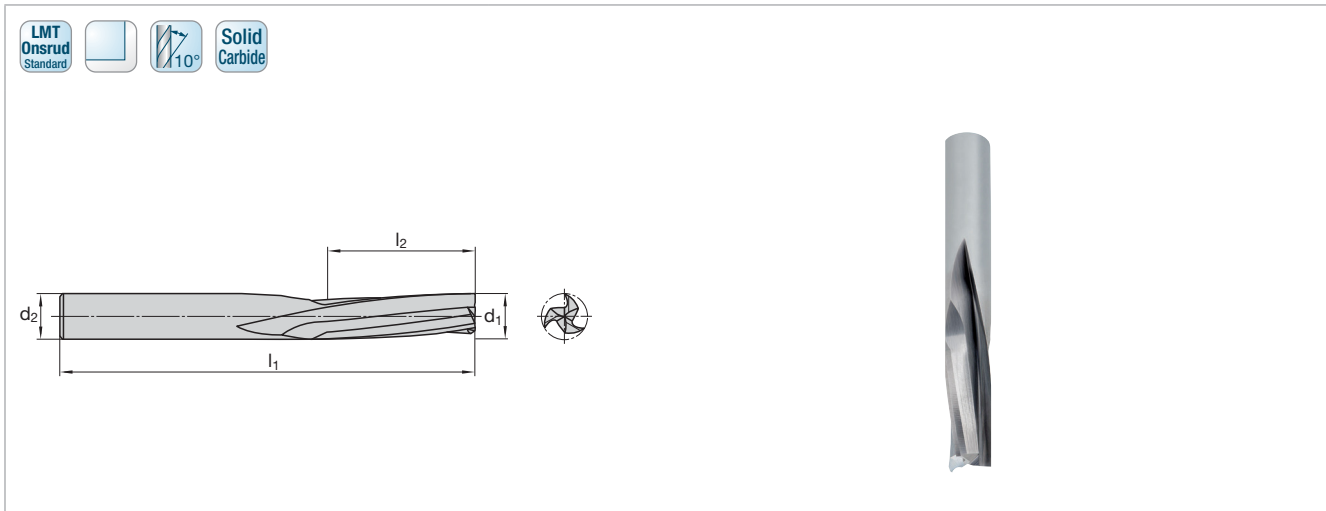

Katalog-Nr. Cat.-No.					60-200	
P						
M						
K						
N						
S						
H						
O						■
d ₁	l ₂	l ₁	d ₂	z	Ident No.	LMT-Code
8	25	76	8	3	2349864	60-471
10	35	76	10	3	2349865	60-473
12	35	88	12	3	2349866	60-475

■ = Hauptanwendung First choice
□ = Nebenanwendung Second choice

Schnittwertempfehlungen Cutting data recommendations

	Werkstoff Material	Werkstoff-Nr. Material No.	DIN Bezeichnung Alt DIN Description Old	R _m /UTS (N/mm ²)	DIN Bezeichnung Neu DIN Description New	Schnitt- geschwindigkeit Cutting speed v _c (m/min)	Fräserdurchmesser Cutting diameter (mm)		
							Vorschub pro Zahn Feed per tooth f _z (mm/z.)		
							8	10	12
O	Weicher Kunststoff Soft Plastic		Thermoplaste: PVC, PE, PP, ...	40-70	Thermoplaste: PVC, PE, PP, ...	450-700	0,12	0,14	0,20
	Harter Kunststoff Hard Plastic		Duroplaste: Bakelit, Melamin, MF, MPF	20-40	Duroplaste: Bakelit, Melamin, MF, MPF	450-700	0,12	0,14	0,20

Katalog-Nr. Cat.-No.	54-200
P	
M	
K	
N	
S	
H	
O	■

d ₁	l ₂	l ₁	d ₂	z	Spirale Helix	Ident No.	LMT-Code
6	19	76	6	4	rechts right	7069569	54-260
8	22	76	8	4	rechts right	2608180	54-266
10	25	76	10	4	rechts right	7069571	54-270
12	25	76	12	4	rechts right	7100377	54-276
6	19	76	6	4	links left	2608178	54-261
8	22	76	8	4	links left	2608181	54-267
10	25	76	10	4	links left	2608182	54-271
12	25	76	12	4	links left	2608183	54-277

■ = Hauptanwendung First choice
□ = Nebenanwendung Second choice

Schnittwertempfehlungen Cutting data recommendations

	Werkstoff Material	Werkstoff-Nr. Material No.	DIN Bezeichnung Alt DIN Description Old	R _m /UTS (N/mm ²)	DIN Bezeichnung Neu DIN Description New	Schnitt- geschwindigkeit Cutting speed v _c (m/min)	Fräserdurchmesser Cutting diameter (mm)			
							Vorschub pro Zahn Feed per tooth f _z (mm/z.)			
							6	8	10	12
O	Faserverbundstoffe Composites		CFRP		CFRP	170-375	0,08	0,11	0,13	0,20
			GFRP		G10/Fiberglass					
			Phenol		Phenolic					

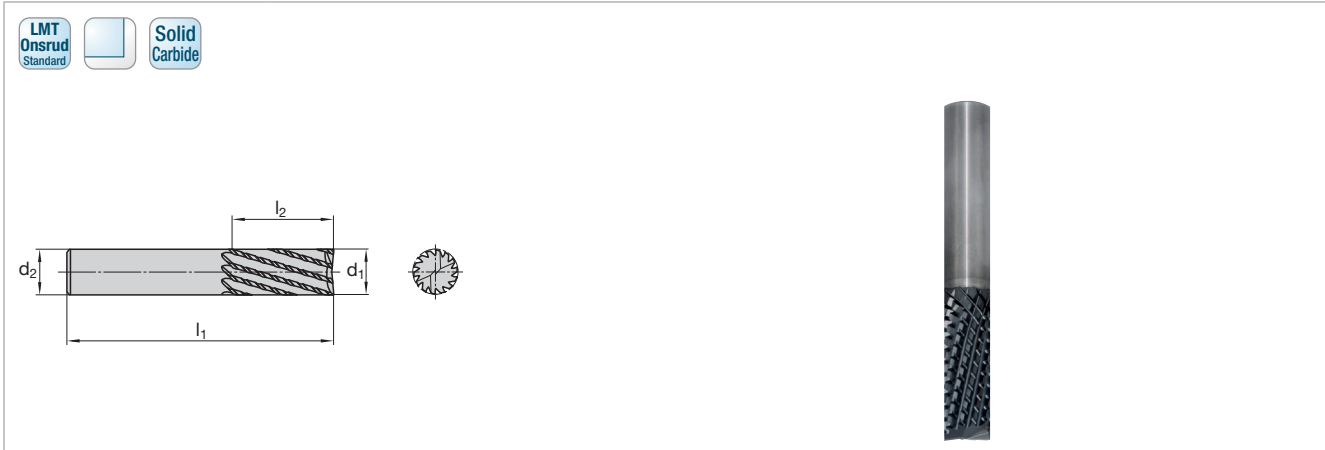

Katalog-Nr. Cat.-No.		66-500					
P							
M							
K							
N							
S							
H							
O							
d ₁	l ₂	l ₁	d ₂	z	Ausführung Point Style	Ident No.	LMT-Code
3	8	50	6	6	Fräser End mill	2643784	66-570
3	8	50	6	6	Bohrer Drill	2643785	66-572
4	11	50	6	6	Fräser End mill	2643786	66-574
4	11	50	6	6	Bohrer Drill	2643787	66-576
5	13	50	6	8	Fräser End mill	2643788	66-578
5	13	50	6	8	Bohrer Drill	2643789	66-580
6	13	50	6	10	Fräser End mill	2643790	66-582
6	13	50	6	10	Bohrer Drill	2643791	66-584
8	19	63	8	12	Fräser End mill	2643792	66-586
8	19	63	8	12	Bohrer Drill	2643793	66-588
10	22	72	10	12	Fräser End mill	2643794	66-590
10	22	72	10	12	Bohrer Drill	2643795	66-592
12	26	83	12	14	Fräser End mill	2643796	66-594
12	26	83	12	14	Bohrer Drill	2643797	66-596

■ = Hauptanwendung First choice □ = Nebenanwendung Second choice

Vorschub-Korrektur-Faktoren f ₁ Feed correction factor f ₁									
v _f = n · z · f _z · f ₁									
CFRP			GFRP G10/Fiberglass			Phenol Phenolic			
a _e	a _p		a _e	a _p		a _e	a _p		
	1x	1,25x		2x	1x		1,25x	2x	1x
1 x d ₁	1		1 x d ₁	1		1 x d ₁	1		
0,33 x d ₁	1,4	1,4	0,33 x d ₁	1,4	1,4	0,33 x d ₁	1,4	1,4	
0,15 x d ₁	2	2	0,15 x d ₁	2	2	0,15 x d ₁	2	2	2
0,05 x d ₁	2,5	2,5	0,05 x d ₁	2,5	2,5	0,05 x d ₁	2,5	2,5	2,5

a_e = Hauptanwendung Width of cut in mm
a_p = Nebenanwendung Depth of cut in mm
d₁ = Durchmesser in mm Cutter diameter in mm
f₁ = Korrekturfaktor für v_f Correction factor for v_f
f_z = Vorschub pro Zahn in mm Feed per tooth in mm
n = Drehzahl in min⁻¹ Speed in min⁻¹
v_f = Vorschubgeschwindigkeit in mm/min
Feed rate in mm/min
z = Anzahl der Schneiden No. of teeth

Schnittwertempfehlungen
Cutting data recommendations

	Werkstoff Material	Werkstoff-Nr. Material No.	DIN Bezeichnung Alt DIN Description Old	R _m /UTS (N/mm ²)	DIN Bezeichnung Neu DIN Description New	Schnitt- geschwindigkeit Cutting speed v _c (m/min)	Fräserdurchmesser Cutting diameter (mm)			
							Vorschub pro Zahn Feed per tooth f _z (mm/z.)			
							3-4	5-6	8-10	12
O	Faserverbundstoffe Composites		CFRP		CFRP	270-500	0,043	0,130	0,138	0,151
			GFRP		G10/Fiberglass	250-500	0,036	0,107	0,114	0,124
			Phenol		Phenolic	200-500	0,030	0,091	0,098	0,107

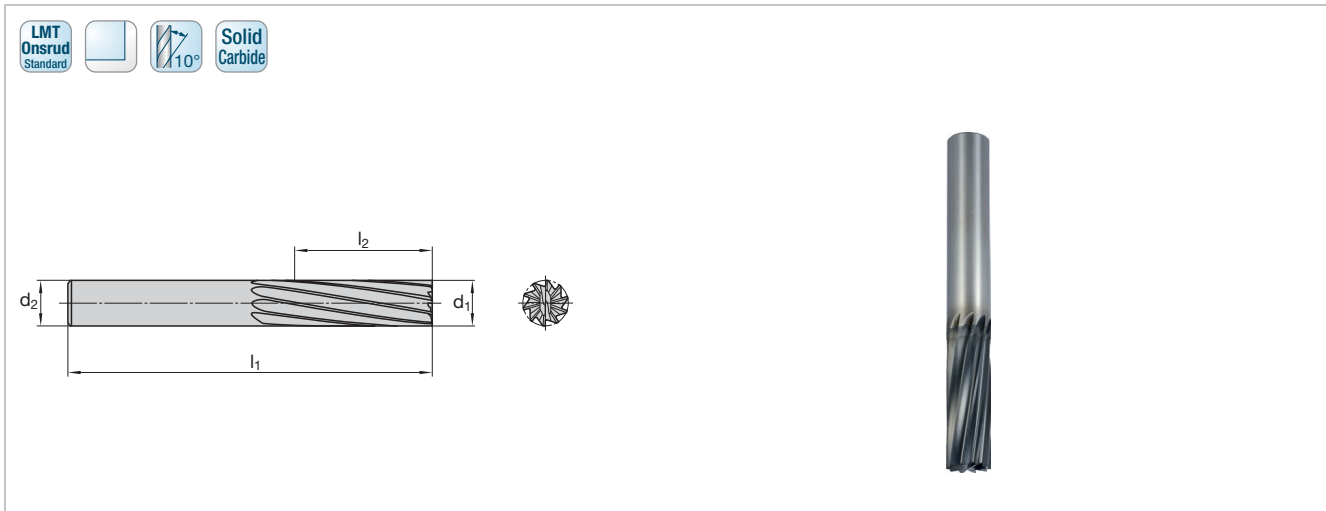

Katalog-Nr. Cat.-No.					66-700		
P							
M							
K							
N							
S							
H							
O						■	
d ₁	l ₂	l ₁	d ₂	z	Ident No.	LMT-Code	
6	20	90	6	6	2644511	66-720	
8	25	100	8	8	2605684	66-725	
10	30	100	10	8	2605685	66-730	
12	40	100	12	10	2605686	66-735	

■ = Hauptanwendung First choice
 □ = Nebenanwendung Second choice

Vorschub-Korrektur-Faktoren f ₁ Feed correction factor f ₁											
v _f = n · z · f _z · f ₁											
CFRP			GFRP G10/Fiberglass			Phenol Phenolic					
a _e	a _p			a _e	a _p			a _e	a _p		
	1x	1,25x	2x		1x	1,25x	2x		1x	1,25x	2x
0,15 x d ₁	1	1	1	0,15 x d ₁	1	1	1	0,15 x d ₁	1	1	1
0,05 x d ₁	1,2	1,2	1,2	0,05 x d ₁	1,2	1,2	1,2	0,05 x d ₁	1,2	1,2	1,2

a_e = Hauptanwendung Width of cut in mm
 a_p = Nebenanwendung Depth of cut in mm
 d₁ = Durchmesser in mm Cutter diameter in mm
 f₁ = Korrekturfaktor für v_f Correction factor for v_f
 f_z = Vorschub pro Zahn in mm Feed per tooth in mm
 n = Drehzahl in min⁻¹ Speed in min⁻¹
 v_f = Vorschubgeschwindigkeit in mm/min
 Feed rate in mm/min
 z = Anzahl der Schneiden No. of teeth

Schnittwertempfehlungen
Cutting data recommendations

	Werkstoff Material	Werkstoff-Nr. Material No.	DIN Bezeichnung Alt DIN Description Old	R _m /UTS (N/mm ²)	DIN Bezeichnung Neu DIN Description New	Schnitt- geschwindigkeit Cutting speed v _c (m/min)	Fräserdurchmesser Cutting diameter (mm)		
							Vorschub pro Zahn Feed per tooth f _z (mm/z.)		
							6	8-10	12
O	Faserverbundstoffe Composites		CFRP		CFRP	150-450	0,009	0,013	0,018
			GFRP		G10/Fiberglass				
			Phenol		Phenolic				

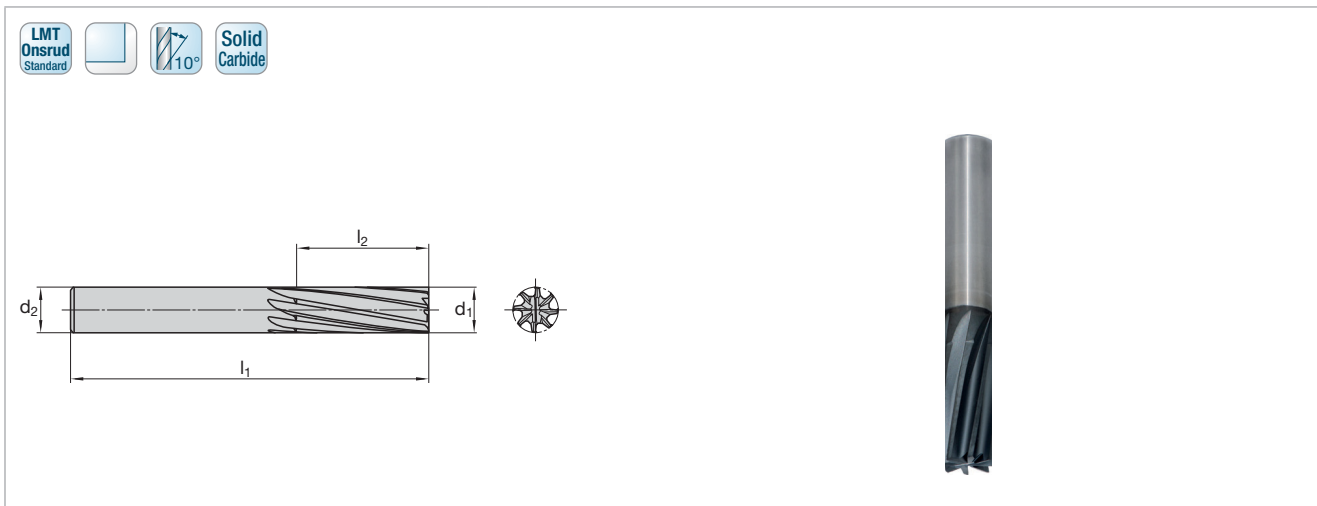

Katalog-Nr. Cat.-No.					66-750		
P							
M							
K							
N							
S							
H							
O						■	
d₁	l₂	l₁	d₂	z	Ident No.	LMT-Code	
6	20	90	6	4	2643740	66-766	
8	25	100	8	6	2643741	66-768	
10	30	100	10	6	2643742	66-770	
12	38	100	12	8	2643743	66-772	

■ = Hauptanwendung First choice
□ = Nebenanwendung Second choice

Vorschub-Korrektur-Faktoren f_1 Feed correction factor f_1											
$v_f = n \cdot z \cdot f_z \cdot f_1$											
CFRP			GFRP G10/Fiberglass			Phenol Phenolic					
a_e	a_p			a_e	a_p			a_e	a_p		
	1x	1,25x	2x		1x	1,25x	2x		1x	1,25x	2x
1 x d ₁	1			1 x d ₁	1			1 x d ₁	1		
0,33 x d ₁	1,4	1,4		0,33 x d ₁	1,4	1,4		0,33 x d ₁	1,4	1,4	
0,15 x d ₁	2	2	2	0,15 x d ₁	2	2	2	0,15 x d ₁	2	2	2
0,05 x d ₁	2,5	2,5	2,5	0,05 x d ₁	2,5	2,5	2,5	0,05 x d ₁	2,5	2,5	2,5

a_e = Hauptanwendung Width of cut in mm
 a_p = Nebenanwendung Depth of cut in mm
 d_1 = Durchmesser in mm Cutter diameter in mm
 f_1 = Korrekturfaktor für v_f Correction factor for v_f
 f_z = Vorschub pro Zahn in mm Feed per tooth in mm
 n = Drehzahl in min^{-1} Speed in min^{-1}
 v_f = Vorschubgeschwindigkeit in mm/min
 Feed rate in mm/min
 z = Anzahl der Schneiden No. of teeth

Schnittwertempfehlungen Cutting data recommendations

	Werkstoff Material	Werkstoff-Nr. Material No.	DIN Bezeichnung Alt DIN Description Old	R_m/UTS (N/mm ²)	DIN Bezeichnung Neu DIN Description New	Schnitt- geschwindigkeit Cutting speed v_c (m/min)	Fräserdurchmesser Cutting diameter (mm)		
							Vorschub pro Zahn Feed per tooth f_z (mm/z.)		
							6	8-10	12
O	Faserverbundstoffe Composites		CFRP		CFRP	150-450	0,004	0,007	0,009
			GFRP		G10/Fiberglass				
			Phenol		Phenolic				

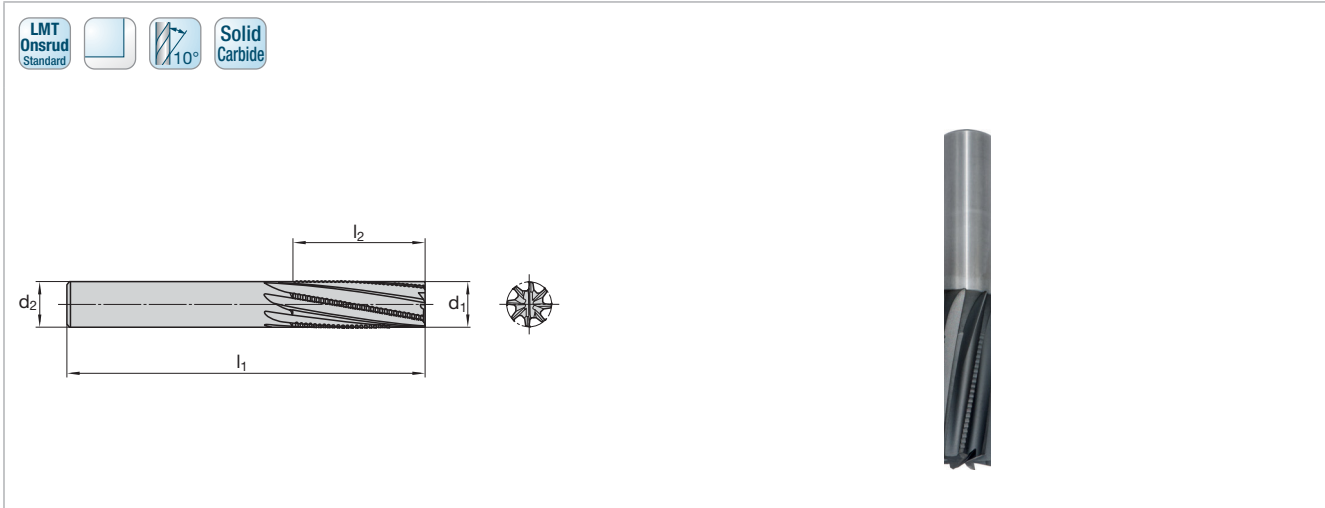

Katalog-Nr. Cat.-No.					66-775	
P						
M						
K						
N						
S						
H						
O						■
d ₁	l ₂	l ₁	d ₂	z	Ident No.	LMT-Code
6	20	90	6	4	2643750	66-791
8	25	100	8	6	2643751	66-793
10	30	100	10	6	2643752	66-795
12	38	100	12	8	2643753	66-797

■ = Hauptanwendung First choice
□ = Nebenanwendung Second choice

Vorschub-Korrektur-Faktoren f ₁ Feed correction factor f ₁											
v _f = n · z · f _z · f ₁											
CFRP			GFRP G10/Fiberglass			Phenol Phenolic					
a _e	a _p			a _e	a _p			a _e	a _p		
	1x	1,25x	2x		1x	1,25x	2x		1x	1,25x	2x
1 x d ₁	1			1 x d ₁	1			1 x d ₁	1		
0,33 x d ₁	1,4	1,4		0,33 x d ₁	1,4	1,4		0,33 x d ₁	1,4	1,4	
0,15 x d ₁	2	2	2	0,15 x d ₁	2	2	2	0,15 x d ₁	2	2	2
0,05 x d ₁	2,5	2,5	2,5	0,05 x d ₁	2,5	2,5	2,5	0,05 x d ₁	2,5	2,5	2,5

a_e = Hauptanwendung Width of cut in mm
a_p = Nebenanwendung Depth of cut in mm
d₁ = Durchmesser in mm Cutter diameter in mm
f₁ = Korrekturfaktor für v_f Correction factor for v_f
f_z = Vorschub pro Zahn in mm Feed per tooth in mm
n = Drehzahl in min⁻¹ Speed in min⁻¹
v_f = Vorschubgeschwindigkeit in mm/min
Feed rate in mm/min
z = Anzahl der Schneiden No. of teeth

Schnittwertempfehlungen Cutting data recommendations

	Werkstoff Material	Werkstoff-Nr. Material No.	DIN Bezeichnung Alt DIN Description Old	R _m /UTS (N/mm ²)	DIN Bezeichnung Neu DIN Description New	Schnitt- geschwindigkeit Cutting speed v _c (m/min)	Fräserdurchmesser Cutting diameter (mm)		
							Vorschub pro Zahn Feed per tooth f _z (mm/z.)		
							6	8-10	12
O	Faserverbundstoffe Composites		CFRP		CFRP	90-500	0,022	0,033	0,044
			GFRP		G10/Fiberglass	90-365	0,013	0,020	0,027
			Phenol		Phenolic	90-365	0,022	0,033	0,044

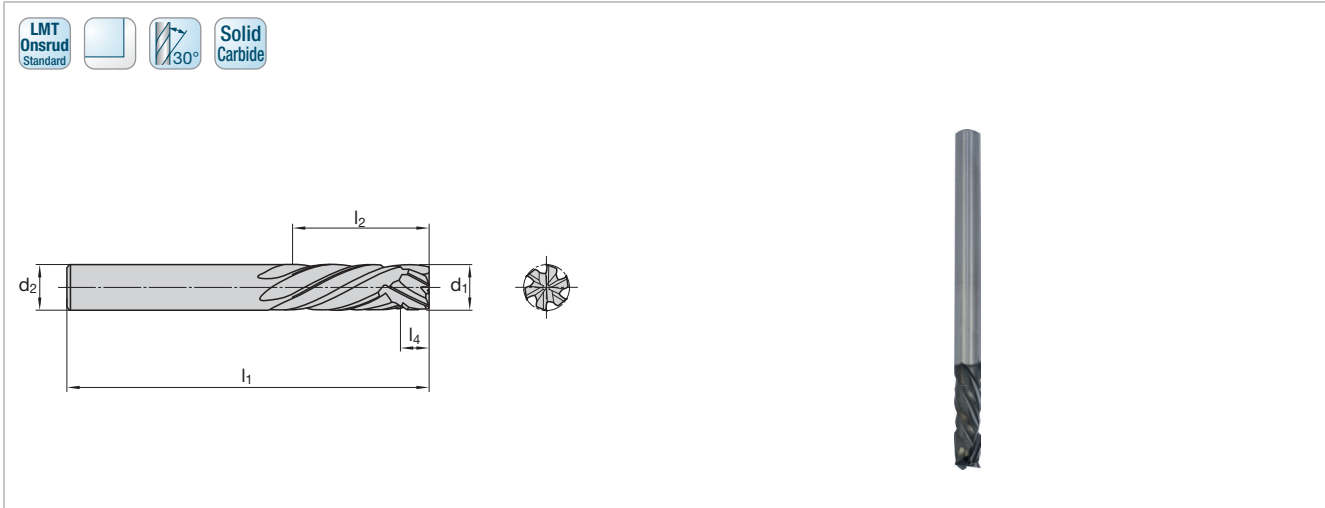

Katalog-Nr. Cat.-No.						66-800	
P							
M							
K							
N							
S							
H							
O						■	
d ₁	l ₂	l ₄	l ₁	d ₂	z	Ident No.	LMT-Code
6	20	7,75	90	6	4	2643761	66-852
8	25	8	100	8	4	2643762	66-858
10	25	8,5	100	10	6	2643763	66-864
12	25	9	100	12	6	2643764	66-870

■ = Hauptanwendung First choice
 □ = Nebenanwendung Second choice

Vorschub-Korrektur-Faktoren f ₁ Feed correction factor f ₁			
v _f = n · z · f _z · f ₁			
CFRP			
a _e	a _p		
	1x	1,25x	2x
1 x d ₁	1		
0,33 x d ₁	1,4	1,4	
0,15 x d ₁	2	2	2
0,06 x d ₁	2,5	2,5	2,5

a_e = Hauptanwendung Width of cut in mm
 a_p = Nebenanwendung Depth of cut in mm
 d₁ = Durchmesser in mm Cutter diameter in mm
 f₁ = Korrekturfaktor für v_f Correction factor for v_f
 f_z = Vorschub pro Zahn in mm Feed per tooth in mm
 n = Drehzahl in min⁻¹ Speed in min⁻¹
 v_f = Vorschubgeschwindigkeit in mm/min Feed rate in mm/min
 z = Anzahl der Schneiden No. of teeth

Schnittwertempfehlungen
Cutting data recommendations

	Werkstoff Material	Werkstoff-Nr. Material No.	DIN Bezeichnung Alt DIN Description Old	R _m /UTS (N/mm ²)	DIN Bezeichnung Neu DIN Description New	Schnitt- geschwindigkeit Cutting speed v _c (m/min)	Fräserdurchmesser Cutting diameter (mm)		
							Vorschub pro Zahn Feed per tooth f _z (mm/z.)		
							6	8-10	12
O	Faserverbundstoffe Composites		CFRP		CFRP	150-600	0,040	0,059	0,080

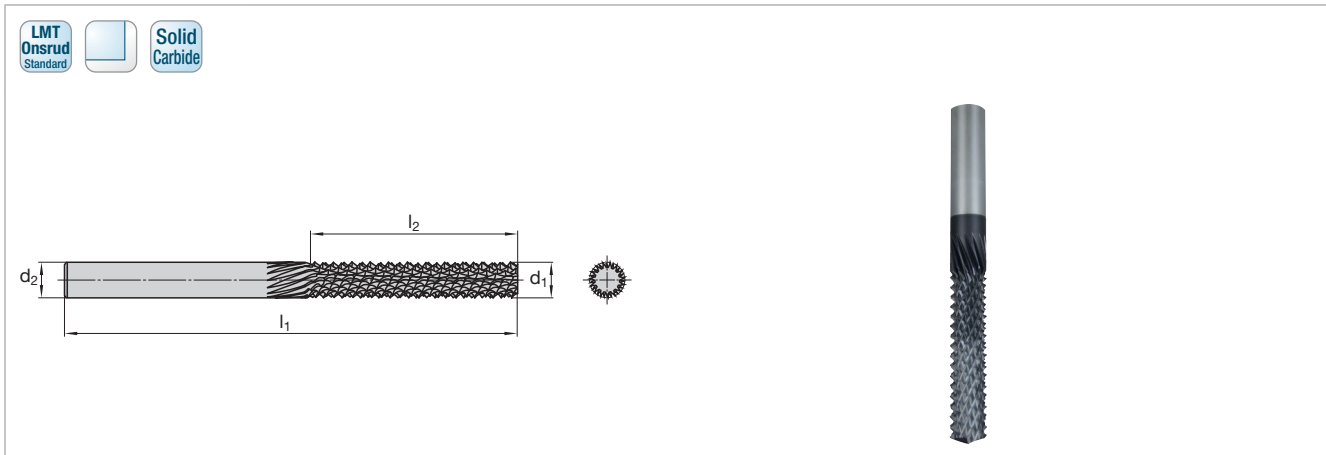

Katalog-Nr.	Cat.-No.	66-900
P		
M		
K		
N		
S		
H		
O		■

d ₁	l ₂	l ₁	d ₂	z	Ausführung Point style	Ident No.	LMT-Code
4	16	50	6	MULTI	Glatt No	7053814	66-971ALTIN
4	16	50	6	MULTI	Entgrater Burr	7053815	66-972ALTIN
4	16	50	6	MULTI	Fräser End mill	7053816	66-973ALTIN
4	16	50	6	MULTI	Bohrer Drill	7053817	66-974ALTIN
6	19	75	6	MULTI	Glatt No	7053818	66-975ALTIN
6	19	75	6	MULTI	Entgrater Burr	7053819	66-976ALTIN
6	19	75	6	MULTI	Fräser End mill	7053820	66-977ALTIN
6	19	75	6	MULTI	Bohrer Drill	7053821	66-978ALTIN
6	25	75	6	MULTI	Glatt No	7053822	66-979ALTIN
6	25	75	6	MULTI	Entgrater Burr	7053823	66-980ALTIN
6	25	75	6	MULTI	Fräser End mill	7051442	66-981ALTIN
6	25	75	6	MULTI	Bohrer Drill	7053371	66-982ALTIN
8	25	63	8	MULTI	Glatt No	7053824	66-983ALTIN
8	25	63	8	MULTI	Entgrater Burr	7053825	66-984ALTIN
8	25	63	8	MULTI	Fräser End mill	7050939	66-985ALTIN
8	25	63	8	MULTI	Bohrer Drill	7050489	66-986ALTIN
10	25	75	10	MULTI	Glatt No	7053826	66-987ALTIN
10	25	75	10	MULTI	Entgrater Burr	7053827	66-988ALTIN
10	25	75	10	MULTI	Fräser End mill	7050950	66-989ALTIN
10	25	75	10	MULTI	Bohrer Drill	7053829	66-990ALTIN
12	25	75	12	MULTI	Glatt No	7053830	66-991ALTIN
12	25	75	12	MULTI	Entgrater Burr	7053831	66-992ALTIN
12	25	75	12	MULTI	Fräser End mill	7053832	66-993ALTIN
12	25	75	12	MULTI	Bohrer Drill	7053833	66-994ALTIN

■ = Hauptanwendung First choice
□ = Nebenanwendung Second choice

Schnittwertempfehlungen Cutting data recommendations

	Werkstoff Material	Werkstoff-Nr. Material No.	DIN Bezeichnung Alt DIN Description Old	R _m /UTS (N/mm ²)	DIN Bezeichnung Neu DIN Description New	Schnitt- geschwindigkeit Cutting speed v _c (m/min)	Fräserdurchmesser Cutting diameter (mm)				
							Vorschub pro Zahn Feed per tooth f _z (mm/z.)				
							4	6	8	10	12
O	Faserverbundstoffe Composites		CFRP		CFRP	115-340	0,076	0,127	0,127	0,127	0,178
			GFRP		G10/Fiberglass						
			Phenol		Phenolic						

3-schneidiger Router 3 Flute solid carbide phenolic cutter

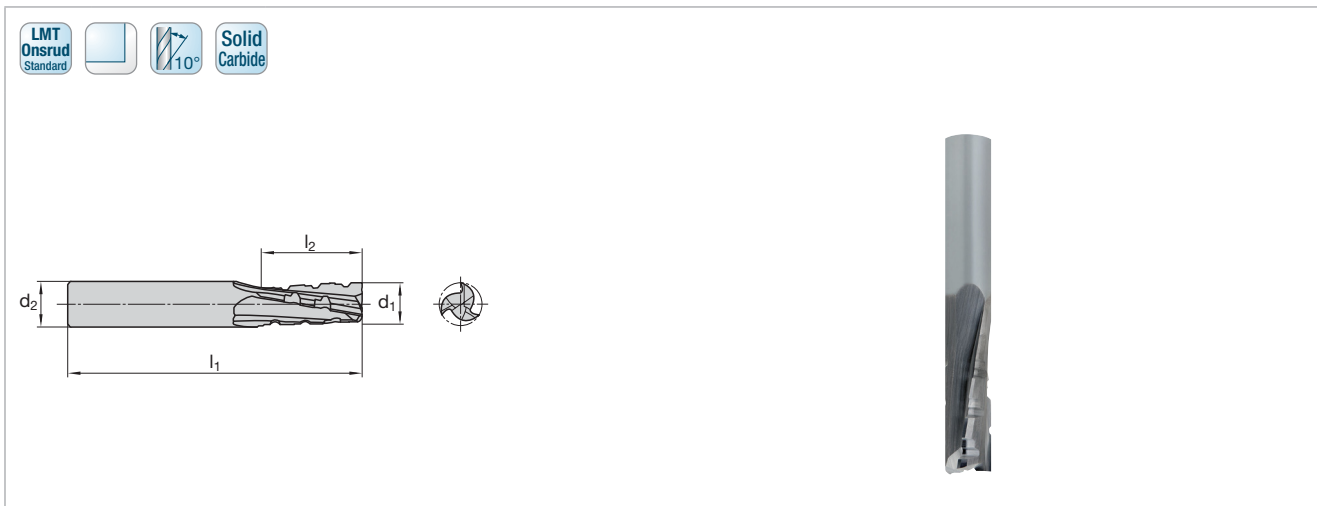

Katalog-Nr. Cat.-No.						67-200	
P							
M							
K							
N							
S							
H							
O	■						
d ₁	l ₂	l ₁	d ₂	z	Spirale Helix	Ident No.	LMT-Code
10	22	75	10	3	rechts right	2606149	67-207
10	22	75	10	3	links left	2606150	67-208
12	28	75	12	3	rechts right	2606151	67-209
12	28	75	12	3	links left	2606152	67-210

■ = Hauptanwendung First choice
□ = Nebenanwendung Second choice

Schnittwertempfehlungen Cutting data recommendations

	Werkstoff Material	Werkstoff-Nr. Material No.	DIN Bezeichnung Alt DIN Description Old	R _m /UTS (N/mm ²)	DIN Bezeichnung Neu DIN Description New	Schnitt- geschwindigkeit Cutting speed v _c (m/min)	Fräserdurchmesser Cutting diameter (mm)	
							Vorschub pro Zahn Feed per tooth f _z (mm/z.)	
O	Faserverbundstoffe Composites		CFRP		CFRP	315-350	10	12
			GFRP		G10/Fiberglass		0,178	0,178
			Phenol		Phenolic			

Fräsen mit Schlitzzähnen aus Vollhartmetall
Milling with solid carbide end mills

Katalog-Nr. Cat.-No.					68-200		
P							
M							
K							
N							
S							
H							
O						■	
d ₁	l ₂	l ₁	d ₂	z	Ident No.	LMT-Code	
6	20	76	6	2	7052123	68-213M	
10	25	88	10	2	7053914	68-226M	
12	32	100	12	2	7053915	68-236M	

■ = Hauptanwendung First choice
□ = Nebenanwendung Second choice

Schnittwertempfehlungen Cutting data recommendations

	Werkstoff Material	Werkstoff-Nr. Material No.	DIN Bezeichnung Alt DIN Description Old	R _m /UTS (N/mm ²)	DIN Bezeichnung Neu DIN Description New	Schnitt- geschwindigkeit Cutting speed v _c (m/min)	Fräserdurchmesser Cutting diameter (mm)		
							Vorschub pro Zahn Feed per tooth f _z (mm/z.)		
							6	10	12
O	Faserverbundstoffe Composites		CFRP		CFRP	225-600	0,020	0,040	0,040
			GFRP		G10/Fiberglass				
			Phenol		Phenolic				

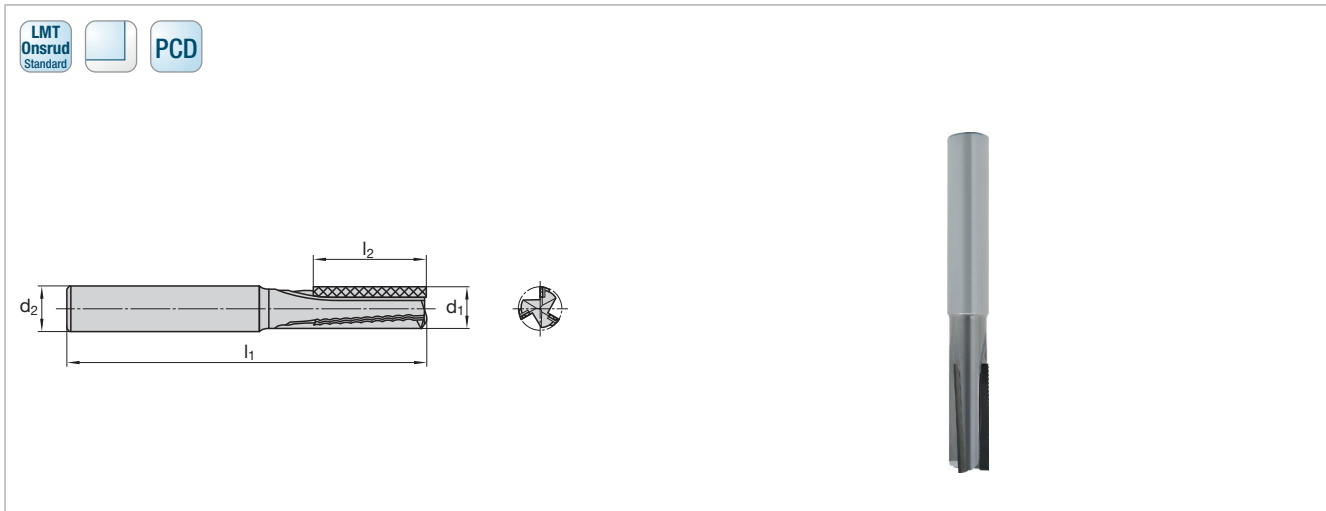

Katalog-Nr. Cat.-No.					68-300		
P							
M							
K							
N							
S							
H							
O						■	
d ₁	l ₂	l ₁	d ₂	z	Ident No.	LMT-Code	
8	10	76	8	3	7052122	68-310	
10	14	100	10	3	7053902	68-325	
12	14	100	12	3	7053903	68-330	
12	26	100	12	3	7053904	68-335	
16	26	100	16	3	7053905	68-355	

■ = Hauptanwendung First choice
□ = Nebenanwendung Second choice

Schnittwertempfehlungen Cutting data recommendations

	Werkstoff Material	Werkstoff-Nr. Material No.	DIN Bezeichnung Alt DIN Description Old	R _m /UTS (N/mm ²)	DIN Bezeichnung Neu DIN Description New	Schnitt- geschwindigkeit Cutting speed v _c (m/min)	Fräserdurchmesser Cutting diameter (mm)			
							Vorschub pro Zahn Feed per tooth f _z (mm/z.)			
							8	10	12	16
O	Faserverbundstoffe Composites		CFRP		CFRP	300-800	0,040	0,040	0,040	0,080
			GFRP		G10/Fiberglass					
			Phenol		Phenolic					



Katalog-Nr. Cat.-No.		29-050					
P							
M							
K							
N							
S							
H							
O			■				
d ₁	l ₂	l ₁	d ₂	z	R	Ident No.	LMT-Code
6	32	100	6	6	3	7053967	29-054
10	60	120	10	14	5	7053968	29-056
12	75	120	12	20	6	7053969	29-061
20	75	120	20	20	10	7053970	29-065

■ = Hauptanwendung First choice □ = Nebenanwendung Second choice

Honeycomb Werkzeug Honeycomb hogger						
d ₁	l ₂	l ₁	d ₂	Ident No.	LMT-Code	
44,24	12,7	76,2	25,4	7054044	29-083	
62,23	15,875	76,2	25,4	7054048	29-093	

Optionen für Schneidmesser Cutting blade options									
Schneiden-Ø Blade diameter	Hartmetall Solid carbide		Hartmetall mit Zähnen Solid carbide w/ teeth		Diamant bestückt Diamond plated		HSS Messer HSS saw		
	Ident No.	LMT-Code	Ident No.	LMT-Code	Ident No.	LMT-Code	Ident No.	LMT-Code	
45	7054084	30-026	7054113	30-326	7054096	30-126	7054103	30-226	
63	7054088	30-036	7054115	30-336	7054098	30-136	7054105	30-236	

Ersatzteile Spare parts									
Adapter Ring					Schraube Screw				
Ident No.		LMT-Code			Ident No.		LMT-Code		
7054081		30-020-3			7054082		30-020-4		
7054085		30-030-3			7054086		30-030-4		

Schnittwertempfehlungen Cutting data recommendations

	Werkstoff Material	Werkstoff-Nr. Material No.	DIN Bezeichnung Alt DIN Description Old	R _m /UTS (N/mm ²)	DIN Bezeichnung Neu DIN Description New	Vorschub- geschwindig- keit Table feed v _f (mm/min)	Fräserdurchmesser Cutting diameter (mm)					
							Max. Drehzahl Max. RPM (U/min ⁻¹)					
							6	10	12	20	45	63
O	Wabenmaterial Honeycomb		Papier		Paper based	20300	25000	25000	25000	25000	18000	15000
			Papier mit Faser- verstärkung		Paper based with fiber reinforcement	20300						
			Fiberglas		Fiberglass	20300						
			Phenolharz		Phenolic	20300						
			Aramid		Aramid	2500						

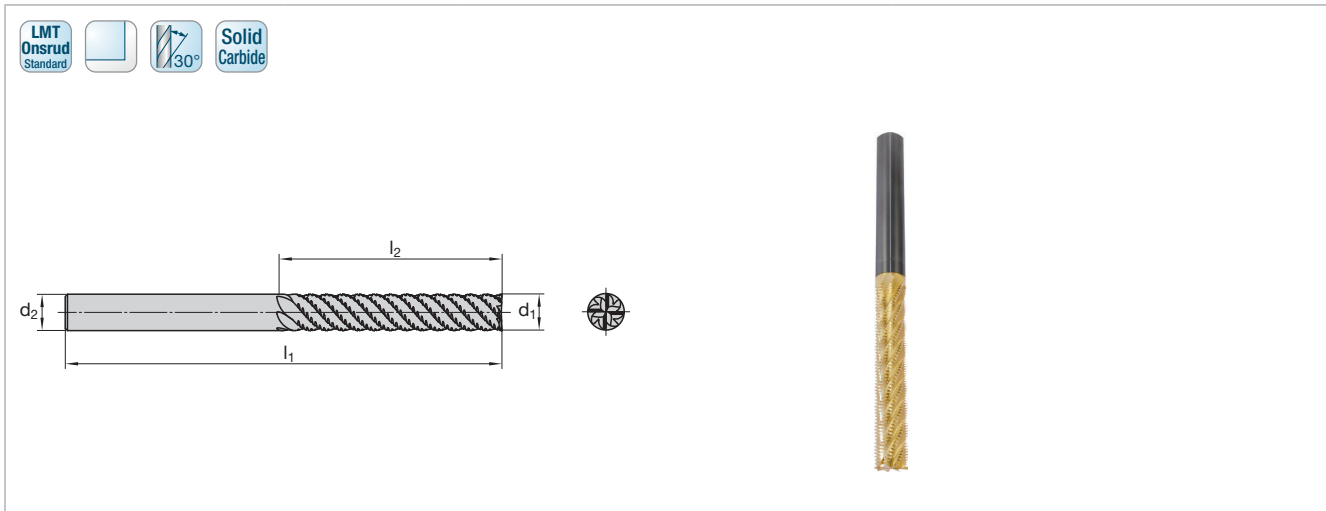

Katalog-Nr. Cat.-No.					29-100		
P							
M							
K							
N							
S							
H							
O						■	
d ₁	l ₂	l ₁	d ₂	z	Ident No.	LMT-Code	
12	60	150	12	8	7053971	29-120	
16	80	150	16	10	7053972	29-135	

■ = Hauptanwendung First choice
□ = Nebenanwendung Second choice

Schnittwertempfehlungen Cutting data recommendations

Werkstoff Material	Werkstoff-Nr. Material No.	DIN Bezeichnung Alt DIN Description Old	R _m /UTS (N/mm ²)	DIN Bezeichnung Neu DIN Description New	Vorschub- geschwindigkeit Table feed v _f (mm/min)	Fräserdurchmesser Cutting diameter (mm)	
						Max. Drehzahl Max. RPM (U/min ⁻¹)	
						12	16
O Wabenmaterial Honeycomb		Aluminium		Aluminum based	2500	25000	25000
		Papier		Paper based	10200		
		Papier mit Faser- verstärkung		Paper based with fiber reinforcement	20300		
		Fiberglas		Fiberglass	15200		
		Phenolharz		Phenolic	15200		
		Kohlefaser		Carbon Fiber	20300		
		Aramid		Aramid	20300		

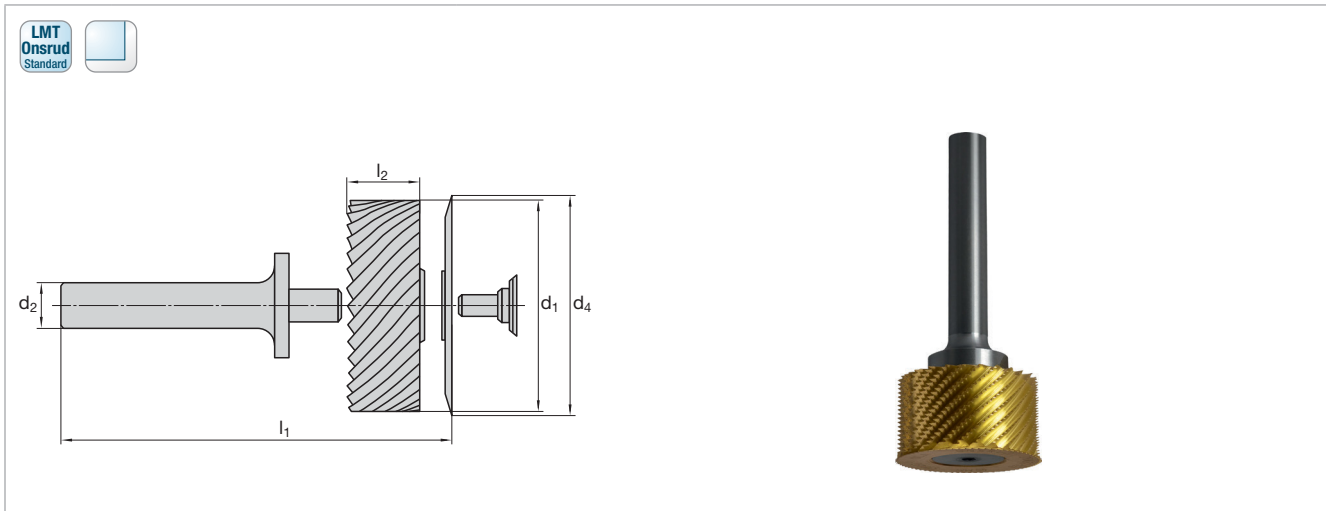

Katalog-Nr. Cat.-No.	32-200
P	
M	
K	
N	
S	
H	
O	■

■ = Hauptanwendung First choice
□ = Nebenanwendung Second choice

Honeycomb Werkzeug Honeycomb Hogger			
d ₁	l ₂	Ident No.	LMT-Code
43,69	25,4	2605363	32-220
61,47	25,4	7092853	32-230

Schaft Arbor			
l ₁	d ₂	Ident No.	LMT-Code
101,6	12,7	7092840	32-231
101,6	12,7	7092840	32-231

Optionen für Schneidmesser Cutting Blade Options				
d ₄ Schneiden-Ø Blade diameter	Hartmetall Solid carbide		Hartmetall verzahnt Solid carbide with teeth	
	Ident No.	LMT-Code	Ident No.	LMT-Code
45	2605364	32-426	2640839	32-526
63	2640839	32-436	2609040	32-536

Ersatzteile Spare parts			
Ring Spacer		Schraube Screw	
Ident No.	LMT-Code	Ident No.	LMT-Code
7092842	32-231-3	7092844	32-231-4
7092842	32-231-3	7092844	32-231-4

	Werkstoff Material	DIN Bezeichnung Alt DIN Description Old	DIN Bezeichnung Neu DIN Description New	Vorschubgeschwindigkeit Table feed v_f (mm/min)				Fräserdurchmesser Cutting diameter (mm)	
				Hartmetall Solid carbide	Hartmetall mit Zähnen Solid carbide with teeth	Diamant- beschichtete Säge Diamond saw	HSS	Max. Drehzahl Max. RPM (U/min ⁻¹)	
								45	63
O	Wabenmaterial Honeycomb	Aluminium	Aluminum based	2500	2500	Nicht anwenden	3800	18000	15000
		Papier	Paper based	10200	10200	Do not use	6400		
		Papier mit Faserverstärkung	Paper based with fiber reinforcement	20300	20300	10200	3800		
		Fiberglas	Fiberglass	15200	15200	15200	Nicht anwenden Do not use		
		Phenolharz	Phenolic	5100	5100	10200			
		Kohlefaser	Carbon Fiber	Nicht anwenden Do not use	Nicht anwenden Do not use	20300			
		Aramid	Aramid	20300	20300	10200			

						65-200B	
Katalog-Nr. Cat.-No.							
P							
M							
K							
N							
S							
H							
O						■	
d₁	l₂	l₁	d₂	z	R	Ident No.	LMT-Code
3	12	64	3	2	1,5	7053979	65-280B
6	20	76	6	2	3	7053980	65-285B
8	25	76	8	2	4	7053981	65-290B
10	30	76	10	2	5	7053982	65-295B

■ = Hauptanwendung First choice
□ = Nebenanwendung Second choice

Schnittwertempfehlungen Cutting data recommendations

	Werkstoff Material	Werkstoff-Nr. Material No.	DIN Bezeichnung Alt DIN Description Old	R _m /UTS (N/mm ²)	DIN Bezeichnung Neu DIN Description New	Schnitt- geschwindigkeit Cutting speed v _c (m/min)	Fräserdurchmesser Cutting diameter (mm)			
							Vorschub pro Zahn Feed per tooth f _z (mm/z.)			
							3	6	8	10
O	Weicher Kunststoff Soft Plastic		Thermoplaste: PVC, PE, PP, ...	40-70	Thermoplaste: PVC, PE, PP, ...	170-575	0,06	0,10	0,10	0,12
	Harter Kunststoff Hard Plastic		Duroplaste: Bakelit, Melamin, MF, MPF	20-40	Duroplaste: Bakelit, Melamin, MF, MPF	170-575	0,06	0,10	0,10	0,12

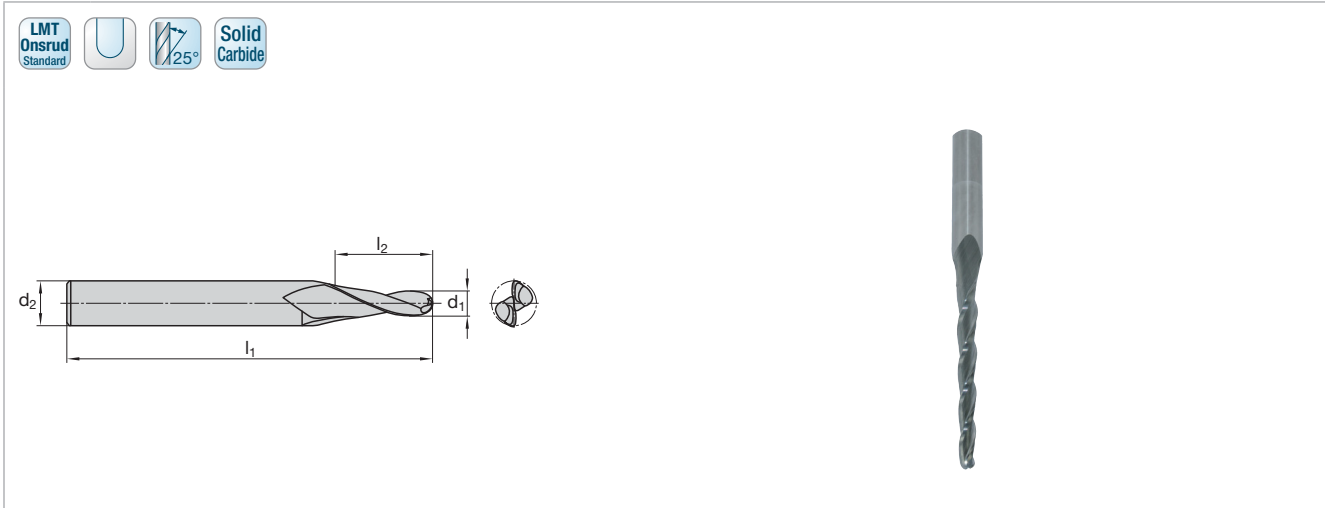

Katalog-Nr. Cat.-No.		77-100						
P								
M								
K								
N								
S								
H								
O								■
d ₁	l ₂	l ₁	d ₂	z	Winkel Angle	Radius Radii	Ident No.	LMT-Code
3	39	76	6	3	1°	1,5	9125270	77-102M
3	25	76	6	3	3°	1,5	9125271	77-104M
3	19	76	6	3	5°	1,5	9125272	77-106M
3	12	76	6	3	7°	1,5	9125273	77-108M
6	50	100	12	2	3°	3	9125274	77-112M
6	35	100	12	2	5°	3	9125275	77-114M
6	25	100	12	2	7°	3	9125276	77-116M

■ = Hauptanwendung First choice
□ = Nebenanwendung Second choice

Schnittwertempfehlungen Cutting data recommendations

	Werkstoff Material	Werkstoff-Nr. Material No.	DIN Bezeichnung Alt DIN Description Old	R _m /UTS (N/mm ²)	DIN Bezeichnung Neu DIN Description New	Schnitt- geschwindigkeit Cutting speed v _c (m/min)	Fräserdurchmesser Cutting diameter (mm)	
							Vorschub pro Zahn Feed per tooth f _z (mm/z.)	
							3	6
O	Weicher Kunststoff Soft Plastic		Thermoplaste: PVC, PE, PP, ...	40-70	Thermoplaste: PVC, PE, PP, ...	170-350	0,016	0,022
	Harter Kunststoff Hard Plastic		Duroplaste: Bakelit, Melamin, MF, MPF	20-40	Duroplaste: Bakelit, Melamin, MF, MPF	170-350	0,016	0,022

Katalog-Nr. Cat.-No.	68-400						
P							
M							
K							
N							
S							
H							
O	■						
d ₁	l ₂	l ₁	d ₂	z	R	Ident No.	LMT-Code
6	10	76	6	2	3	2609049	68-440
8	10	76	8	2	4	2609050	68-445
10	12	76	10	2	5	2609051	68-450
12	20	100	12	2	6	7088736	68-455

■ = Hauptanwendung First choice
□ = Nebenanwendung Second choice

Schnittwertempfehlungen Cutting data recommendations

	Werkstoff Material	Werkstoff-Nr. Material No.	DIN Bezeichnung Alt DIN Description Old	R _m /UTS (N/mm ²)	DIN Bezeichnung Neu DIN Description New	Schnitt- geschwindigkeit Cutting speed v _c (m/min)	Fräserdurchmesser Cutting diameter (mm)			
							Vorschub pro Zahn Feed per tooth f _z (mm/z.)			
							6	8	10	12
O	Faserverbundstoffe Composites		CFRP		CFRP	225-600	0,02	0,02	0,03	0,04
			GFRP		G10/Fiberglass					
			Phenol		Phenolic					



Fräsen mit Schlitzzäsen aus Vollhartmetall
Milling with solid carbide end mills

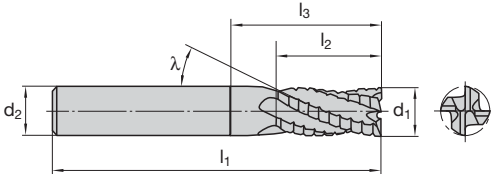

Katalog-Nr. Cat.-No.						1563C		1564C	
P						■		■	
M									
K						■		■	
N									
S									
H									
O									
d ₁	l ₂	l ₁	l ₃	d ₂	z	Ident No.	LMT-Code	Ident No.	LMT-Code
lang long									
6	13	57	21	6	3	1123000	EM-RFT45 6x13/21 3SA	1123010	EM-RFT45 6x13/21 3SB
8	19	63	27	8	3	1123001	EM-RFT45 8x19/27 3SA	1123012	EM-RFT45 8x19/27 3SB
10	22	72	32	10	4	1123003	EM-RFT45 10x22/32 4SA	1123013	EM-RFT45 10x22/32 4SB
12	26	83	38	12	4	1123004	EM-RFT45 12x26/38 4SA	1123014	EM-RFT45 12x26/38 4SB
16	32	92	44	16	4	1123006	EM-RFT45 16x32/44 4SA	1123016	EM-RFT45 16x32/44 4SB
18	32	92	44	18	4	1123007	EM-RFT45 18x32/44 4SA	–	–
20	38	104	54	20	4	1123008	EM-RFT45 20x38/54 4SA	1123018	EM-RFT45 20x38/54 4SB

■ = Hauptanwendung First choice
 □ = Nebenanwendung Second choice

Schnittwertempfehlungen ab Seite 134
 Cutting data recommendations starting page 134

Kantenschutzfase Edge protection chamfer	d ₁	b
	6–8	0,3
	10	0,4
	12–20	0,5



Katalog-Nr. Cat.-No.						1591C		1592C	
P						■		■	
M									
K						■		■	
N									
S									
H									
O									
d ₁	l ₂	l ₁	l ₃	d ₂	z	Ident No.	LMT-Code	Ident No.	LMT-Code
lang long									
10	22	72	32	10	4	1121927	EM-RFT25 10x22/32 4SA	1121935	EM-RFT25 10x22/32 4SB
12	26	83	38	12	4	1121928	EM-RFT25 12x26/38 4SA	1121936	EM-RFT25 12x26/38 4SB
16	32	92	44	16	4	1121930	EM-RFT25 16x32/44 4SA	1121938	EM-RFT25 16x32/44 4SB
20	38	104	54	20	4	1121933	EM-RFT25 20x38/54 4SA	1121940	EM-RFT25 20x38/54 4SB
25	45	121	65	25	4	1122005	EM-RFT25 25x45/65 4SA	1122004	EM-RFT25 25x45/65 4SB

■ = Hauptanwendung First choice
 □ = Nebenanwendung Second choice

Schnittwertempfehlungen ab Seite 134
 Cutting data recommendations starting page 134

Kantenschutzfase Edge protection chamfer	d ₁	b
	8	0,3
	10	0,4
	12-20	0,5
	25	0,6

Katalog-Nr.		Cat.-No.		1426C		1425C			
P		■		■		■			
M		□		□		□			
K		■		■		■			
N		□		□		□			
S									
H									
O									
d ₁	l ₂	l ₁	l ₃	d ₂	z	Ident No.	LMT-Code	Ident No.	LMT-Code
kurz short									
2	3	50	14	6	2	1122346	EM-N 2x3/14 2SA	1100091	EM-N 2x3/14 2SB
3	4	50	14	6	2	1122358	EM-N 3x4/14 2SA	1100092	EM-N 3x4/14 2SB
4	5	54	18	6	2	1122370	EM-N 4x5/18 2SA	1100093	EM-N 4x5/18 2SB
5	6	54	18	6	2	1122394	EM-N 5x6/18 2SA	1100094	EM-N 5x6/18 2SB
6	7	54	18	6	2	1122420	EM-N 6x7/18 2SA	1100095	EM-N 6x7/18 2SB
8	9	58	22	8	2	1122447	EM-N 8x9/22 2SA	1100096	EM-N 8x9/22 2SB
10	11	66	26	10	2	1122473	EM-N 10x11/26 2SA	1100097	EM-N 10x11/26 2SB
12	12	73	28	12	2	1122498	EM-N 12x12/28 2SA	1100098	EM-N 12x12/28 2SB
lang long									
2	6	38	10	3	2	1122246	EM-N 2x6/10 2SA	-	-
3	7	38	10	3	2	1122258	EM-N 3x7/10 2SA	-	-
4	8	50	22	4	2	1122271	EM-N 4x8/22 2SA	-	-
5	10	50	22	5	2	1122285	EM-N 5x10/22 2SA	-	-
6	10	57	21	6	2	1122298	EM-N 6x10/21 2SA	1100117	EM-N 6x10/21 2SB
8	16	63	27	8	2	1122323	EM-N 8x16/27 2SA	1100118	EM-N 8x16/27 2SB
10	19	72	32	10	2	1122347	EM-N 10x19/32 2SA	1100119	EM-N 10x19/32 2SB
12	22	83	38	12	2	1122371	EM-N 12x22/38 2SA	1100120	EM-N 12x22/38 2SB

Schnittwertempfehlungen ab Seite 134
Cutting data recommendations starting page 134

■ = Hauptanwendung First choice
□ = Nebenanwendung Second choice

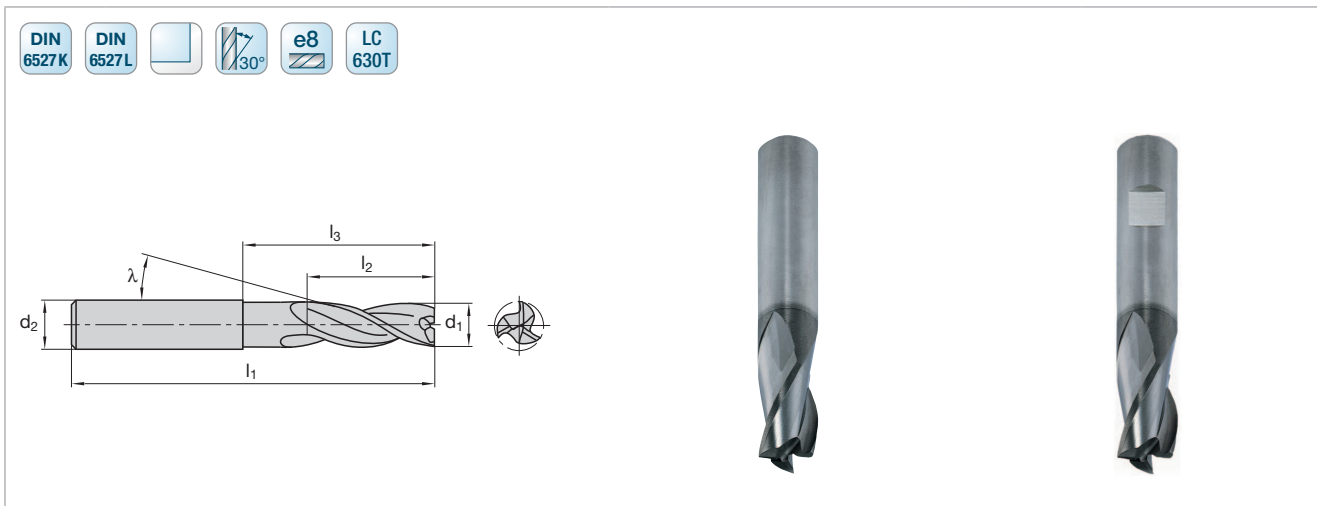

Katalog-Nr. Cat.-No.						1428C		1429C	
P						■		■	
M						□		□	
K						■		■	
N						□		□	
S									
H									
O									
d ₁	l ₂	l ₁	l ₃	d ₂	z	Ident No.	LMT-Code	Ident No.	LMT-Code
kurz short									
4	5	54	18	6	3	1122116	EM-N 4x5/18 3SA	1100171	EM-N 4x5/18 3SB
6	7	54	18	6	3	1122142	EM-N 6x7/18 3SA	1100173	EM-N 6x7/18 3SB
8	9	58	22	8	3	1122155	EM-N 8x9/22 3SA	1100174	EM-N 8x9/22 3SB
10	11	66	26	10	3	1122168	EM-N 10x11/26 3SA	1100175	EM-N 10x11/26 3SB
12	12	73	28	12	3	1122181	EM-N 12x12/28 3SA	1100176	EM-N 12x12/28 3SB
lang long									
2	6	38	10	3	3	1122007	EM-N 2x6/10 3SA	-	-
3	7	38	10	3	3	1122020	EM-N 3x7/10 3SA	-	-
4	8	50	22	4	3	1122034	EM-N 4x8/22 3SA	-	-
5	10	50	22	5	3	1122046	EM-N 5x10/22 3SA	-	-
6	10	57	21	6	3	1122060	EM-N 6x10/21 3SA	1100181	EM-N 6x10/21 3SB
8	16	63	27	8	3	1122087	EM-N 8x16/27 3SA	1100182	EM-N 8x16/27 3SB
10	19	72	32	10	3	1122113	EM-N 10x19/32 3SA	1100183	EM-N 10x19/32 3SB
12	22	83	38	12	3	1122139	EM-N 12x22/38 3SA	1100184	EM-N 12x22/38 3SB
14	26	83	38	14	3	1122152	EM-N 14x26/38 3SA	1100185	EM-N 14x26/38 3SB

Schnittwertempfehlungen ab Seite 134
Cutting data recommendations starting page 134

■ = Hauptanwendung First choice
□ = Nebenanwendung Second choice

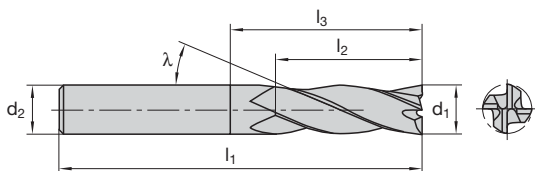

Katalog-Nr. Cat.-No.						1585		1584	
P						■		■	
M						□		□	
K									
N						□		□	
S									
H									
O									
d ₁	l ₂	l ₁	l ₃	d ₂	z	Ident No.	LMT-Code	Ident No.	LMT-Code
kurz short									
4	8	54	18	6	4	1120214	EM-N 4x8/18 4SA	1120215	EM-N 4x8/18 4SB
6	10	54	18	6	4	1300027	EM-N 6x10/18 4SA	1143359	EM-N 6x10/18 4SB
8	12	58	22	8	4	1300028	EM-N 8x12/22 4SA	1143361	EM-N 8x12/22 4SB
10	14	66	26	10	4	1300029	EM-N 10x14/26 4SA	1143363	EM-N 10x14/26 4SB
12	16	73	28	12	4	1300030	EM-N 12x16/28 4SA	1143365	EM-N 12x16/28 4SB
16	22	82	34	16	4	1300032	EM-N 16x22/34 4SA	1143367	EM-N 16x22/34 4SB
lang long									
4	11	50	22	4	4	1142765	EM-N 4x11/22 4SA	-	-
5	13	50	22	5	4	1142767	EM-N 5x13/22 4SA	-	-
6	13	57	21	6	4	1142769	EM-N 6x13/21 4SA	1142704	EM-N 6x13/21 4SB
8	19	63	27	8	4	1142773	EM-N 8x19/27 4SA	1142713	EM-N 8x19/27 4SB
10	22	72	32	10	4	1142776	EM-N 10x22/32 4SA	1142722	EM-N 10x22/32 4SB
12	26	83	38	12	4	1142780	EM-N 12x26/38 4SA	1142731	EM-N 12x26/38 4SB
14	26	83	38	14	4	1142783	EM-N 14x26/38 4SA	1142608	EM-N 14x26/38 4SB
16	32	92	44	16	4	1142785	EM-N 16x32/44 4SA	1142740	EM-N 16x32/44 4SB
20	38	104	54	20	4	1142789	EM-N 20x38/54 4SA	1142759	EM-N 20x38/54 4SB

Schnittwertempfehlungen ab Seite 134
Cutting data recommendations starting page 134

■ = Hauptanwendung First choice
□ = Nebenanwendung Second choice



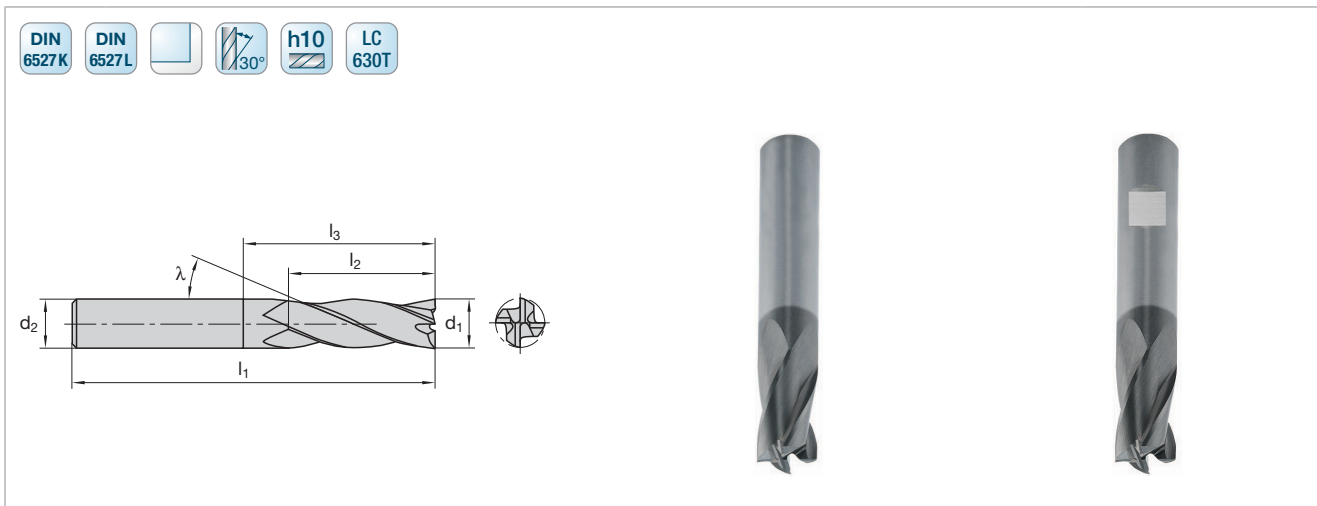

Katalog-Nr. Cat.-No.						1585C		1584C	
P						■		■	
M						□		□	
K						■		■	
N						□		□	
S									
H									
O									
d ₁	l ₂	l ₁	l ₃	d ₂	z	Ident No.	LMT-Code	Ident No.	LMT-Code
kurz short									
4	8	54	18	6	4	1122871	EM-N 4x8/18 4SA	1100206	EM-N 4x8/18 4SB
6	10	54	18	6	4	1122584	EM-N 6x10/18 4SA	1100207	EM-N 6x10/18 4SB
8	12	58	22	8	4	1122596	EM-N 8x12/22 4SA	1100208	EM-N 8x12/22 4SB
10	14	66	26	10	4	1122608	EM-N 10x14/26 4SA	1100209	EM-N 10x14/26 4SB
12	16	73	28	12	4	1122620	EM-N 12x16/28 4SA	1100210	EM-N 12x16/28 4SB
14	18	75	30	14	4	1122633	EM-N 14x18/30 4SA	1100211	EM-N 14x18/30 4SB
16	22	82	34	16	4	1122645	EM-N 16x22/34 4SA	1100212	EM-N 16x22/34 4SB
lang long									
4	11	50	22	4	4	1122422	EM-N 4x11/22 4SA	-	-
5	13	50	22	6	4	1122436	EM-N 5x13/22 4SA	-	-
6	13	57	21	6	4	1122449	EM-N 6x13/21 4SA	1100215	EM-N 6x13/21 4SB
8	19	63	27	8	4	1122475	EM-N 8x19/27 4SA	1100216	EM-N 8x19/27 4SB
10	22	72	32	10	4	1122500	EM-N 10x22/32 4SA	1100217	EM-N 10x22/32 4SB
12	26	83	38	12	4	1122536	EM-N 12x26/38 4SA	1100218	EM-N 12x26/38 4SB
14	26	83	38	14	4	1122548	EM-N 14x26/38 4SA	1100219	EM-N 14x26/38 4SB
16	32	92	44	16	4	1122560	EM-N 16x32/44 4SA	1100220	EM-N 16x32/44 4SB
20	38	104	54	20	4	1122585	EM-N 20x38/54 4SA	1100222	EM-N 20x38/54 4SB
25	45	121	65	25	4	-	-	1110080	EM-N 25x45/65 4SB

Schnittwertempfehlungen ab Seite 134
 Cutting data recommendations starting page 134

■ = Hauptanwendung First choice
 □ = Nebenanwendung Second choice

Schnittwertempfehlungen für Typ N, RFT, universale Schafffräser
Cutting data recommendations for type N, RFT, universal end mills

				DIN Bezeichnung Alt DIN Description Old	R_m/UTS (N/mm²)	DIN Bezeichnung Neu DIN Description New
	Werkstoff	Material	Werkstoff-Nr. Material No.			
P	Unlegierter Baustahl + Automatenstahl	Plain carbon steel + free cutting steel	1.0570	St52-3	-700	S355J2G3
			1.1730	C45	-800	C45U
			1.0715	9SMn28	-700	11SMn30
			1.1191 1.7219	Ck45 26CrMo4	500-950	C45E 26CrMo4-2
	Vergütungsstahl, mittelfest	Heat-treatment steel, medium strength	1.7225	42CrMo4	500-950	42CrMo4
	Stahlguss	Cast steel	1.8159	51CrV4		51CrV4
	Einsatzstahl	Case hardening steel	1.0416	GS40	-950	GS40
	Rost- und säurebe- ständiger Stahl, ferritisch, martensitisch	Stainless steel, ferritic, martensitic	1.7131	16MnCr5	-950	16MnCr5
			1.4006	X10Cr13	500-950	X12Cr13
			1.4104 1.4122	X12CrMoS17 X35CrMo17		X14CrMoS17 X39CrMo17-1
	Vergütungsstahl, hochfest	Heat-treatment steel, high strength	1.7225	42CrMo4	950-1400	42CrMo4
	Nitrierstahl, vergütet	Nitriding steel, heat treated	1.6580	30CrNiMo8		30CrNiMo8
			1.8504	34CrAl6	950-1400	34CrAl6
	Werkzeugstahl	Tool steel	1.2344	X40CrMoV5.1	-900	X40CrMoV5-1
			1.2343	X38CrMoV5 1	950-1400	X37CrMoV5-1
			1.2379	X155CrVMo12 1	-950	X153CrMoV12-1
1.2358			60CrMoV18-5	850-1000	60CrMoV18-5	
1.2080			X210Cr12	950-1400	X210Cr12	
1.2714			55NiCrMoV7	1100-1350	55NiCrMoV7	
1.2311			40CrMnMo7	-1100	40CrMnMo7	
1.2312			40CrMnNiMoS8.6	-1150	40CrMnNiMoS8-6	
1.2316			X38CrMo16	-1100	X38CrMo16	
1.2738			45CrMnNiMo8.6.4	950-1150	45CrMnNiMo8-6-4	
M	Rost- und säurebe- ständiger Stahl, austenitisch	Stainless steel, austenitic	1.4301	X2CrNiMo17-12-2	500-950	X5CrNiMo18-10
			1.4404	X6CrNiMoTi17-12-2		X2CrNiMo17-12-2
			1.4571	X10CrNiMoTi18		X10CrNiMoTi18
	Rost- und säurebe- ständiger Stahl, martensitisch aushärtbar	Stainless steel, martensitic steel	1.2709	X3NiCoMoTi18-9-5	800-1000	X3NiCoMoTi18-9-5
		1.4542	X5CrNiCuNb16-4		X5CrNiCuNb16-4	
		1.4568	X7CrNiAl17-7		X7CrNiAl17-7	
K	Grauguss	Grey cast iron	0.6025	GG25	100-400 (120-260 HB)	EN-GJ1-250
	Legierter Grauguss	Alloyed grey cast iron	0.6678	GGL-NiCr35 2	150-250 (160-230 HB)	EN-GJLA-XNiCr35-2
	Sphäroguss	Nodular cast iron	0.7060 0.7070	GGG60 GGG70L	400-800 (120-310 HB)	EN-GJS-600-3 EN-GJS-700-2U
	Temperguss	Malleable cast iron	0.8155	GTS55	350-700 (150-280 HB)	EN-GJMB-550-4
N	Aluminium-Legierungen, kurzspanend	Aluminium alloys, short chipping	3.2581	G-AlSi12	-400	G-IGK-AlSi12
	Aluminium-Legierungen, langspanend	Aluminium alloys, long chipping	3.3535	AlMg3	-550	AlMg3
	Kupfer-Legierungen, kurzspanend	Copper alloys, short chipping	3.4365	AlZnMgCu1,5		AlZnMgCu1,5
	Kupfer-Legierungen, langspanend	Copper alloys, long chipping	2.0402	MS58	-500	CuZn40Pb2
	Thermoplaste	Thermoplastics	2.0320 2.0975	MS63 CuAl10Ni	300-500	CuZn37 CuAl10Fe5Ni5-C
	Duroplaste	Duroplastics		PVC	40-70	PVC
	Graphit	Graphite		Bakelit, Melamin	20-40	Bakelit, Melamin
S	Titan-Legierungen, mittelfest	Titanium alloys, medium strength	3.7115 3.7164	TiAl5Sn2,5 TiAl6V4	-950	TiAl5Sn2-5 TiAl6V4
	Titan-Legierungen, hochfest	Titanium alloys, high strength	3.7174	TiAl6Sn2	900-1400	TiAl6V6Sn2
	Nickelbasis-Legierungen, mittelfest	Nickel based alloys, medium strength	2.4670	NiCr12Al6MoNb	-950	NiCr12Al6MoNb
	Nickelbasis-Legierungen, hochwarmfest	Heat resistant nickel based alloys, high strength	2.4668	NiCr19Fe19NbMo	900-1400	Inconel 718 NiCr19Fe19Nb5Mo3

Bitte beachten Sie die Werkstoffempfehlung auf der jeweiligen Produktseite.

Please take notice of the material recommendations at each catalogpage of the product.

Hinweise zur Ermittlung des effektiven Schneidendurchmessers bei Kugelfräsern auf Seite XXX.

Hints for calculation of the effective cutting diameter of ball nose end mills on page XXX.

Schnittgeschwindigkeit Cutting speed v_c (m/min)		Fräserdurchmesser Cutting diameter (mm)			
		Vorschub pro Zahn Feed per tooth f_z (mm/z.)			
Hartmetall Carbide		Ø 2-4	Ø 5-10	Ø 11-16	Ø >16
beschichtet coated	unbeschichtet uncoated				
230	185	0,03	0,06	0,09	0,15
200	160	0,025	0,06	0,08	0,14
140	110	0,025	0,05	0,08	0,14
120	95	0,02	0,04	0,07	0,13
140	110	0,03	0,05	0,08	0,14
80	65	0,015	0,035	0,07	0,10
110	90	0,015	0,04	0,06	0,12
100	80	0,015	0,04	0,06	0,12
100	80	0,015	0,04	0,06	0,12
60	50	0,013	0,035	0,05	0,08
80	65	0,013	0,035	0,05	0,08
180	145	0,03	0,07	0,10	0,15
160	130	0,025	0,06	0,09	0,14
150	120	0,02	0,06	0,09	0,14
120	95	0,02	0,06	0,09	0,14
300	240	0,03	0,06	0,10	0,15
1000	800	0,03	0,06	0,10	0,15
250	200	0,025	0,05	0,09	0,14
300	240	0,025	0,05	0,09	0,14
250	200	0,03	0,06	0,10	0,15
350	280	0,025	0,05	0,10	0,15
400	320	0,04	0,08	0,15	0,20
70	55	0,015	0,03	0,05	0,09
40	30	0,01	0,03	0,05	0,09
30	25	0,01	0,03	0,05	0,09
20	15	0,01	0,03	0,05	0,09

Die angegebenen Schnittwerte sind Startwerte und müssen auf die vorhandenen Bedingungen abgestimmt werden.
 The cutting data indicated are starting values and must be adjusted to the prevailing conditions.

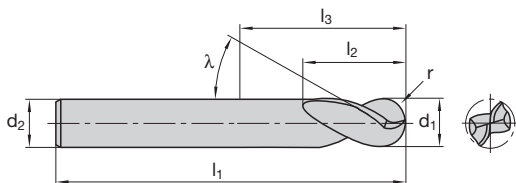

Katalog-Nr. Cat.-No.							1418C			
P										■
M										■
K										■
N										□
S										
H										
O										
d ₁	l ₂	l ₁	l ₃	d ₂	r	z	Ident No.		LMT-Code	
lang long										
3	7	57	21	6	1,5	2	1122569		EM-N 3x7/21 2BA	
4	8	57	21	6	2	2	1122582		EM-N 4x8/21 2BA	
5	10	57	21	6	2,5	2	1122594		EM-N 5x10/21 2BA	
6	10	57	21	6	3	2	1122606		EM-N 6x10/21 2BA	
8	16	63	27	8	4	2	1122618		EM-N 8x16/27 2BA	
10	19	72	32	10	5	2	1122631		EM-N 10x19/32 2BA	
12	22	83	38	12	6	2	1122643		EM-N 12x22/38 2BA	
14	22	83	38	14	7	2	1122656		EM-N 14x22/38 2BA	
16	26	92	44	16	8	2	1122668		EM-N 16x26/44 2BA	
18	26	92	44	18	9	2	1122680		EM-N 18x26/44 2BA	
20	32	104	54	20	10	2	1122692		EM-N 20x32/54 2BA	

Schnittwertempfehlungen ab Seite 138
Cutting data recommendations starting page 138

■ = Hauptanwendung First choice
□ = Nebenanwendung Second choice

Typ N
Kugel-Kopierfräser zur universellen Anwendung
Universal ball nose end mills

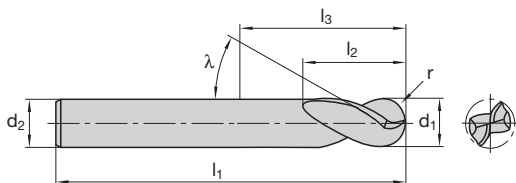

Katalog-Nr. Cat.-No.							1417C		
P							■		
M							■		
K							■		
N							□		
S									
H									
O									
d ₁	l ₂	l ₁	l ₃	d ₂	r	z	Ident No.	LMT-Code	
lang long									
3	7	57	21	6	1,5	2	1331040	EM-N 3x7/21 2BB	
4	8	57	21	6	2	2	1331029	EM-N 4x8/21 2BB	
5	10	57	21	6	2,5	2	1331030	EM-N 5x10/21 2BB	
6	10	57	21	6	3	2	1331031	EM-N 6x10/21 2BB	
8	16	63	27	8	4	2	1331032	EM-N 8x16/27 2BB	
10	19	72	32	10	5	2	1331033	EM-N 10x19/32 2BB	
12	22	83	38	12	6	2	1331034	EM-N 12x22/38 2BB	
14	22	83	38	14	7	2	1331035	EM-N 14x22/38 2BB	
16	26	92	44	16	8	2	1331036	EM-N 16x26/44 2BB	
18	26	92	44	18	9	2	1331039	EM-N 18x26/44 2BB	
20	32	104	54	20	10	2	1331038	EM-N 20x32/54 2BB	

Schnittwertempfehlungen ab Seite 138
 Cutting data recommendations starting page 138

■ = Hauptanwendung First choice
 □ = Nebenanwendung Second choice

Schnittwertempfehlungen für Typ N, universale Schafffräser
Cutting data recommendations for type N, universal end mills

				DIN Bezeichnung Alt DIN Description Old	R_m/UTS (N/mm²)	DIN Bezeichnung Neu DIN Description New
	Werkstoff	Material	Werkstoff-Nr. Material No.			
P	Unlegierter Baustahl + Automatenstahl	Plain carbon steel + free cutting steel	1.0570	St52-3	-700	S355J2G3
			1.1730	C45	-800	C45U
			1.0715	9SMn28	-700	11SMn30
			1.1191 1.7219	Ck45 26CrMo4	500-950	C45E 26CrMo4-2
	Vergütungsstahl, mittelfest	Heat-treatment steel, medium strength	1.7225	42CrMo4	500-950	42CrMo4
	Stahlguss	Cast steel	1.8159	51CrV4		51CrV4
	Einsatzstahl	Case hardening steel	1.0416	GS40	-950	GS40
	Rost- und säurebe- ständiger Stahl, ferritisch, martensitisch	Stainless steel, ferritic, martensitic	1.7131	16MnCr5	-950	16MnCr5
			1.4006	X10Cr13	500-950	X12Cr13
			1.4104 1.4122	X12CrMoS17 X35CrMo17		X14CrMoS17 X39CrMo17-1
	Vergütungsstahl, hochfest	Heat-treatment steel, high strength	1.7225	42CrMo4	950-1400	42CrMo4
	Nitrierstahl, vergütet	Nitriding steel, heat treated	1.6580	30CrNiMo8		30CrNiMo8
			1.8504	34CrAl6	950-1400	34CrAl6
	Werkzeugstahl	Tool steel	1.2344	X40CrMoV5.1	-900	X40CrMoV5-1
			1.2343	X38CrMoV5 1	950-1400	X37CrMoV5-1
			1.2379	X155CrVMo12 1	-950	X153CrMoV12-1
			1.2358	60CrMoV18-5	850-1000	60CrMoV18-5
1.2080			X210Cr12	950-1400	X210Cr12	
1.2714			55NiCrMoV7	1100-1350	55NiCrMoV7	
1.2311			40CrMnMo7	-1100	40CrMnMo7	
1.2312			40CrMnNiMoS8.6	-1150	40CrMnNiMoS8-6	
1.2316			X38CrMo16	-1100	X38CrMo16	
1.2738			45CrMnNiMo8.6.4	950-1150	45CrMnNiMo8-6-4	
M	Rost- und säurebe- ständiger Stahl, austenitisch	Stainless steel, austenitic	1.4301	X2CrNiMo17-12-2	500-950	X5CrNiMo18-10
			1.4404	X6CrNiMoTi17-12-2		X2CrNiMo17-12-2
			1.4571	X10CrNiMoTi18		X10CrNiMoTi18
	Rost- und säurebe- ständiger Stahl, martensitisch aushärtbar	Stainless steel, martensitic steel	1.2709	X3NiCoMoTi18-9-5	800-1000	X3NiCoMoTi18-9-5
		1.4542	X5CrNiCuNb16-4		X5CrNiCuNb16-4	
		1.4568	X7CrNiAl17-7		X7CrNiAl17-7	
K	Grauguss	Grey cast iron	0.6025	GG25	100-400 (120-260 HB)	EN-GJ1-250
	Legierter Grauguss	Alloyed grey cast iron	0.6678	GGL-NiCr35 2	150-250 (160-230 HB)	EN-GJLA-XNiCr35-2
	Sphäroguss	Nodular cast iron	0.7060 0.7070	GGG60 GGG70L	400-800 (120-310 HB)	EN-GJS-600-3 EN-GJS-700-2U
	Temperguss	Malleable cast iron	0.8155	GTS55	350-700 (150-280 HB)	EN-GJMB-550-4
N	Aluminium-Legierungen, kurzspanend	Aluminium alloys, short chipping	3.2581	G-AlSi12	-400	G-IGK-AlSi12
	Aluminium-Legierungen, langspanend	Aluminium alloys, long chipping	3.3535	AlMg3	-550	AlMg3
	Kupfer-Legierungen, kurzspanend	Copper alloys, short chipping	3.4365	AlZnMgCu1,5		AlZnMgCu1,5
	Kupfer-Legierungen, langspanend	Copper alloys, long chipping	2.0402	MS58	-500	CuZn40Pb2
	Thermoplaste	Thermoplastics	2.0320 2.0975	MS63 CuAl10Ni	300-500	CuZn37 CuAl10Fe5Ni5-C
	Duroplaste	Duroplastics		PVC	40-70	PVC
	Graphit	Graphite		Bakelit, Melamin	20-40	Bakelit, Melamin
S	Titan-Legierungen, mittelfest	Titanium alloys, medium strength	3.7115 3.7164	TiAl5Sn2,5 TiAl6V4	-950	TiAl5Sn2-5 Ti6AlV4
	Titan-Legierungen, hochfest	Titanium alloys, high strength	3.7174	TiAl6Sn2	900-1400	TiAl6V6Sn2
	Nickelbasis-Legierungen, mittelfest	Nickel based alloys, medium strength	2.4670	NiCr12Al6MoNb	-950	NiCr12Al6MoNb
	Nickelbasis-Legierungen, hochwarmfest	Heat resistant nickel based alloys, high strength	2.4668	NiCr19Fe19NbMo	900-1400	Inconel 718 NiCr19Fe19Nb5Mo3

Bitte beachten Sie die Werkstoffempfehlung auf der jeweiligen Produktseite.
Please take notice of the material recommendations at each catalogpage of the product.

Hinweise zur Ermittlung des effektiven Schneidendurchmessers bei Kugelfräsern auf Seite 99.
Hints for calculation of the effective cutting diameter of ball nose end mills on page 99.

Schnittgeschwindigkeit Cutting speed v_c (m/min)		Fräserdurchmesser Cutting diameter (mm)			
		Vorschub pro Zahn Feed per tooth f_z (mm/z.)			
Hartmetall Carbide		Ø 2-4	Ø 5-10	Ø 11-16	Ø >16
beschichtet coated	unbeschichtet uncoated				
230	185	0,03	0,06	0,09	0,15
200	160	0,025	0,06	0,08	0,14
140	110	0,025	0,05	0,08	0,14
120	95	0,02	0,04	0,07	0,13
140	110	0,03	0,05	0,08	0,14
80	65	0,015	0,035	0,07	0,10
110	90	0,015	0,04	0,06	0,12
100	80	0,015	0,04	0,06	0,12
100	80	0,015	0,04	0,06	0,12
60	50	0,013	0,035	0,05	0,08
80	65	0,013	0,035	0,05	0,08
180	145	0,03	0,07	0,10	0,15
160	130	0,025	0,06	0,09	0,14
150	120	0,02	0,06	0,09	0,14
120	95	0,02	0,06	0,09	0,14
300	240	0,03	0,06	0,10	0,15
1000	800	0,03	0,06	0,10	0,15
250	200	0,025	0,05	0,09	0,14
300	240	0,025	0,05	0,09	0,14
250	200	0,03	0,06	0,10	0,15
350	280	0,025	0,05	0,10	0,15
400	320	0,04	0,08	0,15	0,20
70	55	0,015	0,03	0,05	0,09
40	30	0,01	0,03	0,05	0,09
30	25	0,01	0,03	0,05	0,09
20	15	0,01	0,03	0,05	0,09

Die angegebenen Schnittwerte sind Startwerte und müssen auf die vorhandenen Bedingungen abgestimmt werden.
 The cutting data indicated are starting values and must be adjusted to the prevailing conditions.

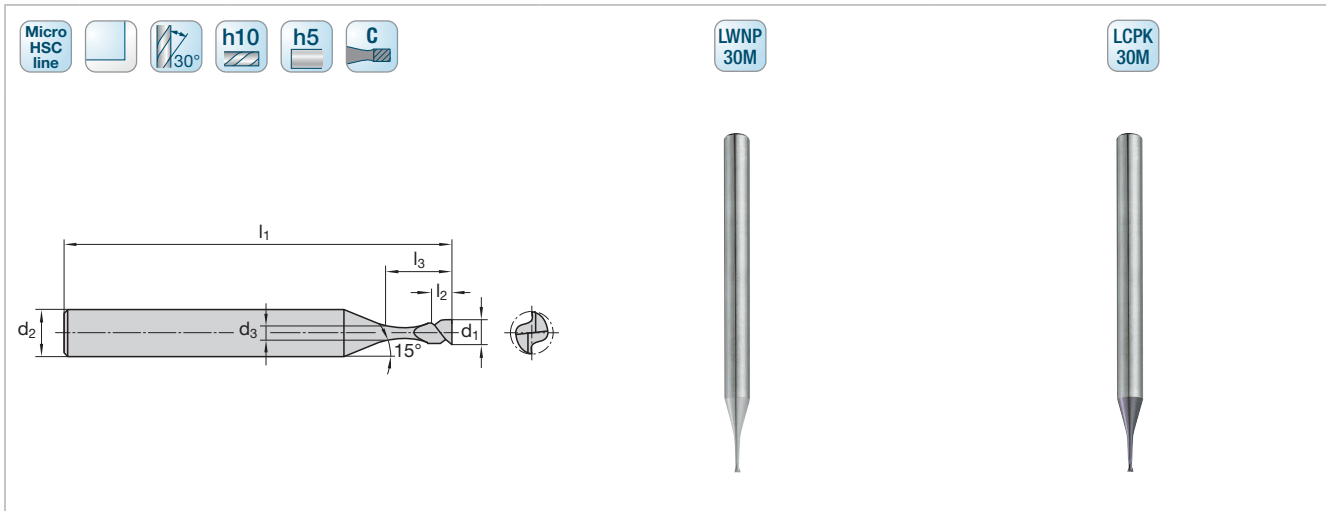

Katalog-Nr. Cat.-No.								1415		1415C	
P								<input type="checkbox"/>			<input checked="" type="checkbox"/>
M											
K											<input type="checkbox"/>
N								<input checked="" type="checkbox"/>			
S											
H											
O											
d ₁	l ₂	l ₁	l ₃	d ₂	d ₃	z		Ident No.	LMT-Code	Ident No.	LMT-Code
0,2	0,2	40	0,6	3	0,2	2	XS	9120774	EM-M 002x002/0006 SC ...	1302000	EM-M 002x002/0006 SC ...
0,3	0,3	40	0,9	3	0,3	2	XS	9120801	EM-M 003x003/0009 SC ...	1302001	EM-M 003x003/0009 SC ...
0,4	0,4	40	1,2	3	0,4	2	XS	9120802	EM-M 004x004/0012 SC ...	1121872	EM-M 004x004/0012 SC ...
0,5	0,5	40	1,5	3	0,5	2	XS	9120803	EM-M 005x005/0015 SC ...	1121873	EM-M 005x005/0015 SC ...
0,6	0,6	40	1,8	3	0,6	2	XS	9120804	EM-M 006x006/0018 SC ...	1121874	EM-M 006x006/0018 SC ...
0,8	0,8	40	2,4	3	0,8	2	XS	9120806	EM-M 008x008/0024 SC ...	1121875	EM-M 008x008/0024 SC ...
1	1	40	3	4	1	2	XS	9120807	EM-M 010x010/0030 SC ...	1121876	EM-M 010x010/0030 SC ...
1,2	1,2	40	3,6	4	1,2	2	XS	9120808	EM-M 012x012/0036 SC ...	1121877	EM-M 012x012/0036 SC ...
1,4	1,4	40	4,2	4	1,4	2	XS	9120809	EM-M 014x014/0042 SC ...	1121878	EM-M 014x014/0042 SC ...
1,5	1,5	40	4,5	4	1,5	2	XS	9120810	EM-M 015x015/0045 SC ...	1121879	EM-M 015x015/0045 SC ...
1,6	1,6	40	4,8	4	1,6	2	XS	9120812	EM-M 016x016/0048 SC ...	1121880	EM-M 016x016/0048 SC ...
1,8	1,8	40	5,4	4	1,8	2	XS	9120813	EM-M 018x018/0054 SC ...	1121881	EM-M 018x018/0054 SC ...
2	2	40	6	4	2	2	XS	9120814	EM-M 020x020/0060 SC ...	1121882	EM-M 020x020/0060 SC ...
0,2	0,2	50	1	3	0,2	2	S	9120818	EM-M 002x002/0010 SC ...	1302002	EM-M 002x002/0010 SC ...
0,3	0,3	50	1,5	3	0,3	2	S	9120820	EM-M 003x003/0015 SC ...	1302003	EM-M 003x003/0015 SC ...
0,4	0,4	50	2	3	0,4	2	S	9120824	EM-M 004x004/0020 SC ...	1302004	EM-M 004x004/0020 SC ...
0,5	0,5	50	2,5	3	0,5	2	S	9120827	EM-M 005x005/0025 SC ...	1331056	EM-M 005x005/0025 SC ...
0,6	0,6	50	3	3	0,6	2	S	9120828	EM-M 006x006/0030 SC ...	1302005	EM-M 006x006/0030 SC ...
0,8	0,8	50	4	3	0,8	2	S	9120839	EM-M 008x008/0040 SC ...	1302006	EM-M 008x008/0040 SC ...
1	1	50	5	4	1	2	S	9120840	EM-M 010x010/0050 SC ...	1331057	EM-M 010x010/0050 SC ...
1,2	1,2	50	6	4	1,2	2	S	9120841	EM-M 012x012/0060 SC ...	1302007	EM-M 012x012/0060 SC ...
1,4	1,4	50	7	4	1,4	2	S	9120843	EM-M 014x014/0070 SC ...	1302008	EM-M 014x014/0070 SC ...
1,5	1,5	50	7,5	4	1,5	2	S	9120844	EM-M 015x015/0075 SC ...	1331041	EM-M 015x015/0075 SC ...
1,6	1,6	50	8	4	1,6	2	S	9120845	EM-M 016x016/0080 SC ...	1302009	EM-M 016x016/0080 SC ...
1,8	1,8	50	9	4	1,8	2	S	9120846	EM-M 018x018/0090 SC ...	1302010	EM-M 018x018/0090 SC ...
0,4	0,4	50	4	3	0,4	2	XL	9120853	EM-M 004x004/0040 SC ...	1302013	EM-M 004x004/0040 SC ...
0,5	0,5	50	5	3	0,5	2	XL	9120854	EM-M 005x005/0050 SC ...	1331043	EM-M 005x005/0050 SC ...
0,6	0,6	50	6	3	0,6	2	XL	9120856	EM-M 006x006/0060 SC ...	1302014	EM-M 006x006/0060 SC ...
0,8	0,8	50	8	3	0,8	2	XL	9120857	EM-M 008x008/0080 SC ...	1302015	EM-M 008x008/0080 SC ...
1	1	50	10	4	1	2	XL	9120858	EM-M 010x010/0100 SC ...	1331044	EM-M 010x010/0100 SC ...
1,2	1,2	50	12	4	1,2	2	XL	9120859	EM-M 012x012/0120 SC ...	1302016	EM-M 012x012/0120 SC ...

Schnittwertempfehlungen ab Seite 154
 Cutting data recommendations starting page 154

■ = Hauptanwendung First choice
 □ = Nebenanwendung Second choice



Katalog-Nr. Cat.-No.	1415	1415C
P	□	■
M		
K		□
N	■	
S		
H		
O		
d ₁ l ₂ l ₁ l ₃ d ₂ d ₃ z	Ident No. LMT-Code	Ident No. LMT-Code
1,5 1,5 50 15 4 1,5 2 XL	9120863 EM-M 015x015/0150 SC ...	1331045 EM-M 015x015/0150 SC ...

Schnittwertempfehlungen ab Seite 154
 Cutting data recommendations starting page 154

■ = Hauptanwendung First choice
 □ = Nebenanwendung Second choice



Uhrengehäuse Watchcase

Werkstoff Material:
 Messing Brass

Werkzeug Tool:
 Kat.-Nr. Cat.-No. 1415, LWNP30M
 gerade straight corner
 Ø 1,0 mm

Branche Branch:
 Maschinenbau inkl. Dekolletage
 General machining incl. decolletage

Vorschubgeschwindigkeit Feed rate:
 $V_f = 1000 \text{ mm/min}$

Drehzahl Speed:
 $n = 25\,000 \text{ min}^{-1}$ ¹⁾
 $a_p = 200 \text{ }\mu\text{m}$
 $a_e = 250 \text{ }\mu\text{m}$

Bearbeitungszeit Cutting time:
 15 min

¹⁾ Maximale Spindeldrehzahl der jeweiligen Maschine.
 Max. spindle speed of the particular machine.

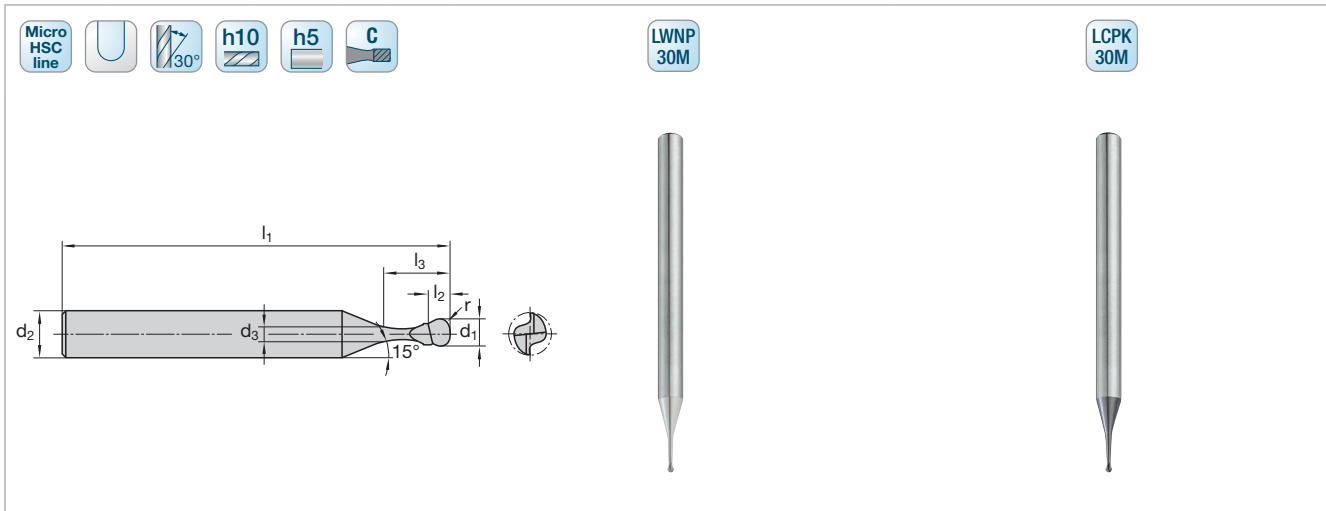

Katalog-Nr. Cat.-No.	1419	1419C
P	□	■
M		
K		□
N	■	
S		
H		
O		

d ₁	l ₂	l ₁	l ₃	d ₂	d ₃	z	r		Ident No.	LMT-Code	Ident No.	LMT-Code
0,2	0,2	40	0,6	3	0,2	2	0,10	XS	9120873	EM-M 002x002/0006 BN 0010 ...	1302020	EM-M 002x002/0006 BN 0010 ...
0,3	0,3	40	0,9	3	0,3	2	0,15	XS	9120874	EM-M 003x003/0009 BN 0015 ...	1302021	EM-M 003x003/0009 BN 0015 ...
0,4	0,4	40	1,2	3	0,4	2	0,20	XS	9120876	EM-M 004x004/0012 BN 0020 ...	1121883	EM-M 004x004/0012 BN 0020 ...
0,5	0,5	40	1,5	3	0,5	2	0,25	XS	9120878	EM-M 005x005/0015 BN 0025 ...	1121884	EM-M 005x005/0015 BN 0025 ...
0,6	0,6	40	1,8	3	0,6	2	0,30	XS	9120879	EM-M 006x006/0018 BN 0030 ...	1121885	EM-M 006x006/0018 BN 0030 ...
0,8	0,8	40	2,4	3	0,8	2	0,40	XS	9120880	EM-M 008x008/0024 BN 0040 ...	1121886	EM-M 008x008/0024 BN 0040 ...
1	1	40	3	4	1	2	0,50	XS	9120882	EM-M 010x010/0030 BN 0050 ...	1121887	EM-M 010x010/0030 BN 0050 ...
1,2	1,2	40	3,6	4	1,2	2	0,60	XS	9120883	EM-M 012x012/0036 BN 0060 ...	1121888	EM-M 012x012/0036 BN 0060 ...
1,4	1,4	40	4,2	4	1,4	2	0,70	XS	9120884	EM-M 014x014/0042 BN 0070 ...	1121890	EM-M 014x014/0042 BN 0070 ...
1,5	1,5	40	4,5	4	1,5	2	0,75	XS	9120885	EM-M 015x015/0045 BN 0075 ...	1121891	EM-M 015x015/0045 BN 0075 ...
1,6	1,6	40	4,8	4	1,6	2	0,80	XS	9120887	EM-M 016x016/0048 BN 0080 ...	1121892	EM-M 016x016/0048 BN 0080 ...
1,8	1,8	40	5,4	4	1,8	2	0,90	XS	9120888	EM-M 018x018/0054 BN 0090 ...	1121893	EM-M 018x018/0054 BN 0090 ...
2	2	40	6	4	2	2	1	XS	9120890	EM-M 020x020/0060 BN 0100 ...	1121894	EM-M 020x020/0060 BN 0100 ...
0,3	0,3	50	1,5	3	0,3	2	0,15	S	9120899	EM-M 003x003/0015 BN 0015 ...	1302023	EM-M 003x003/0015 BN 0015 ...
0,4	0,4	50	2	3	0,4	2	0,20	S	9120901	EM-M 004x004/0020 BN 0020 ...	1302024	EM-M 004x004/0020 BN 0020 ...
0,5	0,5	50	2,5	3	0,5	2	0,25	S	9120904	EM-M 005x005/0025 BN 0025 ...	1331047	EM-M 005x005/0025 BN 0025 ...
0,6	0,6	50	3	3	0,6	2	0,30	S	9120930	EM-M 006x006/0030 BN 0030 ...	1302025	EM-M 006x006/0030 BN 0030 ...
0,8	0,8	50	4	3	0,8	2	0,40	S	9120931	EM-M 008x008/0040 BN 0040 ...	1302026	EM-M 008x008/0040 BN 0040 ...
1	1	50	5	4	1	2	0,50	S	9120932	EM-M 010x010/0050 BN 0050 ...	1331048	EM-M 010x010/0050 BN 0050 ...
1,2	1,2	50	6	4	1,2	2	0,60	S	9120933	EM-M 012x012/0060 BN 0060 ...	1302027	EM-M 012x012/0060 BN 0060 ...
1,4	1,4	50	7	4	1,4	2	0,70	S	9120934	EM-M 014x014/0070 BN 0070 ...	1302028	EM-M 014x014/0070 BN 0070 ...
1,5	1,5	50	7,5	4	1,5	2	0,75	S	9120935	EM-M 015x015/0075 BN 0075 ...	1331049	EM-M 015x015/0075 BN 0075 ...
1,8	1,8	50	9	4	1,8	2	0,90	S	9120937	EM-M 018x018/0090 BN 0090 ...	1302030	EM-M 018x018/0090 BN 0090 ...
0,2	0,2	50	2	3	0,2	2	0,10	XL	9120941	EM-M 002x002/0020 BN 0010 ...	1302031	EM-M 002x002/0020 BN 0010 ...
0,3	0,3	50	3	3	0,3	2	0,15	XL	9120942	EM-M 003x003/0030 BN 0015 ...	1302032	EM-M 003x003/0030 BN 0015 ...
0,4	0,4	50	4	3	0,4	2	0,20	XL	9120943	EM-M 004x004/0040 BN 0020 ...	1302033	EM-M 004x004/0040 BN 0020 ...
0,5	0,5	50	5	3	0,5	2	0,25	XL	9120945	EM-M 005x005/0050 BN 0025 ...	1331051	EM-M 005x005/0050 BN 0025 ...
0,6	0,6	50	6	3	0,6	2	0,30	XL	9120946	EM-M 006x006/0060 BN 0030 ...	1302034	EM-M 006x006/0060 BN 0030 ...
0,8	0,8	50	8	3	0,8	2	0,40	XL	9120947	EM-M 008x008/0080 BN 0040 ...	1302035	EM-M 008x008/0080 BN 0040 ...
1	1	50	10	4	1	2	0,50	XL	9120949	EM-M 010x010/0100 BN 0050 ...	1331052	EM-M 010x010/0100 BN 0050 ...
1,2	1,2	50	12	4	1,2	2	0,60	XL	9120950	EM-M 012x012/0120 BN 0060 ...	1302036	EM-M 012x012/0120 BN 0060 ...

Schnittwertempfehlungen ab Seite 154 ■ = Hauptanwendung First choice
 Cutting data recommendations starting page 154 □ = Nebenanwendung Second choice



Katalog-Nr. Cat.-No.										1419		1419C	
P										□		■	
M													
K												□	
N										■			
S													
H													
O													
d ₁	l ₂	l ₁	l ₃	d ₂	d ₃	z	r		Ident No.	LMT-Code	Ident No.	LMT-Code	
1,4	1,4	50	14	4	1,4	2	0,70	XL	9120951	EM-M 014x014/0140 BN 0070 ...	1302037	EM-M 014x014/0140 BN 0070 ...	
1,5	1,5	50	15	4	1,5	2	0,75	XL	9120952	EM-M 015x015/0150 BN 0075 ...	1331053	EM-M 015x015/0150 BN 0075 ...	
1,6	1,6	55	16	4	1,6	2	0,80	XL	9120953	EM-M 016x016/0160 BN 0080 ...	1302038	EM-M 016x016/0160 BN 0080 ...	
1,8	1,8	55	18	4	1,8	2	0,90	XL	9120954	EM-M 018x018/0180 BN 0090 ...	1302039	EM-M 018x018/0180 BN 0090 ...	

Fräsen mit Schlitzzähnen aus Vollhartmetall
Milling with solid carbide end mills

Schnittwertempfehlungen ab Seite 154 ■ = Hauptanwendung First choice
 Cutting data recommendations starting page 154 □ = Nebenanwendung Second choice

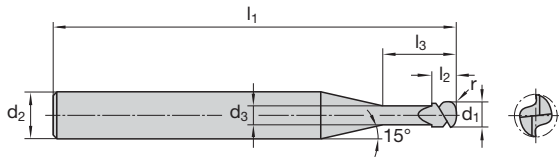

Katalog-Nr. Cat.-No.		1465C									
P		<input type="checkbox"/>									
M											
K											
N											
S											
H		<input checked="" type="checkbox"/>									
O											
d ₁	l ₂	l ₁	l ₃	d ₂	d ₃	z	r		Ident No.	LMT-Code	
0,2	0,3	50	0,5	4	0,17	2	0,02	XS	7114561	EM-M 002x003/0005 CR 0002 ...	
2	3	50	6	4	1,90	2	0,20	XS	7114590	EM-M 020x030/0060 CR 0020 ...	
3	4,5	50	8	6	2,80	2	0,30	XS	7114600	EM-M 030x045/0080 CR 0030 ...	
0,2	0,3	50	1	4	0,17	2	0,02	S	7114562	EM-M 002x003/0010 CR 0002 ...	
0,3	0,4	50	1	4	0,27	2	0,03	S	7114564	EM-M 003x004/0010 CR 0003 ...	
0,4	0,6	50	2	4	0,37	2	0,03	S	7114566	EM-M 004x006/0020 CR 0003 ...	
0,5	0,7	50	2	4	0,45	2	0,05	S	7114569	EM-M 005x007/0020 CR 0005 ...	
0,8	1,2	50	4	4	0,75	2	0,08	S	7114573	EM-M 008x012/0040 CR 0008 ...	
1,5	2,3	50	6	4	1,40	2	0,15	S	7114585	EM-M 015x023/0060 CR 0015 ...	
2	3	50	8	4	1,90	2	0,20	S	7114591	EM-M 020x030/0080 CR 0020 ...	
2	3	50	10	4	1,90	2	0,20	S	7114592	EM-M 020x030/0100 CR 0020 ...	
2,5	3,7	50	8	4	2,40	2	0,30	S	7114596	EM-M 025x037/0080 CR 0030 ...	
2,5	3,7	50	12	4	2,40	2	0,30	S	7114597	EM-M 025x037/0120 CR 0030 ...	
3	4,5	50	10	6	2,80	2	0,30	S	7114601	EM-M 030x045/0100 CR 0030 ...	
3	4,5	50	12	6	2,80	2	0,30	S	7114602	EM-M 030x045/0120 CR 0030 ...	
0,2	0,3	50	1,5	4	0,17	2	0,02	L	7114563	EM-M 002x003/0015 CR 0002 ...	
0,3	0,4	50	2	4	0,27	2	0,03	L	7114565	EM-M 003x004/0020 CR 0003 ...	
0,4	0,6	50	3	4	0,37	2	0,03	L	7114567	EM-M 004x006/0030 CR 0003 ...	
0,5	0,7	50	4	4	0,45	2	0,05	L	7114570	EM-M 005x007/0040 CR 0005 ...	
0,8	1,2	50	6	4	0,75	2	0,08	L	7114574	EM-M 008x012/0060 CR 0008 ...	
1	1,5	50	6	4	0,90	2	0,10	L	7114578	EM-M 010x015/0060 CR 0010 ...	
1	1,5	50	8	4	0,90	2	0,10	L	7114579	EM-M 010x015/0080 CR 0010 ...	
1,2	1,8	50	8	4	1,10	2	0,10	L	7114583	EM-M 012x018/0080 CR 0010 ...	
1,5	2,3	50	8	4	1,40	2	0,15	L	7114586	EM-M 015x023/0080 CR 0015 ...	
1,5	2,3	50	10	4	1,40	2	0,15	L	7114587	EM-M 015x023/0100 CR 0015 ...	
1,5	2,3	50	12	4	1,40	2	0,15	L	7114588	EM-M 015x023/0120 CR 0015 ...	
2	3	50	12	4	1,90	2	0,20	L	7114593	EM-M 020x030/0120 CR 0020 ...	
2	3	50	16	4	1,90	2	0,20	L	7114594	EM-M 020x030/0160 CR 0020 ...	
2,5	3,7	50	16	4	2,40	2	0,30	L	7114598	EM-M 025x037/0160 CR 0030 ...	
2,5	3,7	60	20	4	2,40	2	0,30	L	7114599	EM-M 025x037/0200 CR 0030 ...	
3	4,5	60	16	6	2,80	2	0,30	L	7114603	EM-M 030x045/0160 CR 0030 ...	
3	4,5	60	20	6	2,80	2	0,30	L	7114604	EM-M 030x045/0200 CR 0030 ...	

Schnittwertempfehlungen ab Seite 154
 Cutting data recommendations starting page 154

■ = Hauptanwendung First choice
 □ = Nebenanwendung Second choice



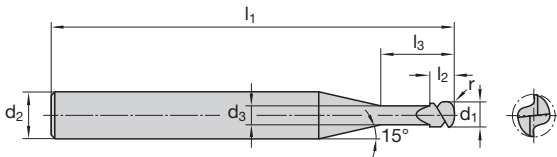

Katalog-Nr. Cat.-No.		1465C									
P		☐									
M											
K											
N											
S											
H		■									
O											
d ₁	l ₂	l ₁	l ₃	d ₂	d ₃	z	r		Ident No.	LMT-Code	
0,4	0,6	50	4	4	0,37	2	0,03	XL	7114568	EM-M 004x006/0040 CR 0003 ...	
0,5	0,7	50	6	4	0,45	2	0,05	XL	7114571	EM-M 005x007/0060 CR 0005 ...	
0,5	0,7	50	8	4	0,45	2	0,05	XL	7114572	EM-M 005x007/0080 CR 0005 ...	
0,8	1,2	50	8	4	0,75	2	0,08	XL	7114575	EM-M 008x012/0080 CR 0008 ...	
0,8	1,2	50	10	4	0,75	2	0,08	XL	7114576	EM-M 008x012/0100 CR 0008 ...	
0,8	1,2	50	12	4	0,75	2	0,08	XL	7114577	EM-M 008x012/0120 CR 0008 ...	
1	1,5	50	10	4	0,90	2	0,10	XL	7114580	EM-M 010x015/0100 CR 0010 ...	
1	1,5	50	12	4	0,90	2	0,10	XL	7114581	EM-M 010x015/0120 CR 0010 ...	
1	1,5	50	16	4	0,90	2	0,10	XL	7114582	EM-M 010x015/0160 CR 0010 ...	
1,2	1,8	50	12	4	1,10	2	0,10	XL	7114584	EM-M 012x018/0120 CR 0010 ...	
1,5	2,3	50	16	4	1,40	2	0,15	XL	7114589	EM-M 015x023/0160 CR 0015 ...	
2	3	60	20	4	1,90	2	0,20	XL	7114595	EM-M 020x030/0200 CR 0020 ...	

Schnittwertempfehlungen ab Seite 154
 Cutting data recommendations starting page 154

■ = Hauptanwendung First choice
 ☐ = Nebenanwendung Second choice

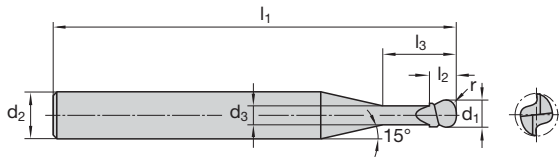

Katalog-Nr. Cat.-No.		1466C								
P		<input type="checkbox"/>								
M										
K										
N										
S										
H		<input checked="" type="checkbox"/>								
O										
d ₁	l ₂	l ₁	l ₃	d ₂	d ₃	z	r		Ident No.	LMT-Code
0,2	0,2	50	0,5	4	0,17	2	0,10	XS	7114520	EM-M 002x002/0005 BN 0010 ...
0,4	0,4	50	1	4	0,37	2	0,20	XS	7114525	EM-M 004x004/0010 BN 0020 ...
0,8	0,6	50	2	4	0,75	2	0,40	XS	7114534	EM-M 008x006/0020 BN 0040 ...
1	0,8	50	3	4	0,90	2	0,50	XS	7114539	EM-M 010x008/0030 BN 0050 ...
2	1,6	50	4	4	1,90	2	1	XS	7114551	EM-M 020x016/0040 BN 0100 ...
2	1,6	50	6	4	1,90	2	1	XS	7114552	EM-M 020x016/0060 BN 0100 ...
3	2,4	50	8	6	2,80	2	1,50	XS	7114557	EM-M 030x024/0080 BN 0150 ...
0,2	0,2	50	1	4	0,17	2	0,10	S	7114521	EM-M 002x002/0010 BN 0010 ...
0,3	0,3	50	1	4	0,27	2	0,15	S	7114523	EM-M 003x003/0010 BN 0015 ...
0,4	0,4	50	2	4	0,37	2	0,20	S	7114526	EM-M 004x004/0020 BN 0020 ...
0,5	0,4	50	2	4	0,45	2	0,25	S	7114529	EM-M 005x004/0020 BN 0025 ...
0,8	0,6	50	4	4	0,75	2	0,40	S	7114535	EM-M 008x006/0040 BN 0040 ...
1	0,8	50	4	4	0,90	2	0,50	S	7114540	EM-M 010x008/0040 BN 0050 ...
2	1,6	50	8	4	1,90	2	1	S	7114553	EM-M 020x016/0080 BN 0100 ...
2	1,6	50	10	4	1,90	2	1	S	7114554	EM-M 020x016/0100 BN 0100 ...
3	2,4	50	10	6	2,80	2	1,50	S	7114558	EM-M 030x024/0100 BN 0150 ...
0,2	0,2	50	1,5	4	0,17	2	0,10	L	7114522	EM-M 002x002/0015 BN 0010 ...
0,3	0,3	50	2	4	0,27	2	0,15	L	7114524	EM-M 003x003/0020 BN 0015 ...
0,4	0,4	50	3	4	0,37	2	0,20	L	7114527	EM-M 004x004/0030 BN 0020 ...
0,5	0,4	50	3	4	0,45	2	0,25	L	7114530	EM-M 005x004/0030 BN 0025 ...
0,5	0,4	50	4	4	0,45	2	0,25	L	7114531	EM-M 005x004/0040 BN 0025 ...
0,8	0,6	50	6	4	0,75	2	0,40	L	7114536	EM-M 008x006/0060 BN 0040 ...
1	0,8	50	6	4	0,90	2	0,50	L	7114541	EM-M 010x008/0060 BN 0050 ...
1	0,8	50	8	4	0,90	2	0,50	L	7114542	EM-M 010x008/0080 BN 0050 ...
1,2	1	50	8	4	1,10	2	0,60	L	7114546	EM-M 012x010/0080 BN 0060 ...
1,5	1,2	50	8	4	1,40	2	0,75	L	7114548	EM-M 015x012/0080 BN 0075 ...
1,5	1,2	50	12	4	1,40	2	0,75	L	7114549	EM-M 015x012/0120 BN 0075 ...
2	1,6	50	12	4	1,90	2	1	L	7114555	EM-M 020x016/0120 BN 0100 ...
2	1,6	50	16	4	1,90	2	1	L	7114556	EM-M 020x016/0160 BN 0100 ...
3	2,4	60	16	6	2,80	2	1,50	L	7114559	EM-M 030x024/0160 BN 0150 ...
3	2,4	60	20	6	2,80	2	1,50	L	7114560	EM-M 030x024/0200 BN 0150 ...

Schnittwertempfehlungen ab Seite 154
 Cutting data recommendations starting page 154

■ = Hauptanwendung First choice
 □ = Nebenanwendung Second choice



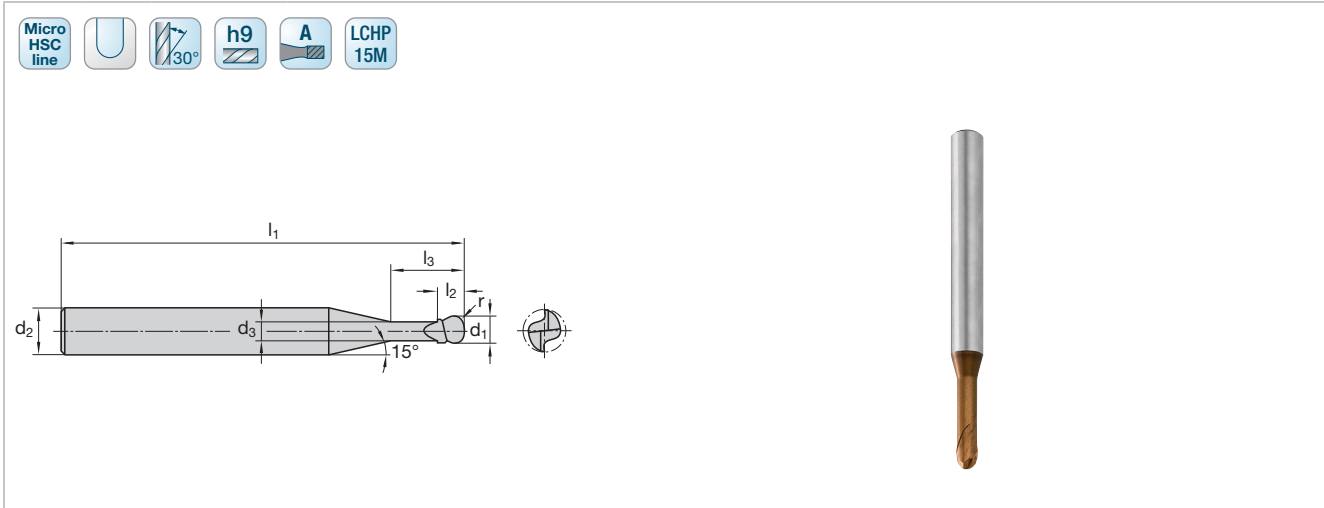

Katalog-Nr. Cat.-No.		1466C								
P		□								
M										
K										
N										
S										
H		■								
O										
d ₁	l ₂	l ₁	l ₃	d ₂	d ₃	z	r		Ident No.	LMT-Code
0,4	0,4	50	4	4	0,37	2	0,20	XL	7114528	EM-M 004x004/0040 BN 0020 ...
0,5	0,4	50	6	4	0,45	2	0,25	XL	7114532	EM-M 005x004/0060 BN 0025 ...
0,5	0,4	50	8	4	0,45	2	0,25	XL	7114533	EM-M 005x004/0080 BN 0025 ...
0,8	0,6	50	8	4	0,75	2	0,40	XL	7114537	EM-M 008x006/0080 BN 0040 ...
0,8	0,6	50	10	4	0,75	2	0,40	XL	7114538	EM-M 008x006/0100 BN 0040 ...
1	0,8	50	10	4	0,90	2	0,50	XL	7114543	EM-M 010x008/0100 BN 0050 ...
1	0,8	50	12	4	0,90	2	0,50	XL	7114544	EM-M 010x008/0120 BN 0050 ...
1	0,8	50	16	4	0,90	2	0,50	XL	7114545	EM-M 010x008/0160 BN 0050 ...
1,2	1	50	12	4	1,10	2	0,60	XL	7114547	EM-M 012x010/0120 BN 0060 ...
1,5	1,2	50	16	4	1,40	2	0,75	XL	7114550	EM-M 015x012/0160 BN 0075 ...

Schnittwertempfehlungen ab Seite 154
 Cutting data recommendations starting page 154

■ = Hauptanwendung First choice
 □ = Nebenanwendung Second choice

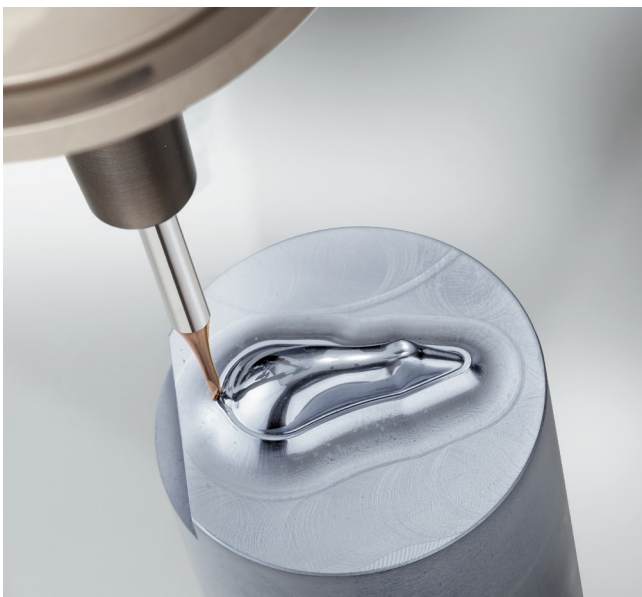

Prägestempel Forming punch

Werkstoff Material:
 S390, weichgeglüht annealed 300 HB

Werkzeug Tool:
 Kat.-Nr. Cat.-No. 1465C, LCHP15M
 Kugel Ballnose Ø 0,5 mm

Branche Branch:
 Gesenk- und Formenbau Mold and die

Vorschubgeschwindigkeit Feed rate:
 $V_f = 200 \text{ mm/min}$

Drehzahl Speed:
 $n = 30\,000 \text{ min}^{-1}$
 $a_p = 100 \text{ }\mu\text{m}$
 $a_e = 5 \text{ }\mu\text{m}$

Bearbeitungszeit Cutting time:
 100 min

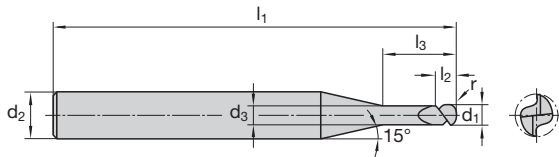

Katalog-Nr. Cat.-No.									1468C		
P											
M											
K											
N										■ 1)	
S											
H											
O											
d ₁	l ₂	l ₁	l ₃	d ₂	d ₃	z	r		Ident No.	LMT-Code	
1	3	40	4,0	4	1	2	0,15	S	7114613	EM-M 010x030/0040 CR 0015 ...	
1,5	4,5	40	6,5	4	1,5	2	0,15	S	7114614	EM-M 015x045/0065 CR 0015 ...	
2	6,5	40	8,5	4	2	2	0,15	S	7114615	EM-M 020x065/0085 CR 0015 ...	
2,5	6,5	40	8,5	4	2,5	2	0,20	S	7114616	EM-M 025x065/0085 CR 0020 ...	
3	9	50	11,0	6	3	2	0,20	S	7114617	EM-M 030x090/0110 CR 0020 ...	

1) Hauptsächlich für Graphit geeignet
 Mainly for graphite

Schnittwertempfehlungen ab Seite 154
 Cutting data recommendations starting page 154

■ = Hauptanwendung First choice
 □ = Nebenanwendung Second choice

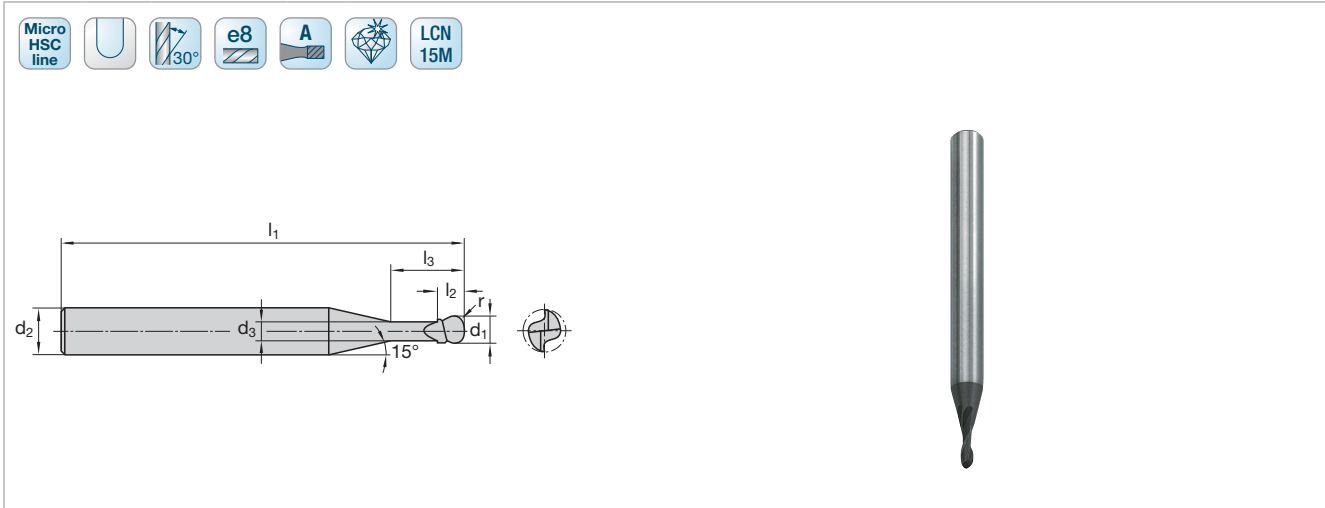

Katalog-Nr. Cat.-No.		1469C								
P										
M										
K										
N		■ 1)								
S										
H										
O										
d ₁	l ₂	l ₁	l ₃	d ₂	d ₃	z	r		Ident No.	LMT-Code
0,5	1	50	6	4	0,45	2	0,25	XL	7114605	EM-M 005x010/0060 BN 0025 ...
0,8	1,60	50	8	4	0,75	2	0,40	XL	7114606	EM-M 008x016/0080 BN 0040 ...
1	3	60	10	4	0,90	2	0,50	XL	7114607	EM-M 010x030/0100 BN 0050 ...
1,5	3	60	15	4	1,40	2	0,75	XL	7114608	EM-M 015x030/0150 BN 0075 ...
2	4	60	20	4	1,90	2	1	XL	7114609	EM-M 020x040/0200 BN 0100 ...
2,5	4	60	25	4	2,40	2	1,25	XL	7114610	EM-M 025x040/0250 BN 0125 ...
3	5	75	35	6	2,80	2	1,50	XL	7114611	EM-M 030x050/0350 BN 0150 ...
3	5	100	60	6	2,80	2	1,50	XL	7114612	EM-M 030x050/0600 BN 0150 ...

1) Hauptsächlich für Graphit geeignet
 Mainly for graphite

Schnittwertempfehlungen ab Seite 154
 Cutting data recommendations starting page 154

■ = Hauptanwendung First choice
 □ = Nebenanwendung Second choice



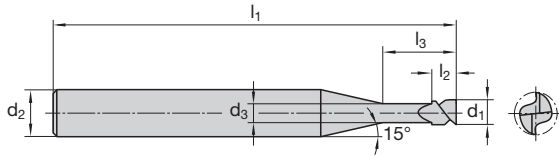

Katalog-Nr. Cat.-No.		1475C							
P									
M									■
K									
N									□
S									■
H									
O									
d ₁	l ₂	l ₁	l ₃	d ₂	d ₃	z		Ident No.	LMT-Code
2	3	50	6	4	1,90	2	XS	7114471	EM-M 020x030/0060 SC ...
3	4,5	50	8	6	2,80	2	XS	7114480	EM-M 030x045/0080 SC ...
0,3	0,4	50	1	4	0,27	2	S	7114450	EM-M 003x004/0010 SC ...
0,5	0,7	50	2	4	0,45	2	S	7114452	EM-M 005x007/0020 SC ...
0,8	1,2	50	4	4	0,75	2	S	7114456	EM-M 008x012/0040 SC ...
1,5	2,3	50	6	4	1,40	2	S	7114466	EM-M 015x023/0060 SC ...
2	3	50	8	4	1,90	2	S	7114472	EM-M 020x030/0080 SC ...
2,5	3,7	50	8	4	2,40	2	S	7114476	EM-M 025x037/0080 SC ...
2,5	3,7	50	12	4	2,40	2	S	7114477	EM-M 025x037/0120 SC ...
3	4,5	50	10	6	2,80	2	S	7114481	EM-M 030x045/0100 SC ...
3	4,5	50	12	6	2,80	2	S	7114482	EM-M 030x045/0120 SC ...
0,3	0,4	50	2	4	0,27	2	L	7114451	EM-M 003x004/0020 SC ...
0,5	0,7	50	4	4	0,45	2	L	7114453	EM-M 005x007/0040 SC ...
0,8	1,2	50	6	4	0,75	2	L	7114457	EM-M 008x012/0060 SC ...
1	1,5	50	6	4	0,90	2	L	7114460	EM-M 010x015/0060 SC ...
1	1,5	50	8	4	0,90	2	L	7114461	EM-M 010x015/0080 SC ...
1,2	1,8	50	8	4	1,10	2	L	7114464	EM-M 012x018/0080 SC ...
1,5	2,3	50	8	4	1,40	2	L	7114467	EM-M 015x023/0080 SC ...
1,5	2,3	50	10	4	1,40	2	L	7114468	EM-M 015x023/0100 SC ...
1,5	2,3	50	12	4	1,40	2	L	7114469	EM-M 015x023/0120 SC ...
2	3	50	12	4	1,90	2	L	7114473	EM-M 020x030/0120 SC ...
2	3	50	16	4	1,90	2	L	7114474	EM-M 020x030/0160 SC ...
2,5	3,7	50	16	4	2,40	2	L	7114478	EM-M 025x037/0160 SC ...
2,5	3,7	60	20	4	2,40	2	L	7114479	EM-M 025x037/0200 SC ...
3	4,5	60	16	6	2,80	2	L	7114483	EM-M 030x045/0160 SC ...
3	4,5	60	20	6	2,80	2	L	7114484	EM-M 030x045/0200 SC ...
0,5	0,7	50	6	4	0,45	2	XL	7114454	EM-M 005x007/0060 SC ...
0,5	0,7	50	8	4	0,45	2	XL	7114455	EM-M 005x007/0080 SC ...
0,8	1,2	50	8	4	0,75	2	XL	7114458	EM-M 008x012/0080 SC ...
0,8	1,2	50	10	4	0,75	2	XL	7114459	EM-M 008x012/0100 SC ...
1	1,5	50	10	4	0,90	2	XL	7114462	EM-M 010x015/0100 SC ...
1	1,5	50	12	4	0,90	2	XL	7114463	EM-M 010x015/0120 SC ...
1,2	1,8	50	12	4	1,10	2	XL	7114465	EM-M 012x018/0120 SC ...
1,5	2,3	50	16	4	1,40	2	XL	7114470	EM-M 015x023/0160 SC ...
2	3	60	20	4	1,90	2	XL	7114475	EM-M 020x030/0200 SC ...

Schnittwertempfehlungen ab Seite 154
 Cutting data recommendations starting page 154

■ = Hauptanwendung First choice
 □ = Nebenanwendung Second choice

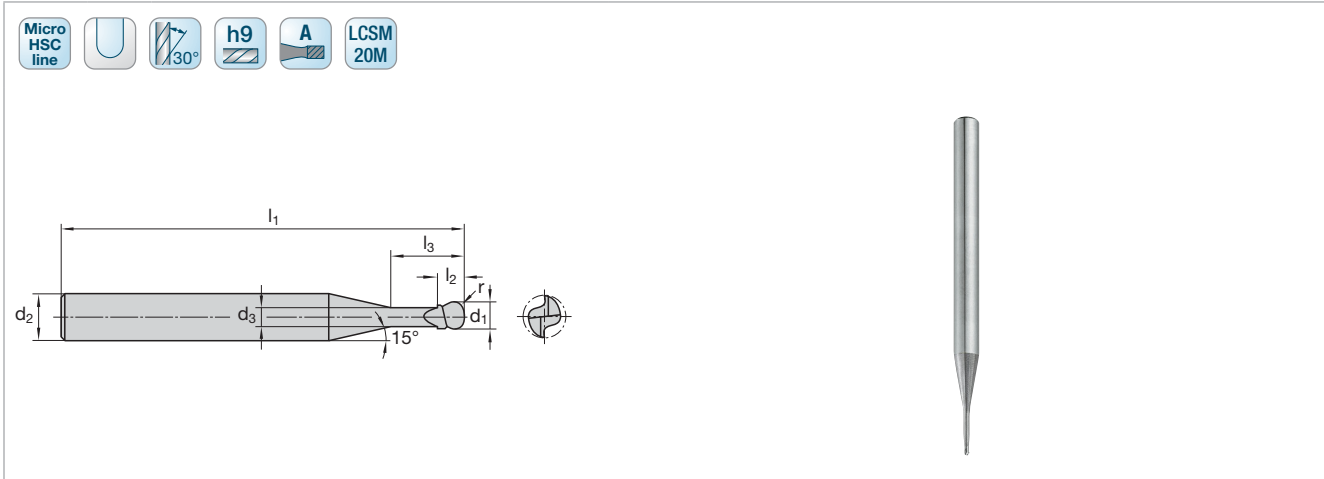

Katalog-Nr.	Cat.-No.	1476C
P		
M		■
K		
N		□
S		■
H		
O		

d ₁	l ₂	l ₁	l ₃	d ₂	d ₃	z	r		Ident No.	LMT-Code
0,8	0,6	50	2	4	0,75	2	0,40	XS	7114492	EM-M 008x006/0020 BN 0040 ...
1	0,8	50	3	4	0,90	2	0,50	XS	7114497	EM-M 010x008/0030 BN 0050 ...
2	1,6	50	4	4	1,90	2	1	XS	7114509	EM-M 020x016/0040 BN 0100 ...
2	1,6	50	6	4	1,90	2	1	XS	7114510	EM-M 020x016/0060 BN 0100 ...
3	2,4	50	8	6	2,80	2	1,50	XS	7114515	EM-M 030x024/0080 BN 0150 ...
0,3	0,3	50	1	4	0,27	2	0,15	S	7114485	EM-M 003x003/0010 BN 0015 ...
0,5	0,4	50	2	4	0,45	2	0,25	S	7114487	EM-M 005x004/0020 BN 0025 ...
0,8	0,6	50	4	4	0,75	2	0,40	S	7114493	EM-M 008x006/0040 BN 0040 ...
1	0,8	50	4	4	0,90	2	0,50	S	7114498	EM-M 010x008/0040 BN 0050 ...
2	1,6	50	8	4	1,90	2	1	S	7114511	EM-M 020x016/0080 BN 0100 ...
3	2,4	50	10	6	2,80	2	1,50	S	7114516	EM-M 030x024/0100 BN 0150 ...
0,3	0,3	50	2	4	0,27	2	0,15	L	7114486	EM-M 003x003/0020 BN 0015 ...
0,5	0,4	50	3	4	0,45	2	0,25	L	7114488	EM-M 005x004/0030 BN 0025 ...
0,5	0,4	50	4	4	0,45	2	0,25	L	7114489	EM-M 005x004/0040 BN 0025 ...
0,8	0,6	50	6	4	0,75	2	0,40	L	7114494	EM-M 008x006/0060 BN 0040 ...
1	0,8	50	6	4	0,90	2	0,50	L	7114499	EM-M 010x008/0060 BN 0050 ...
1	0,8	50	8	4	0,90	2	0,50	L	7114500	EM-M 010x008/0080 BN 0050 ...
1,2	1	50	8	4	1,10	2	0,60	L	7114503	EM-M 012x010/0080 BN 0060 ...
1,5	1,2	50	8	4	1,40	2	0,75	L	7114505	EM-M 015x012/0080 BN 0075 ...
1,5	1,2	50	12	4	1,40	2	0,75	L	7114506	EM-M 015x012/0120 BN 0075 ...
2	1,6	50	12	4	1,90	2	1	L	7114512	EM-M 020x016/0120 BN 0100 ...
2	1,6	50	16	4	1,90	2	1	L	7114513	EM-M 020x016/0160 BN 0100 ...
3	2,4	60	16	6	2,80	2	1,50	L	7114517	EM-M 030x024/0160 BN 0150 ...
3	2,4	60	20	6	2,80	2	1,50	L	7114518	EM-M 030x024/0200 BN 0150 ...
0,5	0,4	50	6	4	0,45	2	0,25	XL	7114490	EM-M 005x004/0060 BN 0025 ...
0,5	0,4	50	8	4	0,45	2	0,25	XL	7114491	EM-M 005x004/0080 BN 0025 ...
0,8	0,6	50	8	4	0,75	2	0,40	XL	7114495	EM-M 008x006/0080 BN 0040 ...
0,8	0,6	50	10	4	0,75	2	0,40	XL	7114496	EM-M 008x006/0100 BN 0040 ...
1	0,8	50	10	4	0,90	2	0,50	XL	7114501	EM-M 010x008/0100 BN 0050 ...
1	0,8	50	12	4	0,90	2	0,50	XL	7114502	EM-M 010x008/0120 BN 0050 ...
1,2	1	50	12	4	1,10	2	0,60	XL	7114504	EM-M 012x010/0120 BN 0060 ...
1,5	1,2	50	16	4	1,40	2	0,75	XL	7114507	EM-M 015x012/0160 BN 0075 ...
1,5	1,2	60	18	4	1,40	2	0,75	XL	7114508	EM-M 015x012/0180 BN 0075 ...
2	1,6	60	20	4	1,90	2	1	XL	7114514	EM-M 020x016/0200 BN 0100 ...
3	2,4	75	25	6	2,80	2	1,50	XL	7114519	EM-M 030x024/0250 BN 0150 ...

Schnittwertempfehlungen ab Seite 154
 Cutting data recommendations starting page 154

■ = Hauptanwendung First choice
 □ = Nebenanwendung Second choice

Vorteile der Micro HSCline:

- Genau auf die Anforderungen der unterschiedlichen Branchen abgestimmtes Programm
- Umfassendes Mikrofräser-Produktprogramm von 0,2 mm bis 3 mm
- Feinste Hartmetallsorten für höchste Ansprüche
- Speziell angepasste innovative Beschichtungen (inkl. Diamantbeschichtung)
- Neueste Techniken für optimale Werkzeuge (Finite-Element-Berechnungen, Schneidkantenpräparation, Beschichtungstechnologie ...)
- Wirtschaftliche Bearbeitung unterschiedlichster Werkstoffe

The benefits are obvious:

- Product range tailored specifically to meet the requirements of the different industries
- Comprehensive range of micro-cutter products from 0.2 mm to 3 mm
- Extremely fine-graded carbide types for highest demands
- Special adapted innovative coatings (including diamond coating)
- Latest techniques for optimized tools (finite element calculations, cutting edge preparation, coating technology ...)
- Cost-efficient processing of a wide range of different materials

Drei Halsgeometrien stehen zur Verfügung:

Three neck forms are available:

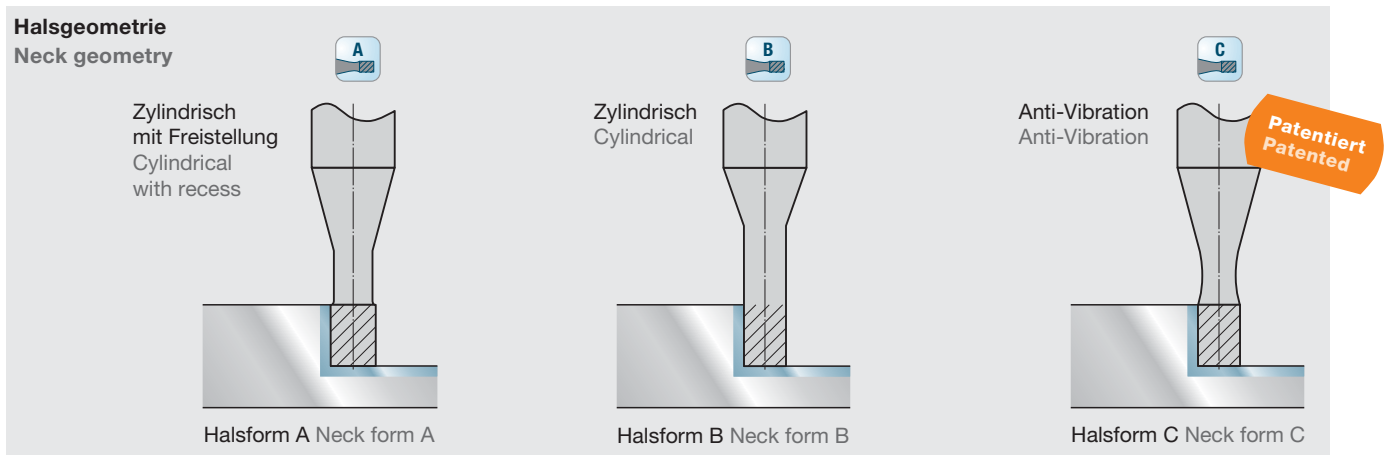

Die Anti-Vibrationsform (Halsform C)

The anti-vibration-form (Neck form C)

Merkmale der patentierten Anti-Vibrationsform:

- Stabiler Werkzeug-Kerndurchmesser
- Verschiebung der schwächsten Stelle in einen Bereich mit geringerer Belastung
- Berechnung mit Finiter-Elemente-Modellierung
- Patentierte Halsgeometrie

Features of the patented anti-vibration-geometry:

- Stronger tool core diameter
- Shifting of the weakest point of the shank to an area with lower pressure
- Construction with finite-element-method
- Patented neck geometry

Vorteile:

- Verringerung der Gefahr von Werkzeugbruch
- Reduzierung der auftretenden Normalspannung um bis zu 50 %
- Höhere Rundlaufgenauigkeit
- Höhere Maßgenauigkeit am Werkstück
- Höhere Prozesssicherheit

Advantages:

- Reduction of risk of tool breakage
- Reduction of the appearing force of the tool by 50 %
- Better concentricity
- Higher dimensional quality at the work piece
- Increased process reliability

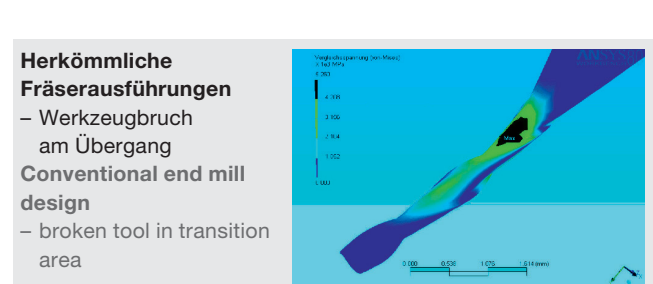
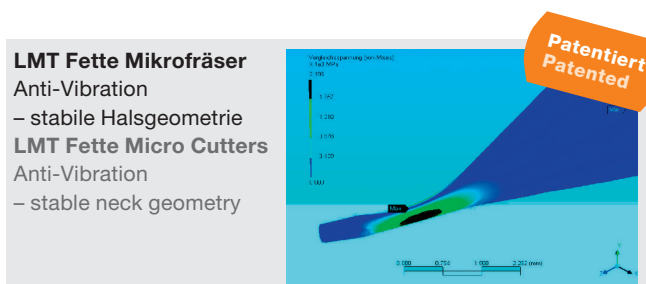

Vorschubgeschwindigkeit Feed rate $f_z = f_{z1} \cdot KFL$		
		KFL
XS	extra kurz extra short	1,35
S	kurz short	1
L	lang long	0,8
XL	extra lang extra long	0,6

KFL = Korrekturfaktor Länge
Correction factor length

Einteilung Ausführungslängen Classification design length		
		Verhältnis Relation l_3/d_1
XS	extra kurz extra short	2,0 – 3,0
S	kurz short	3,1 – 5,0
L	lang long	5,1 – 8,0
XL	extra lang extra long	8,1 – 20,0

Die angegebenen Schnittwerte sind Richtwerte und müssen auf die vorhandenen Bedingungen abgestimmt werden.
The cutting data indicated are guidelines and must be adjusted to the prevailing conditions.

Nutenfräsen
Slot milling

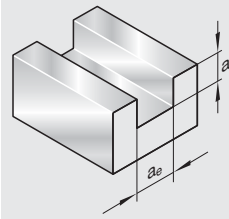

$$a_e = d_1$$

$$a_p = 0,08 \cdot d_1 \cdot KFL$$

Kantenfräsen
Side milling

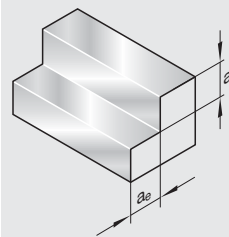

$$a_e = 0,1 \cdot d_1$$

$$a_p = 0,5 \cdot d_1 \cdot KFL$$

Kopierfräsen
Copy milling

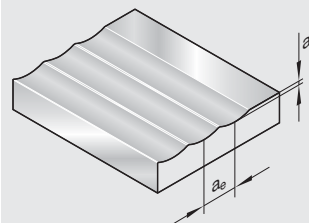

$$a_e = 0,05 \cdot d_1$$

(Schlichten, Finishing)

$$a_e = 0,1 \cdot d_1$$

(Schruppen, Roughing)

$$a_p = 0,5 \cdot d_1 \cdot KFL$$

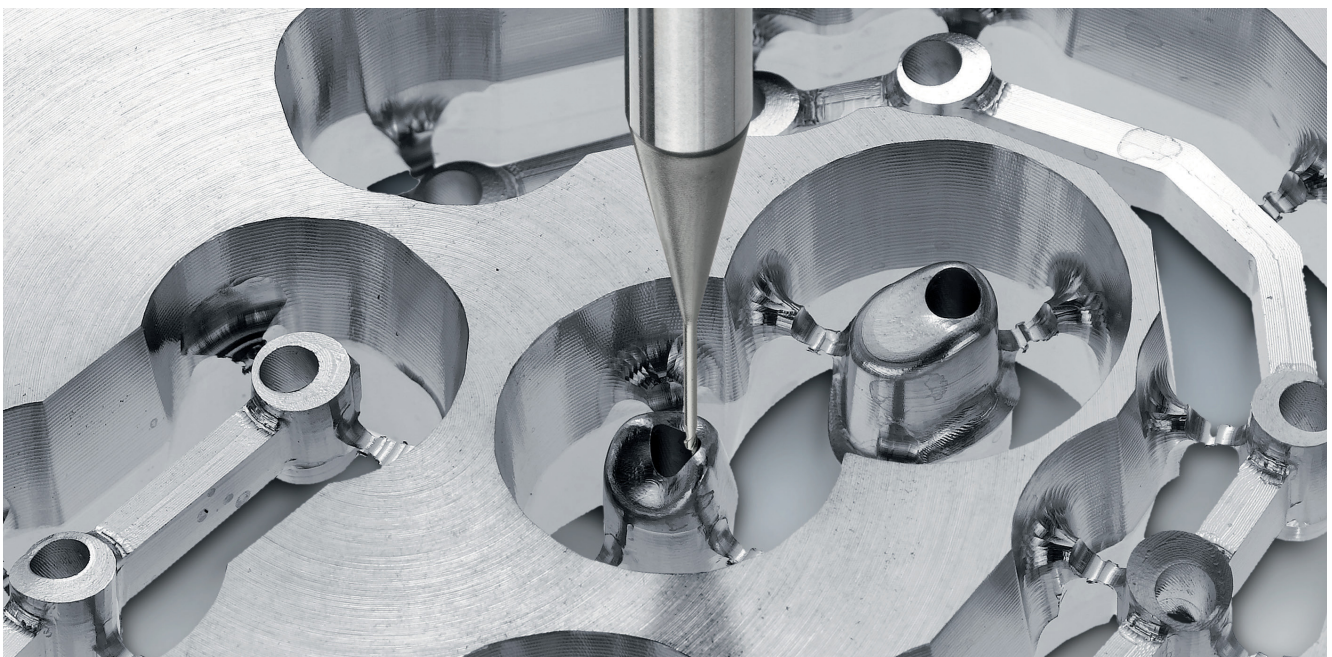

Bildquelle Sources: Firma Work NC-Dental®

Micro HSCline
Schnittwertempfehlungen für Schafffräser
Cutting data recommendations for end mills

	Werkstoff	Material	Werkstoff-Nr. Material No.	DIN Bezeichnung DIN Description	R _m /UTS (N/mm ²)	Schnittgeschwindigkeit	
						General machining	
						LWNP30M	LCPK30M
P	Automatenstahl	Free cutting steel	1.0715	9 SMn 28	-700	120	150
	Baustahl	Structural alloy steel	1.1191 1.7219	Ck 45, 26 CrMo 4	500-950	120	150
	Vergütungsstahl, mittelfest	Heat-treatment steel, medium strength	1.7225 1.2251	42 CrMo 4 50 CrV 4	500-950	120	150
	Stahlguss	Cast steel	1.0416	GS 40	-950	120	150
	Einsatzstahl	Case hardening steel	1.7131	16 MnCr 5	-950	120	150
	Rost- und säure- beständiger Stahl, ferritisch, martensitisch	Stainless steel, ferritic, martensitic	1.4006 1.4104 1.4122	X 10 Cr 13 X 12 CrMoS 17 X 35 CrMo 17	500-950	120	150
	Vergütungsstahl, hochfest	Heat-treatment steel, high strength	1.7225 1.6580	42 CrMo 4 30 CrNiMo 8	950-1400	100	130
	Nitrierstahl, vergütet	Nitriding steel, heat treated	1.8504	34 CrAl6	950-1400	100	130
	Werkzeugstahl	Tool steel	1.2343 1.2379	X 38 CrMoV 5 1 X 155 CrVMo 12 1	950-1400	100	130
M	Rost- und säure- beständiger Stahl, austenitisch	Stainless steel, austenitic	1.4301 1.4404 1.4751	X5CrNi18-10 X2CrNiMo17-12-2 X6CrNiMoTi17-12-2	500-950	100	130
	Rost- und säure- beständiger Stahl, ferritisch, martensitisch	Stainless steel, ferritic, martensitic	1.4024 1.4057 1.4122	X15Cr13 X17CrNi16-2 X35CrMo17	500-950	100	130
	Rost- und säure- beständiger Stahl, martensitisch aushärtbar	Stainless steel, martensitic steel	1.2709 1.4542 1.4568	X3NiCoMoTi18-9-5 X5CrNiCuNb16-4 X7CrNiAl17-7	800-1000	100	130
	Grauguss	Grey cast iron	0.6025	GG25	100-400 (120-260 HB)	150	180
K	Legierter Grauguss	Alloyed grey cast iron	06678	GGL-NiCr 35 2	150-300 (160-230 HB)	130	160
	Sphäroguss	Nodular cast iron	0.7060	GGG60	400-800 (120-310 HB)	120	150
	Temperguss	Malleable cast iron	0.8155	GTS55	350-700 (150-280 HB)	120	150
	Zirkonoxidkermaik	Zircon oxide ceramics		ZrO2	1200-1300 HV		
N	Aluminium-Legierungen, langspanend	Aluminium alloys, long chipping	3.3535 3.4365	AlMg 3 AlZnMgCu 1,5	-550	200	
	Aluminium-Legierungen, kurzspanend	Aluminium alloys, short chipping	3.2581	G-AlSi 12	-400	200	
	Kupfer-Legierungen, langspanend	Copper alloys, long chipping	2.0320 2.0975	MS63 CuAl10Ni	300-700	200	
	Kupfer-Legierungen, kurzspanend	Copper alloys, short chipping	2.0402	MS58	-500	200	
	Thermoplaste	Thermoplastics		PVC	40-70	200-400	
	Duroplaste	Duroplastics		Bakelit, Melamin	20-40	200-400	
	Graphit	Graphite		Graphite			
S	Titan-Legierungen, mittelfest	Titanium alloys, medium strength	3.7115 3.7165	TiAl5Sn2,5 TiAl6V4	-950		
	Titan-Legierungen, hochfest	Titanium alloys, high strength	3.7174	TiAl6Sn2	900-1400		
	Kobalt-Chrom-Legierung	Cobalt chromium alloys		CoCr	-890		
	Nickelbasis-Legierungen, mittelfest	Nickel based alloys, medium strength	2.4670	NiCr12Al6MoNb	-950		
	Nickelbasis-Legierungen, hochwarmfest	Heat resistant nickel based alloys, high strength	Inconel 718	NiCr19Fe19NbMo	900-1400		
H	Hartguss	Chilled cast iron		Ni-hard, Ampco	300-600 HB		
	Gehärteter Stahl	Hardened steel			45-52 HRC 53-59 HRC 60-65 HRC		

Die angegebenen Schnittwerte sind Richtwerte. In vielen Fällen kann die errechnete Drehzahl nicht erreicht werden. Benutzen Sie bitte die max. mögliche Drehzahl Ihrer Maschine (bitte Herstellerangaben beachten).
The specified cutting data are guidelines. In many cases, the calculated RPM can not be achieved.
Please use the max. possible spindle speed of your machine (refer manufacturer's manual).

Cutting speed v_c (m/min) ¹⁾			Ø 0,2 – Ø 0,4		Ø 0,5 – Ø 0,8		Ø 1,0 – Ø 1,4		Ø 1,5 – Ø 2,0		Ø 2,5 – Ø 3,0	
Mold and die		Dental medical										
LCN15M	LCHP15M	LCSM20M	f_{z1}	a_p	f_{z1}	a_p	f_{z1}	a_p	f_{z1}	a_p	f_{z1}	a_p
	250–300		0,03	0,015–0,03	0,04	0,04–0,06	0,05	0,08–0,12	0,06	0,12–0,15	0,08	0,15–0,20
	250–300		0,03	0,015–0,03	0,04	0,04–0,06	0,05	0,08–0,12	0,06	0,12–0,15	0,08	0,15–0,20
	250–300		0,03	0,015–0,03	0,04	0,04–0,06	0,05	0,08–0,12	0,06	0,12–0,15	0,08	0,15–0,20
	250–300		0,03	0,015–0,03	0,04	0,04–0,06	0,05	0,08–0,12	0,06	0,12–0,15	0,08	0,15–0,20
	250–300		0,03	0,015–0,03	0,04	0,04–0,06	0,05	0,08–0,12	0,06	0,12–0,15	0,08	0,15–0,20
	250–300		0,03	0,015–0,03	0,04	0,04–0,06	0,05	0,08–0,12	0,06	0,12–0,15	0,08	0,15–0,20
	200–300		0,02	0,015–0,025	0,03	0,03–0,05	0,04	0,06–0,10	0,05	0,10–0,13	0,06	0,12–0,18
	200–300		0,02	0,015–0,025	0,03	0,03–0,05	0,04	0,06–0,10	0,05	0,10–0,13	0,06	0,12–0,18
	200–300		0,02	0,015–0,025	0,03	0,03–0,05	0,04	0,06–0,10	0,05	0,10–0,13	0,06	0,12–0,18
		130	0,02	0,015–0,025	0,03	0,03–0,05	0,04	0,06–0,10	0,05	0,10–0,13	0,06	0,12–0,18
		130	0,02	0,015–0,025	0,03	0,03–0,05	0,04	0,06–0,10	0,05	0,10–0,13	0,06	0,12–0,18
		130	0,02	0,01–0,02	0,03	0,025–0,04	0,04	0,04–0,08	0,05	0,08–0,10	0,06	0,10–0,15
	180–250		0,03	0,015–0,03	0,04	0,04–0,06	0,05	0,08–0,12	0,06	0,12–0,15	0,08	0,15–0,20
	150–240		0,03	0,015–0,03	0,04	0,04–0,06	0,05	0,08–0,12	0,06	0,12–0,15	0,08	0,15–0,20
	130–220		0,03	0,015–0,03	0,04	0,04–0,06	0,05	0,08–0,12	0,06	0,12–0,15	0,08	0,15–0,20
	130–220		0,02	0,015–0,025	0,03	0,03–0,05	0,035	0,06–0,10	0,04	0,10–0,13	0,05	0,12–0,18
		300–400	0,01	0,02–0,03	0,015	0,04–0,06	0,02	0,08–0,10	0,03	0,12–0,15	0,04	0,15–0,20
			0,03	0,02–0,04	0,04	0,05–0,08	0,05	0,10–0,15	0,06	0,15–0,20	0,08	0,20–0,30
			0,03	0,02–0,04	0,04	0,05–0,08	0,05	0,10–0,15	0,06	0,15–0,20	0,08	0,20–0,30
			0,03	0,015–0,03	0,04	0,04–0,06	0,05	0,08–0,12	0,06	0,12–0,15	0,08	0,15–0,20
			0,03	0,015–0,03	0,04	0,04–0,06	0,05	0,08–0,12	0,06	0,12–0,15	0,08	0,15–0,20
			0,01	0,02–0,03	0,015	0,04–0,06	0,02	0,08–0,10	0,03	0,12–0,15	0,04	0,15–0,20
			0,01	0,02–0,03	0,015	0,04–0,06	0,02	0,08–0,10	0,03	0,12–0,15	0,04	0,15–0,20
200–300			0,04	0,04–0,06	0,05	0,10–0,12	0,06	0,12–0,20	0,08	0,20–0,35	0,10	0,30–0,50
		80–100	0,01	0,015–0,02	0,015	0,025–0,04	0,02	0,05–0,075	0,03	0,075–0,1	0,04	0,10–0,15
		60– 80	0,01	0,015–0,02	0,015	0,025–0,04	0,02	0,05–0,075	0,03	0,075–0,1	0,04	0,10–0,15
		130–150	0,01	0,02–0,03	0,015	0,04–0,06	0,02	0,08–0,10	0,03	0,12–0,15	0,04	0,15–0,20
		100–130	0,01	0,02–0,03	0,015	0,04–0,06	0,02	0,08–0,10	0,03	0,12–0,15	0,04	0,15–0,20
		120–150	0,01	0,02–0,03	0,015	0,04–0,06	0,02	0,08–0,10	0,03	0,12–0,15	0,04	0,15–0,20
	180–220		0,025	0,02–0,04	0,03	0,05–0,08	0,04	0,10–0,15	0,045	0,10–0,20	0,06	0,15–0,25
	180–220		0,025	0,02–0,04	0,03	0,05–0,08	0,04	0,10–0,15	0,045	0,10–0,20	0,06	0,15–0,25
	160–180		0,02	0,012–0,025	0,025	0,03–0,05	0,035	0,05–0,08	0,04	0,08–0,12	0,05	0,12–0,18
	140–160		0,01	0,01–0,015	0,015	0,02–0,032	0,02	0,04–0,06	0,03	0,06–0,08	0,04	0,08–0,15

¹⁾ Schnittwerte für Ausführung S (kurz), Korrekturfaktoren für alle anderen Ausführungen Seite 153
 Cutting data for design length S (short), correction factor for the other design length see page 153

Dynamisches Fräsen generiert neue Leistungsimpulse

Bisher zeigten die LMT Hochleistungswerkzeuge bei den bekannten Verfahren Hochgeschwindigkeitsfräsen (HSC), das vorwiegend zur Erzeugung sehr guter Schlichtoberflächen genutzt wird oder auch beim Hochvorschubfräsen (HFC) zum Abtragen großer Spanvolumen ihr wahres Können. Nun kommt das trochoide Fräsen als neuer Leistungsträger hinzu.

Nach wie vor rotiert dabei der Fräser mit einer konstanten Drehzahl. Aber im Gegensatz zum konventionellen Nuten- oder Kantenfräsen führt das Werkzeug beim trochoiden Fräsen keine lineare Vorschubbewegung mit konstantem Zahnvorschub aus, sondern bewegt sich sehr schnell auf kurvenförmigen Bahnen, den sogenannten Trochoiden.

Durch die Überlagerung von Vorschubbewegung und Kreisbewegung werden die Eingriffsbedingungen positiv verändert. Der Zahnvorschub f_z , die radiale Eingriffsgröße a_e und der Umschlingungswinkel β ändern sich permanent. Das Programmiersystem kombiniert diese Parameter so miteinander, dass die Mittenspanndicke und somit die Belastung der Schneiden permanent konstant bleiben. Dadurch wird eine übermäßige und ungleichmäßige Belastung der Schneiden und auch der Maschinespindel vermieden.

Dynamic milling boots performance

Until now, high-performance tools by LMT demonstrated their ability on the established procedures high-speed cutting (HSC), which is predominantly used to generate excellent finishing surfaces, and high feed cutting (HFC) that serves to remove large chip volumes. Now, the top performer trochoidal milling completes the choice.

Here, the cutter still rotates at constant speed. However, as opposed to conventional slot and edge milling, during trochoidal milling this tool does not perform linear feed motions with constant chip load. It rather moves very quickly on curved paths, the so-called trochoids.

The superposition of feed and circular motion has a positive impact on the operation conditions. The chip load f_z , the radial depth of the cut a_e and the wrap angle β constantly change. The programming system combines these parameters in such a way that the mean chip thickness and thus the stress on the cutting blades remain constant over the entire process. This avoids an excessive and uneven distribution of force on the cutting blades and the machine spindle.



Vorschubbewegung und Spanbildung beim trochoiden Fräsen
Feed motion and chip formation in trochoidal milling

Grundsätzlich gilt: Je größer der Umschlingungswinkel ist, umso mehr Zerspanungswärme geht in die Werkzeugschneide. Beim trochoiden Fräsen liegt dieser Winkel während eines Fräszyklus in der Größenordnung 10° bis maximal 80° und damit deutlich niedriger als 180°, wie z. B. beim konventionellen Nutenfräsen. Damit werden auch die thermische und mechanische Belastung der Schneide wesentlich reduziert.

Ausgezeichnete Oberflächenqualität

Aufgrund der geringen Kräfte beim trochoiden Fräsen sind große axiale Werkzeugzustellungen möglich. Dies erlaubt auch bei Leistungsschwächeren Maschinen die Nutzung der gesamten Schneidenlänge.

Der Anwendernutzen auf einen Blick:

- Drastische Senkung der Fertigungskosten durch hohe Bearbeitungsgeschwindigkeit
- Geringe Zerspankräfte aufgrund kleinerer und gleichbleibender Spanquerschnitte
- Verkürzung der Bearbeitungszeiten um 70 %
- Steigerung der Standzeit um mehr als 300 %
- Vorteile beim Schruppen und Schlichten

Auf Seite 158 und 159 finden Sie die erhöhten Schnittwerte, speziell ermittelt für den Einsatz der Frässtrategie Trochoides oder Dynamisches Fräsen.

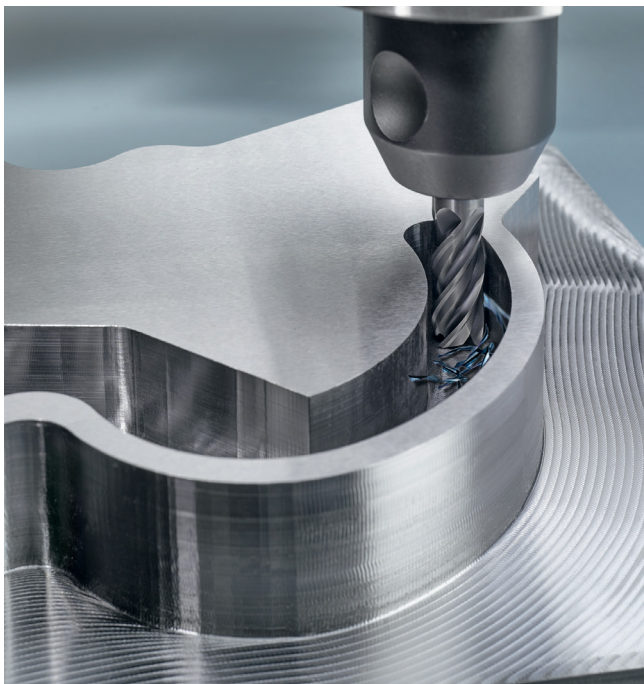

Geringe Zerspankräfte ermöglichen auch maßhaltige, dünne Wandungen
Low cutting forces also enable dimensional accuracy of very thin-walled workpieces

In principle, the following applies: The larger the wrap angle, the more heat from the machining process will be transferred to the tool blade. In trochoidal milling, the wrap angle during a milling cycle is 10° to max. 80° and is thus significantly smaller than the 180° used in e.g. conventional slot milling. This enables a significant reduction of the thermal and mechanical load on the blade.

Excellent surface quality

Due to the reduced presence of forces during the machining process a bigger axial depth of cut is possible. This allows the usage of the entire cutting edge even on less powerful machining centers.

The user benefits at a glance:

- Significant reduction in manufacturing costs thanks to increased processing speed
- Low cutting forces due to smaller and consistent chip cross-sections
- Reduction of the machining time by 70 %
- Increase of tool life by more than 300 %
- Benefits in roughing and finishing

On the pages 158 and 159 you find the increased cutting values, determined especially for the milling strategies trochoidal milling or dynamic milling.

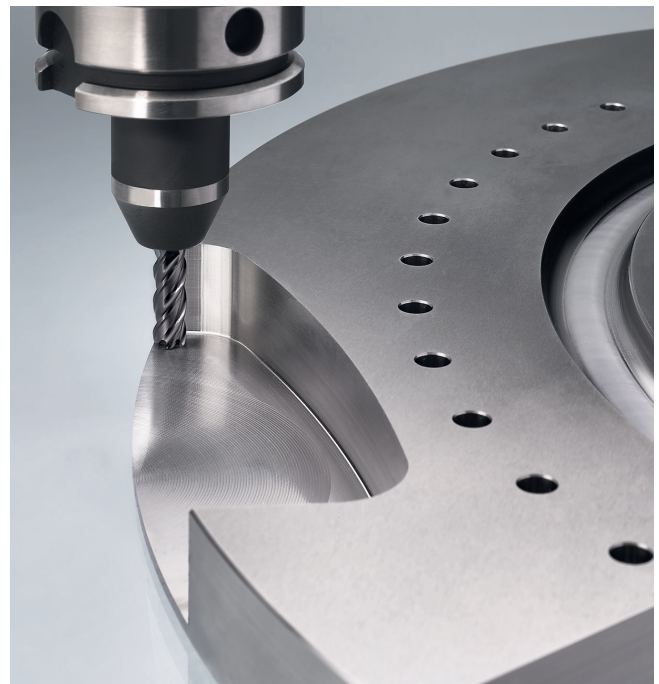

Trochoides Fräsen eines gehärteten Bauteils unter Extrembedingungen
Trochoidal milling of a hardened component under extreme conditions

Schnittwertempfehlungen Cutting data recommendations

DHC HARDLINE						
	Werkstoff	Material	Werkstoff-Nr. Material No.	DIN Bezeichnung Alt DIN Description Old	R _m /UTS (N/mm ²)	DIN Bezeichnung Neu DIN Description New
P	Nitrier- und Vergütungsstahl	Nitriding steel and heat-treatment steel	1.7225	42CrMo4	950–1400	42CrMo4
			1.2344	X40CrMoV5.1	–900	X40CrMoV5-1
			1.4104	X12CrMoS17	500–950	X14CrMoS17
			1.8504	34CrAl6	950–1400	34CrAl6
	Werkzeugstahl	Tool steel	1.2343	X38CrMoV5 1	950–1400	X37CrMoV5-1
			1.6580	30CrNiMo8	950–1400	30CrNiMo8
			1.2379	X155CrVMo12 1	–950	X153CrMoV12-1
			1.2080	X210Cr12	950–1400	X210Cr12
			1.2311	40CrMnMo7	–1100	40CrMnMo7
			1.2312	40CrMnNiMoS8.6	–1150	40CrMnNiMoS8-6
			1.2738	45CrMnNiMo8.6.4	950–1150	45CrMnNiMo8-6-4
			1.2358	60CrMoV18-5	850–1000	60CrMoV18-5
			1.2714	55NiCrMoV7	1100–1350	55NiCrMoV7
			K	Grauguss	Grey cast iron	0.6025
Legierter Grauguss	Alloyed grey cast iron	0.6678		GGL-NiCr35 2	150–250 (160–230 HB)	EN-GJLA-XNiCr35-2
Sphäroguss	Nodular cast iron	0.7060 0.7070		GGG60 GGG70L	400–800 (120–310 HB)	EN-GJS-600-3 EN-GJS-700-2U
Temperguss	Malleable cast iron	0.8155		GTS55	350–700 (150–280 HB)	EN-GJMB-550-4
H	Gehärteter Stahl	Hardened steel		Sleipner, Toolox	45–49 HRC	Sleipner, Toolox
				Dievar	50–54 HRC	Dievar
				Vandis, Sverker	55–57 HRC	Vandis, Sverker
					58–60 HRC	
					61–63 HRC	

DHC INOX DHC INOX Premium						
	Werkstoff	Material	Werkstoff-Nr. Material No.	DIN Bezeichnung Alt DIN Description Old	R _m /UTS (N/mm ²)	DIN Bezeichnung Neu DIN Description New
M	Rost- und säurebeständiger Stahl, austenitisch	Stainless steel, austenitic	1.4301	X2CrNiMo17-12-2	500–950	X5CrNiMo18-10
			1.4404	X6CrNiMoTi17-12-2		X2CrNiMo17-12-2
			1.4571	X10CrNiMoTi18		X10CrNiMoTi18
	Rost- und säurebeständiger Stahl, ferritisch, martensitisch	Stainless steel, ferritic, martensitic	1.4024	X15Cr13	500–950	X15Cr13
			1.4057	X17CrNi16-2		X17CrNi16-2
			1.4122	X35CrMo17		X35CrMo17
Rost- und säurebeständiger Stahl, martensitisch aushärtbar	Stainless steel, martensitic steel	1.2709	X3NiCoMoTi18-9-5	800–1000	X3NiCoMoTi18-9-5	
		1.4542	X5CrNiCuNb16-4		X5CrNiCuNb16-4	
		1.4568	X7CrNiAl17-7		X7CrNiAl17-7	
N	Aluminium-Legierungen, kurzspanend	Aluminium alloys, short chipping	3.2581	G-AISi12	–400	G-IGK-AISi12
	Aluminium-Legierungen, langspanend	Aluminium alloys, long chipping	2.0402	MS58	–500	AlMg3 AlZnMgCu1,5
S	Titan-Legierungen, mittelfest	Titanium alloys, medium strength	3.7164 3.7115	TiAl6V4 TiAl5Sn2,5	–950	TiAl5Sn2-5 Ti6AlV4
	Titan-Legierungen, hochfest	Titanium alloys, high strength	3.7174	TiAl6Sn2	900–1400	TiAl6V6Sn2
	Nickelbasis-Legierungen, mittelfest	Nickel based alloys, medium strength	2.4670	NiCr12Al6MoNb	–950	NiCr12Al6MoNb
	Nickelbasis-Legierungen, hochwarmfest	Heat resistant nickel based alloys, high strength	2.4668	NiCr19Fe19NbMo	900–1400	Inconel 718 NiCr19Fe19Nb5Mo3

Ausgegangen von der langen Variante. Schneidlänge 1,5 x d bis max l₃.

Die angegebenen Schnittwerte sind Startwerte und müssen auf die vorhandenen Bedingungen abgestimmt werden.

Assuming the use of the long version. Depth of cut 1.5 x d to max l₃.

The cutting data indicated are starting values based and must be adjusted to the prevailing conditions.

	Eingriffswinkel Pressure angle	a_e / D	Schnitt- geschwindigkeit Cutting speed v_c (m/min)	Fräserdurchmesser Cutting diameter (mm)		
				Vorschub pro Zahn Feed per tooth f_z (mm/z.)		
				Ø 6-8	Ø 10-12	Ø 16-20
35-45°	0,09-0,15 x D		280-320	0,10-0,15	0,15-0,2	0,2-0,3
			280-320	0,10-0,15	0,15-0,2	0,2-0,3
			280-320	0,10-0,15	0,15-0,2	0,2-0,3
			280-320	0,10-0,15	0,15-0,2	0,2-0,3
			250-300	0,08-0,12	0,12-0,18	0,18-0,25
			280-320	0,10-0,15	0,15-0,2	0,2-0,3
			250-300	0,08-0,12	0,12-0,18	0,18-0,25
			250-300	0,08-0,12	0,12-0,18	0,18-0,25
			280-320	0,10-0,15	0,15-0,2	0,2-0,3
			300-350	0,15-0,2	0,2-0,25	0,25-0,35
			280-320	0,10-0,15	0,15-0,2	0,2-0,3
			250-300	0,08-0,12	0,12-0,18	0,18-0,25
			250-300	0,08-0,12	0,12-0,18	0,18-0,25
35-45°	0,09-0,15 x D		400-450	0,2-0,25	0,25-0,3	0,3-0,4
			350-400	0,15-0,2	0,2-0,25	0,25-0,35
			300-350	0,15-0,2	0,2-0,25	0,25-0,35
			280-320	0,10-0,15	0,15-0,2	0,2-0,3
35-40°	0,09-0,12 x D		300-340	0,1-0,15	0,15-0,2	0,2-0,25
30-35°	0,065-0,09 x D		260-320	0,08-0,12	0,12-0,18	0,14-0,2
25-30°	0,05-0,065 x D		180-240	0,06-0,09	0,08-0,11	0,1-0,14
20-25°	0,03-0,05 x D		120-160	0,04-0,06	0,06-0,08	0,07-0,1
15-20°	0,015-0,03 x D		60-100	0,02-0,04	0,03-0,05	0,04-0,07

	Eingriffswinkel Pressure angle	a_e / D	Schnitt- geschwindigkeit Cutting speed v_c (m/min)	Fräserdurchmesser Cutting diameter (mm)				
				Vorschub pro Zahn Feed per tooth f_z (mm/z.)				
				Ø 4-5	Ø 6-8	Ø 10-12	Ø 14-16	Ø 18-20
35-45°	0,09-0,15 x D		100-160	0,05-0,08	0,08-0,12	0,1-0,15	0,15-0,2	0,2-0,25
			120-180	0,05-0,08	0,08-0,14	0,12-0,17	0,15-0,22	0,2-0,3
			250-300	0,08-0,12				
			280-320	0,10-0,15				
			100-160	0,05-0,08	0,08-0,12	0,1-0,15	0,15-0,2	0,2-0,25
			250-300	0,10-0,15				
280-320	0,10-0,15							
55-65°	0,21-0,3 x D		600-700	0,05-0,1	0,1-0,15	0,15-0,2	0,2-0,25	0,25-0,3
			500-600	0,05-0,1	0,1-0,15	0,15-0,2	0,2-0,25	0,25-0,3
25-35°	0,05-0,09 x D		100-150	0,04-0,08	0,06-0,1	0,1-0,15	0,12-0,17	0,15-0,2
20-30°	0,03-0,065 x D		80-120	0,04-0,08	0,06-0,1	0,1-0,15	0,12-0,17	0,15-0,2
15-25°	0,015-0,05 x D		60-100	0,03-0,06	0,05-0,08	0,08-0,12	0,1-0,15	0,12-0,17
15-25°	0,015-0,05 x D		60-100	0,03-0,06	0,05-0,08	0,08-0,12	0,1-0,15	0,12-0,17



**Weitere Schnittwertempfehlungen
für trochoides Fräsen**
 Further cutting data recommendations
 for trochoidal milling



Katalog-Nr. Cat.-No.		Quattro-Jet HF						
P		■						
M		■						
K		■						
N								
S		□						
H								
d	R _{theo}	l ₁	M	SW ¹⁾	z	Geometrie Geometry	Ident No.	LMT-Code
12	1,2	18	6	10	4	HF	7025136	MFS 12 HF TC 18 - I
16	1,6	23	8	13	4	HF	7025137	MFS 16 HF TR 23 - I
20	2,0	26	10	17	4	HF	7025138	MFS 20 HF TS 26 - I

Katalog-Nr. Cat.-No.		Quattro-Jet FB						
P		■						
M		□						
K		■						
N								
S		□						
H		■						
d	r	l ₁	M	SW ¹⁾	z	Geometrie Geometry	Ident No.	LMT-Code
12	5	18	6	10	4	FB	7025130	MFS 12 FB 50 TC 18
16	7	23	8	13	4	FB	7025131	MFS 16 FB 70 TR 23
20	9	26	10	17	4	FB	7025132	MFS 20 FB 90 TS 26

Weitere Informationen zur Geometrie des FlatBall® finden Sie auf Seite 49.
 Further information about the geometry of the FlatBall® see page 49.

¹⁾ Schlüsselweite
 Hex size

Schnittwertempfehlungen ab Seite 162
 Cutting data recommendations starting page 162

■ = Hauptanwendung First choice
 □ = Nebenanwendung Second choice
 Passende Verlängerungen siehe Seite 167
 Suitable extensions see page 167

Katalog-Nr. Cat.-No.		Quattro-Jet AF						
P		■						
M		□						
K		■						
N		■						
S		□						
H		■						
d	r	l ₁	M	SW ¹⁾	z	Geometrie Geometry	Ident No.	LMT-Code
12	1	18	6	10	4	AF	7025133	MFS 12 AF 10 TC 18
16	1	23	8	13	4	AF	7025134	MFS 16 AF 10 TR 23
20	1	26	10	17	4	AF	7025135	MFS 20 AF 10 TS 26

Katalog-Nr. Cat.-No.		Quattro-Jet SF						
P		■						
M		□						
K		■						
N		■						
S		□						
H		■						
d	r	l ₁	M	SW ¹⁾	z	Geometrie Geometry	Ident No.	LMT-Code
12	6	18	6	10	4	SF	7025139	MFS 12 SF TC 18
16	8	23	8	13	4	SF	7025140	MFS 16 SF TR 23
20	10	26	10	17	4	SF	7025141	MFS 20 SF TS 26

¹⁾ Schlüsselweite
 Hex size

Schnittwertempfehlungen ab Seite 162
 Cutting data recommendations starting page 162

■ = Hauptanwendung First choice
 □ = Nebenanwendung Second choice

Quattro-Jet
Schnittwertempfehlungen
Cutting data recommendations

	Werkstoff	Material	Werkstoff-Nr. Material No.	DIN Bezeichnung Alt DIN Description Old	R_m/UTS (N/mm²)	DIN Bezeichnung Neu DIN Description New
P	Unlegierter Baustahl + Automatenstahl	Plain carbon steel + free cutting steel	1.0570	St52-3	-700	S355J2G3
			1.1730	C45	-800	C45U
			1.0715	9SMn28	-700	11SMn30
			1.1191 1.7219	Ck45 26CrMo4	500-950	C45E 26CrMo4-2
	Vergütungsstahl, mittelfest	Heat-treatment steel, medium strength	1.7225 1.8159	42CrMo4 51CrV4	500-950	42CrMo4 51CrV4
	Stahlguss	Cast steel	1.0416	GS40	-950	GS40
	Einsatzstahl	Case hardening steel	1.7131	16MnCr5	-950	16MnCr5
	Rost- und säurebe- ständiger Stahl, ferritisch, martensitisch	Stainless steel, ferritic, martensitic	1.4006	X10Cr13	500-950	X12Cr13
			1.4104	X12CrMoS17		X14CrMoS17
			1.4122	X35CrMo17		X39CrMo17-1
	Vergütungsstahl, hochfest	Heat-treatment steel, high strength	1.7225 1.6580	42CrMo4 30CrNiMo8	950-1400	42CrMo4 30CrNiMo8
	Nitrierstahl, vergütet	Nitriding steel, heat treated	1.8504 1.2344	34CrAl6 X40CrMoV5.1	950-1400 -900	34CrAl6 X40CrMoV5-1
	Werkzeugstahl	Tool steel	1.2343	X38CrMoV5 1	950-1400	X37CrMoV5-1
			1.2379	X155CrVMo12 1	-950	X153CrMoV12-1
1.2358			60CrMoV18-5	850-1000	60CrMoV18-5	
1.2080			X210Cr12	950-1400	X210Cr12	
1.2714			55NiCrMoV7	1100-1350	55NiCrMoV7	
1.2311			40CrMnMo7	-1100	40CrMnMo7	
1.2312			40CrMnNiMoS8.6	-1150	40CrMnNiMoS8-6	
1.2316 1.2738			X38CrMo16 45CrMnNiMo8.6.4	-1100 950-1150	X38CrMo16 45CrMnNiMo8-6-4	
M	Rost- und säurebe- ständiger Stahl, austenitisch	Stainless steel, austenitic	1.4301	X2CrNiMo17-12-2	500-950	X5CrNiMo18-10
			1.4404	X6CrNiMoTi17-12-2		X2CrNiMo17-12-2
			1.4571	X10CrNiMoTi18		X10CrNiMoTi18
	Rost- und säurebe- ständiger Stahl, martensitisch aushärtbar	Stainless steel, martensitic steel	1.2709 1.4542 1.4568	X3NiCoMoTi18-9-5 X5CrNiCuNb16-4 X7CrNiAl17-7	800-1000	X3NiCoMoTi18-9-5 X5CrNiCuNb16-4 X7CrNiAl17-7
K	Grauguss	Grey cast iron	0.6025	GG25	100-400 (120-260 HB)	EN-GJI-250
	Legierter Grauguss	Alloyed grey cast iron	0.6678	GGL-NiCr35 2	150-250 (160-230 HB)	EN-GJLA-XNiCr35-2
	Sphäroguss	Nodular cast iron	0.7060 0.7070	GGG60 GGG70L	400-800 (120-310 HB)	EN-GJS-600-3 EN-GJS-700-2U
	Temperguss	Malleable cast iron	0.8155	GTS55	350-700 (150-280 HB)	EN-GJMB-550-4
S	Titan-Legierungen, mittelfest	Titanium alloys, medium strength	3.7115 3.7164	TiAl5Sn2,5 TiAl6V4	-950	TiAl5Sn2-5 Ti6AlV4
	Titan-Legierungen, hochfest	Titanium alloys, high strength	3.7174	TiAl6Sn2	900-1400	TiAl6V6Sn2
	Nickelbasis-Legierungen, mittelfest	Nickel based alloys, medium strength	2.4670	NiCr12Al6MoNb	-950	NiCr12Al6MoNb
	Nickelbasis-Legierungen, hochwarmfest	Heat resistant nickel based alloys, high strength	2.4668	NiCr19Fe19NbMo	900-1400	Inconel 718 NiCr19Fe19Nb5Mo3
	Kobalt-Chrom-Legierung	Cobalt chromium alloys				
H	Hartguss	Chilled cast iron		Ni-hard, Ampco	300-600 HB	Ni-hard, Ampco
	Gehärteter Stahl	Hardened steel			45-52 HRC	
					53-59 HRC	
60-65 HRC						

Die angegebenen Schnittwerte sind Startwerte und müssen auf die vorhandenen Bedingungen abgestimmt werden.
The cutting data indicated are starting values and must be adjusted to the prevailing conditions.

	Schnittgeschwindigkeit Schruppen Cutting speed Roughing	Ø 12	Ø 16	Ø 20	a _e Schruppen Roughing	Schnittgeschwindigkeit Schlichten Cutting speed Finishing	Schnittgeschwindigkeit Schlichten Cutting speed Finishing	Ø 12	Ø 16	Ø 20	a _e Schlichten Finishing
	Typ HF Type HF	a _p max f _z	a _p max f _z	a _p max f _z	Typ HF Type HF	Typ SF Type SF	Typ FB Type FB	a _p max f _z	a _p max f _z	a _p max f _z	Typ SF/FB Type SF/FB
	180–200	0,60 0,60	0,80 0,80	1,00 0,80	d x 0,7	260–280	220–240	0,15 0,20	0,20 0,35	0,25 0,40	d x 0,022
	180–200	0,60 0,60	0,80 0,80	1,00 0,80		260–280	260–280	0,15 0,20	0,20 0,35	0,25 0,40	
	180–200	0,60 0,60	0,80 0,80	1,00 0,80		280–300	280–300	0,15 0,20	0,20 0,35	0,25 0,40	
	180–200	0,50 0,50	0,60 0,50	0,80 0,50		260–280	220–240	0,15 0,20	0,20 0,35	0,25 0,40	
	160–180	0,50 0,50	0,60 0,50	0,80 0,50		240–260	220–240	0,15 0,20	0,20 0,35	0,25 0,40	
	140–160	0,50 0,50	0,60 0,50	0,80 0,50		260–280	200–220	0,15 0,20	0,20 0,35	0,25 0,40	
	140–160	0,50 0,50	0,60 0,50	0,80 0,50		280–300	240–260	0,15 0,20	0,20 0,35	0,25 0,40	
	180–200	0,60 0,50	0,80 0,60	0,80 0,80		300–340	250–300	0,15 0,20	0,20 0,35	0,25 0,40	
	140–160	0,60 0,40	0,80 0,60	0,80 0,80	d x 0,7	220–240	220–240	0,15 0,20	0,20 0,35	0,25 0,40	d x 0,022
	140–160	0,60 0,40	0,80 0,60	0,80 0,80		220–240	220–240	0,15 0,20	0,20 0,35	0,25 0,40	
	180–200	0,60 0,60	0,80 0,80	1,00 1,00	d x 0,7	300–320	240–260	0,20 0,25	0,25 0,35	0,30 0,40	d x 0,022
	180–200	0,50 0,50	0,60 0,60	0,80 0,80		240–260	220–240	0,20 0,25	0,25 0,35	0,30 0,40	
	180–200	0,50 0,50	0,60 0,60	0,80 0,80		320–340	340–360	0,20 0,25	0,25 0,35	0,30 0,40	
	180–200	0,50 0,50	0,60 0,60	0,80 0,80		240–280	280–300	0,20 0,25		0,30 0,40	
	80–100	0,40 0,40	0,50 0,50	0,50 0,60	d x 0,7	180–200					
	60–80	0,40 0,40	0,50 0,50	0,50 0,60		280–300					
	100–120	0,40 0,40	0,50 0,50	0,50 0,60		240–260	100–120	0,20 0,20	0,25 0,35	0,30 0,40	d x 0,022
	80–100	0,40 0,40	0,50 0,50	0,50 0,60		200–220	80–100	0,20 0,20	0,25 0,35	0,30 0,40	
						180–200	180–200	0,10 0,18	0,15 0,20	0,20 0,25	d x 0,022
						280–300	240–260	0,10 0,18	0,15 0,20	0,20 0,30	
						240–260	220–240	0,10 0,18	0,15 0,20	0,20 0,25	
						200–220	120–140	0,10 0,18	0,15 0,20	0,20 0,25	

Quattro-Jet
Schnittwertempfehlungen
Cutting data recommendations

	Werkstoff	Material	Werkstoff-Nr. Material No.	DIN Bezeichnung Alt DIN Description Old	R_m/UTS (N/mm²)	DIN Bezeichnung Neu DIN Description New
P	Unlegierter Baustahl + Automatenstahl	Plain carbon steel + free cutting steel	1.0570	St52-3	-700	S355J2G3
			1.1730	C45	-800	C45U
			1.0715	9SMn28	-700	11SMn30
			1.1191 1.7219	Ck45 26CrMo4	500-950	C45E 26CrMo4-2
	Vergütungsstahl, mittelfest	Heat-treatment steel, medium strength	1.7225	42CrMo4	500-950	42CrMo4
	Stahlguss	Cast steel	1.8159	51CrV4		51CrV4
			1.0416	GS40	-950	GS40
	Einsatzstahl	Case hardening steel	1.7131	16MnCr5	-950	16MnCr5
	Rost- und säurebe- ständiger Stahl, ferritisch, martensitisch	Stainless steel, ferritic, martensitic	1.4006	X10Cr13	500-950	X12Cr13
			1.4104	X12CrMoS17		X14CrMoS17
			1.4122	X35CrMo17		X39CrMo17-1
	Vergütungsstahl, hochfest	Heat-treatment steel, high strength	1.7225	42CrMo4	950-1400	42CrMo4
	Nitrierstahl, vergütet	Nitriding steel, heat treated	1.6580	30CrNiMo8		30CrNiMo8
			1.8504	34CrAl6	950-1400	34CrAl6
	Werkzeugstahl	Tool steel	1.2344	X40CrMoV5.1	-900	X40CrMoV5-1
			1.2343	X38CrMoV5 1	950-1400	X37CrMoV5-1
			1.2379	X155CrVMo12 1	-950	X153CrMoV12-1
			1.2358	60CrMoV18-5	850-1000	60CrMoV18-5
			1.2080	X210Cr12	950-1400	X210Cr12
1.2714			55NiCrMoV7	1100-1350	55NiCrMoV7	
1.2311			40CrMnMo7	-1100	40CrMnMo7	
1.2312	40CrMnNiMoS8.6	-1150	40CrMnNiMoS8-6			
1.2316	X38CrMo16	-1100	X38CrMo16			
1.2738	45CrMnNiMo8.6.4	950-1150	45CrMnNiMo8-6-4			
M	Rost- und säurebe- ständiger Stahl, austenitisch	Stainless steel, austenitic	1.4301	X2CrNiMo17-12-2	500-950	X5CrNiMo18-10
			1.4404	X6CrNiMoTi17-12-2		X2CrNiMo17-12-2
			1.4571	X10CrNiMoTi18		X10CrNiMoTi18
Rost- und säurebe- ständiger Stahl, martensitisch aushärtbar	Stainless steel, martensitic steel	1.2709	X3NiCoMoTi18-9-5	800-1000	X3NiCoMoTi18-9-5	
		1.4542	X5CrNiCuNb16-4		X5CrNiCuNb16-4	
		1.4568	X7CrNiAl17-7		X7CrNiAl17-7	
K	Grauguss	Grey cast iron	0.6025	GG25	100-400 (120-260 HB)	EN-GJ1-250
			0.6678	GGL-NiCr35 2	150-250 (160-230 HB)	EN-GJLA-XNiCr35-2
	Sphäroguss	Nodular cast iron	0.7060	GGG60	400-800	EN-GJS-600-3
			0.7070	GGG70L	(120-310 HB)	EN-GJS-700-2U
Temperguss	Malleable cast iron	0.8155	GTS55	350-700 (150-280 HB)	EN-GJMB-550-4	
S	Titan-Legierungen, mittelfest	Titanium alloys, medium strength	3.7115	TiAl5Sn2,5	-950	TiAl5Sn2-5
			3.7164	TiAl6V4		Ti6AlV4
	Titan-Legierungen, hochfest	Titanium alloys, high strength	3.7174	TiAl6Sn2	900-1400	TiAl6V6Sn2
			2.4670	NiCr12Al6MoNb	-950	NiCr12Al6MoNb
	Nickelbasis-Legierungen, hochwarmfest	Heat resistant nickel based alloys, high strength	2.4668	NiCr19Fe19NbMo	900-1400	Inconel 718 NiCr19Fe19Nb5Mo3
Kobalt-Chrom-Legierung	Cobalt chromium alloys					
H	Hartguss	Chilled cast iron		Ni-hard, Ampco	300-600 HB	Ni-hard, Ampco
	Gehärteter Stahl	Hardened steel			45-52 HRC	
					53-59 HRC	
					60-65 HRC	

Die angegebenen Schnittwerte sind Startwerte und müssen auf die vorhandenen Bedingungen abgestimmt werden.
The cutting data indicated are starting values and must be adjusted to the prevailing conditions.

	Schnittgeschwindigkeit Schichten Cutting speed Finishing				a_e Schichten Ebene Finishing plane	a_e Schichten Step (Kontur) Finishing step (Contour)
	Typ AF Type AF	Ø 12 $a_{p \max}$ f_z	Ø 16 $a_{p \max}$ f_z	Ø 20 $a_{p \max}$ f_z		
	280–300	0,30 0,25	0,30 0,25	0,40 0,25	d x 0,3 – d x 0,7	0,1–0,3
	280–300	0,30 0,25	0,30 0,25	0,40 0,25		
	240–260	0,30 0,25	0,30 0,25	0,40 0,25		
	280–300	0,30 0,25	0,30 0,25	0,40 0,25		
	220–240	0,30 0,25	0,30 0,25	0,40 0,25		
	200–220	0,30 0,25	0,30 0,25	0,40 0,25		
	240–260	0,30 0,20	0,30 0,20	0,40 0,20		
	280–360	0,30 0,20	0,30 0,20	0,40 0,20		
	220–240	0,30 0,20	0,30 0,25	0,40 0,25	d x 0,3 – d x 0,7	0,1–0,3
	220–240	0,30 0,20	0,30 0,25	0,40 0,25		
	240–260	0,30 0,25	0,30 0,25	0,40 0,25	d x 0,3 – d x 0,7	0,1–0,3
	220–240	0,30 0,25	0,30 0,25	0,40 0,25		
	240–280	0,30 0,25	0,30 0,25	0,40 0,25		
	240–280	0,30 0,25	0,30 0,25	0,40 0,25		
	80–100	0,30 0,25	0,30 0,25	0,40 0,25	d x 0,3 – d x 0,7	0,1–0,3
	60–80	0,30 0,20	0,30 0,20	0,40 0,20		
	120–140	0,30 0,20	0,30 0,25	0,40 0,25	d x 0,3 – d x 0,7	0,1–0,3
	240–260	0,20 0,20	0,30 0,25	0,40 0,25		
	160–180	0,15 0,15	0,25 0,20	0,25 0,22		
	100–120	0,15 0,15	0,25 0,20	0,25 0,22		

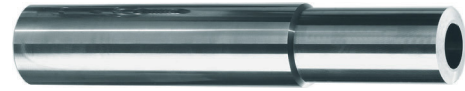
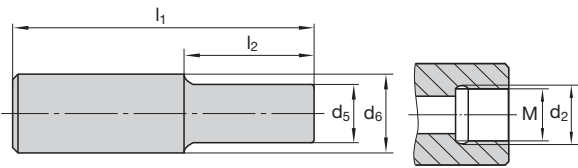

Katalog-Nr. Cat.-No.						ADT T	
M	l ₁	d ₂	d ₅	d ₆	l ₂	Ident No.	LMT-Code
6	140	6,5	9,7	10	53	6129285	ADT T06 140 RZ-C
6	110	6,5	9,7	10	38	6129286	ADT T06 110 RZ-C
6	162	6,5	11	12	52	6129287	ADT T06 162 RZ-C
6	122	6,5	11	12	37	6129288	ADT T06 122 RZ-C
8	177	8,5	13,8	16	57	6129289	ADT T08 177 RZ-C
8	142	8,5	13,8	16	42	6129290	ADT T08 142 RZ-C
10	194	10,5	18,2	20	78	6129291	ADT T10 194 RZ-C
10	144	10,5	18,2	20	54	6129292	ADT T10 144 RZ-C
12	210	12,5	22,6	25	90	6129293	ADT T12 210 RZ-C
12	160	12,5	22,6	25	60	6129294	ADT T12 160 RZ-C
16	232	17	28,6	32	99	6129295	ADT T16 232 RZ-C
16	182	17	28,6	32	59	6129296	ADT T16 182 RZ-C

Anschlussmaße und Berechnungen
Dimensions and calculations

Anschlussmaße Dimensions						
	d ₃	d ₂	d ₅	l ₁	l ₂	l ₄
M6	6,5	6,5	9,7	6,5	16	1,5
M8	8,5	8,5	13	6,5	19	1,5
M10	10,5	10,5	18	6,5	19	1,5
M12	12,5	12,5	21	7	25	2
M16	17	17	29	8	31	2
M20	21	21	36	8	37	2

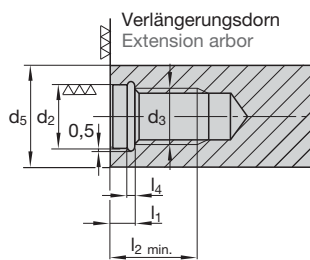

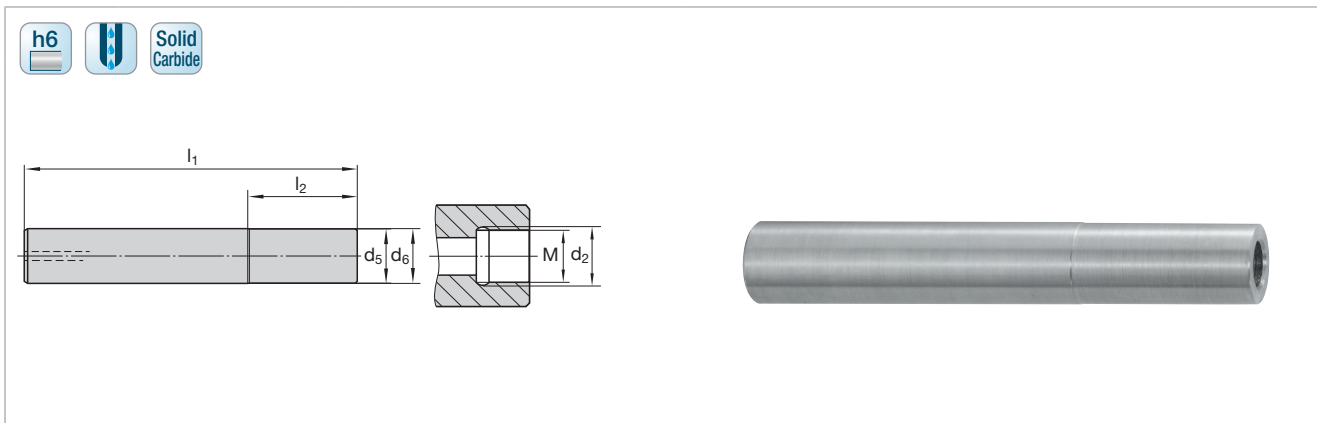

Katalog-Nr. Cat.-No.						ADT T	
M	l ₁	d ₂	d _{5-0,1}	d ₆	l ₂	Ident No.	LMT-Code
6	122	6,5	11,7	12	17	7022685	ADT T06 122 RZX-C-I
6	162	6,5	11,7	12	32	7022687	ADT T06 162 RZX-C-I
8	142	8,5	15,7	16	17	7022700	ADT T08 142 RZX-C-I
8	177	8,5	15,7	16	32	7022703	ADT T08 177 RZX-C-I
10	144	10,5	19,7	20	24	7022704	ADT T10 144 RZX-C-I
10	194	10,5	19,7	20	49	7022705	ADT T10 194 RZX-C-I

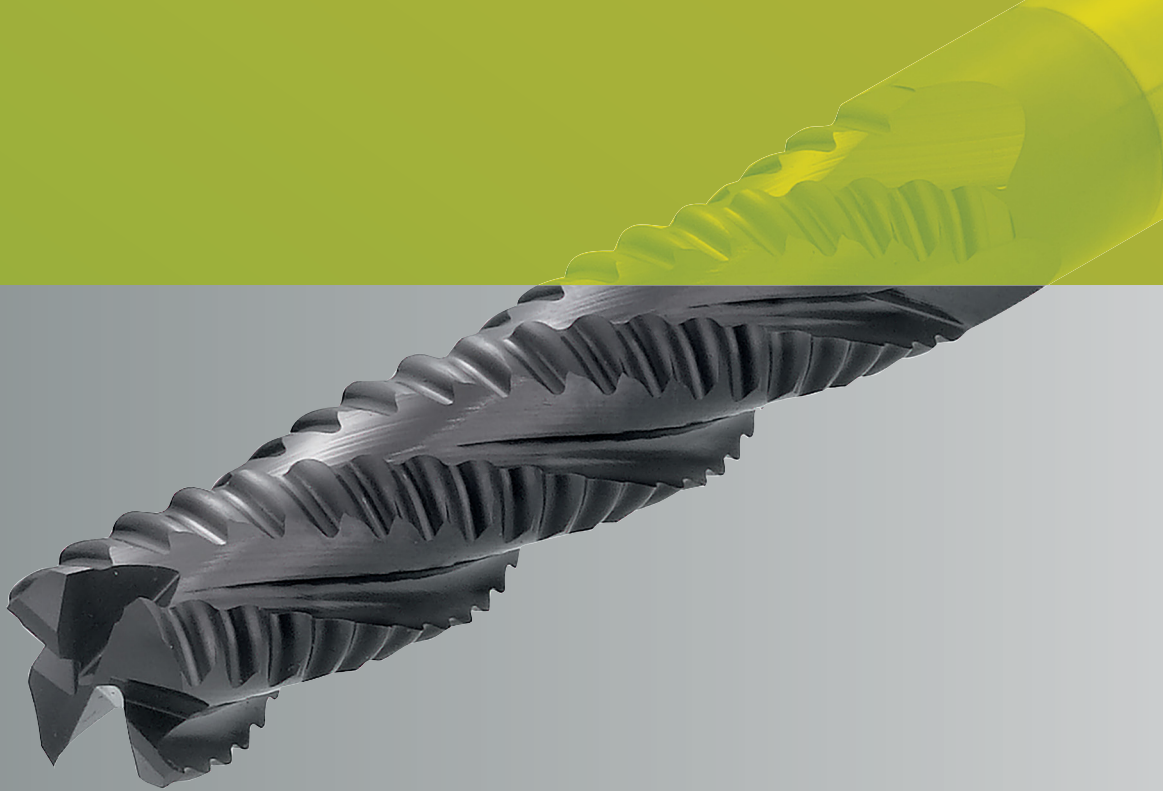

FRÄSEN

MIT HSS-E-PM, HSS-E
MILLING WITH
HSS-E-PM, HSS-E

Fräsen mit HSS-E-PM, HSS-E Milling with HSS-E-PM, HSS-E

170 **Auswahlübersicht**
Selection table

174 **Typenbeschreibungen**
Type descriptions

Schaftfräser, PM-Evolution

End mills, PM-Evolution

178 **PM-Evolution Schaftschrupfräser**
PM-Evolution roughing end mills

180 **PM-Evolution Bohrnutenfräser**
PM-Evolution slotting end mills

181 **PM-Evolution Tri-Cut Bohrnutenfräser**
PM-Evolution tri-cut slot drills

182 **PM-Evolution Schaftfräser**
PM-Evolution end mills

183 **PM-Evolution AIRline-Schaftfräser**
PM-Evolution AIRline end mills

184 **PM-Evolution Kugel-Kopierfräser**
PM-Evolution ball nose end mills

Walzenstirn- und Scheibenfräser, HSS-E Shell end mills and side milling cutters, HSS-E

189 **Walzenstirnfräser**
Shell end mills

Formfräser, HSS-E

Form milling cutters, HSS-E

192 **Formfräser für Kerbschlag-Biegeproben**
Form milling cutters for notched-bar impact samples

196 **Schaftfräser für T-Nuten DIN 650**
T-slot milling cutters to DIN 650

197 **Schlitzfräser für T-Nuten nach DIN 6888**
Passung P 9
Woodruff keyseat cutters for keyways to DIN 6888,
P 9 fit

Schnittwertempfehlungen finden Sie direkt nach jedem Produkt.
Please find cutting data recommendations right after each product.

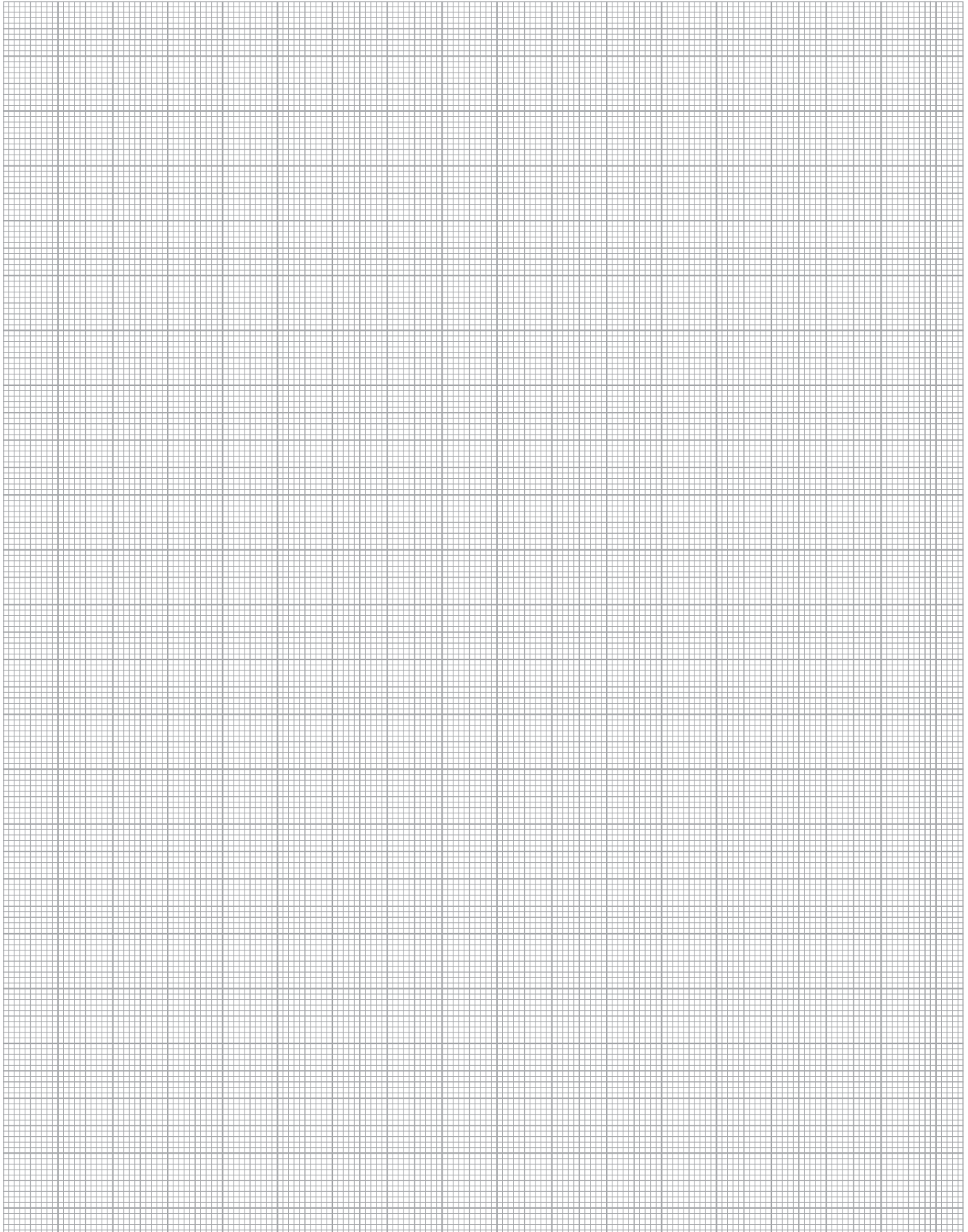

Tool Guide

Tool guide









1. Werkstoff Material

P	Stahl, Stahlguss, rostfreier Stahl, ferritisch und martensitisch Steel, cast steel, stainless steel, ferritic and martensitic
M	Rostfreier Stahl und Stahlguss, austenitisch und austenitisch/ferritisch Stainless steel and cast steel, austenitic and austenitic/ferritic
K	Grauguss, Sphäroguss, Temperguss Grey cast iron, cast iron with spheroidal graphite, malleable cast iron
N	Aluminium und andere Nichteisenmetalle, Kunststoffe, Graphit Aluminium and other non ferrous metals, plastic, graphite
S	Hochwarmfeste Stähle, Super- und Titanlegierungen High temperature alloys, super and titanium alloys
H	Gehärteter Stahl und Stahlguss Hardened steel and cast steel

2. Anwendung Application

Prozesse Processes	
 Schruppen Roughing	 Schruppen + Semischlichten Roughing + Semi finishing
 Semischlichten Semi finishing	 Schruppen + Schlichten Roughing + Finishing
 Schlichten Finishing	 Semischlichten + Schlichten Semi finishing + Finishing
 Planfräsen Face milling	 Nutenfräsen Slotting
 Kopierfräsen Copying	 Taschenfräsen Pocket milling
 Eckfräsen Corner milling	 Zirkularfräsen Circular milling
 Außenkonturfräsen Contour milling	 Trochoidalfräsen Trochoidal milling

3. Typ und Bezeichnung Type and explanation

 Hochpositiver Schlichtfräser für die Zerspänung von Nichteisenmetall/Kunststoffe Finishing end mills, high positiv, for milling of nonferrous metals/plastics
 Hochpositiver Schruppfräser für die Zerspänung von Nichteisenmetall/Kunststoffe Roughing end mills, high positiv, for milling of nonferrous metals/plastics
 Universal Schlichtfräser Universal finishing end mills
 Schlichtfräser mit hoher Drallsteigung zur Kantenbearbeitung Finishing end mills with high helix angle for side milling
 Schruppfräser mit rundem Spanteilerprofil Roughing end mills with round chip-breaker profil
 Schruppfräser mit flachem Spanteilerprofil Roughing end mills with shallow chip-breaker profil
 Schlichtfräser für die Bearbeitung von Werkzeugstählen und kurzspanenden Werkstoffen Finishing end mills for tool steel, tough and short chipping materials
 Schruppfräser mit feiner Teilung des runden Spanteilerprofils Roughing end mills with fine tooth round chip-breaker profil

Eine ausführliche Typenbeschreibung ab Seite 174
Detailed description of the types starting page 174

4. Katalognummernverzeichnis Index of catalog numbers siehe Seite see page 500

Auswahlübersicht HSS-E / PM-Fräser
Selection table HSS-E / PM-Cutters

Seite Page	Werkstoff Material						Prozess Process	Anwendung Application								Typ Type	Kat.-Nr. Cat.-No.	Drall- winkel Helix angle
	P	M	K	N	S	H												
178	■	■	■					■		■	■	□	□	□		NF	F515C	30°
179	■	□	■		■	□		■		■	■	■	■	■		HR	F519C	
180	■		□	■				□		□	□	■	■	■		N	F445	30°
180	■	□	■	■	□			□		□	□	■	■	■			F445C	
181	■	□	■	■	□			■		■	■	■	■	■			F406C	
182	■	□		□	■			■		■	■	□	□	□		SN	F523	40°
182	■	■	□	■	□			■		■	■	□	□	□			F523C	
183				■				■		■	■	■	■	■		AIRline SH	F524	20°
183				■				■		■	■	■	■	■		AIRline SHR	F525	
184	■	□	■	■	□				■		□		■			N	F454C	30°

■ = Hauptanwendung First choice
□ = Nebenanwendung Second choice

	Ø von-bis from-to	Ausführung Design				Zähne- zahl Number of tooth	Bohrungsdurchmesser Aufnahmedurchmesser Schaftdurchmesser Bore diameter Adapter diameter Shank diameter von-bis from-to	Stirn- geometrie Front geometry	Schaft nach DIN Shank (norm)	Beschichtung Coating		Seite Page
		XS	S	L	XL					unbeschichtet uncoated	beschichtet coated	
	6-25		●	●		3 / 4 / 5	6-25	SC			●	178
	6-25		●	●			6-25				●	179
	2-25		●			2	6-25	SC		●		180
			●								●	180
			●	●							●	181
	3-25		●	●		4	6-25			●		182
			●	●							●	182
	4-32		●	●		2 / 3	6-32	SC		●		183
			●	●						●		183
	2-20		●			2	6-20	BN			●	184

● = Standard Standard



Auswahlübersicht HSS-E / PM-Fräser
Selection table HSS-E / PM-Cutters

Seite Page	Werkstoff Material						Prozess Process	Anwendung Application								Typ Type	Kat.- Nr. Cat.- No.	Drallwinkel Helix angle	
	P	M	K	N	S	H													
189	■	□	□	□	□	□		■		■	■						SN	1013	40°
189	■	■	□	■	□	□		■		■	■							1013C	
189	■	□	□	□	□	□		■		■	■						NF	1015	30°
189	■	■	■	□	□	□		■		■	■							1015C	
189	■	□	□	□	□	□		■		■	■						NR	1016	
189	■	■	■	□	□	□		■		■	■							1016C	
192	■	□	□	□	□	□					■						-	1324A	-
196	■	□	□	□	□	□					■						N	1602	10° kreuzverzahnt staggered tooth
196	■	□	■	□	□	□					■							1602C	
197	■	□	□	□	□	□					■							1641	gerade verzahnt straight tooth

■ = Hauptanwendung First choice
□ = Nebenanwendung Second choice















	Ø von – bis from – to	Ausführung Design				Zähnezahl Number of tooth	Bohrungsdurchmesser Aufnahmedurchmesser Schaftdurchmesser Bore diameter Adapter diameter Shank diameter von – bis from – to	Stirn- geometrie Front geometry	Schaft nach DIN Shank (norm)	Beschichtung Coating		Seite Page
		XS	S	L	XL					unbeschichtet uncoated	beschichtet coated	
	40–80		●			8 / 10	16 / 22 / 27	SEM		●		189
											●	189
						6 / 8 / 10				●		189
											●	189
										●		189
											●	189
	75					18	27	–		●		192
	12,5–40					6 / 8	10–25	TS		●		196
											●	196
	10,5–45,5					8 / 10 / 12 / 14	6–12	WKC		●		197

● = Standard Standard

Fräsen mit HSS-E-PM, HSS-E
Milling with HSS-E-PM, HSS-E

Typenbeschreibungen HSS-E / PM-Fräser
Type descriptions HSS-E / PM-Cutters









	Typ Type	Typenbeschreibung	Type description	
	NF	PM-Evolution Schruppfräser mit flachem Spanteilerprofil auch zum Schlichten geeignet, Mehrschneider, kurz und lang, Schrupp-Schlichtverzahnung Großer Anwendungsbereich bei Werkstoffen mit mittlerer und hoher Festigkeit (< 1200 N/mm ²), z. B. Einsatz-, Vergütungsstähle, legierte Werkzeugstähle, sowie Gusseisen und Gusslegierungen	PM-Evolution roughing end mills with shallow chip-breaker profil also for finishing operations, multiple flutes, short and long, Roughing/finishing serration Large application range for materials with medium and high strength (< 1200 N/mm ²), e. g. case hardening/heat-treatable steel, cast iron and cast alloys	
	HR	PM-Evolution Schruppfräser, Mehrschneider, kurz und lang Feine Schrupp-Verzahnung Großer Anwendungsbereich bei Werkstoffen mit mittlerer bis hoher Festigkeit (ca. 900–1200 N/mm ²), z. B. Einsatz-, Vergütungsstähle, legierte Werkzeugstähle, sowie Gusseisen und Gusslegierungen	PM-Evolution roughing end mills, multiple flutes, short and long Fine roughing serration Large application range for materials with medium to high strength (approx. 900–1200 N/mm ²), e. g. case hardening/heat-treatable steel, cast iron and cast alloys	
	N	PM-Evolution Bohrnutenfräser, Zweischneider, kurz Bohren auf volle Tiefe und anschließendes Längsfräsen, enge und formgenaue Passungen durch Rahmenfräsen	PM-Evolution slotting end mills, 2-flute, short Drilling to full depth followed by straight milling, narrow and precise fits through frame milling	
	N	PM-Evolution Tri-Cut Bohrnutenfräser, Dreischneider, kurz und lang Bohren auf volle Tiefe und anschließendes Längsfräsen, enge und formgenaue Passungen durch Rahmenfräsen	PM-Evolution tri-cut slotting end mills, 3-flute, short and long Drilling to full depth followed by straight milling, narrow and precise fits through frame milling	
	SN	PM-Evolution Schaftfräser, Vierschneider, kurz und lang Zum Schlichten mit hoher Zerspanleistung bei gleichzeitig guter Oberfläche von Stählen mit mittlerer bis hoher Festigkeit, rost- und säurebeständige Stähle, bevorzugt Gleichlaufräsen	PM-Evolution end mills, 4-flute, short and long For finishing with high chip removal and simultaneous good surface of steel with medium to high strength, stainless and acid-resistant steel, preferably synchronous milling	
	SH	PM-Evolution AIRline-Schaftfräser, Zwei- und Dreischneider, kurz und lang Positive Span- und Freiwinkel bei scharf ausgeschliffenen Schneiden sorgen für geringe Schnittkräfte und gute Oberflächen. Bis zu 50 % höhere Zerspanleistung bei fast allen Nichteisenmetallen und Kunststoffen	PM-Evolution AIRline end mills, 2 and 3 flutes, short and long Positive rake and clearance angles with sharply ground cutting edges ensure low cutting effort and good surfaces. Up to 50 % higher chip removal for almost all non-ferrous metals and plastics	
	SHR	PM-Evolution AIRline-Schaftfräser, Zwei- und Dreischneider, kurz und lang Hochpositiv ausgeschliffene Mikroschneiden und hoher Freiwinkel. Schruppprofil speziell entwickelt für Nichteisenmetalle und Kunststoffe. Stirnschneiden für höchste Bohrvorschübe ausgelegt. Schräges Eintauchen möglich	PM-Evolution AIRline end mills, 2 and 3 flutes, short and long Highly positive ground micro cutting edges and high clearance angle. Roughing profile developed specially for non-ferrous metals and plastics. Front cutting edges designed for maximum drill feeds. Ramping possible	

	Stirngeometrie Front	DIN	Schneidstoffsorte Carbide Grade	Kat. Nr. Cat. No. unbeschichtet uncoated	Kat. Nr. Cat. No. beschichtet coated	Seite Page
		844 B			F515C	178
		844 B			F519C	179
		327 D		F445	F445C	180
		327 D 844 B		F406	F406C	181
		844 B		F523	F523C	182
		844 B		F524		183
		844 B		F525		183



Typenbeschreibungen HSS-E / PM-Fräser
Type descriptions HSS-E / PM-Cutters

	Typ Type	Typenbeschreibung	Type description	
	N	PM-Evolution Radiusfräser, Zweischneider, kurz Stirnseitig bis Mitte schneidend, HSS-E-PM, Bohren auf volle Tiefe und anschließendes Längsfräsen, besonders geeignet zum Kopierfräsen. Großer Anwendungsbereich bei Werkstoffen mittlerer Festigkeit	Ball nose end mills, 2-flute, short Cuts on the end face up to the center, HSS-E-PM, drilling to full depth followed by straight milling, especially suited for copy milling. Large application range for materials with medium strength	
	SN	Walzenstirn-Schlichtfräser Breiter Anwendungsbereich bei Werkstoffen mittlerer bis hoher Festigkeit, gut geeignet für rost- und säurebeständige Stähle, Titanlegierungen. Besonders geeignet für Gleichlaufräsen	Finishing shell end mills Wide application range for materials with medium to high strength, well suited for stainless and acid-resistant steel, titanium alloys, specially suited for synchronous milling	
	NF	Walzenstirn-Schrupp-Schlichtfräser mit Schrupp-Schlichtverzahnung Breiter Anwendungsbereich bei Werkstoffen mittlerer bis hoher Festigkeit (< 1100 N/mm ²), NE-Metalle und Gusslegierungen	Roughing/finishing shell end mills with Roughing/finishing serration Wide application range for materials with medium to high strength (< 1100 N/mm ²), non-ferrous metals and cast alloys	
	NR	Walzenstirn-Schruppfräser mit weiter Schruppverzahnung Breiter Anwendungsbereich bei Werkstoffen mittlerer bis hoher Festigkeit (< 900 N/mm ²), vorwiegend langspanend, sowie für Titan-Legierungen	Roughing shell end mills with wide roughing serration Wide application range for materials with medium to high strength (< 900 N/mm ²), mainly long chipping, and for titanium alloys	
		Formfräser für Kerbschlag-Biegeproben, radial-hinterschliffen für ISO-Spitzkerbprobe	Form milling cutters, for notched bar impact tests, radial relief ground for ISO-notch sample	
	N	Schafffräser für T-Nuten DIN 650, kreuzverzahnt	T-Slot milling cutters to DIN 650, staggered tooth	
	N	Schlitzfräser für Nuten nach DIN 6888, gerade verzahnt	Woodruff keyseat cutters for keyways to DIN 6888, straight tooth	

	Stirngeometrie Front	DIN	Schneidstoffsorte Carbide Grade	Kat. Nr. Cat. No. unbeschichtet uncoated	Kat. Nr. Cat. No. beschichtet coated	Seite Page
		327 D			F454C	184
	SEM	1880		1013	1013C	189
	SEM	1880		1015	1015C	189
	SEM	1880		1016	1016C	189
	-	Werksnorm Fette Standard		1324 A		192
	TS	851 AB		1602	1602C	196
	WKC	850 C		1641		197

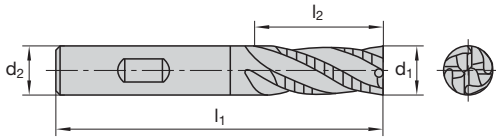

Katalog-Nr. Cat.-No.					F515C
P					■
M					■
K					■
N					
S					
H					
d ₁	l ₂	l ₁	d ₂	z	Ident No.
kurz short					
6	13	57	6	3	7009069
8	19	69	10	4	7009070
10	22	72	10	4	7009071
12	26	83	12	4	7009072
14	26	83	12	4	7009073
16	32	92	16	4	7009074
18	32	92	16	4	7009075
20	38	104	20	4	7009076
25 ¹⁾	45	121	25	5	7009078
lang long					
6	24	68	6	3	7009079
8	38	88	10	4	7009080
10	45	95	10	4	7009081
12	53	110	12	4	7009082
14	53	110	12	4	7009083
16	63	123	16	4	7009084
20	75	141	20	4	7009086
25 ¹⁾	90	166	25	5	7009087

¹⁾ mit Stirneindrehung
 with center bore

Schnittwertempfehlungen ab Seite 186
 Cutting data recommendations starting page 186

■ = Hauptanwendung First choice
 □ = Nebenanwendung Second choice

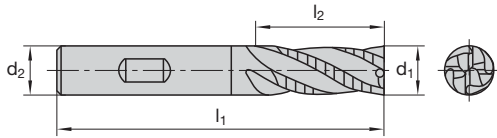

Katalog-Nr. Cat.-No.					F519C
P					■
M					□
K					■
N					■
S					■
H					□
d ₁	l ₂	l ₁	d ₂	z	Ident No.
kurz short					
6	13	57	6	3	7009088
8	19	69	10	3	7009089
10	22	72	10	4	7009090
12	26	83	12	4	7009091
14	26	83	12	4	7009092
16	32	92	16	4	7009093
20	38	104	20	4	7009094
25 ¹⁾	45	121	25	5	7009095

Fräsen mit HSS-E-PM, HSS-E
 Milling with HSS-E-PM, HSS-E

¹⁾ mit Stirneindrehung
 with center bore

Schnittwertempfehlungen ab Seite 186
 Cutting data recommendations starting page 186

■ = Hauptanwendung First choice
 □ = Nebenanwendung Second choice

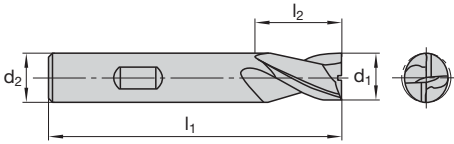

Katalog-Nr. Cat.-No.					F445	F445C
P					<input type="checkbox"/>	<input checked="" type="checkbox"/>
M					<input checked="" type="checkbox"/>	<input type="checkbox"/>
K					<input checked="" type="checkbox"/>	<input checked="" type="checkbox"/>
N					<input checked="" type="checkbox"/>	<input type="checkbox"/>
S					<input type="checkbox"/>	<input type="checkbox"/>
H						
d ₁	l ₂	l ₁	d ₂	z	Ident No.	Ident No.
kurz short						
2	4	48	6	2	7008865	7008880
3	5	49	6	2	7008866	7008881
4	7	51	6	2	7008867	7008882
5	8	52	6	2	7008868	7008883
6	8	52	6	2	7008869	7008884
7	10	60	10	2	7008870	-
8	11	61	10	2	7008871	7008886
10	13	63	10	2	7008872	7008887
12	16	73	12	2	7008873	7008888
14	16	73	12	2	7008874	7008889
16	19	79	16	2	7008875	7008890
18	19	79	16	2	7008876	-
20	22	88	20	2	7008877	7008892

Schnittwertempfehlungen ab Seite 186
Cutting data recommendations starting page 186

■ = Hauptanwendung First choice
□ = Nebenanwendung Second choice

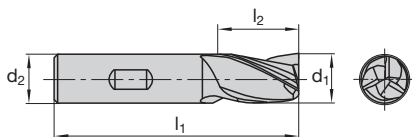

Katalog-Nr. Cat.-No.					F406C
P					■
M					□
K					■
N					□
S					□
H					
d ₁	l ₂	l ₁	d ₂	z	Ident No.
kurz short					
3	5	49	6	3	7008913
4	7	51	6	3	7008914
5	8	52	6	3	7008915
6	8	52	6	3	7008916
8	11	61	10	3	7008918
10	13	63	10	3	7008920
12	16	73	12	3	7008922
14	16	73	12	3	7008924
16	19	79	16	3	7008926
20	22	88	20	3	7008928
lang long					
3	8	52	6	3	7008943
4	11	55	6	3	7008944
5	13	57	6	3	7008945
6	13	57	6	3	7008946
7	16	66	10	3	7008947
8	19	69	10	3	7008948
10	22	72	10	3	7008949
12	26	83	12	3	7008950
16	32	92	16	3	7008952
20	38	104	20	3	7008954

Schnittwertempfehlungen ab Seite 186
Cutting data recommendations starting page 186

■ = Hauptanwendung First choice
□ = Nebenanwendung Second choice

Fräsen mit HSS-E-PM, HSS-E
Milling with HSS-E-PM, HSS-E

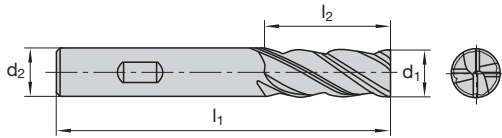

Katalog-Nr. Cat.-No.					F523	F523C
P					<input type="checkbox"/>	<input checked="" type="checkbox"/>
M					<input checked="" type="checkbox"/>	<input type="checkbox"/>
K					<input checked="" type="checkbox"/>	<input checked="" type="checkbox"/>
N					<input checked="" type="checkbox"/>	<input type="checkbox"/>
S					<input type="checkbox"/>	<input type="checkbox"/>
H					<input type="checkbox"/>	<input type="checkbox"/>
d ₁	l ₂	l ₁	d ₂	z	Ident No.	Ident No.
kurz short						
4	11	55	6	4	7008955	7008971
5	13	57	6	4	7008956	7008972
6	13	57	6	4	7008957	7008973
8	19	69	10	4	7008959	7008975
10	22	72	10	4	7008961	7008977
12	26	83	12	4	7008963	7008979
14	26	83	12	4	7008965	7008981
16	32	92	16	4	7008966	7008982
18	32	92	16	4	-	7008983
20	38	104	20	4	7008968	7008984
22	38	104	20	4	-	7008985
25	45	121	25	4	7008970	7008986
lang long						
3	12	56	6	4	7008987	7009000
4	19	63	6	4	7008988	7009001
5	24	68	6	4	7008989	7009002
6	24	68	6	4	7008990	7009003
8	38	88	10	4	7008991	7009004
10	45	95	10	4	7008992	7009005
12	53	110	12	4	7008993	7009006
14	53	110	12	4	7008994	7009007
16	63	123	16	4	7008995	7009008
20	75	141	20	4	7008997	7009010

Schnittwertempfehlungen ab Seite 186
Cutting data recommendations starting page 186

■ = Hauptanwendung First choice
□ = Nebenanwendung Second choice

Katalog-Nr. Cat.-No.					F524	F525 ¹⁾
P						
M						
K						
N				■	■	
S						
H						
d ₁	l ₂	l ₁	d ₂	z	Ident No.	Ident No.
kurz short						
4	11	55	6	2	7009128	-
5	13	57	6	2	7009129	-
6	13	57	6	2	7009130	-
8	19	69	10	2	7009131	-
10	22	72	10	2	7009132	7009146
12	26	83	12	3	7009133	7009147
14	26	83	12	3	7009134	7009148
16	32	92	16	3	7009135	7009149
20	38	104	20	3	7009137	7009151
lang long						
4	19	63	6	2	7009139	-
5	24	68	6	2	7009140	-
6	24	68	6	2	7009141	-
8	38	88	10	2	1121942	1121953
10	45	95	10	2	1121943	1121954
12	53	110	12	3	1121944	1121955
14	53	110	12	3	1121945	1121956
16	63	123	16	3	1121946	1121957
20	75	141	20	3	1121948	1121959
32	106	186	32	3	-	1121962

¹⁾ hinterschliffen
relief ground

Schnittwertempfehlungen ab Seite 186
Cutting data recommendations starting page 186

■ = Hauptanwendung First choice
□ = Nebenanwendung Second choice

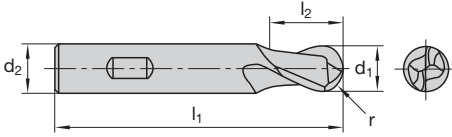

Katalog-Nr. Cat.-No.						F454C
P						■
M						□
K						■
N						■
S						□
H						
d ₁	l ₂	l ₁	d ₂	z	r ±0,02	Ident No.
kurz short						
2	4	48	6	2	1	7009013
3	5	49	6	2	1,5	7009014
4	7	51	6	2	2	7009015
5	8	52	6	2	2,5	7009016
6	8	52	6	2	3	7009017
8	11	61	10	2	4	7009018
10	13	63	10	2	5	7009019
12	16	73	12	2	6	7009020
16	19	79	16	2	8	7009021
20	22	88	20	2	10	7009022

Schnittwertempfehlungen ab Seite 186
Cutting data recommendations starting page 186

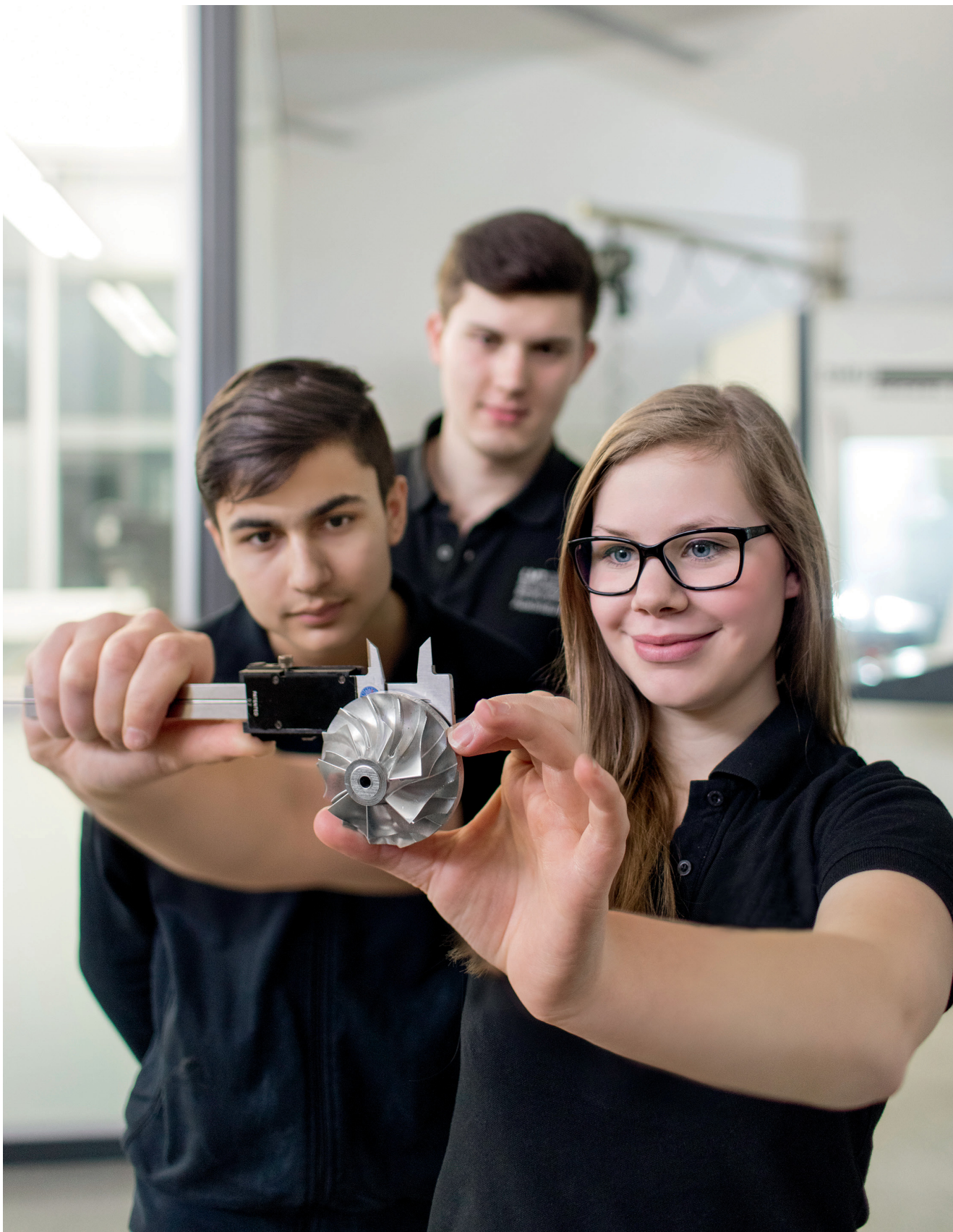

Fräsen mit HSS-E-PM, HSS-E
Milling with HSS-E-PM, HSS-E

Schnittwertempfehlungen für Schafffräser
Cutting data recommendations for end mills

	Werkstoff	Material	Werkstoff-Nr. Material No.	DIN Bezeichnung Alt DIN Description Old	R_m/UTS (N/mm²)	DIN Bezeichnung Neu DIN Description New
P	Unlegierter Baustahl + Automatenstahl	Plain carbon steel + free cutting steel	1.0570	St52-3	-700	S355J2G3
			1.1730	C45	-800	C45U
			1.0715	9SMn28	-700	11SMn30
			1.1191 1.7219	Ck45 26CrMo4	500-950	C45E 26CrMo4-2
	Vergütungsstahl, mittelfest	Heat-treatment steel, medium strength	1.7225 1.8159	42CrMo4 51CrV4	500-950	42CrMo4 51CrV4
	Stahlguss	Cast steel	1.0416	GS40	-950	GS40
	Einsatzstahl	Case hardening steel	1.7131	16MnCr5	-950	16MnCr5
	Rost- und säurebe- ständiger Stahl, ferritisch, martensitisch	Stainless steel, ferritic, martensitic	1.4006	X10Cr13	500-950	X12Cr13
			1.4104	X12CrMoS17		X14CrMoS17
			1.4122	X35CrMo17		X39CrMo17-1
	Vergütungsstahl, hochfest	Heat-treatment steel, high strength	1.7225	42CrMo4	950-1400	42CrMo4
			1.6580	30CrNiMo8		30CrNiMo8
	Nitrierstahl, vergütet	Nitriding steel, heat treated	1.8504	34CrAl6	950-1400	34CrAl6
			1.2344	X40CrMoV5.1		-900
	Werkzeugstahl	Tool steel	1.2343	X38CrMoV5 1	950-1400	X37CrMoV5-1
			1.2316	X38CrMo16		-1100
			1.2379	X155CrVMo12 1	-950	X153CrMoV12-1
1.2358			60CrMoV18-5	850-1000	60CrMoV18-5	
1.2080			X210Cr12	950-1400	X210Cr12	
1.2714			55NiCrMoV7	1100-1350	55NiCrMoV7	
1.2311			40CrMnMo7	-1100	40CrMnMo7	
1.2312 1.2738			40CrMnNiMoS8.6 45CrMnNiMo8.6.4	-1150 950-1150	40CrMnNiMoS8-6 45CrMnNiMo8-6-4	
M	Rost- und säurebe- ständiger Stahl, austenitisch	1.4301	X2CrNiMo17-12-2	500-950	X5CrNiMo18-10	
		1.4404	X6CrNiMoTi17-12-2		X2CrNiMo17-12-2	
		1.4571	X10CrNiMoTi18		X10CrNiMoTi18	
	Rost- und säurebe- ständiger Stahl, martensitisch aushärtbar	Stainless steel, martensitic steel	1.2709	X3NiCoMoTi18-9-5	800-1000	X3NiCoMoTi18-9-5
			1.4542 1.4568	X5CrNiCuNb16-4 X7CrNiAl17-7		X5CrNiCuNb16-4 X7CrNiAl17-7
K	Grauguss	Grey cast iron	0.6025	GG25	100-400 (120-260 HB)	EN-GJL-250
	Legierter Grauguss	Alloyed grey cast iron	0.6678	GGL-NiCr35 2	150-250 (160-230 HB)	EN-GJLA-XNiCr35-2
	Sphäroguss	Nodular cast iron	0.7060	GGG60	400-800	EN-GJS-600-3
			0.7070	GGG70L	(120-310 HB)	EN-GJS-700-2U
Temperguss	Malleable cast iron	0.8155	GTS55	350-700 (150-280 HB)	EN-GJMB-550-4	
N	Aluminium-Legierungen, kurzspanend	Aluminium alloys, short chipping	3.2581	G-AlSi12	-400	G-IGK-AlSi12
	Aluminium-Legierungen, langspanend	Aluminium alloys, long chipping	3.3535	AlMg3	-550	AlMg3
			3.4365	AlZnMgCu1,5		AlZnMgCu1,5
	Kupfer-Legierungen, kurzspanend	Copper alloys, short chipping	2.0402	MS58	-500	CuZn40Pb2
	Kupfer-Legierungen, langspanend	Copper alloys, long chipping	2.0320	MS63	300-500	CuZn37
			2.0975	CuAl10Ni		CuAl10Fe5Ni5-C
Duroplaste	Thermoplastics		PVC	40-70	PVC	
Duroplaste	Duroplastics		Bakelit, Melamin	20-40	Bakelit, Melamin	
S	Titan-Legierungen, mittelfest	Titanium alloys, medium strength	3.7115	TiAl5Sn2,5	-950	TiAl5Sn2-5
			3.7164	TiAl6V4		Ti6AlV4
	Titan-Legierungen, hochfest	Titanium alloys, high strength	3.7174	TiAl6Sn2	900-1400	TiAl6V6Sn2
	Nickelbasis-Legierungen, mittelfest	Nickel based alloys, medium strength	2.4670	NiCr12Al6MoNb	-950	NiCr12Al6MoNb
Nickelbasis-Legierungen, hochwarmfest	Heat resistant nickel based alloys, high strength	2.4668	NiCr19Fe19NbMo	900-1400	Inconel 718 NiCr19Fe19Nb5Mo3	
H	Hartguss	Chilled cast iron		Ni-hard, Ampco	300-600 HB	Ni-hard, Ampco

Bitte beachten Sie die Werkstoffempfehlung auf der jeweiligen Produktseite.
Please take notice of the material recommendation on each catalog page of the product.

Schnittgeschwindigkeitskorrekturfaktoren siehe Seite 188
Cutting speed correction factor see page 188

HSS-E-PM AL2Plus v_c (m/min)	Fräserdurchmesser Cutting diameter (mm)				
	Vorschub pro Zahn f_z bei Fräser-Ø Feed per tooth f_z for cutter diameter d_1 (mm)				
	6	8	12	20	32
90	0,052	0,065	0,09	0,12	0,15
90	0,052	0,065	0,09	0,12	0,15
70	0,045	0,06	0,09	0,12	0,15
60	0,045	0,065	0,09	0,12	0,15
45	0,04	0,052	0,075	0,11	0,12
60	0,052	0,065	0,09	0,11	0,15
20-35	0,045	0,065	0,09	0,12	0,15
40	0,04	0,052	0,075	0,10	0,12
40	0,04	0,052	0,075	0,10	0,12
35	0,04	0,052	0,075	0,10	0,12
19-35	0,052	0,065	0,09	0,12	0,15
45	0,052	0,065	0,09	0,12	0,15
50-70	0,078	0,09	0,12	0,15	0,20
60	0,045	0,065	0,09	0,12	0,15
60	0,052	0,065	0,09	0,12	0,15
90	0,052	0,065	0,09	0,12	0,15
140	0,026	0,04	0,06	0,12	0,15
450	0,026	0,04	0,075	0,12	0,15
90	0,015	0,03	0,05	0,09	0,11
120	0,022	0,03	0,07	0,11	0,15
180	0,026	0,04	0,06	0,11	0,14
120	0,026	0,04	0,06	0,12	0,14
30	0,016	0,024	0,05	0,08	0,10
20-30	0,01	0,018	0,03	0,06	0,07
40	0,048	0,06	0,10	0,12	0,15
6-8	0,028	0,034	0,075	0,09	0,11
25	0,040	0,052	0,075	0,12	0,12

Die angegebenen Schnittwerte sind Startwerte und müssen auf die vorhandenen Bedingungen abgestimmt werden.
The cutting data indicated are starting values and must be adjusted to the prevailing conditions.

Schnittgeschwindigkeitskorrektur f_1 Cutting speed correction factor f_1		
	beschichtet coated	unbeschichtet uncoated
$f_1 =$	1	0,6

Vorschubkorrektur f_2 Cutting speed correction factor f_2					
	Fräser mit Schlicht-Profil Milling cutters with finishing-profile	Fräser mit Schrupp-Profil Milling Cutters with roughing-profile	Bohrnutenfräser Slotting end mills		
Schafffräser End mills					
	$a_e = 0,1 \cdot d_1$ $a_p \leq 2 \cdot d_1$	$a_e \leq 0,5 \cdot d_1$ $a_p \leq 1 \cdot d_1$	$a_e = 1 \cdot d_1$ $a_p \leq 1 \cdot d_1$	I. Bohren Slotting $z = 2$	II. Fräsen Milling $z = 3$
$f_2 =$	1,0	0,8	0,5	0,3	0,6 0,7
Walzenstirnfräser Shell end mills					
	$a_e = 0,1 \cdot d_1$ $a_p \leq 0,05 \cdot d_1$	$a_e \leq 0,2 \cdot d_1$ $a_p \leq 0,05 \cdot d_1$	$a_e = 0,75 \cdot d_1$ $a_p \leq 0,05 \cdot d_1$		
$f_2 =$	1,0	0,5	1,0		

Drehzahl Speed	Vorschubgeschwindigkeit Feed rate	Zeitspanvolumen Chip removal rate	Spindelleistung Drive power
$n = \frac{v_c \cdot 1000}{\pi \cdot d_1} \cdot f_1$	$v_f = f_z \cdot z \cdot n \cdot f_2$	$Q = \frac{a_e \cdot a_p \cdot v_f}{1000}$	$P_e \approx \frac{Q}{LF}$

a_e = Schnittbreite Width of cut (mm)
 a_p = Schnitttiefe Depth of cut (mm)
 d_1 = Durchmesser Cutter diameter (mm)
 f_1 = Korrekturfaktor Correction factor (v_c)
 f_2 = Korrekturfaktor Correction factor (v_f)
 f_z = Vorschub pro Zahn Feed per tooth (mm)
 LF = Leistungsfaktor Efficiency factor (cm³/min/kW)

n = Drehzahl Speed (min⁻¹)
 P_e = Spindelleistung Drive power (kW)
 Q = Zeitspanvolumen Chip removal rate (cm³/min)
 v_c = Schnittgeschwindigkeit Cutting speed (m/min)
 v_f = Vorschubgeschwindigkeit Feed rate (mm/min)
 z = Anzahl der Schneiden No. of teeth

DIN
1880

40°

0,25/
-0,15

Katalog-Nr. Cat.-No.				1013	1013C
P				■	■
M				□	■
K					□
N				□	■
S					□
H					
d ₁	b ₁	d ₂	z	Ident No.	Ident No.
40	32	16	8	7009104	7009108
50	36	22	8	7009105	7009109
63	40	27	8	7009106	7009110
80	45	27	10	7009107	7009111

 Fräsen mit HSS-E-PM, HSS-E
Milling with HSS-E-PM, HSS-E

DIN
1880

30°

0,25/
-0,15

NF

NF

NR

NR

Katalog-Nr. Cat.-No.				1015	1015C	1016	1016C
P				■	■	■	■
M				□	■	□	■
K				□	■	□	■
N					□		□
S					□		
H							
d ₁	b ₁	d ₂	z	Ident No.	Ident No.	Ident No.	Ident No.
40	32	16	6	7009120	7009124	7009112	7009116
50	36	22	8	7009121	7009125	7009113	7009117
63	40	27	8	7009122	7009126	7009114	7009118
80	45	27	10	7009123	7009127	7009115	7009119

Schnittwertempfehlungen ab Seite 190
Cutting data recommendations starting page 190

■ = Hauptanwendung First choice
□ = Nebenanwendung Second choice

Schnittwertempfehlungen für Walzenstirnfräser
Cutting data recommendations for shell end mills

	Werkstoff	Material	Werkstoff-Nr. Material No.	DIN Bezeichnung Alt DIN Description Old	R_m/UTS (N/mm²)	DIN Bezeichnung Neu DIN Description New
P	Unlegierter Baustahl + Automatenstahl	Plain carbon steel + free cutting steel	1.0570	St52-3	-700	S355J2G3
			1.1730	C45	-800	C45U
			1.0715	9SMn28	-700	11SMn30
			1.1191 1.7219	Ck45 26CrMo4	500-950	C45E 26CrMo4-2
	Vergütungsstahl, mittelfest	Heat-treatment steel, medium strength	1.7225 1.8159	42CrMo4 51CrV4	500-950	42CrMo4 51CrV4
	Stahlguss	Cast steel	1.0416	GS40	-950	GS40
	Einsatzstahl	Case hardening steel	1.7131	16MnCr5	-950	16MnCr5
	Rost- und säurebe- ständiger Stahl, ferritisch, martensitisch	Stainless steel, ferritic, martensitic	1.4006	X10Cr13	500-950	X12Cr13
			1.4104	X12CrMoS17		X14CrMoS17
			1.4122	X35CrMo17		X39CrMo17-1
	Vergütungsstahl, hochfest	Heat-treatment steel, high strength	1.7225 1.6580	42CrMo4 30CrNiMo8	950-1400	42CrMo4 30CrNiMo8
			Nitrierstahl, vergütet	Nitriding steel, heat treated	1.8504 1.2344	34CrAl6 X40CrMoV5.1
	Werkzeugstahl	Tool steel			1.2343	X38CrMoV5 1
			1.2316	X38CrMo16	-1100	X38CrMo16
			1.2379	X155CrVMo12 1	-950	X153CrMoV12-1
			1.2358	60CrMoV18-5	850-1000	60CrMoV18-5
1.2080			X210Cr12	950-1400	X210Cr12	
1.2714			55NiCrMoV7	1100-1350	55NiCrMoV7	
1.2311			40CrMnMo7	-1100	40CrMnMo7	
1.2312 1.2738			40CrMnNiMoS8.6 45CrMnNiMo8.6.4	-1150 950-1150	40CrMnNiMoS8-6 45CrMnNiMo8-6-4	
M	Rost- und säurebe- ständiger Stahl, austenitisch	1.4301	X2CrNiMo17-12-2	500-950	X5CrNiMo18-10	
		1.4404	X6CrNiMoTi17-12-2		X2CrNiMo17-12-2	
		1.4571	X10CrNiMoTi18		X10CrNiMoTi18	
	Rost- und säurebe- ständiger Stahl, martensitisch aushärtbar	Stainless steel, martensitic steel	1.2709	X3NiCoMoTi18-9-5	800-1000	X3NiCoMoTi18-9-5
1.4542			X5CrNiCuNb16-4		X5CrNiCuNb16-4	
1.4568			X7CrNiAl17-7		X7CrNiAl17-7	
K	Grauguss	Grey cast iron	0.6025	GG25	100-400 (120-260 HB)	EN-GJL-250
	Legierter Grauguss	Alloyed grey cast iron	0.6678	GGL-NiCr35 2	150-250 (160-230 HB)	EN-GJLA-XNiCr35-2
	Sphäroguss	Nodular cast iron	0.7060	GGG60	400-800	EN-GJS-600-3
			0.7070	GGG70L	(120-310 HB)	EN-GJS-700-2U
Temperguss	Malleable cast iron	0.8155	GTS55	350-700 (150-280 HB)	EN-GJMB-550-4	
N	Aluminium-Legierungen, kurzspanend	Aluminium alloys, short chipping	3.2581	G-AlSi12	-400	G-IGK-AlSi12
	Aluminium-Legierungen, langspanend	Aluminium alloys, long chipping	3.3535	AlMg3	-550	AlMg3
			3.4365	AlZnMgCu1,5		AlZnMgCu1,5
	Kupfer-Legierungen, kurzspanend	Copper alloys, short chipping	2.0402	MS58	-500	CuZn40Pb2
	Kupfer-Legierungen, langspanend	Copper alloys, long chipping	2.0320	MS63	300-500	CuZn37
			2.0975	CuAl10Ni		CuAl10Fe5Ni5-C
Thermoplaste	Thermoplastics		PVC	40-70	PVC	
Duroplaste	Duroplastics		Bakelit, Melamin	20-40	Bakelit, Melamin	
S	Titan-Legierungen, mittelfest	Titanium alloys, medium strength	3.7115	TiAl5Sn2,5	-950	TiAl5Sn2-5
			3.7164	TiAl6V4		Ti6AlV4
	Titan-Legierungen, hochfest	Titanium alloys, high strength	3.7174	TiAl6Sn2	900-1400	TiAl6V6Sn2
	Nickelbasis-Legierungen, mittelfest	Nickel based alloys, medium strength	2.4670	NiCr12Al6MoNb	-950	NiCr12Al6MoNb
Nickelbasis-Legierungen, hochwarmfest	Heat resistant nickel based alloys, high strength	2.4668	NiCr19Fe19NbMo	900-1400	Inconel 718 NiCr19Fe19Nb5Mo3	

Schnittgeschwindigkeitskorrekturfaktoren siehe Seite 188
Cutting speed correction factor see page 188

	unbeschichtet uncoated	HSS-E AL2Plus v_c (m/min)	Fräserdurchmesser Cutting diameter (mm)			
			Vorschub pro Zahn f_z bei Fräser-Ø Feed per tooth f_z for cutter diameter d_1 (mm)			
			40	50	63	80
45	60	0,16	0,18	0,20	0,22	
45	60	0,16	0,18	0,20	0,22	
40	50	0,12	0,14	0,15	0,17	
40	50	0,12	0,14	0,15	0,17	
35	45	0,10	0,11	0,12	0,13	
45	55	0,15	0,16	0,18	0,20	
20	30	0,12	0,14	0,15	0,17	
25	35	0,10	0,11	0,12	0,13	
25	35	0,10	0,11	0,12	0,13	
25	35	0,10	0,11	0,12	0,13	
30	40	0,12	0,14	0,15	0,17	
25	40-60	0,15	0,16	0,18	0,20	
40	50	0,15	0,16	0,18	0,20	
40	50	0,15	0,16	0,18	0,20	
55	70	0,15	0,16	0,18	0,20	
90	120	0,12	0,14	0,15	0,17	
350	400	0,12	0,14	0,15	0,17	
60	75	0,11	0,13	0,14	0,15	
75	100	0,15	0,16	0,18	0,20	
130	160	0,12	0,14	0,15	0,17	
80	100	0,10	0,11	0,12	0,13	
16	25	0,09	0,10	0,11	0,12	
8	12	0,06	0,07	0,08	0,09	
12	20	0,10	0,11	0,12	0,13	
8	10	0,08	0,09	0,10	0,11	

Fräsen mit HSS-E-PM, HSS-E
Milling with HSS-E-PM, HSS-E

Die angegebenen Schnittwerte sind Startwerte und müssen auf die vorhandenen Bedingungen abgestimmt werden.
The cutting data indicated are starting values and must be adjusted to the prevailing conditions.

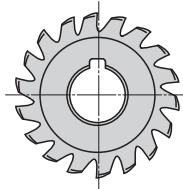
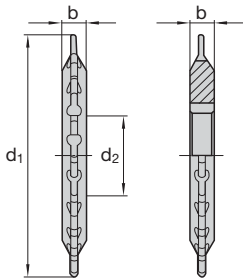

Katalog-Nr. Cat.-No.	1324A
P	<input checked="" type="checkbox"/>
M	<input type="checkbox"/>
K	<input type="checkbox"/>
N	<input type="checkbox"/>
S	
H	
	Ident No.
Für ISO-Spitzkerbprobe (ISO/V) nach DIN 50115 Shapi (V/Notch Probe), ASTM A 370 ISO/DIS 148, BS 131/Teil 2 Fräserwinkel 45°; Spitzenradius R 0,25 mm Baumaß 75 x 8 x 27 mm – Z = 18 For ISO V-Notch sample (ISO/V) to DIN 50115 Shapi (V/Notch Sample), ASTM A 370 ISO/DIS 148, BS 131/Part 2 Cutter angle 45°; Crest Radius R 0,25 mm Dimension 75 x 8 x 27 mm – Z = 18	1103612

Schnittwertempfehlungen ab Seite 194
Cutting data recommendations starting page 194

■ = Hauptanwendung First choice
□ = Nebenanwendung Second choice

Schnittgeschwindigkeitskorrektur f_1 Cutting speed correction factor f_1		
	beschichtet coated	unbeschichtet uncoated
$f_1 =$	1,0	0,8

Schnittgeschwindigkeitskorrektur f_1 /Vorschubkorrektur f_2 für Kerbschlag-Biegeproben Fräser Cutting speed correction factor f_1 /Feed rate correction factor f_2 for notched-bar impact test milling cutters						
Modul m Module m (mm)	1	3	5	10	20	>30
Teilung T Pitch T (mm)	2,5	10	20	30	-	-
$f_1 =$	1	1	0,9	0,85	0,6	0,5
$f_2 =$	1	1	1	1,2	1,5	1,5

Vorschubkorrektur f_2 Cutting speed correction factor f_2	
Scheibenfräser, kreuzverzahnt Side milling cutters, staggered tooth	Kerbschlag-Biegeprobenfräser Notched-bar impact tests milling cutters
$f_2 =$ 0,5	siehe oben see above

Drehzahl Speed	Vorschubgeschwindigkeit Feed rate	Zeitspanvolumen Chip removal rate	Spindelleistung Drive power
$n = \frac{v_c \cdot 1000}{\pi \cdot d_1} \cdot f_1$	$v_f = f_z \cdot z \cdot n \cdot f_2$	$Q = \frac{a_e \cdot a_p \cdot v_f}{1000}$	$P_e \approx \frac{Q}{LF}$

a_e = Schnittbreite Width of cut (mm)
 a_p = Schnitttiefe Depth of cut (mm)
 d_1 = Durchmesser Cutter diameter (mm)
 f_1 = Korrekturfaktor Correction factor (v_c)
 f_2 = Korrekturfaktor Correction factor (v_f)
 f_z = Vorschub pro Zahn Feed per tooth (mm)
 LF = Leistungsfaktor Efficiency factor (cm³/min/kW)

n = Drehzahl Speed (min⁻¹)
 P_e = Spindelleistung Drive power (kW)
 Q = Zeitspanvolumen Chip removal rate (cm³/min)
 v_c = Schnittgeschwindigkeit Cutting speed (m/min)
 v_f = Vorschubgeschwindigkeit Feed rate (mm/min)
 z = Anzahl der Schneiden No. of teeth

Fräsen mit HSS-E-PM, HSS-E
Milling with HSS-E-PM, HSS-E

Schnittwertempfehlungen für Scheibenfräser und Formfräser
Cutting data recommendations for side milling cutters and form milling cutters

	Werkstoff	Material	Werkstoff-Nr. Material No.	DIN Bezeichnung Alt DIN Description Old	R_m/UTS (N/mm²)	DIN Bezeichnung Neu DIN Description New
P	Unlegierter Baustahl + Automatenstahl	Plain carbon steel + free cutting steel	1.0570	St52-3	-700	S355J2G3
			1.1730	C45	-800	C45U
			1.0715	9SMn28	-700	11SMn30
			1.1191	Ck45	500-950	C45E
			1.7219	26CrMo4	500-950	26CrMo4-2
	Vergütungsstahl, mittelfest	Heat-treatment steel, medium strength	1.7225	42CrMo4	500-950	42CrMo4
			1.8159	51CrV4		51CrV4
	Stahlguss	Cast steel	1.0416	GS40	-950	GS40
	Einsatzstahl	Case hardening steel	1.7131	16MnCr5	-950	16MnCr5
			1.4006	X10Cr13	500-950	X12Cr13
				X12CrMoS17		X14CrMoS17
	Rost- und säurebe- ständiger Stahl, ferritisch, martensitisch	Stainless steel, ferritic, martensitic	1.4122	X35CrMo17		X39CrMo17-1
			1.7225	42CrMo4	950-1400	42CrMo4
			1.6580	30CrNiMo8		30CrNiMo8
	Vergütungsstahl, hochfest	Heat-treatment steel, high strength	1.8504	34CrAl6	950-1400	34CrAl6
			1.2344	X40CrMoV5.1	-900	X40CrMoV5-1
	Nitrierstahl, vergütet	Nitriding steel, heat treated	1.2343	X38CrMoV5 1	950-1400	X37CrMoV5-1
1.2316			X38CrMo16	-1100	X38CrMo16	
Werkzeugstahl	Tool steel	1.2379	X155CrVMo12 1	-950	X153CrMoV12-1	
		1.2358	60CrMoV18-5	850-1000	60CrMoV18-5	
		1.2080	X210Cr12	950-1400	X210Cr12	
		1.2714	55NiCrMoV7	1100-1350	55NiCrMoV7	
		1.2311	40CrMnMo7	-1100	40CrMnMo7	
		1.2312	40CrMnNiMoS8.6	-1150	40CrMnNiMoS8-6	
		1.2738	45CrMnNiMo8.6.4	950-1150	45CrMnNiMo8-6-4	
M	Rost- und säurebe- ständiger Stahl, austenitisch	Stainless steel, austenitic	1.4301	X2CrNiMo17-12-2	500-950	X5CrNiMo18-10
			1.4404	X6CrNiMoTi17-12-2		X2CrNiMo17-12-2
			1.4571	X10CrNiMoTi18		X10CrNiMoTi18
	Rost- und säurebe- ständiger Stahl, martensitisch aushärtbar	Stainless steel, martensitic steel	1.2709	X3NiCoMoTi18-9-5	800-1000	X3NiCoMoTi18-9-5
1.4542			X5CrNiCuNb16-4	X5CrNiCuNb16-4		
1.4568	X7CrNiAl17-7		X7CrNiAl17-7			
K	Grauguss	Grey cast iron	0.6025	GG25	100-400 (120-260 HB)	EN-GJL-250
			0.6678	GGL-NiCr35 2	150-250 (160-230 HB)	EN-GJLA-XNiCr35-2
	Sphäroguss	Nodular cast iron	0.7060	GGG60	400-800	EN-GJS-600-3
			0.7070	GGG70L	(120-310 HB)	EN-GJS-700-2U
Temperguss	Malleable cast iron	0.8155	GTS55	350-700 (150-280 HB)	EN-GJMB-550-4	
N	Aluminium-Legierungen, kurzspanend	Aluminium alloys, short chipping	3.2581	G-AlSi12	-400	G-IGK-AlSi12
	Aluminium-Legierungen, langspanend	Aluminium alloys, long chipping	3.3535	AlMg3	-550	AlMg3
			3.4365	AlZnMgCu1,5		AlZnMgCu1,5
	Kupfer-Legierungen, kurzspanend	Copper alloys, short chipping	2.0402	MS58	-500	CuZn40Pb2
	Kupfer-Legierungen, langspanend	Copper alloys, long chipping	2.0320	MS63	300-500	CuZn37
			2.0975	CuAl10Ni		CuAl10Fe5Ni5-C
Thermoplaste	Thermoplastics		PVC	40-70	PVC	
Duroplaste	Duroplastics		Bakelit, Melamin	20-40	Bakelit, Melamin	
S	Titan-Legierungen, mittelfest	Titanium alloys, medium strength	3.7115	TiAl5Sn2,5	-950	TiAl5Sn2-5
			3.7164	TiAl6V4		Ti6AlV4
	Titan-Legierungen, hochfest	Titanium alloys, high strength	3.7174	TiAl6Sn2	900-1400	TiAl6V6Sn2
	Nickelbasis-Legierungen, mittelfest	Nickel based alloys, medium strength	2.4670	NiCr12Al6MoNb	-950	NiCr12Al6MoNb
2.4668			NiCr19Fe19NbMo	900-1400	Inconel 718 NiCr19Fe19Nb5Mo3	

Schnittgeschwindigkeitskorrekturfaktoren siehe Seite 193
 Cutting speed correction factor see page 193

Formfräser Form milling	
v_c (m/min)	f_z (mm)
45	0,07
45	0,07
36	0,06
36	0,06
25	0,05
45	0,05
20	0,03
25	0,03
16	0,03
16	0,03
28	0,03
28	0,03
36	0,08
28	0,06
45	0,06
56	0,06
90	0,06
355	0,07
56	0,06
45	0,08
150	0,07
90	0,08
22	0,04
10	0,03
25	0,06
12	0,04

Fräsen mit HSS-E-PM, HSS-E
Milling with HSS-E-PM, HSS-E

Die angegebenen Schnittwerte sind Startwerte und müssen auf die vorhandenen Bedingungen abgestimmt werden.
The cutting data indicated are starting values and must be adjusted to the prevailing conditions.

Katalog-Nr. Cat.-No.							1602	1602C
P							■	■
M							□	□
K							□	■
N							□	□
S								
H								
d ₁	b	für T-Nuten for T-slots	d ₃	l ₁	d ₂	z	Ident No.	Ident No.
12,5	6	6	5	57	10	6	7008620	7008642
16	8	8	6,5	62	10	6	7008621	7008643
18	8	10	8	70	12	6	7008622	7008644
19	9	10	8	71	12	6	7008623	7008645
21	9	12	10	74	12	6	7008624	7008646
22	10	12	10	75	12	6	7008625	7008647
25	11	14	12	82	16	6	7008626	7008648
28	12	16	13	83	16	6	7008627	7008649
32	14	18	15	90	16	8	7008628	7008650
36	16	20	17	103	25	8	7008629	7008651
40	18	22	19	108	25	8	7008630	7008652

Schnittwertempfehlungen ab Seite 198
Cutting data recommendations starting page 198

■ = Hauptanwendung First choice
□ = Nebenanwendung Second choice

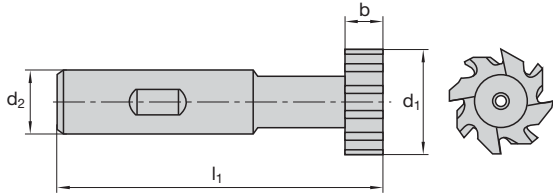

Katalog-Nr. Cat.-No.						1641
P						■
M						□
K						□
N						□
S						
H						
d ₁	b	Für Scheibenfedern For woodruff key	l ₁	d ₂	z	Ident No.
10,5	2	2 x 3,7	50	6	8	7008592
10,5	3	3 x 3,7	50	6	8	7008593
13,5	3	3 x 5	56	10	8	7008594
13,5	4	4 x 5	56	10	8	7008595
16,5	3	3 x 6,5	56	10	8	7008596
16,5	4	4 x 6,5	56	10	8	7008597
16,5	5	5 x 6,5	56	10	8	7008598
19,5	4	4 x 7,5	63	10	8	7008599
19,5	5	5 x 7,5	63	10	8	7008600
19,5	6	6 x 7,5	63	10	8	7008601
22,5	5	5 x 9	63	10	10	7008602
22,5	6	6 x 9	63	10	10	7008603
22,5	8	8 x 9	63	10	10	7008604
25,5	6	6 x 10	63	10	10	7008605
28,5	6	6 x 11	63	10	10	7008606
28,5	8	8 x 11	63	10	10	7008607
28,5	10	10 x 11	71	12	10	7008608
32,5	8	8 x 13	71	12	12	7008609
32,5	10	10 x 13	71	12	12	7008610
45,5	10	10 x 16	71	12	14	7008611

Fräsen mit HSS-E-PM, HSS-E
Milling with HSS-E-PM, HSS-E

Schnittwertempfehlungen ab Seite 198
Cutting data recommendations starting page 198

■ = Hauptanwendung First choice
□ = Nebenanwendung Second choice

Schnittwertempfehlungen für Formfräser mit Schaft

Cutting data recommendations for form milling cutters with shank

				DIN Bezeichnung Alt DIN Description Old	R _m /UTS (N/mm ²)	DIN Bezeichnung Neu DIN Description New
	Werkstoff	Material	Werkstoff-Nr. Material No.			
P	Unlegierter Baustahl + Automatenstahl	Plain carbon steel + free cutting steel	1.0570	St52-3	-700	S355J2G3
			1.1730	C45	-800	C45U
			1.0715	9SMn28	-700	11SMn30
			1.1191	Ck45	500-950	C45E
			1.7219	26CrMo4	500-950	26CrMo4-2
	Vergütungsstahl, mittelfest	Heat-treatment steel, medium strength	1.7225	42CrMo4	500-950	42CrMo4
	Stahlguss	Cast steel	1.8159	51CrV4		51CrV4
			1.0416	GS40	-950	GS40
	Einsatzstahl	Case hardening steel	1.7131	16MnCr5	-950	16MnCr5
	Rost- und säurebe- ständiger Stahl, ferritisch, martensitisch	Stainless steel, ferritic, martensitic	1.4006	X10Cr13	500-950	X12Cr13
			1.4104	X12CrMoS17		X14CrMoS17
			1.4122	X35CrMo17		X39CrMo17-1
	Vergütungsstahl, hochfest	Heat-treatment steel, high strength	1.7225	42CrMo4	950-1400	42CrMo4
			1.6580	30CrNiMo8		30CrNiMo8
	Nitrierstahl, vergütet	Nitriding steel, heat treated	1.8504	34CrAl6	950-1400	34CrAl6
			1.2344	X40CrMoV5.1	-900	X40CrMoV5-1
	Werkzeugstahl	Tool steel	1.2343	X38CrMoV5 1	950-1400	X37CrMoV5-1
1.2316			X38CrMo16	-1100	X38CrMo16	
1.2379			X155CrVMo12 1	-950	X153CrMoV12-1	
1.2358			60CrMoV18-5	850-1000	60CrMoV18-5	
1.2080			X210Cr12	950-1400	X210Cr12	
1.2714			55NiCrMoV7	1100-1350	55NiCrMoV7	
1.2311			40CrMnMo7	-1100	40CrMnMo7	
1.2312			40CrMnNiMoS8.6	-1150	40CrMnNiMoS8-6	
1.2738			45CrMnNiMo8.6.4	950-1150	45CrMnNiMo8-6-4	
M			Rost- und säurebe- ständiger Stahl, austenitisch	Stainless steel, austenitic	1.4301	X2CrNiMo17-12-2
	1.4404	X6CrNiMoTi17-12-2				X2CrNiMo17-12-2
	1.4571	X10CrNiMoTi18				X10CrNiMoTi18
	Rost- und säurebe- ständiger Stahl, martensitisch aushärtbar	Stainless steel, martensitic steel	1.2709	X3NiCoMoTi18-9-5	800-1000	X3NiCoMoTi18-9-5
			1.4542	X5CrNiCuNb16-4		X5CrNiCuNb16-4
1.4568	X7CrNiAl17-7		X7CrNiAl17-7			
K	Grauguss	Grey cast iron	0.6025	GG25	100-400 (120-260 HB)	EN-GJ1-250
			0.6678	GGL-NiCr35 2	150-250 (160-230 HB)	EN-GJLA-XNiCr35-2
	Sphäroguss	Nodular cast iron	0.7060	GGG60	400-800	EN-GJS-600-3
			0.7070	GGG70L	(120-310 HB)	EN-GJS-700-2U
	Temperguss	Malleable cast iron	0.8155	GTS55	350-700 (150-280 HB)	EN-GJMB-550-4
N	Aluminium-Legierungen, kurzspanend	Aluminium alloys, short chipping	3.2581	G-AISi12	-400	G-IGK-AISi12
	Aluminium-Legierungen, langspanend	Aluminium alloys, long chipping	3.3535	AlMg3	-550	AlMg3
			3.4365	AlZnMgCu1,5		AlZnMgCu1,5
	Kupfer-Legierungen, kurzspanend	Copper alloys, short chipping	2.0402	MS58	-500	CuZn40Pb2
	Kupfer-Legierungen, langspanend	Copper alloys, long chipping	2.0320	MS63	300-500	CuZn37
			2.0975	CuAl10Ni		CuAl10Fe5Ni5-C
Thermoplaste	Thermoplastics		PVC	40-70	PVC	
Duroplaste	Duroplastics		Bakelit, Melamin	20-40	Bakelit, Melamin	

Schnittgeschwindigkeitskorrekturfaktoren siehe Seite 200
Cutting speed correction factor see page 200

	Schnitt- geschwindigkeit Cutting speed v_c (m/min)	Vorschub pro Zahn f_z bei Fräser-Ø Feed per tooth f_z for cutter diameter d_1 (mm)					
		5	8	12	20	32	> 50
	35	0,03	0,05	0,06	0,08	0,09	0,10
	35	0,03	0,05	0,06	0,08	0,09	0,10
	28	0,025	0,045	0,06	0,08	0,09	0,10
	28	0,025	0,05	0,06	0,08	0,09	0,10
	20	0,025	0,04	0,05	0,08	0,09	0,10
	35	0,03	0,05	0,06	0,08	0,09	0,10
	15	0,025	0,04	0,05	0,06	0,07	0,09
	20	0,02	0,04	0,05	0,08	0,09	0,10
	20	0,02	0,04	0,05	0,08	0,09	0,10
	20	0,02	0,04	0,05	0,08	0,09	0,10
	22	0,025	0,05	0,06	0,07	0,08	0,09
	22	0,025	0,05	0,06	0,07	0,08	0,09
	25	0,04	0,07	0,08	0,10	0,12	0,15
	22	0,03	0,05	0,06	0,08	0,09	0,10
	35	0,02	0,05	0,06	0,10	0,12	0,15
	42	0,02	0,05	0,06	0,10	0,12	0,15
	70	0,02	0,025	0,03	0,04	0,06	0,10
	250	0,03	0,03	0,03	0,03	0,03	0,03
	42	0,02	0,025	0,03	0,04	0,06	0,09
	35	0,03	0,05	0,06	0,08	0,09	0,10
	120	0,03	0,04	0,05	0,06	0,08	0,10
	70	0,03	0,04	0,05	0,06	0,08	0,10

Fräsen mit HSS-E-PM, HSS-E
Milling with HSS-E-PM, HSS-E

Die angegebenen Schnittwerte sind Startwerte und müssen auf die vorhandenen Bedingungen abgestimmt werden.
The cutting data indicated are starting values and must be adjusted to the prevailing conditions.

Schnittgeschwindigkeitskorrektur f_1 Cutting speed correction factor f_1		
	beschichtet coated	unbeschichtet uncoated
$f_1 =$	1,0	0,8

Schnittgeschwindigkeitskorrektur f_1 /Vorschubkorrektur f_2 für Kerbschlag-Biegeproben Fräser Cutting speed correction factor f_1 /Feed rate correction factor f_2 for notched-bar impact test milling cutters						
Modul m Module m (mm)	1	3	5	10	20	>30
Teilung T Pitch T (mm)	2,5	10	20	30	-	-
$f_1 =$	1	1	0,9	0,85	0,6	0,5
$f_2 =$	1	1	1	1,2	1,5	1,5

Vorschubkorrektur f_2 Cutting speed correction factor f_2
$f_2 = 0,5$

Drehzahl Speed	Vorschubgeschwindigkeit Feed rate	Zeitspanvolumen Chip removal rate	Spindelleistung Drive power
$n = \frac{v_c \cdot 1000}{\pi \cdot d_1} \cdot f_1$	$v_f = f_z \cdot z \cdot n \cdot f_2$	$Q = \frac{a_e \cdot a_p \cdot v_f}{1000}$	$P_e \approx \frac{Q}{LF}$

a_e = Schnittbreite Width of cut (mm)
 a_p = Schnitttiefe Depth of cut (mm)
 d_1 = Durchmesser Cutter diameter (mm)
 f_1 = Korrekturfaktor Correction factor (v_c)
 f_2 = Korrekturfaktor Correction factor (v_f)
 f_z = Vorschub pro Zahn Feed per tooth (mm)
 LF = Leistungsfaktor Efficiency factor (cm³/min/kW)

n = Drehzahl Speed (min⁻¹)
 P_e = Spindelleistung Drive power (kW)
 Q = Zeitspanvolumen Chip removal rate (cm³/min)
 v_c = Schnittgeschwindigkeit Cutting speed (m/min)
 v_f = Vorschubgeschwindigkeit Feed rate (mm/min)
 z = Anzahl der Schneiden No. of teeth



Fräsen mit HSS-E-PM, HSS-E
Milling with HSS-E-PM, HSS-E

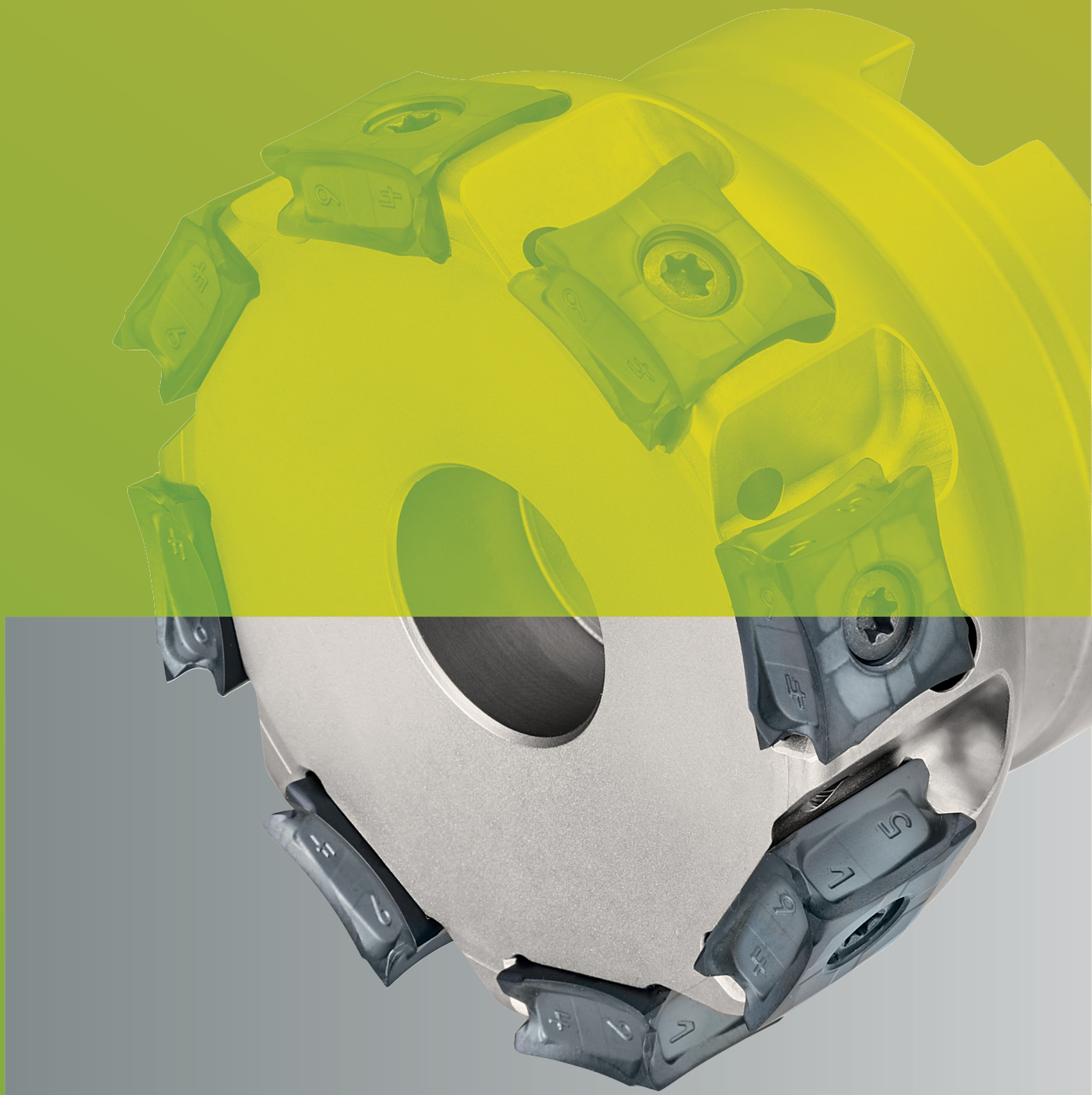

FRÄSEN

MIT WENDESCHNEIDPLATTEN
MILLING WITH INDEXABLE INSERTS

Fräsen mit Wendeschneidplatten Milling with indexable inserts

208 **Auswahlübersichten** Selection tables

Eckfräsen 90°

Shoulder milling 90°

Univex Premium

219	Aufschauber Screw-on type
220	Schaftfräser Shank type
222	Aufstecker Arbor type
223	Walzenstirnfräser Helical milling cutter
224	Wendeschneidplatten Inserts

MultiEdge T90 PRO8

233	Aufstecker Arbor type
233	Wendeschneidplatten Inserts

MultiEdge T90 PRO4

237	Aufstecker Arbor type
237	Wendeschneidplatten Inserts

Twincut 90°

240	Aufstecker Arbor type
241	Wendeschneidplatten Inserts

Fräser 90° für NE-Metalle und Kunststoffe Mills 90° for non-ferrous metals and plastics

406	Aufschauber Screw-on type
406	Schaftfräser Shank type
407	Aufstecker Arbor type
407	Wendeschneidplatten Inserts

Planfräsen

Face milling

MultiFace H45 PRO4

245	Aufstecker Arbor type
247	Wendeschneidplatten Inserts

MultiFace P45 PRO8

251	Aufstecker Arbor type
253	Wendeschneidplatten Inserts

MultiEdge Double8

256	Aufstecker Arbor type
257	Wendeschneidplatten Inserts

MultiEdge FCT45

260	Aufstecker Arbor type
261	Wendeschneidplatten Inserts

MultiEdge VA

266	Aufstecker Arbor type
266	Wendeschneidplatten Inserts

MultiEdge 45 Double4

270	Aufstecker Arbor type
270	Wendeschneidplatten Inserts

Hochvorschubfräsen

High feed milling

MultiEdge 2Feed mini

275	Aufschauber Screw-on type
275	Aufstecker Arbor type
276	Wendeschneidplatten Inserts

MultiEdge 3Feed

280	Aufschauber Screw-on type
280	Schaftfräser Shank type
281	Wendeschneidplatten Inserts

MultiEdge 4Feed

284	Aufschauber Screw-on type
285	Schaftfräser Shank type
286	Aufstecker Arbor type
287	Wendeschneidplatten Inserts

MultiEdge Double4Feed

288	Aufstecker Arbor type
288	Wendeschneidplatten Inserts

Schnittwertempfehlungen und technische Hinweise finden Sie direkt nach jedem Produkt.

Please find cutting data recommendations and technical hints right after each product.



Fräsen mit Wendeschneidplatten Milling with indexable inserts

Einstellbare Frässysteme

Adjustable milling systems

SpeedLift

292 Stech- und Planfräser
Plunge and face milling cutters

292 Wendeschneidplatten
Inserts

Feed-Jet

297 Planfräser
Face milling cutters

298 Wendeschneidplatten
Inserts

Feed-Jet PLUS

301 Planfräser
Face milling cutters

Kopierfräser

Copying cutters

ACU-Jet Premium

303 Kopier-Aufschraubfräser
Copying screw-on type cutters

304 Kopierschaftfräser
Copying end mills

305 Kopierfräser
Copying mills

ACU-Jet Double6 Premium

307 Kopier-Aufschraubfräser
Copying screw-on type cutters

307 Kopierfräser
Copying end mills

ACU-Jet Double6

308 Kopierfräser
Copying end mills

309 Wendeschneidplatten
Inserts

314 LMT Kieninger Nanomold Beschichtungskonzept
LMT Kieninger Nanomold coating concept

Schlichtfräser für den Gesenk- und Formenbau

Finishing end mills for mold and die

FinishLine Premium

316 Aufschraubfräser
Screw-on type

316 Planfräskopf
Face milling cutter

317 Schaftfräser
End mills

317 Wendeschneidplatten
Inserts

Kugel-Kopierfräsen

Ball nose copying cutters

CopyMax

321 Kugel-Kopierfräser
Ball nose copy cutters

323 Wendeschneidplatten
Inserts

GRT

330 Kugel-Kopierschruppfräser
Ball nose copy roughing cutters

323 Wendeschneidplatten
Inserts

Schnittwertempfehlungen und technische Hinweise finden Sie direkt nach jedem Produkt.
Please find cutting data recommendations and technical hints right after each product.

Kopierfräsen

Copying cutters

GWR/GWV

339 Kugel-Kopierfräser SuperFinish mit Hartmetallschaft
Ball nose copy cutters SuperFinish with carbide shank

340 Kugel-Kopierfräser GWR 5x mit Hartmetallschaft
Ball nose copy cutters GWR 5x with carbide shank

341 Kugel-Kopierfräser GWR mit Hartmetallschaft
Ball nose copy cutters GWR with carbide shank

342 Kugel-Kopierfräser GWR mit Stahlschaft
Ball nose copy cutters GWR with steel shank

343 Kugel-Kopierfräser GWR mit Morsekegel
Ball nose copy cutters GWR with morse taper

344 Kugel-Kopierfräser GWR mit konischem Hals
Ball nose copy cutters GWR with tapered neck

345 Kugel-Kopieraufschraubfräser GWR
Ball nose screw-on type end mills GWR

346 Wendeschneidplatten
Inserts

366 Kopierfräser GWV mit Hartmetallschaft
Copy cutters GWV with carbide shank

367 Kopierfräser GWV mit Stahlschaft
Copy cutters GWV with steel shank

368 Kopierfräser GWV mit Morsekegel
Copy cutters GWV with morse taper

369 Kopieraufschraubfräser GWV
Screw-on type copy cutters GWV

370 Wendeschneidplatten
Inserts

Profilfräser

Contour milling cutters

Kopier-Schruppfräser (EBT)

Roughing milling cutter (EBT)

402 Aufschrauber
Screw-on type

402 Schaftfräser
Shank type

403 Wendeschneidplatten
Inserts

Fasenfräser 30°,45° und 60° (EFZ)

Bevel milling cutter 30°,45° and 60° (EFZ)

411 Schaftfräser
Shank type

411 Wendeschneidplatten
Inserts

T-Nutenfräser (ESP90)

T-Slot cutters (ESP90)

413 Schaftfräser
Shank type

413 Wendeschneidplatten
Inserts

Scheibenfräser (SMN90)

Side-milling cutters (SNM90)

416 Aufstecker
Arbor type

417 Wendeschneidplatten
Inserts

400 Schneidgeometrien und Anwendungen für GWR/GWV Kopierfräser
Cutting geometries with applications for GWR/GWV copying cutters

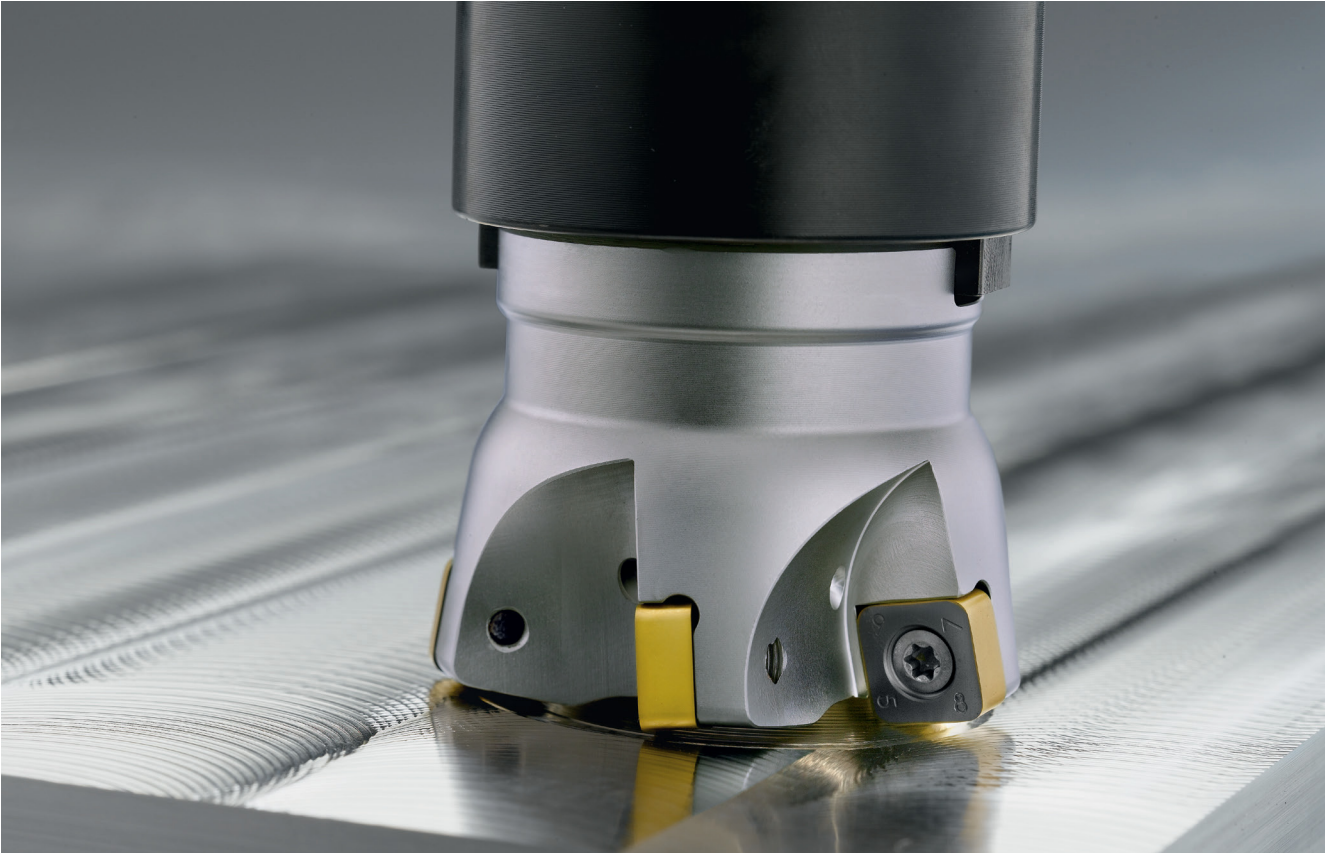





Tool Guide

Tool guide

1. Werkstoff Material

P	Stahl, Stahlguss, rostfreier Stahl, ferritisch und martensitisch Steel, cast steel, stainless steel, ferritic and martensitic
M	Rostfreier Stahl und Stahlguss, austenitisch und austenitisch/ferritisch Stainless steel and cast steel, austenitic and austenitic/ferritic
K	Grauguss, Sphäroguss, Temperguss Grey cast iron, cast iron with spheroidal graphite, malleable cast iron
N	Aluminium und andere Nichteisenmetalle, Kunststoffe, Graphit Aluminium and other non ferrous metals, plastic, graphite
S	Hochwarmfeste Stähle, Super- und Titanlegierungen High temperature alloys, super and titanium alloys
H	Gehärteter Stahl und Stahlguss Hardened steel and cast steel

2. Anwendung Application

Prozesse Processes	
 Schruppen Roughing	 Schruppen + Semischlichten Roughing + Semi finishing
 Semischlichten Semi finishing	 Schruppen + Schlichten Roughing + Finishing
 Schlichten Finishing	 Semischlichten + Schlichten Semi finishing + Finishing
	 Feinstschlichten Superfinishing
 Planfräsen Face milling	 Nutenfräsen Slot milling
 Kopierfräsen Copying	 Taschenfräsen Pocket milling
 Eckfräsen Corner milling	 Zirkularfräsen Circular milling
 Hochvorschubfräsen High feed milling	

3. Katalognummernverzeichnis Index of catalog numbers siehe Seite see page 500













4. Innenkühlung Internal cooling













 Zentrale Innenkühlung (IKZ) Central internal cooling (ICZ)	 Air-Jet Air-Jet
 Radiale Innenkühlung (IKR) Internal cooling radial (ICR)	

5. Gesamtpiktogrammübersicht Total pictogram overview ab Seite starting page 498

Schnellauswahl

Easy selection

 Eckfräsen Corner milling	 Planfräsen Face milling
<p>MultiEdge T90 PRO8 FMP90T X 233</p> <p>Ø 50–160 mm</p> <ul style="list-style-type: none"> ■ Tangentiales Eckfrässystem ■ Schnitttiefen bis 10 mm bei 8-fach nutzbarer Wendeschneidplatte ■ Direkt gesinterte Wendeschneidplatte ■ Tangential shoulder milling system ■ Depth of cut up to 10 mm with 8 times operable inserts ■ Directly sintered tangential insert <p>P K </p> 	<p>MultiFace P45 PRO8 FMP45 251</p> <p>Ø 50–160 mm</p> <ul style="list-style-type: none"> ■ Weichschneidendes System ■ Schnitttiefen bis 4 mm bei 8-fach nutzbarer Wendeplatte ■ Smooth cutting milling system ■ Depth of cut up to 4 mm with 8 times operable inserts <p>P M K S </p> 
<p>MultiEdge T90 PRO4 FMP90T L 237</p> <p>Ø 50–160 mm</p> <ul style="list-style-type: none"> ■ Tangentiales Eckfrässystem ■ Schnitttiefen bis 11,5 mm bei 4-fach nutzbarer Wendeschneidplatte ■ Direkt gesinterte Wendeschneidplatte ■ Tangential shoulder milling system ■ Depth of cut up to 11.5 mm with 4 times operable inserts ■ Directly sintered tangential insert <p>P K </p> 	<p>MultiFace H45 PRO4 FMH45 245</p> <p>Ø 50–160 mm</p> <ul style="list-style-type: none"> ■ Sehr weichschneidendes System ■ Schnitttiefen bis 6 mm bei 4-fach nutzbarer WSP ■ Very smooth cutting milling system ■ Depth of cut up to 6 mm with 4 times operable inserts <p>P M K N S </p> 
<p>Univex Premium 90° EMU90 / FMU90 219/222</p> <p>Ø 10–100 mm</p> <ul style="list-style-type: none"> ■ Exaktes 90° Eckfrässystem ■ Breites Programm an Schneidstoffen und Geometrien (WSP) ■ Träger mit Verschleisschutz ■ Exact 90° milling ■ Wide variety in cutting grades and geometries (inserts) ■ Body with wear protection <p>P M K N </p> 	<p>MultiEdge Double8 FMN45 256</p> <p>Ø 32–315 mm</p> <ul style="list-style-type: none"> ■ Doppelseitige WSP mit insgesamt 16 nutzbaren Schneiden ■ Unterschiedliche WSP-Größen ■ Wiper-Geometrie optional erhältlich ■ Double-sided insert with a total of 16 cutting edges ■ Different insert sizes ■ Wiper-geometry optional available <p>P K </p> 
<p>Univex Premium 90° ERU90 / FRU90 223</p> <p>Ø 20–80 mm</p> <ul style="list-style-type: none"> ■ Walzenstirnfräser zum 90° Eckfrässystem ■ Breites Programm an Schneidstoffen und Geometrien (WSP) ■ Träger mit Verschleisschutz ■ Helical end mills for 90° shoulder milling ■ Wide variety in cutting grades and geometries (inserts) ■ Body with wear protection <p>P M K N </p> 	<p>MultiEdge FCT45 260</p> <p>Ø 42–160 mm</p> <ul style="list-style-type: none"> ■ Frässystem zur Aufnahme unterschiedlicher WSP (z.B. Rund-WSP, 4-schneidige WSP oder 8-schneidige WSP) ■ Für Schrupp- und Schlichtoperationen ■ Milling system for different types of inserts (e.g. round inserts, inserts with 4 or 8 cutting edges) ■ For finishing and roughing applications <p>P M K N </p> 
<p>Twincut 90° FMT90 240</p> <p>Ø 40–160 mm</p> <ul style="list-style-type: none"> ■ Hohe Schnittgeschwindigkeiten ■ Trägerkörper mit Verschleißschutz ■ High feed rates ■ Main body with wear protection <p>P K N </p> 	<p>MultiEdge VA FMV45 266</p> <p>Ø 32–160 mm</p> <ul style="list-style-type: none"> ■ Stabiler Plattensitz inspedondere zur ISO-M-Bearbeitung ■ Kompatibel zur 4-schneidigen WSP des FCT45 ■ Für Schrupp- und Schlichtoperationen ■ Robust insert-seat especially for ISO-M-machining ■ Compatible with 4-sided inserts of FCT45 ■ For finishing and roughing applications <p>P M K N </p> 
<p>NE-Fräser 90° EMZ90 / FMZ90 406</p> <p>Ø 25–125 mm</p> <ul style="list-style-type: none"> ■ System für Nichteisenmetalle ■ Sehr scharfe Wendeplatten-Geometrie ■ Schnitttiefen bis zu 14 mm ■ System for non-ferrous metals ■ Very sharp insert geometry ■ Depth of cut up to 14 mm <p>N </p> 	<p>MultiEdge 45 Double4 FMP45 270</p> <p>Ø 40–125 mm</p> <ul style="list-style-type: none"> ■ Universelle WSP für breites Anwendungsfeld ■ Für Schrupp- und Schlichtoperationen ■ Universal insert for a wide field of applications ■ For finishing and roughing applications <p>P M K S </p> 

 Hochvorschubfräsen High feed milling	 Kopierfräsen Copy milling
MultiEdge 2Feed mini EHP / FHP 275 Ø 16–80 mm ■ Einheitliche WSP für den gesamten Durchmesserbereich ■ System für leistungsschwächere Bearbeitungszentren ■ Wirtschaftliche kleine direkt gepresste WSP ■ Unified insert for the entire diameter range ■ System for lower powered machining centers ■ Small and cost efficient press-to-size insert 	GWR Ball nose copying program EBG R 339 Ø 6–32 mm ■ Hochgenauer Sitz der Wendeschneidplatte ■ Höchste Qualität ■ Sehr genaue Rundlauf-toleranz ■ Extremely accurate insert seat ■ Maximum quality ■ Tight runout tolerance and balancing 
	GWV Toric copying program EBG V 366 Ø 6–32 mm ■ Hochgenauer Sitz der Wendeschneidplatte ■ Höchste Qualität ■ Sehr genaue Rundlauf-toleranz ■ Extremely accurate insert seat ■ Maximum quality ■ Tight runout tolerance and balancing 
MultiEdge 3Feed ECP 280 Ø 16–25 mm ■ Direkt gepresste Wendeschneidplatte ■ Vibrationsarmes Schnittverhalten ■ Press-to-size-inserts ■ Low on vibration cutting behaviour 	FinishLine Premium ECG / FCG 316 Ø 12–100 mm ■ Hohe Zähnezahl ■ Wendeplatte mit leistungsfähiger Beschichtung Nanomold Red ■ Perfektion in der Oberflächenqualität ■ High No. of teeth ■ Inserts with high performance coating Nanomold Red ■ Perfection in surface quality 
MultiEdge 4Feed ECP / FCP 284 Ø 20–100 mm ■ System für höchstes Zeitspanvolumen ■ Breites Programm an Schneidstoffen und Geometrien (WSP) ■ Wirtschaftliche Zerspanung ■ System for highest chip volumes ■ Wide variety in cutting grades and geometries (inserts) ■ Economic processing 	ACU-Jet Premium, ACU-Jet plus, ACU-Jet Double6 303 Ø 15–160 mm ■ Für Schrapp- und Schlicht-Operationen ■ Positiver Plattensitz (Plus) ■ CBN Wendeplatten ■ For roughing and finishing ■ Positive insert seat (plus) ■ CBN inserts 
MultiEdge Double4Feed HFN 288 Ø 50–160 mm ■ Hochvorschubplanfräser ■ Doppelseitige WSP mit insgesamt 8 nutzbaren Schneiden ■ Höchst wirtschaftlich Planfräsen ■ High feed face milling cutter ■ Double-sided insert with a total of 8 cutting edges ■ Highly economic face milling 	ACU-Jet Double6 Premium FCC 307 Ø 32–66 mm ■ Doppelseitige Wendeschneidplatte für bis zu 12 Einsätze ■ Für Schrapp- und Vorschlicht-Operationen ■ Wendeplatten Ø 12 und 16 mm ■ Double sided inserts up to 12 cutting edges ■ For roughing and semifinishing ■ Insert diameter 12 and 16 mm 
	CopyMax® Ball nose copying cutter 321 Ø 12–32 mm ■ Doppelseitige Wendeschneidplatte (CopyMax2) ■ Für Schrapp- und Vorschlicht-Operationen ■ Wirtschaftliche Lösung ■ Double-sided insert (CopyMax2) ■ For roughing and semi-finishing applications ■ Highly economic solution 

 Einstellbare Frässysteme Adjustable milling systems	 Profilfräsen Profile milling
<p>Feed-Jet 297</p> <p>Ø 36–125 mm</p> <ul style="list-style-type: none"> ■ Gute Oberflächenqualität ■ Maximale Anzahl an Schneidkanten ■ µ-genaue Einstellung der Oberflächenqualität ■ High surface quality ■ Maximum number of cutting edges ■ µm sensitive adjustment on plane runout <p>N </p> 	<p>T-Nutenfräser T-Slot cutters (ESP90) 413</p> <p>Ø 25–50 mm</p> <ul style="list-style-type: none"> ■ Nur Darstellung Standardprogramm ■ Erfahrung in Sonderwerkzeugen ■ Only display of standard range ■ Experience in various special tools <p>P K N </p> 
	<p>Scheibenfräser Side-milling cutters (SNM90) 416</p> <p>Ø 63–200 mm</p> <ul style="list-style-type: none"> ■ Nur Darstellung Standardprogramm ■ Erfahrung in Sonderausführungen ■ Only display of standard range ■ Experience in various special tools <p>P K </p> 
<p>SpeedLift Plunge- and face milling 292</p> <p>Ø 66–80 mm</p> <ul style="list-style-type: none"> ■ Für höchste Oberflächenanforderungen ■ Höchste Präzision in Plan- und Rundlauf ■ Einfache Handhabung ■ For highest surface requirements ■ Highest precision in axial and radial runout ■ Easy handling <p>P K </p> 	<p>Fasenfräser 30°, 45° und 60° Bevel milling cutter (EFZ) 411</p> <p>Ø 6–16 mm</p> <ul style="list-style-type: none"> ■ Schnitttiefen bis zu 13 mm ■ Depth of cut up to 13 mm <p>P K N </p> 

Auswahlübersicht Fräsen mit Wendeschneidplatten

Selection table milling with indexable inserts

Seite Page	Werkstoff Material						Prozess Process	Anwendung Application						Typ Type	Kat.-Nr. Cat.-No.		
	P	M	K	N	S	H											
219	■	■	■	■	□			■			■	■	■	■		Univex Premium Aufschraubfräser 90° Univex Premium screw on type end mills 90°	EMU90
220	■	■	■	■	□			■			■	■	■	■		Univex Premium Schafffräser 90° Univex Premium end mills 90°	EMU90
222	■	■	■	■	□			■			■	■	■	■		Univex Premium Eckfräsköpfe 90° Univex Premium face milling cutters 90°	FMU90
223	■	■	■	■	□	■					■	■	■	■		Univex Premium Walzenstirn-schafffräser 90° Univex Premium helical end mills 90°	ERU90
223	■	■	■	■	□	■					■	■	■	■		Univex Premium Walzenstirnfräser 90° Univex Premium helical mills 90°	FRU90
233	■		■					□			■					MultiEdge T90 PRO8 Aufsteckausführung MultiEdge T90 PRO8 Arbor type	FMP90T X
237	■		■					□			■					MultiEdge T90 PRO4 Aufsteckausführung MultiEdge T90 PRO4 Arbor type	FMP90T L
240	■	□	■	■	□						■		■	■		Twincut Eckfräs- köpfe 90° Twincut face milling cutters 90°	FMT90 11260
245	■	■	■	■	■			■					■	■		MultiFace H45 PRO4 Planfräsköpfe FMH45 face milling cutters	FMH45
251	■	■	■		■			■					■	■		MultiFace P45 PRO8 Planfräsköpfe FMH45 face milling cutters	FMP45
256	■	□	■		□			■					■	■		MultiEdge Double8 Planfräsköpfe MultiEdge Double8 face milling cutters	FMN45

■ = Hauptanwendung First choice
□ = Nebenanwendung Second choice

	a_p max.	∅ von – bis from – to	Zähnezahl z Number of teeth z	IK IC	Wendeschneidplattengröße Indexable insert size	Seite Page
	5,5	12–20	2–4		AD_X 06...	219
	8,5	20–32	3–6		AD_X 09...	
	12,0	32–40	4–6		AD_X 12...	
	5,5	10–25	1–6		AD_X 06...	220
	8,5	16–32	2–6		AD_X 09...	
	12,0	20–40	2–6		AD_X 12...	
	16,5	25–40	2–4		AD_X 17...	
	10,0	40–63	4–9		AD_X 12...	222
	15,0	40–100	4–9		AD_X 17...	
	25/33/41	20–40	2–3		AD_X 09...	223
	45/53				AD_X 12...	
	34/45	40–80	3–5		AD_X 12...	223
	48/63				AD_X 17...	
	10	50–160	5–20	 bis up to ∅ 125	XNMU 12...	233
	11,5	50–160	4–20	 bis up to ∅ 125	LNMU 13...	237
	7,0	40–63	5–7		SPKX 09...	240
	10,0	50–125	4–8		SPKX 12...	
	6,0	50–160	4–16	 bis up to ∅ 125	SEKT... 12...	245
					SEHT... 12...	
	4,0	50–160	4–15	 bis up to ∅ 125	OEKT... 06...	251
	3,0	32–63	3–9	 bis up to ∅ 100	ON... 05...	256
	4,0	50–160	4–19		ON... 06...	
	5,0	63–315	5–20		ON... 08...	



Auswahlübersicht
Selection table

Wendeschneidplattenfräser
Indexable insert cutters

Seite Page	Werkstoff Material						Prozess Process	Anwendung Application						Typ Type	Kat.-Nr. Cat.-No.		
	P	M	K	N	S	H											
260	■	■	■	■	□			■	■							MultiEdge Plan- und Kopier-Fräsköpfe MultiEdge face and copying cutters	FCT45
266	■	■	■	■	□			■								MultiEdge-VA Planfräsköpfe 45° MultiEdge-VA face milling cutters 45°	FMV45
270	■	■	■	■	■			■								MultiEdge 45 Double4 Planfräsköpfe 45° MultiEdge 45 Double4 face milling cutters 45°	FMP45
275	■	■	■		□	■		■								MultiEdge 2Feed mini Aufschraubfräser MultiEdge 2Feed mini screw-on type	EHP X09
275	■	■	■		□	■		■								MultiEdge 2Feed mini Aufsteckfräser MultiEdge 2Feed mini arbor type	FHP X09
280	■	■	■		□			■								MultiEdge 3Feed Aufschraubfräser MultiEdge 3Feed screw-on type end mills	ECP X07
280	■	■	■		□			■								MultiEdge 3Feed Schaftfräser MultiEdge 3Feed end mills shank type	
284	■	■	■		□			■								MultiEdge 4Feed Aufschraubfräser MultiEdge 4Feed screw-on type end mills	ECP
285	■	■	■		□			■								MultiEdge 4Feed Schaftfräser MultiEdge 4Feed end mills	ECP
286	■	■	■		□			■								MultiEdge 4Feed Aufsteckfräser MultiEdge 4Feed arbor type	FCP
288	■	□	■					■								MultiEdge Double4Feed Hochvorschub-Planfräser MultiEdge Double4Feed High feed milling cutters	HFN S12

■ = Hauptanwendung First choice
□ = Nebenanwendung Second choice

	a_p max.	Ø von – bis from – to	Zähnezahl z Number of teeth	IK IC	Wendeschneidplattengröße Indexable insert size	Seite Page
	3,0	42–80	4–7		OCKX 05...	260
	4,0				RCKX 12...	
	4,0				SAHT 10...	
	5,0	52–160	4–9		XOKX 16...	
	6,0				RCKX 16...	
	4,0				OCKX 06...	
	6,0				SAHT 13...	
	1,8				XCKX 16...	
	4,0	32–63	4–7		SAHT 10...	
	6,0	50–160	4–9		SAHT 13...	
	6,0	40–125	4–8		SOKX 15...	270
	1,0	16–42	2–6		XDMW 0903... XDMT 0903...	275
	1,0	35–80	5–9			275
	1,0	16–25	2–4		XP... W 0703... XPMT 0703...	280
		16–25	2–4			280
	1,0	20–35	2–5		XCNT 07... XCNW 07...	284
	1,2	32–42	3–5			
	1,0	20–32	2–4	bis up to Ø 100	XCNT 09... XCNW 09...	285
	1,2	32	3–4			
	1,2	42–52	3–6		XCNT 12... XCNW 12...	286
	1,5	42–100	3–10			
	1,5	50–160	4–15		SNKQ 120520 SN	288



Auswahlübersicht
Selection table

Wendeschneidplattenfräser
Indexable insert cutters

Seite Page	Werkstoff Material						Prozess Process	Anwendung Application						Typ Type	Kat.-Nr. Cat.-No.	
	P	M	K	N	S	H										
292	■	■	■	■	■	■		■							SpeedLift Stech- und Planfräser SpeedLift Plunge and face milling cutters	Speed Lift
297				■				■							Feed-Jet Planfräser Feed-Jet face milling cutters	Feed-Jet
301				■				■							Feed-Jet PLUS Planfräser Feed-Jet PLUS face milling cutters	Feed-Jet PLUS
303	■	■	■		□	■		■	■						ACU-Jet Premium Kopier-Aufschraub- fräser ACU-Jet Premium copying screw-on type cutters	ECZ ECC
304	■	■	■		□	■		■	■						ACU-Jet Premium Kopierschaftfräser ACU-Jet Premium copying end mills	ECZ
305	■	■	■		□	■		■	■						ACU-Jet Premium Kopierfräser ACU-Jet Premium copying end mills	FCC
307	■	■	■		■	■		■	■						ACU-Jet Double6 Premium Kopierfräser ACU-Jet Double6 Premium copying end mills	FCC
307	■	■	■		■	■		■	■						ACU-Jet Double6 Premium Kopierfräser-Aufschraubfräser ACU-Jet Double6 Premium copying screw-on type cutters	ECC
308	■	■	■		□	■		■	■						ACU-Jet Double6 Kopierfräser ACU-Jet Double6 copying end mills	FCC
316	■	□	■			■		■		■					FinishLine Premium Aufschraubfräser FinishLine Premium screw-on type	ECG
316	■	□	■			■		■		■					FinishLine Premium Planfräskopf FinishLine Premium face milling cutters	FCG
317	■	□	■			■		■		■					FinishLine Premium Schaftfräser FinishLine Premium end mills	ECG
321	■	■	■		■	■			■						CopyMax Kugel-Kopierfräser CopyMax ball nose copy cutter	EBC

■ = Hauptanwendung First choice
□ = Nebenanwendung Second choice

a_p max.	\varnothing von – bis from – to	Zähnezahl z Number of teeth	IK IC	Wendeschneidplattengröße Indexable insert size	Seite Page
	66–80	6–8		SPG 09T3 S TPE 1303 SR	292
	63–80	8–10		Schneideinsatz PCD insert	297
	63–125	8–16			
	63–160	6–14		Schneideinsatz PCD insert	301
	15–42	2–5		RD... 07... RD... 10... RD... 12...	303
	25–40	2–4		RD... 10...	304
				RD... 12...	
	52–160	5–10	 bis up to \varnothing 80	RD... 12...	305
				RD... 10...	
	32–66	4–7		RN... 12...	307
	32–66	4–7		RN... 12...	307
	52–100	5–8	 bis up to \varnothing 80	RN... 16...	308
	20–40	3–6		CPHX 080310	316
	42–100	6–13		CPHX 080310	316
1,0	12–32	2–5		CPHX 050210 CPHX 080310	317
	16–32 12–25	2		CMR...DR CMR...SR	321



Seite Page	Werkstoff Material						Prozess Process	Anwendung Application						Typ Type	Kat.-Nr. Cat.-No.
	P	M	K	N	S	H									
321	■	■	■	■	■				■					CopyMax Kugel-Kopierfräser CopyMax ball nose copy cutter	EBC
331	■		■	■	■				■					Kugel-Kopierschrupp- fräser GRT Ball nose copy roughing cutters GRT	GRT
339	■		■	■	■	■			■					Kugel-Kopierfräshalter Superfinish mit Hartmetallschaft Ball nose copy cutter Superfinish with carbide shank	WPR
340	■	□	■	■	■	■			■					Kugel-Kopierfräser GWR 5x mit Hartmetallschaft Ball nose copy cutters GWR 5x with carbide shank	GWR 5x
341	■	□	■	■	■	■			■					Kugel-Kopierfräser GWR mit Hartmetallschaft Ball nose copy cutters GWR with carbide shank	GWR
342	■	□	■	■	■	■			■					Kugel-Kopierfräser GWR mit Stahlschaft Ball nose copy cutters GWR with steel shank	GWR
343	■	□	■	■	■				■					Kugel-Kopierfräser GWR mit Morsekegel Ball nose copy cutters GWR with morse taper	GWR
344	■	□	■	■	■	■			■					Kugel-Kopierfräser GWR Ball nose copy cutters GWR	GWR
345	■	□	■	■	■	■			■					Kugel-Kopieraufschraubfräser GWR Ball nose screw-on type end mills GWR	GWR
366	■	□	■	■	■	■			■	■	■			Kopierfräser GWV mit Hartmetallschaft Copy cutters GWV with carbide shank	GWV
367	■	□	■	■	■	■			■	■	■			Kopierfräser GWV mit Stahlschaft Copy cutters GWV with steel shank	GWV
368	■	□	■	■	■				■	■	■			Kopierfräser GWV mit Morsekegel Copy cutters GWV with morse taper	GWV

■ = Hauptanwendung First choice
□ = Nebenanwendung Second choice





	a_p max.	Ø von – bis from – to	Zähnezahl z Number of teeth	IK IC	Wendeschneidplattengröße Indexable insert size	Seite Page
		16–32 12–25	2		CMR...DR CMR...SR	321
	12	25–32	2		WPR WRT WPT	331
		12/16/20	2		WPR SF	339
		6–8	2		WPR	340
		8–16				
		6–32	2	 ab starting Ø 10	WPR WPB FB	341
		12–32	2	 bis up to Ø 10	WPR WPB FB	342
						343
		6–32				344
		8–32				345
		8–32	2	 ≥ Ø10	WPB WPV	366
		12–32				367
						368

Fräsen mit Wendeschneidplatten
Milling with indexable inserts



Seite Page	Werkstoff Material						Prozess Process	Anwendung Application						Typ Type	Kat.-Nr. Cat.-No.		
	P	M	K	N	S	H											
369	■	□	■	■	■	■			■			■	■	■		Kopieraufschraubfräser GWV Screw-on type copy cutters GWV	GWV
402	■	□	■		□				■	■		■	■			Twincut-Kugel-Kopier-Schrupp-Aufschraubfräser Twincut ball nose copying screw-on type roughing cutter	EBT (11497)
406				■					■	■	■	■	■			Schaftfräser 90° für NE-Metalle und Kunststoffe End mill 90° for non-ferrous metals and plastics	EMZ90
407				■					■	■	■	■	■			Fräsköpfe 90° für NE Metalle und Kunststoffe Milling Cutters 90° for non-ferrous metals and plastics	FMZ90
411	■	□	■	■												Fasenfräser 30°, 45°, 60° Bevel milling cutter 30°, 45°, 60°	EFZ (1148)
412	■	□	■	■	□											Fasenfräser 45° Bevel milling cutter 45°	EFZ45 (11483)
413	■	□	■	■	□						■					T-Nutenfräser T-Slot cutters	ESP90 (11403)
416	■	□	■		□						■					Scheibenfräser, schmal Side milling cutter, narrow	SMN90
417	■	□	■		□						■					Scheibenfräser, schmal Side milling cutter, narrow	SMN90 (11035)

■ = Hauptanwendung First choice
□ = Nebenanwendung Second choice

	a_p max.	\emptyset von – bis from – to	Zähnezahl z Number of teeth	IK IC	Wendeschneidplattengröße Indexable insert size	Seite Page
		8–32	2	 $\geq \emptyset 10$	WPB WPV	369
	30	20	2		1179-25 CCMT 060204	402
	35	25			1179-35 CCMT 080308	
	40	32			1179-45 SNKX 0904AN	
	50	40			1179-55 SNKX 1205AN	
	50	50			1179-65 SNKX 1205AN	
	13	25	2		VPGT 160412-ALM	406
	14	32–42	2–3		VCGT 220530-ALM	
	14	42–125	3–6		VCGT 220530-ALM	407
	7	6	2		TCMT 16T304	411
	10	10,4	2		TCMT 16T304	
	7	1,3–6,3	1–2		TCMT 110202	
	13	16	2		TCMT 16T304	
	8	5,4–14,4	1–2		TCMT 110202	
	7	16	2		SDMT 090308	412
	10	20–32	2–3		SPMT 120408	
		25	4		CCMT 060204	413
		32	4		CCMT 080308	
		40	4		CCMT 09T308	
		50	4		CCMT 120408	
		80–200	8–16		LNHX 14...	416
		63–160	6–16		LNHX 14...	417

Flexibilität in der Trägerauswahl
(Aufschrauber, Schaft, Aufstecker)
Wide range of body types (Screw-on, Shank, Arbor type)

Breite Produktpalette für Stahl, Guss, rostfreie Stähle
und Nichteisenwerkstoffe
Diverse program of inserts for steel, cast iron, stainless steel and non-ferrous materials

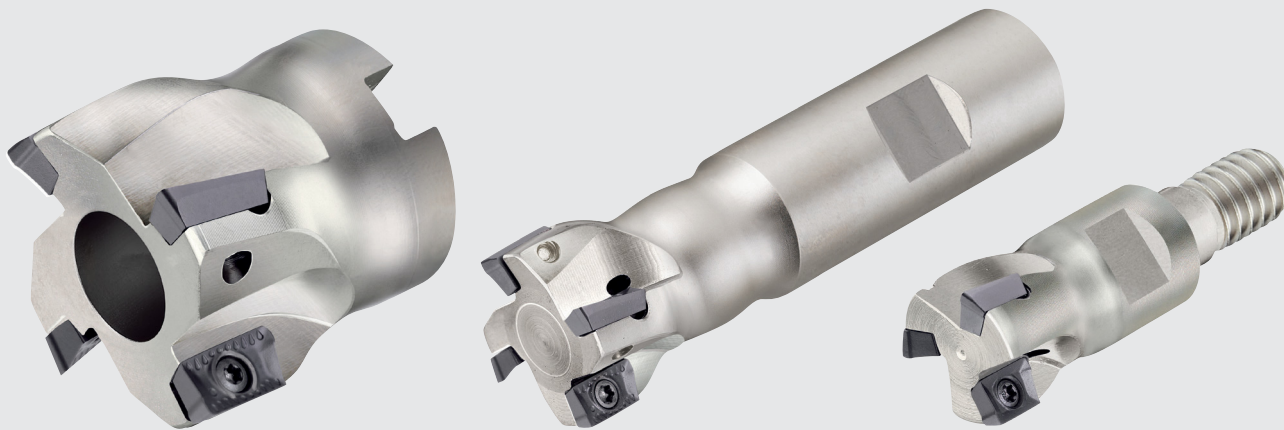

Hohe Vielfalt an Wendeschneidplatten
(Größen, Geometrien, Substrate)
High variety of indexable inserts
(size, geometry, grades)

Exakte 90° Eckfräsbearbeitung
Precise 90° shoulder milling

Überall dort, wo eine gerade Kante erzeugt werden muss, macht LMT Fette exaktes 90°-Eckfräsen möglich – mit Univex Premium. Und zwar in Stahl, Guss, rostfreiem Stahl und Nicht-Eisen-Werkstoffen.

Wherever straight edges are needed, LMT Fette makes precise 90° face milling possible – with Univex Premium, which works on steel, cast iron, stainless steel and non-iron materials.

Die Univex-Premium-Fräser verfügen über hervorragende Zerspanungseigenschaften: Sie arbeiten exakt, ruhig und bei geringer Leistungsaufnahme der Maschine. Für Sie bedeutet das hohe Produktivität und große Bearbeitungssicherheit.

Univex Premium milling cutters have outstanding machining properties: they work precisely, smoothly and allow the machine to operate with a low power consumption. This means high productivity and excellent processing safety.

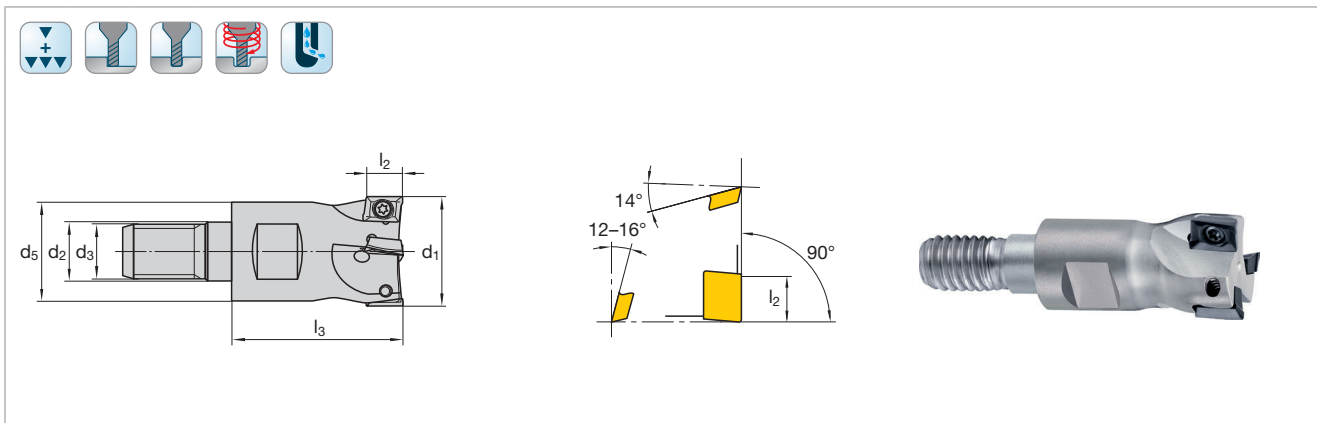

Katalog-Nr. Cat.-No.								EMU90 IK			
d ₁	l ₂	l ₃	d ₅	d ₃	d ₂	z	Ident No.	LMT-Code			
12	5,5	28	13	M8	8,5	2	7012580	EMU90 A06.012TR-I	ADHX 06... ADKX 06...	1045604	1048434 T6
16	5,5	28	13	M8	8,5	3	7012582	EMU90 A06.016TR-I			
20	5,5	30	18	M10	10,5	4	7012584	EMU90 A06.020TS-I	ADHX 09... ADKX 09...	2127640	1048326 T8
20	8,5	30	18	M10	10,5	3	7012585	EMU90 A09.020TS-I			
25	8,5	33	21	M12	12,5	4	7012586	EMU90 A09.025TF-I			
32	8,5	43	29	M16	17	6	7012587	EMU90 A09.032TH-I	ADHX 12... ADKX 12...	2237513	1048326 T8
32	12	43	29	M16	17	4	7012588	EMU90 A12.032TH-I			
40	12	43	29	M16	17	6	7012589	EMU90 A12.040TH-I			

Fräser auch verfügbar in Zoll-Abmessungen
 Cutters also available in inch dimensions

Schnittwertempfehlungen ab Seite 228
 Cutting data recommendations starting page 228



Maschinenbau, Füllkurve
 General machining, Filling cam

Werkzeug Tool:
 Univex Premium Schaftfräser 90°
 Univex Premium End Mill 90°
 EMU90, d₁ = 25, z = 3

Wendeplatte Insert:
 ADKX 120408 SR-TR, LCM45M

Werkstoff Material:
 1.4301 / X5CrNi18-10

Schnittwerte Cutting data:
 v_c = 240 m/min v_f = 1200 mm/min
 n = 3060 min⁻¹ a_e = 20 mm
 f_z = 0,13 mm a_p = 5 mm

Kühlung Coolant:
 trocken dry

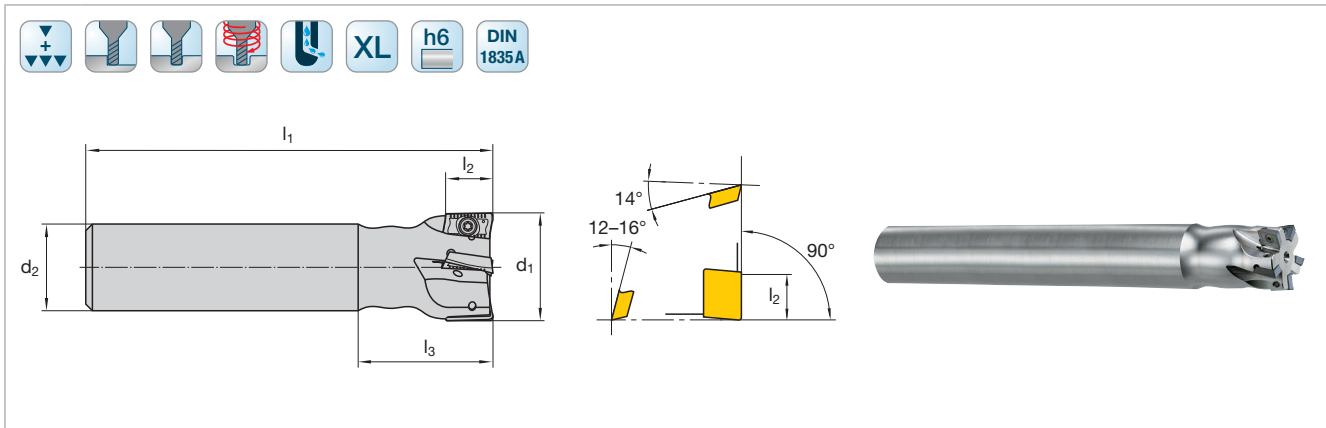



Katalog-Nr. Cat.-No.							EMU90 IK			
d ₁	l ₂	l ₁	l ₃	d ₂	z	Ident No.	LMT-Code			
25	16,5	200	40	25	2	1045043	EMU90 A17.025AN-IF	ADHX 17...	1045105	1048335
32	16,5	250	50	32	3	1045044	EMU90 A17.032AN-IF	ADKX 17...	1045114	T15
40	16,5	250	50	32	4	1045045	EMU90 A17.040AF-IF			

Fräser auch verfügbar in Zoll-Abmessungen
 Cutters also available in inch dimensions

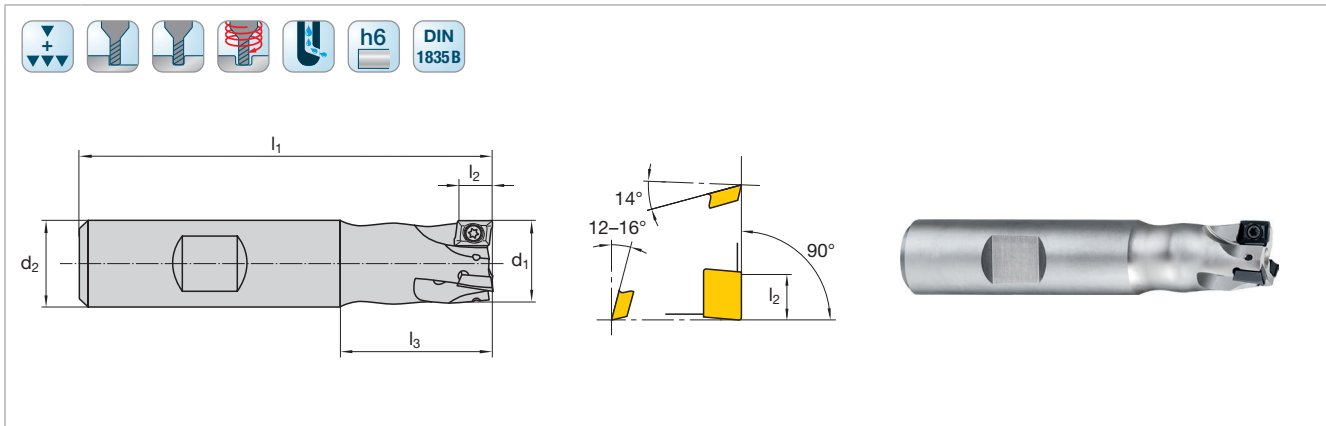

Schnittwertempfehlungen ab Seite 228
 Cutting data recommendations starting page 228

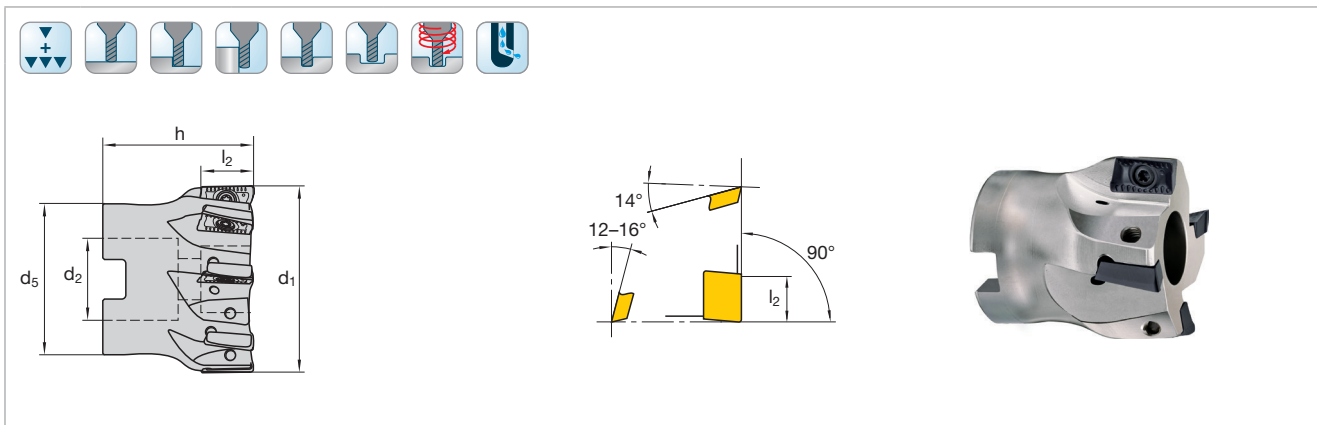

Katalog-Nr. Cat.-No.							EMU90 IK			
d ₁	l ₂	l ₁	l ₃	d ₂	z	Ident No.	LMT-Code			
10	5,5	60	20	10	1	1045062	EMU90 A06.010BN-I	ADHX 06... ADKX 06...	1045604	1048434 T6
12	5,5	70	25	12	2	1045063	EMU90 A06.012BN-I			
16	5,5	76	28	16	3	1045064	EMU90 A06.016BN-I			
20	5,5	86	36	20	4	1045066	EMU90 A06.020BN-I			
25	5,5	86	36	20	6	1045068	EMU90 A06.025BI-I			
16	8,5	76	28	16	2	1045071	EMU90 A09.016BN-I	ADHX 09... ADKX 09...	2127640	1048326 T8
20	8,5	86	36	20	3	1045072	EMU90 A09.020BN-I			
20	8,5	86	36	20	4	1045073	EMU90 A09.020BN-IF			
25	8,5	86	36	20	4	1045074	EMU90 A09.025BI-I			
25	8,5	86	36	20	5	1045075	EMU90 A09.025BI-IF			
32	8,5	96	40	25	6	1045076	EMU90 A09.032BG-I	ADHX 12... ADKX 12...	2237513	1048326 T8
20	12	86	36	20	2	1045090	EMU90 A12.020BN-I			
25	12	86	36	20	3	1045092	EMU90 A12.025BI-I			
32	12	96	40	25	4	1045093	EMU90 A12.032BG-I			
32	12	96	40	25	5	1045094	EMU90 A12.032BG-IF			
40	12	110	50	32	6	1045095	EMU90 A12.040BF-I	ADHX 17... ADKX 17...	1045105 1045114	1048335 T15
25	16,5	96	40	25	2	1045050	EMU90 A17.025BN-IF			
32	16,5	110	50	32	3	1045053	EMU90 A17.032BN-IF			
40	16,5	110	50	32	4	1045054	EMU90 A17.040BF-IF			

Schnittwertempfehlungen ab Seite 228
Cutting data recommendations starting page 228



Katalog-Nr. Cat.-No.							FMU90 IK			
d ₁	l ₂	h	d ₅	d ₂	z	Ident No.	LMT-Code			
40	8,5	40	32	16	4	7249850	FMU90 A09.040AN-IW	ADHX 09... ADKX 09...	2127640	1048326 T08
40	8,5	40	32	16	6	7249851	FMU90 A09.040AN-I			
50	8,5	40	40	22	5	7249852	FMU90 A09.050AN-IW			
50	8,5	40	40	22	7	7249853	FMU90 A09.050AN-I			
63	8,5	40	50	22	6	7249854	FMU90 A09.063AN-IW			
63	8,5	40	50	22	9	7249855	FMU90 A09.063AN-I			
40	12	40	32	16	4	1045100	FMU90 A12.040AN-I	ADHX 12... ADKX 12...	2237513	1048326 T08
40	12	40	32	16	6	1045101	FMU90 A12.040AN-IF			
50	12	40	40	22	5	1045102	FMU90 A12.050AN-I			
50	12	40	40	22	7	1045103	FMU90 A12.050AN-IF			
63	12	40	50	22	6	1045104	FMU90 A12.063AN-I			
63	12	40	50	22	9	1045106	FMU90 A12.063AN-IF			
40	16,5	40	32	16	4	1045035	FMU90 A17.040AN-I	ADHX 17... ADKX 17...	2237513	1048326 T08
50	16,5	40	40	22	4	7266631	FMU90 A17.050AN-I			
50	16,5	40	40	22	5	1045036	FMU90 A17.050AN-IF			
63	16,5	40	50	22	5	7266632	FMU90 A17.063AN-I			
63	16,5	40	50	22	6	1045037	FMU90 A17.063AN-IF			
80	16,5	50	60	27	6	7266633	FMU90 A17.080AN-I			
80	16,5	50	60	27	8	1045038	FMU90 A17.080AN-IF			
100	16,5	50	75	32	7	7266634	FMU90 A17.100AN-I			
100	16,5	50	75	32	9	1045039	FMU90 A17.100AN-IF			
125	16,5	63	90	40	9	7249856	FMU90 A17.125AN-I			
125	16,5	63	90	40	11	7249857	FMU90 A17.125AN-IF			

Fräser auch verfügbar in Zoll-Abmessungen
 Cutters also available in inch dimensions

Schnittwertempfehlungen ab Seite 228
 Cutting data recommendations starting page 228

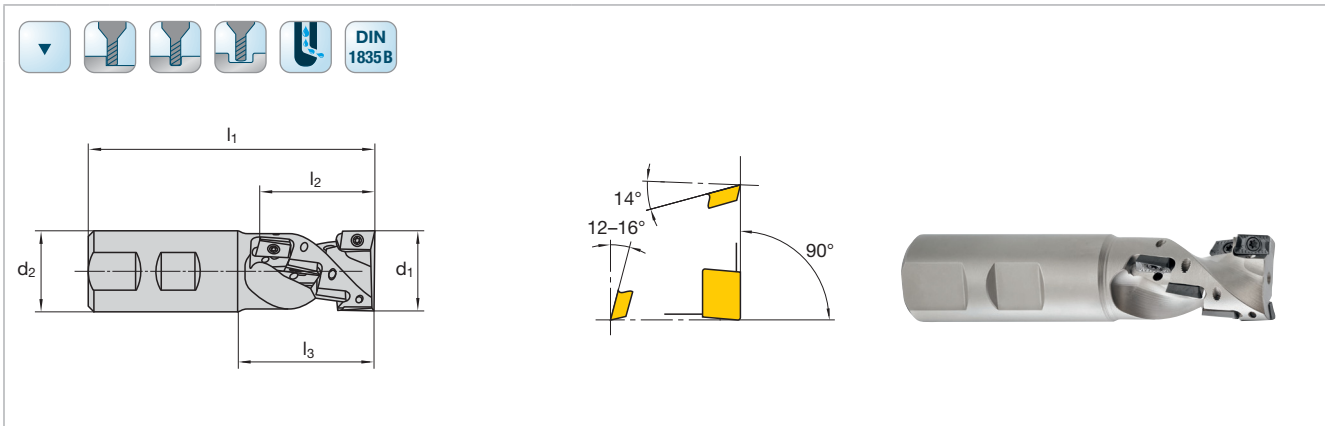

Katalog-Nr. Cat.-No.								ERU90			
d ₁	l ₂	l ₁	l ₃	d ₂	z	Anzahl WSP Number of inserts	Ident No.	LMT-Code			
20	25	86	36	20	2	6	7097646	ERU90 A09.020BN-I	ADHX 09... ADKX 09...	2127640	1048326 T8
25	33	100	44	25	2	8	7097647	ERU90 A09.025BN-I			
32	41	115	55	32	3	15	7097649	ERU90 A09.032BN-I	ADHX 12... ADKX 12...	2237513	
32	45	115	55	32	2	8	7097651	ERU90 A12.032BN-I			
40	55	140	70	40	3	15	7097653	ERU90 A12.040BN-I			

Schnittwertempfehlungen ab Seite 228
 Cutting data recommendations starting page 228

Univex Premium
Eckfräser – Walzenstirnausführung
Shoulder milling cutter – Helical type

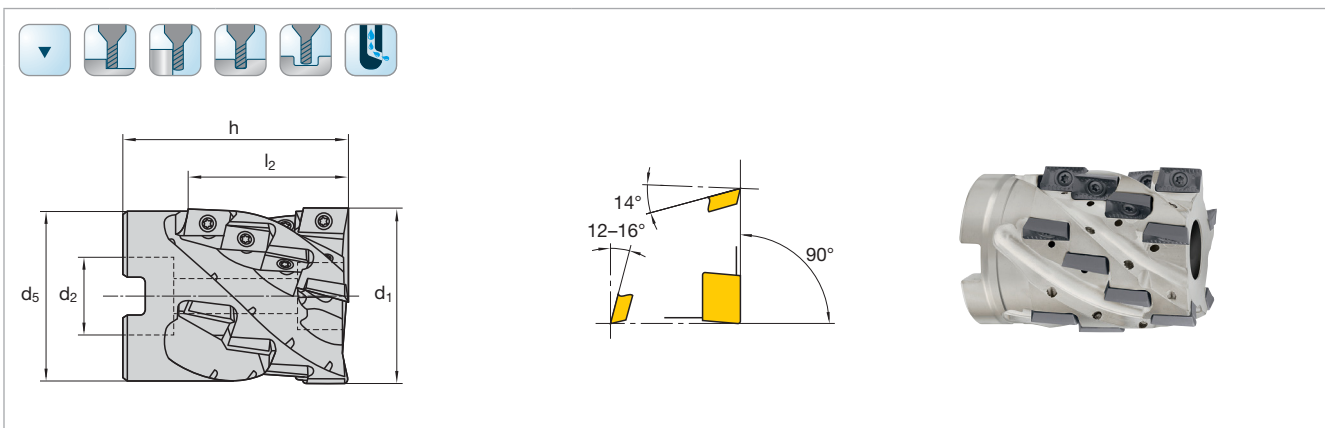

Katalog-Nr. Cat.-No.								FRU90			
d ₁	l ₂	h	d ₂	d ₅	z	Anzahl WSP Number of inserts	Ident No.	LMT-Code			
40	34	55	16	38	3	9	7097671	FRU90 A12.040AN-I	ADHX 12... ADKX 12...	2237513	1048326 T8
50	45	65	22	48	4	16	7097672	FRU90 A12.050AN-I			
63	45	70	27	58	5	20	7097673	FRU90 A12.063AN-I	ADHX 17... ADKX 17...	1045114	1048335 T15
63	48	70	27	58	4	12	7097674	FRU90 A17.063AN-I			
80	63	85	32	63	5	20	7097675	FRU90 A17.080AN-I			

Schnittwertempfehlungen ab Seite 228
 Cutting data recommendations starting page 228

							Schneidstoffsorten Cutting materials											Für Fräser For cutter											
							Ident No.																						
N = Anzahl der Schneidkanten N = Number of cutting edges	ISO-Code	l	d	s	d ₁	r	LCP40M	LCPM40M	LCPK30M	LCP25M	LCPK10M	LCM45M	LCM44M	LCKP30M	LCKP10M	LCK20M	LCK10M	LCN10M	LWN10M	LCHP15M	LCH50M	Cat-No.							
<p>N = 2</p>	ADHX 060202 FR-ALC	6,35	4,76	2,38	2	0,2									1069025					7020844			EMU90 IK						
<p>N = 2</p>	ADKX 060202 SR	6,35	4,76	2,38	2	0,2	1069020								1069021									EMU90 IK					
	ADKX 060204 SR	6,35	4,76	2,38	2	0,4	1069030								1069031														
¹⁾ nur mit ALC-Geometrie only with ALC-Geometry ■ = Hauptanwendung First choice □ = Nebenanwendung Alternative Sortenbeschreibung/-bezeichnung und ISO-Code ab Seite 424/477 Description/Designation of grades and ISO-Code starting page 424/477							■													□									P
							□																		M				
																■										K			
																						1)				N			
																										S			
																										H			

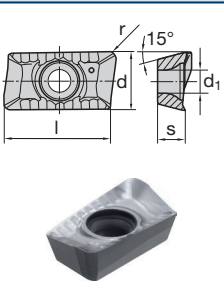
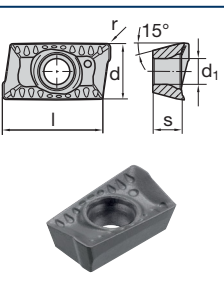
N = Anzahl der Schneidkanten N = Number of cutting edges		Schneidstoffsorten Cutting materials Ident No.											Für Fräser For cutter Cat-No.														
		ISO-Code	l	d	s	d ₁	r	LCP40M	LCPM40M	LCPK30M	LCP25M	LCPK10M		LCM45M	LCM44M	LCKP30M	LCKP10M	LCK20M	LCK10M	LCN10M	LWN10M	LCHP15M	LCH50M				
 N = 2	ADHX 090308 FR-ALC	9,52	5,56	3,18	2,8	0,8									1069059					7019458					EMU90 IK ERU90		
	ADHX 090312 FR-ALC	9,52	5,56	3,18	2,8	1,2									1069064					7019459							
	ADHX 090316 FR-ALC	9,52	5,56	3,18	2,8	1,6									1069069					7019510							
 N = 2	ADKX 090304 SR-TR	9,52	5,56	3,18	2,8	0,4		1069050							1069051		7048189								EMU90 IK ERU90		
	ADKX 090308 SR-TR	9,52	5,56	3,18	2,8	0,8		1069055				7054279	7054280		1069056		7048190										
	ADKX 090312 SR-TR	9,52	5,56	3,18	2,8	1,2		1069060				7054281	7054282		1069061		7048191										
	ADKX 090316 SR-TR	9,52	5,56	3,18	2,8	1,6		1069065				7054283	7054284		1069066		7048192										
													■													P	
													□													M	
																											K
																											N
																											S
																											H

■ = Hauptanwendung First choice
□ = Nebenanwendung Alternative
Sortenbeschreibung/-bezeichnung und ISO-Code ab Seite 424/477
Description/Designation of grades and ISO-Code starting page 424/477

Fräsen mit Wendeschneidplatten
Milling with indexable inserts

							Schneidstoffsorten Cutting materials										Für Fräser For cutter Cat-No.						
							Ident No.																
N = Anzahl der Schneidkanten N = Number of cutting edges	ISO-Code	l	d	s	d ₁	r	LCP40M	LCPM40M	LCPK30M	LCP25M	LCPK10M	LCM45M	LCM44M	LCKP30M	LCKP10M	LCK20M		LCK10M	LCN10M	LWN10M	LCHP15M	LCH50M	
 N = 2	ADHX 120408 FR-ALC	12,7	7,4	4,76	3,4	0,8									1069074					7019511			EMU90 IK ERU90 FMU90 IK FRU90
	ADHX 120412 FR-ALC	12,7	7,4	4,76	3,4	1,2									1069079					7019512			
	ADHX 120416 FR-ALC	12,7	7,4	4,76	3,4	1,6									1069084					7019513			
	ADHX 120420 FR-TR	12,7	7,4	4,76	3,4	2									1069089					7019514			
 N = 2	ADKX 120408 SR-TR	12,7	7,4	4,76	3,4	0,8	1069070					7054285	7054286		1069071		7048193					EMU90 IK ERU90 FMU90 IK FRU90	
	ADKX 120412 SR-TR	12,7	7,4	4,76	3,4	1,2	1069075					7054287	7054288		1069076		7048194						
	ADKX 120416 SR-TR	12,7	7,4	4,76	3,4	1,6	1069080					7054289	7054290		1069081		7048195						
	ADKX 120420 SR-TR	12,7	7,4	4,76	3,4	2	1069085					7054291	7054292		1069086		7048196						
	ADKX 120440 SR	12,7	7,4	4,76	3,4	4 ¹⁾	7017226																

■ = Hauptanwendung First choice
□ = Nebenanwendung Alternative

Sortenbeschreibung/-bezeichnung und ISO-Code ab Seite 424/477
Description/Designation of grades and ISO-Code starting page 424/477

¹⁾ ab Eckenradius r > 2 ist der Körper nachzuarbeiten.

from corner radius r > 2, subsequent machining must be carried out on the plate in the corner area.

²⁾ nur mit ALC-Geometrie
only with ALC-Geometry

■																							P
□												■	■										M
															■		■						K
																				■			N
																							S
																							H

		Schneidstoffsorten Cutting materials											Für Fräser For cutter Cat-No.										
		Ident No.																					
N = Anzahl der Schneidkanten N = Number of cutting edges	ISO-Code	l	d	s	d ₁	r	LCP40M	LCPM40M	LCPK30M	LCP25M	LCPK10M	LCM45M		LCM44M	LCKP30M	LCKP10M	LCK20M	LCK10M	LCN10M	LWN10M	LCHP15M	LCH50M	
 N = 2	ADHX 170508 FR-ALC	17,5	9,62	5,6	3,8	0,8										2414009				9206028			EMU90 IK FMU90 IK FRU90
	ADHX 170512 FR-ALC	17,5	9,62	5,6	3,8	1,2										7019835				7019836			
	ADHX 170516 FR-ALC	17,5	9,62	5,6	3,8	1,6										7019837				7019838			
	ADHX 170520 FR-ALC	17,5	9,62	5,6	3,8	2										7019839				7019840			
	ADHX 170530 FR-ALC	17,5	9,62	5,6	3,8	3 ¹⁾										7019841				7019842			
	ADHX 170540 FR-ALC	17,5	9,62	5,6	3,8	4 ¹⁾										7011958				7011957			
 N = 2	ADKX 170508 SR-TR	17,5	9,62	5,6	3,8	0,8			2412980														EMU90 IK FMU90 IK FRU90
	ADKX 170512 SR-TR	17,5	9,62	5,6	3,8	1,2			2412982			7054293	7054294	2413978	2414004								
	ADKX 170516 SR-TR	17,5	9,62	5,6	3,8	1,6			2412984			7054295	7054296	2413980	2414005					7048198			
	ADKX 170520 SR-TR	17,5	9,62	5,6	3,8	2			2412986			7054297	7054298	2413984	2414007					7048199			
	ADKX 170532 SR-TR	17,5	9,62	5,6	3,8	3,2 ¹⁾						7054299	7054300	2413228									

■ = Hauptanwendung First choice
□ = Nebenanwendung Alternative

Sortenbeschreibung/-bezeichnung und ISO-Code ab Seite 424/477
Description/Designation of grades and ISO-Code starting page 424/477

¹⁾ ab Eckenradius $r > 2$ ist der Körper nachzuarbeiten.
from corner radius $r > 2$, subsequent machining must be carried out on the plate in the corner area.

²⁾ nur mit ALC-Geometrie
only with ALC-Geometry

																							P
																							M
																							K
																							N
																							S
																							H

Fräsen mit Wendeschneidplatten
Milling with indexable inserts

Univex Premium
Schnittwertempfehlungen
Cutting data recommendations

	Werkstoff	Material	Werkstoff-Nr. Material No.	DIN Bezeichnung Alt DIN Description Old	R_m/UTS (N/mm²)	DIN Bezeichnung Neu DIN Description New
P	Unlegierter Baustahl + Automatenstahl	Plain carbon steel + free cutting steel	1.0570	St52-3	-700	S355J2G3
			1.1730	C45	-800	C45U
			1.0715	9SMn28	-700	11SMn30
			1.1191	Ck45	500-950	C45E
	1.7219	26CrMo4	26CrMo4-2			
	Vergütungsstahl, mittelfest	Heat-treatment steel, medium strength	1.7225	42CrMo4	500-950	42CrMo4
			1.8159	51CrV4		51CrV4
	Stahlguss	Cast steel	1.0416	GS40	-950	GS40
	Einsatzstahl	Case hardening steel	1.7131	16MnCr5	-950	16MnCr5
			1.4006	X10Cr13	500-950	X12Cr13
			1.4104	X12CrMoS17		X14CrMoS17
	Rost- und säurebeständiger Stahl, ferritisch, martensitisch	Stainless steel, ferritic, martensitic	1.4122	X35CrMo17		X39CrMo17-1
			1.7225	42CrMo4	950-1400	42CrMo4
	Vergütungsstahl, hochfest	Heat-treatment steel, high strength	1.6580	30CrNiMo8		
			1.8504	34CrAl6	950-1400	34CrAl6
	Nitrierstahl, vergütet	Nitriding steel, heat treated	1.2344	X40CrMoV5.1	-900	X40CrMoV5-1
			1.2379	X155CrVMo12 1	-950	X153CrMoV12-1
	Werkzeugstahl	Tool steel	1.2316	X38CrMo16	-1100	X38CrMo16
1.2080			X210Cr12	950-1400	X210Cr12	
1.2312			40CrMnNiMoS8.6	-1150	40CrMnNiMoS8-6	
1.2343			X38CrMoV5 1	950-1400	X37CrMoV5-1	
1.2358			60CrMoV18-5	850-1000	60CrMoV18-5	
1.2714			55NiCrMoV7	1100-1350	55NiCrMoV7	
1.2311			40CrMnMo7	-1100	40CrMnMo7	
1.2738			45CrMnNiMo8.6.4	950-1150	45CrMnNiMo8-6.4	
M	Rost- und säurebeständiger Stahl, austenitisch	Stainless steel, austenitic	1.4301	X2CrNiMo17-12-2	500-950	X5CrNiMo18-10
			1.4404	X6CrNiMoTi17-12-2		X2CrNiMo17-12-2
			1.4571	X10CrNiMoTi18		X10CrNiMoTi18
	Rost- und säurebeständiger Stahl, martensitisch aushärtbar	Stainless steel, martensitic steel	1.2709	X3NiCoMoTi18-9-5	800-1000	X3NiCoMoTi18-9-5
1.4542			X5CrNiCuNb16-4	X5CrNiCuNb16-4		
1.4568			X7CrNiAl17-7	X7CrNiAl17-7		
K	Grauguss	Grey cast iron	0.6025	GG25	100-400 (120-260 HB)	EN-GJ1-250
	Legierter Grauguss	Alloyed grey cast iron	0.6678	GGL-NiCr35 2	150-250 (160-230 HB)	EN-GJLA-XNiCr35-2
	Sphäroguss	Nodular cast iron	0.7060	GGG60	400-800	EN-GJS-600-3
			0.7070	GGG70L	(120-310 HB)	EN-GJS-700-2U
Temperguss	Malleable cast iron	0.8155	GTS55	350-700 (150-280 HB)	EN-GJMB-550-4	
N	Aluminium-Legierungen, kurzspanend	Aluminium alloys, short chipping	3.2581	G-AISi12	-400	G-IGK-AISi12
	Aluminium-Legierungen, langspanend	Aluminium alloys, long chipping	3.3535	AlMg3	-550	AlMg3
			3.4365	AlZnMgCu1,5		AlZnMgCu1,5
	Kupfer-Legierungen, kurzspanend	Copper alloys, short chipping	2.0402	MS58	-500	CuZn40Pb2
			2.0320	MS63		300-500
	Kupfer-Legierungen, langspanend	Copper alloys, long chipping	2.0975	CuAl10Ni		CuAl10Fe5Ni5-C
	Thermoplaste	Thermoplastics		PVC	40-70	PVC
Duroplaste	Duroplastics		Bakelit, Melamin	20-40	Bakelit, Melamin	
S	Titan-Legierungen, mittelfest	Titanium alloys, medium strength	3.7115	TiAl5Sn2,5	-950	TiAl5Sn2-5
			3.7164	TiAl6V4		Ti6AlV4
	Titan-Legierungen, hochfest	Titanium alloys, high strength	3.7174	TiAl6Sn2	900-1400	TiAl6V6Sn2
	Nickelbasis-Legierungen, mittelfest	Nickel based alloys, medium strength	2.4670	NiCr12Al6MoNb	-950	NiCr12Al6MoNb
2.4668			NiCr19Fe19NbMo	900-1400	Inconel 718 NiCr19Fe19Nb5Mo3	



Trockenbearbeitung, Pressluftkühlung ist vorteilhaft
 Dry machining, air-blast cooling is advantageous



Nassbearbeitung, auf ausreichende Emulsionszuführung achten
 Wet machining, sufficient emulsion volume required

Schnittgeschwindigkeit Cutting speed v_c (m/min)																	
Vorschub pro Zahn Feed per tooth f_z (mm/min)																	
LCP40M					LCK10M				LCM45M LCM44M				LCKP10M LCKP30M				
v_c (m/min)	f_z				v_c (m/min)	f_z			v_c (m/min)	f_z			v_c (m/min)	f_z			
	ADKX 0602	ADKX 0903	ADKX 1204	ADKX 1705		ADKX 0903	ADKX 1204	ADKX 1705		ADKX 0903	ADKX 1204	ADKX 1705		ADKX 0602	ADKX 0903	ADKX 1204	ADKX 1705
200–240	0,08	0,12	0,18	0,30								230–250	0,06	0,10	0,14	0,24	
200–240	0,08	0,12	0,18	0,30								230–250	0,06	0,10	0,14	0,24	
200–240	0,08	0,12	0,18	0,30								230–250	0,06	0,10	0,14	0,24	
200–240	0,08	0,12	0,18	0,30								230–250	0,06	0,10	0,14	0,24	
140–180	0,06	0,10	0,16	0,24								180–220	0,05	0,08	0,14	0,20	
140–180	0,06	0,10	0,16	0,24								180–220	0,05	0,08	0,14	0,20	
140–180	0,06	0,10	0,16	0,24								180–220	0,05	0,08	0,14	0,20	
120–140	0,05	0,08	0,14	0,20								140–180	0,04	0,06	0,11	0,16	
120–140	0,05	0,08	0,14	0,20								140–180	0,04	0,06	0,11	0,16	
120–140	0,05	0,08	0,14	0,20								140–180	0,04	0,06	0,11	0,16	
120–140	0,05	0,08	0,14	0,20								140–180	0,04	0,06	0,11	0,16	
120–140	0,05	0,08	0,14	0,20								140–180	0,04	0,06	0,11	0,16	
180–240	0,05	0,08	0,10	0,16					180–240 (60–80)	0,08	0,12	0,16					
					240–300	0,20	0,25	0,35				220–280	0,12	0,18	0,25	0,35	
					220–240	0,15	0,20	0,30				180–200	0,10	0,16	0,22	0,32	
					160–200	0,12	0,20	0,30				140–180	0,08	0,12	0,20	0,30	
												160–200	0,08	0,10	0,15	0,25	
												300–400	0,10	0,12	0,15	0,20	
												300–400	0,10	0,12	0,15	0,20	
												200–250	0,10	0,12	0,15	0,20	
												200–250	0,10	0,12	0,15	0,20	
												250–300	0,12	0,20	0,25	0,35	
												200–250	0,12	0,20	0,25	0,35	
								60–80	0,08	0,12	0,15	60–80	0,05	0,08	0,12	0,15	
								40–60	0,08	0,12	0,15	40–60	0,05	0,08	0,12	0,15	
								40–60	0,08	0,12	0,15	40–60	0,05	0,08	0,12	0,15	
								20–40	0,08	0,12	0,15	20–40	0,05	0,08	0,12	0,15	

Die angegebenen Schnittwerte sind Startwerte und müssen auf die vorhandenen Bedingungen abgestimmt werden.
The cutting data indicated are starting values and must be adjusted to the prevailing conditions.

Univex Premium
Schnittwertempfehlungen
Cutting data recommendations

	Werkstoff	Material	Werkstoff-Nr. Material No.	DIN Bezeichnung Alt DIN Description Old	R _m /UTS (N/mm ²)	DIN Bezeichnung Neu DIN Description New
N	Aluminium-Legierungen, kurzspanend	Aluminium alloys, short chipping	3.2581	G-AlSi12	-400	G-IGK-AlSi12
	Aluminium-Legierungen, langspanend	Aluminium alloys, long chipping	3.3535 3.4365	AlMg3 AlZnMgCu1,5	-550	AlMg3 AlZnMgCu1,5
	Kupfer-Legierungen, kurzspanend	Copper alloys, short chipping	2.0402	MS58	-500	CuZn40Pb2
	Kupfer-Legierungen, langspanend	Copper alloys, long chipping	2.0320 2.0975	MS63 CuAl10Ni	300-500	CuZn37 CuAl10Fe5Ni5-C
	Thermoplaste	Thermoplastics		PVC	40-70	PVC
	Duroplaste	Duroplastics		Bakelit, Melamin	20-40	Bakelit, Melamin

Die angegebenen Schnittwerte sind Startwerte und müssen auf die vorhandenen Bedingungen abgestimmt werden.
 The cutting data indicated are starting and must be adjusted to the prevailing conditions.

Univex Premium
Einsatzbereiche
Application areas

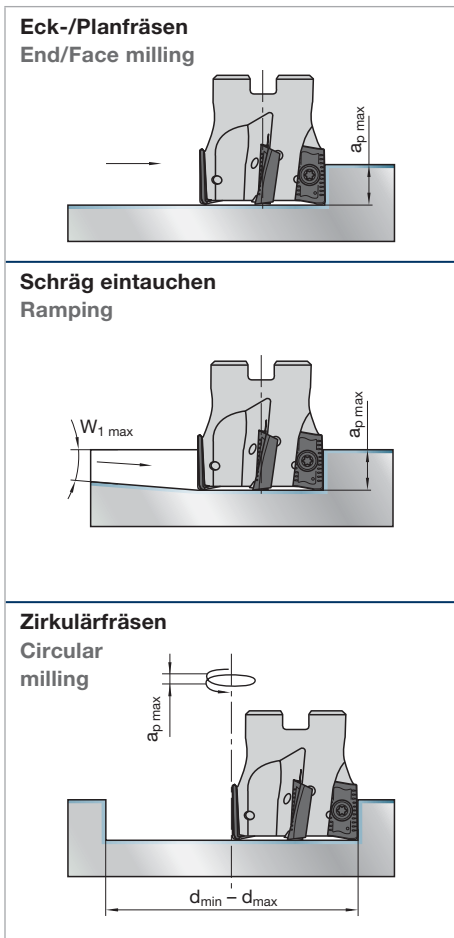

Werkzeug Tool	EMU90 A06	EMU90 A09	E(F)MU90 A12	E(F)MU90 A17
Wendeplatten Insert	AD_X 0602	AD_X 0903	AD_X 1204	AD_X 1705
a _p max (mm)	5,5	8,5	12	16,5
d ₁ (mm)	W ₁ max Eintauchwinkel Ramping angle(°)			
10	4,5			
12	3,5			
16	2,2	3		
20	1,8	2,3	3,5	
25	1,3	1,7	2,5	4
32		1,3	1,8	2,7
40			1,4	2
50			1,0	1,5
63			0,8	1,1
80				0,8
100				0,6
d ₁ (mm)	d _{min} - d _{max} (mm)			
10	17,5-20			
12	21,5-24			
16	29,5-32	28,5-32		
20	37,5-40	36,5-40	36-40	
25	47,5-50	46,5-50	46-50	45-50
32		60,5-64	60-64	59-64
40			76-80	75-80
50			96-100	95-100
63			121-125	120-125
80				155-160
100				195-200

a_p max max. Schnitttiefe max. depth of cut
 d₁ Werkzeugdurchmesser Tool diameter

Schnittgeschwindigkeit Cutting speed v_c (m/min)
 Vorschub pro Zahn Feed per tooth f_z (mm/min)

LWN10M

f_z

v_c (m/min)	ADHX 0602 FR-ALC	ADHX 0903 FR-ALC	ADHX 1204 FR-ALC	ADHX 1705 FR-ALC
350–500	0,10	0,12	0,15	0,20
800–1000	0,20	0,25	0,30	0,40
350–500	0,10	0,12	0,15	0,20
350–500	0,12	0,15	0,20	0,30
250–300	0,12	0,20	0,24	0,35
200–350	0,12	0,20	0,24	0,35



Aluminium Bauteil Führungssäule
 Aluminum component guide column

Werkzeug Tool:
 FMU90 IK, $d_1 = 50$, $z = 5$

Werkstoff Material:
 3.2315 / EN AW-6082 (Al Si1MgMn)

Wendeplatte Insert:
 ADHX 170508SR-ALC, LWN10M

Schnittwerte Cutting data:
 $v_c = 1000$ m/min
 $n = 6350$ min⁻¹
 $f_z = 0,15$ mm
 $v_f = 4750$ mm/min
 $a_e = 10$ mm
 $a_p = 5$ mm
 nass wet

Prozesssicherheit durch tangentielle Einbaulage der Wendeschneidplatten
Process safety by tangential mounting of the inserts

Schnitttiefe bis zu 10 mm
Depth of cut up to 10 mm

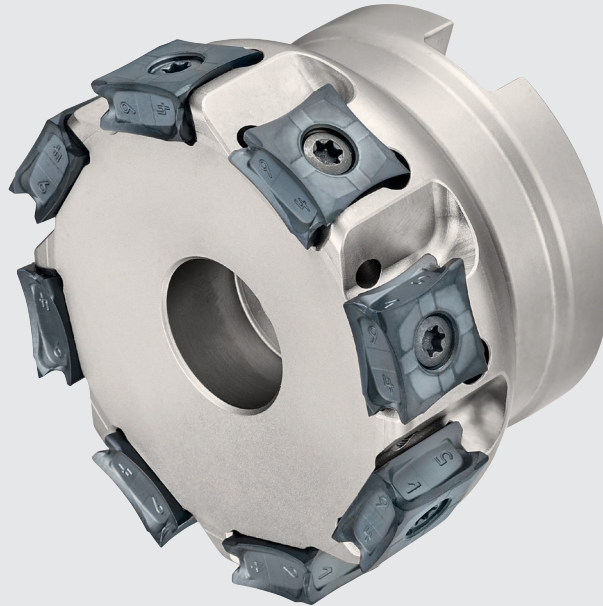

Kosteneinsparung durch Taktzeitverkürzung
Cost savings through cycle time reduction

Direkt gepresste WSP mit 8 effektiven Schneiden
Press-to-size-insert with 8 effective cutting edges

Das tangentielle Wendeplattenfrässystem MultiEdge T90 PRO8 ist für Schrapp- und Semischlichtoperationen in Stahl und Guss entwickelt.

The MultiEdge T90 PRO8 as modular milling systems with tangential inserts is designed for roughing and semi finishing operations in steel and cast iron.

Das Programm umfasst Trägerkörper im Durchmesserbereich von 50 bis 160 mm und Wendeschneidplatten mit Schnitttiefen bis zu 10 mm für die Bearbeitung von Stahl (ISO-P Werkstoffe) und Guss (ISO-K Werkstoffe).

The program covers cutter bodies in the diameter range from 50 to 160 mm and indexable inserts with cutting depths up to 10 mm for the machining of steel (ISO P materials) and cast iron (ISO K materials).

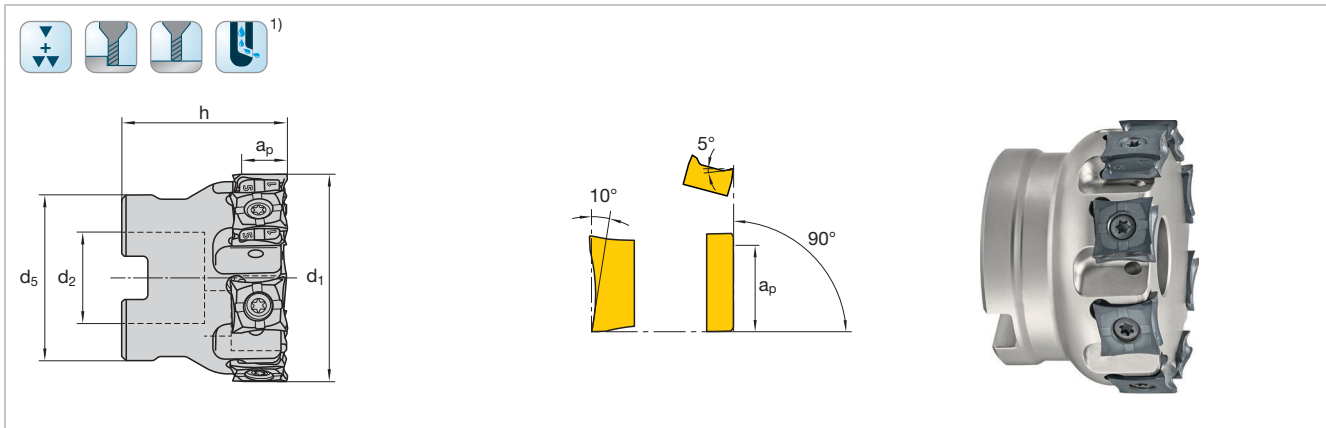

Katalog-Nr. Cat.-No.							FMP90T X				
d ₁	h	d ₂	d ₅	a _p	z	Ident No.	LMT-Code				
50	40	22	40	10	5	7164805	FMP90T X12.050AN-I	XNMU 120508ER	1045126	1048335 T15	
50	40	22	40	10	6	7193400	FMP90T X12.050AN-IF				
63	40	22	50	10	6	7164806	FMP90T X12.063AN-I				
63	40	22	50	10	8	7193401	FMP90T X12.063AN-IF				
80	50	27	60	10	8	7164807	FMP90T X12.080AN-I				
80	50	27	60	10	10	7193402	FMP90T X12.080AN-IF				
100	50	32	65	10	9	7164808	FMP90T X12.100AN-I				
100	50	32	65	10	12	7193403	FMP90T X12.100AN-IF				
125	63	40	90	10	11	7164809	FMP90T X12.125AN-I				
125	63	40	90	10	16	7193404	FMP90T X12.125AN-IF				
160	63	40	130	10	13	7164810	FMP90T X12.160AN				
160	63	40	130	10	20	7193405	FMP90T X12.160AN-F				

¹⁾ IK IC Ø 50-125

MultiEdge T90 PRO8
Wendeschneidplatten
 Indexable inserts

N = Anzahl der Schneidkanten N = Number of cutting edges	ISO-Code	Schneidstoffsorten Cutting materials											Für Fräser For cutter										
		Ident No.																					
		l	d	s	d ₁	r	LCP40M	LCPM40M	LCPK30M	LCP25M	LCPK10M	LCM45M		LCM44M	LCKP30M	LCKP10M	LCK20M	LCK10M	LCN10M	LWN10M	LCHP15M	LCH50M	
 N = 8	XNMU 120608 ER	12	12	6,35	4,4	0,8	7163384								7163385	7192762							FMP90T X
■ = Hauptanwendung First choice □ = Nebenanwendung Alternative												■ P ■ M ■ K ■ N ■ S ■ H											

Sortenbeschreibung/-bezeichnung und ISO-Code ab Seite 424/477
 Description/Designation of grades and ISO-Code starting page 424/477

MultiEdge T90 PRO8
Schnittwertempfehlungen
Cutting data recommendations

	Werkstoff	Material	Werkstoff-Nr. Material No.	DIN Bezeichnung Alt DIN Description Old	R _m /UTS (N/mm ²)	DIN Bezeichnung Neu DIN Description New
P	Unlegierter Baustahl	Plain carbon steel	1.0037, 1.0044 1.0052, 1.0070 1.0036, 1.0038	St37, St44 St52, St70 U- und and RST37-2	300–500 500–700 350–500	S235JR, S275JR St-52, E360 S235JRG1, S235JRG2
	Automatenstahl	Free cutting steel	1.0711, 1.0715 1.0727, 1.0728	9S20, 9SMn28 45S20, 60S20	360–550 600–800	9S20K, 11SmNPb30 46S20, 60S20
	Baustahl	Plain carbon steel	1.1191 1.7219	Ck45 26CrMo4	500–950	C45E 26CrMo4-2
	Vergütungsstahl, mittelfest	Heat-treatment steel, medium strength	1.7225 1.2241	42CrMo4 50CrV4	500–950	42CrMo4 51CrV4
	Stahlguss	Cast steel	1.0416	GS40	–950	GS40
	Einsatzstahl	Case hardening steel	1.7131	16MnCr5	–950	16MnCr5
	Vergütungsstahl, hochfest	Heat-treatment steel, high strength	1.7225 1.6580	42CrMo4 30CrNiMo8	950–1400	42CrMo4 30CrNiMo8
	Nitrierstahl, vergütet	Nitriding steel, heat treated	1.8504	34CrAl6	950–1400	34CrAl6
	Werkzeugstahl	Tool steel	1.2343 1.2379	X38CrMoV5.1 X155CrMoV12.1	950–1400	X37CrMoV5-1 X153CrMoV12-1
K	Gusseisen mit Lamellengraphit	Cast iron with flake graphite	EN-JL-1040 (0.6025)	EN-GJI-250 (GG25)	100–400 (120–260 HB)	EN-GJI-250
	Legiertes Gusseisen	Alloyed cast iron	(0.6678)	EN-GJLA-XNiCr35-2 (GGL-NiCr35-2)	150–250 (160–230 HB)	EN-GJLA-XNiCr35-2
	Gusseisen mit Kugelgraphit	Graphite cast iron	EN-JS-1060 (0.7060)	EN-GJS-600 (GGG60)	400–800 (120–310 HB)	EN-GJS-600-3
	Temperguss	Malleable cast iron	EN-JL-1160 (0.8155)	EN-GJMB-550-4 (GTS55)	350–700 (150–280 HB)	EN-GJMB-550-4

Die angegebenen Schnittwerte sind Startwerte und müssen auf die vorhandenen Bedingungen abgestimmt werden.
 The cutting data indicated are starting values and must be adjusted to the prevailing conditions.

Empfohlener Zahnvorschub bei $a_e = 0,66 \times d_1$
Recommended feed per tooth with $a_e = 0.66 \times d_1$

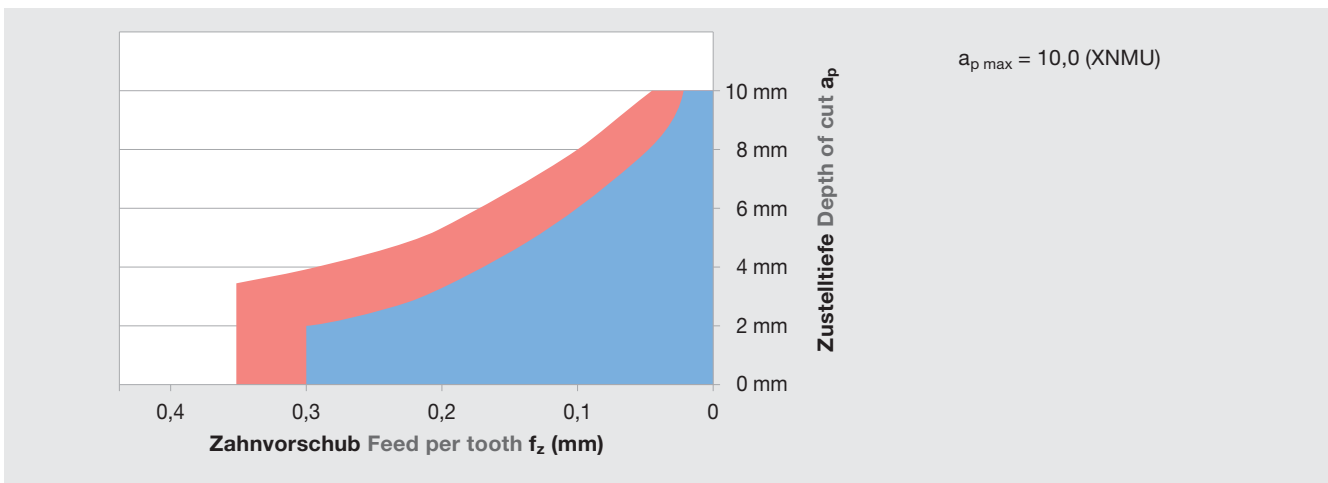

HM-Sorte Carbide grade	Empfohlene Schnittgeschwindigkeit v_c in m/min bei $a_e = 0,66 \times d_1$ Recommended cutting speed v_c in m/min with $a_e = 0.66 \times d_1$
	v_c
LCP40M	200–220
LCP40M	180–200
LCP40M	140–160
LCP40M	140–180
LCP40M	120–160
LCP40M	120–140
LCK20M	200–240
LCK20M	160–200
LCK20M	140–180
LCK20M	160–200

Fräsen mit Wendeschneidplatten
Milling with indexable inserts

XNMU

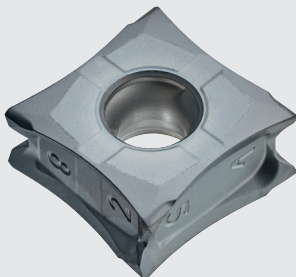

Spanformstufen Chip-breakers:

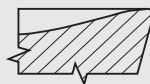

-ER

Merkmale:

- Weichschneidende Wendeschneidplatten-Geometrie zur Reduzierung der Zerspankräfte
- 8-schneidige tangentielle Wendeschneidplatte für hohe Wirtschaftlichkeit
- Zustelltiefen bis $a_{p \max} = 10 \text{ mm}$

Features:

- Soft-cutting indexable insert geometry to reduce cutting forces
- Tangential insert with 8 cutting edges for high efficiency
- Depth of cut up to $a_{p \max} = 10 \text{ mm}$

**Prozesssicherheit durch tangentielle
Einbaulage der Wendeschneidplatten**
Process safety by tangential
mounting of the inserts

Schnitttiefe bis zu 11,5 mm
Depth of cut up to 11,5 mm

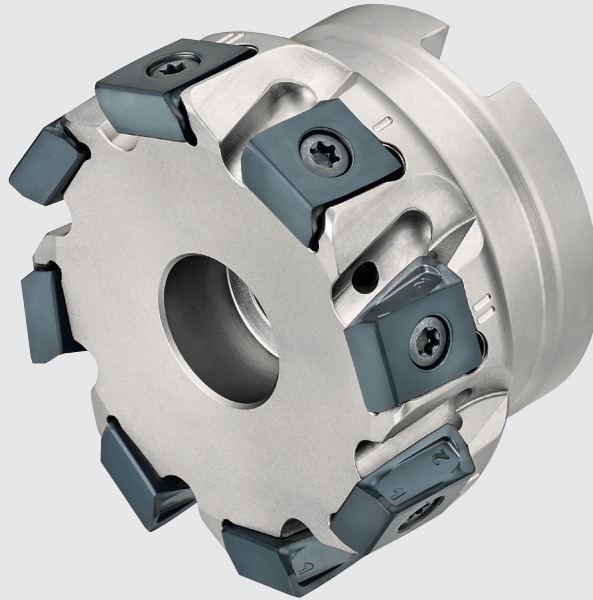

**Kosteneinsparung durch lange stabile Pro-
zesse**
Cost savings through long and stable pro-
cesses

**Direkt gepresste WSP mit 4 effektiven
Schneide** Press-to-size insert with 4 effective
cutting edges

Das tangentielle Wendeschneidplattenfrässystem MultiEdge T90 PRO4 ist für Schrupp- und Semischlichtoperationen in Stahl und Guss entwickelt.

The MultiEdge T90 PRO4 as modular milling systems with tangential inserts is designed for roughing and semi finishing operations in steel and cast iron.

Das Programm umfasst Trägerkörper im Durchmesserbereich von 50 bis 160 mm und Wendeschneidplatten mit Schnitttiefen bis zu 11,5 mm für die Bearbeitung von Stahl (ISO-P Werkstoffe) und Guss (ISO-K Werkstoffe).

The program covers cutter bodies in the diameter range from 50 to 160 mm and indexable inserts with cutting depths up to 11.5 mm for the machining of steel (ISO P materials) and cast iron (ISO K materials).

	Werkstoff	Material	Werkstoff-Nr. Material No.	DIN Bezeichnung Alt DIN Description Old	R _m /UTS (N/mm ²)	DIN Bezeichnung Neu DIN Description New
P	Unlegierter Baustahl	Plain carbon steel	1.0037, 1.0044 1.0052, 1.0070 1.0036, 1.0038	St37, St44 St52, St70 U- und and RST37-2	300–500 500–700 350–500	S235JR, S275JR St-52, E360 S235JRG1, S235JRG2
	Automatenstahl	Free cutting steel	1.0711, 1.0715 1.0727, 1.0728	9S20, 9SMn28 45S20, 60S20	360–550 600–800	9S20K, 11SmNPb30 46S20, 60S20
	Baustahl	Plain carbon steel	1.1191 1.7219	Ck45 26CrMo4	500–950	C45E 26CrMo4-2
	Vergütungsstahl, mittelfest	Heat-treatment steel, medium strength	1.7225 1.2241	42CrMo4 50CrV4	500–950	42CrMo4 51CrV4
	Stahlguss	Cast steel	1.0416	GS40	–950	GS40
	Einsatzstahl	Case hardening steel	1.7131	16MnCr5	–950	16MnCr5
	Vergütungsstahl, hochfest	Heat-treatment steel, high strength	1.7225 1.6580	42CrMo4 30CrNiMo8	950–1400	42CrMo4 30CrNiMo8
	Nitrierstahl, vergütet	Nitriding steel, heat treated	1.8504	34CrAl6	950–1400	34CrAl6
	Werkzeugstahl	Tool steel	1.2343 1.2379	X38CrMoV5.1 X153CrMoV12.1	950–1400	X37CrMoV5-1 X153CrMoV12-1
K	Gusseisen mit Lamellengraphit	Cast iron with flake graphite	EN-JL-1040 (0.6025)	EN-GJI-250 (GG25)	100–400 (120–260 HB)	EN-GJI-250
	Legiertes Gusseisen	Alloyed cast iron	(0.6678)	EN-GJLA-XNiCr35-2 (GGL-NiCr35-2)	150–250 (160–230 HB)	EN-GJLA-XNiCr35-2
	Gusseisen mit Kugelgraphit	Graphite cast iron	EN-JS-1060 (0.7060)	EN-GJS-600 (GGG60)	400–800 (120–310 HB)	EN-GJS-600-3
	Temperguss	Malleable cast iron	EN-JL-1160 (0.8155)	EN-GJMB-550-4 (GTS55)	350–700 (150–280 HB)	EN-GJMB-550-4

Die angegebenen Schnittwerte sind Startwerte und müssen auf die vorhandenen Bedingungen abgestimmt werden.
 The cutting data indicated are starting values and must be adjusted to the prevailing conditions.

Empfohlener Zahnvorschub bei $a_e = 0,66 \times d_1$
Recommended feed per tooth with $a_e = 0.66 \times d_1$

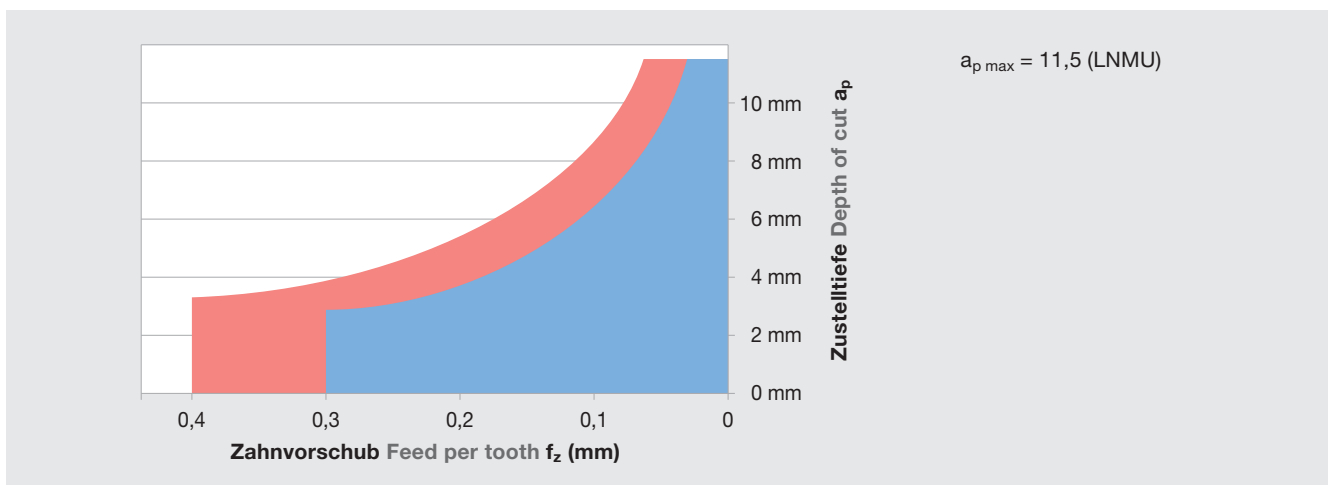

HM-Sorte Carbide grade	Empfohlene Schnittgeschwindigkeit v_c in m/min bei $a_e = 0,66 \times d_1$ Recommended cutting speed v_c in m/min with $a_e = 0.66 \times d_1$
	v_c
LCP40M	200–220
LCP40M	180–200
LCP40M	140–160
LCP40M	140–180
LCP40M	120–160
LCP40M	120–140
LCK20M	200–240
LCK20M	160–200
LCK20M	140–180
LCK20M	160–200

LNMU

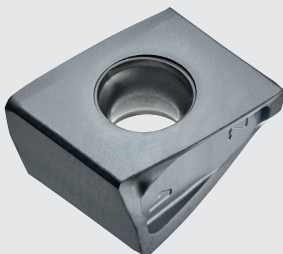

Spanformstufen Chip-breakers:

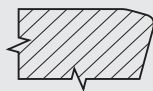

-SR

Merkmale:

- Stabile Wendeschneidplatten-Geometrie für ein breites Anwendungsspektrum
- 4-schneidige tangentielle Wendeschneidplatte für stabile Prozesse
- Zustelltiefen bis $a_{p \max} = 11,5 \text{ mm}$

Features:

- Robust insert geometry for a broad area of application
- Tangential insert with 4 cutting edges for high efficiency
- Depth of cut up to $a_{p \max} = 11.5 \text{ mm}$

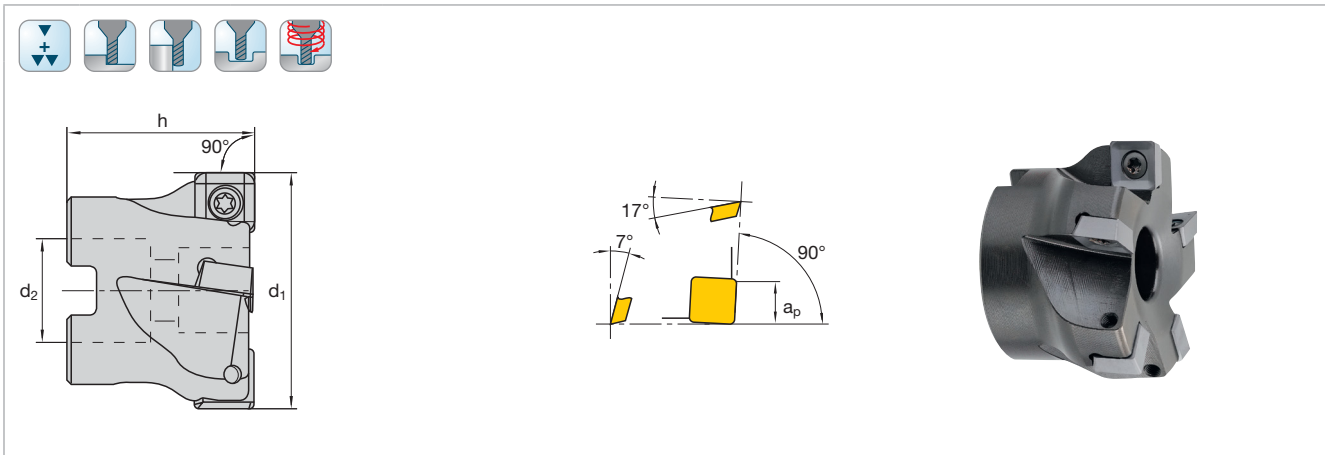

Katalog-Nr. Cat.-No.					FMT90				
d ₁	h	d ₂	z	a _p	Ident No.	LMT-Code			
11260-09									
40	40	16	5	7	1027394	FMT90 S09.040AN	SPKX 090406 1187-05	1045114	1048335 T15
50	40	22	6	7	1027395	FMT90 S09.050AN			
63	40	22	7	7	1027396	FMT90 S09.063AN			
11260-12									
50	40	22	4	10	1027380	FMT90 S12.050AN	SPKX 120508 1187-15	1045123	1048344 T20
63	40	22	5	10	1027382	FMT90 S12.063AN			
80	50	27	6	10	1027384	FMT90 S12.080AN			
100	50	32	7	10	1027386	FMT90 S12.100AN			
125	63	40	8	10	1027388	FMT90 S12.125AN			
160	63	40	9	10	1027390	FMT90 S12.160AN			

Schnittwertempfehlungen ab Seite 242
 Cutting data recommendations starting page 242

							Schneidstoffsorten Cutting materials Ident No.											Für Fräser For cutter Cat-No.							
N = Anzahl der Schneidkanten N = Number of cutting edges	ISO-Code	l	d	s	d ₁	b/r	LCP40M	LCPM40M	LCPK30M	LCP25M	LCPK10M	LCM45M	LCM44M	LCKP30M	LCKP10M	LCK20M	LCK10M	LCN10M	LWN10M	LCHP15M	LCH50M				
<p>N = 4</p>	SPKX 090406 1187-05	9,52	9,52	4,76	4,4	0,6	1055658								1069548									FMT90	
	SPKX 120508 1187-15	12,7	12,7	5,56	5,2	0,8	1052247								1052659				1052242						
							■								□									P	
							□																		M
																■									K
																				■					N
																									S
																									H

■ = Hauptanwendung First choice
□ = Nebenanwendung Alternative

Sortenbeschreibung/-bezeichnung und ISO-Code ab Seite 424/477
Description/Designation of grades and ISO-Code starting page 424/477

Twincut 90°
Schnittwertempfehlungen
Cutting data recommendations

	Werkstoff	Material	Werkstoff-Nr. Material No.	DIN Bezeichnung Alt DIN Description Old	R_m/UTS (N/mm²)	DIN Bezeichnung Neu DIN Description New
P	Unlegierter Baustahl + Automatenstahl	Plain carbon steel + free cutting steel	1.0570	St52-3	-700	S355J2G3
			1.1730	C45	-800	C45U
			1.0715	9SMn28	-700	11SMn30
			1.1191 1.7219	Ck45 26CrMo4	500-950	C45E 26CrMo4-2
	Vergütungsstahl, mittelfest	Heat-treatment steel, medium strength	1.7225	42CrMo4	500-950	42CrMo4
	Stahlguss	Cast steel	1.8159	51CrV4		51CrV4
	Einsatzstahl	Case hardening steel	1.0416	GS40	-950	GS40
			1.7131	16MnCr5	-950	16MnCr5
	Rost- und säurebe- ständiger Stahl, ferritisch, martensitisch	Stainless steel, ferritic, martensitic	1.4006	X10Cr13	500-950	X12Cr13
			1.4104	X12CrMoS17		X14CrMoS17
			1.4122	X35CrMo17		X39CrMo17-1
	Vergütungsstahl, hochfest	Heat-treatment steel, high strength	1.7225	42CrMo4	950-1400	42CrMo4
	Nitrierstahl, vergütet	Nitriding steel, heat treated	1.6580	30CrNiMo8		30CrNiMo8
			1.8504	34CrAl6	950-1400	34CrAl6
	Werkzeugstahl	Tool steel	1.2344	X40CrMoV5.1	-900	X40CrMoV5-1
			1.2343	X38CrMoV5 1	950-1400	X37CrMoV5-1
			1.2379	X155CrVMo12 1	-950	X153CrMoV12-1
			1.2358	60CrMoV18-5	850-1000	60CrMoV18-5
			1.2080	X210Cr12	950-1400	X210Cr12
1.2714			55NiCrMoV7	1100-1350	55NiCrMoV7	
1.2311			40CrMnMo7	-1100	40CrMnMo7	
1.2312			40CrMnNiMoS8.6	-1150	40CrMnNiMoS8-6	
1.2316			X38CrMo16	-1100	X38CrMo16	
1.2738			45CrMnNiMo8.6.4	950-1150	45CrMnNiMo8-6-4	
M	Rost- und säurebe- ständiger Stahl, austenitisch	Stainless steel, austenitic	1.4301	X2CrNiMo17-12-2	500-950	X5CrNiMo18-10
			1.4404	X6CrNiMoTi17-12-2		X2CrNiMo17-12-2
			1.4571	X10CrNiMoTi18		X10CrNiMoTi18
	Rost- und säurebe- ständiger Stahl, martensitisch aushärtbar	Stainless steel, martensitic steel	1.2709	X3NiCoMoTi18-9-5	800-1000	X3NiCoMoTi18-9-5
		1.4542	X5CrNiCuNb16-4		X5CrNiCuNb16-4	
		1.4568	X7CrNiAl17-7		X7CrNiAl17-7	
K	Grauguss	Grey cast iron	0.6025	GG25	100-400 (120-260 HB)	EN-GJ1-250
	Legierter Grauguss	Alloyed grey cast iron	0.6678	GGL-NiCr35 2	150-250 (160-230 HB)	EN-GJLA-XNiCr35-2
	Sphäroguss	Nodular cast iron	0.7060 0.7070	GGG60 GGG70L	400-800 (120-310 HB)	EN-GJS-600-3 EN-GJS-700-2U
	Temperguss	Malleable cast iron	0.8155	GTS55	350-700 (150-280 HB)	EN-GJMB-550-4
N	Aluminium-Legierungen, kurzspanend	Aluminium alloys, short chipping	3.2581	G-AlSi12	-400	G-IGK-AlSi12
	Aluminium-Legierungen, langspanend	Aluminium alloys, long chipping	3.3535	AlMg3	-550	AlMg3
			3.4365	AlZnMgCu1,5		AlZnMgCu1,5
	Kupfer-Legierungen, kurzspanend	Copper alloys, short chipping	2.0402	MS58	-500	CuZn40Pb2
	Kupfer-Legierungen, langspanend	Copper alloys, long chipping	2.0320	MS63	300-500	CuZn37
			2.0975	CuAl10Ni		CuAl10Fe5Ni5-C
	Thermoplaste	Thermoplastics		PVC	40-70	PVC
Duroplaste	Duroplastics		Bakelit, Melamin	20-40	Bakelit, Melamin	

Die angegebenen Schnittwerte sind Startwerte und müssen auf die vorhandenen Bedingungen abgestimmt werden.
The cutting data indicated are starting values and must be adjusted to the prevailing conditions.

	HM-Sorte Carbide grade	Vorschub pro Zahn Feed per tooth (mm)		
		Schlichten Finishing		Schruppen Roughing
		0,1	0,3	0,5
		Schnittgeschwindigkeit Cutting speed v_c (m/min)		
LCP40M	220	180	140	
LCP40M	220	180	140	
LCP40M	180	150	120	
LCP40M	160	130	100	
LCP40M	160	130	100	
LCP40M	160	130	100	
LCP40M	170	140	-	
LCP40M	150	120	-	
LCKP10M	150	120	-	
LCKP10M	150	120	-	
LCKP10M	150	120	-	
LCP40M	250-350	250-350	-	
LCP40M	250-350	250-350	-	
LCK10M	210	160	130	
LCK10M	160	130	100	
LCK10M	160	130	100	
LCK10M	210	160	120	
LWN10M	400	250	200	
LWN10M	500	350	250	
LWN10M	1200	900	700	
LWN10M	300	250	200	
LWN10M	500	350	250	
LWN10M	400	300	200	
LWN10M	250	250	250	

20° Spanwinkel für geringe Zerspanungskräfte
20° chipping angle for reduced machining forces

Schnitttiefe bis 6,5 mm
Depth of cut up to 6.5 mm

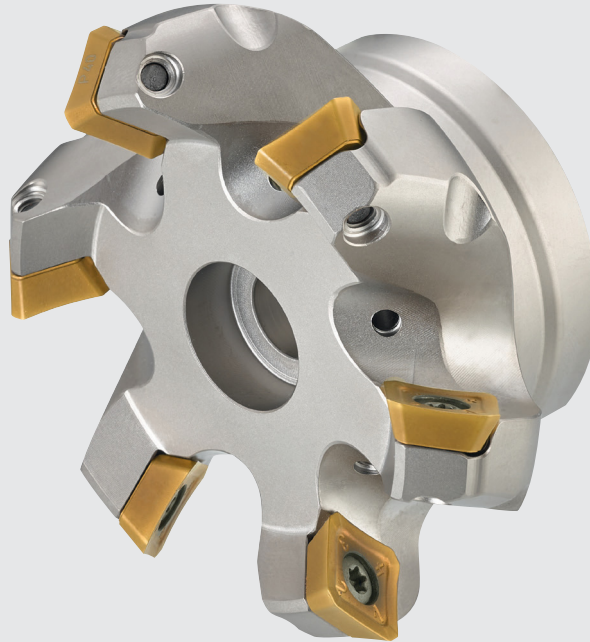

Schneidstoffe und Beschichtungen für lange Standzeiten und hohe Zerspanleistung
Cutting grades and coatings for a long tool life and high chipping volumes

Geometrien für die Bearbeitung von ISO-P, ISO-K, ISO-M, ISO-S und ISO-N
Geometries for the manufacturing of ISO-P, ISO-K, ISO-M, ISO-S and ISO-N

Mit den MultiFace H45 PRO4 erweitert LMT Fette sein Produktprogramm um ein sehr weichschneidendes Wendepaltenfräsystem zum Schruppen und Schlichten von unterschiedlichsten Werkstoffen.

Je nach Anforderung gibt es eine Ausführung für Schnitttiefen bis 6,5 mm mit vierschneidiger Wendeschneidplatte oder eine Ausführung für Schnitttiefen bis 4 mm mit achtschneidiger Wendeschneidplatte.

Für die Zerspanung der unterschiedlichen Werkstoffe gibt es eigens entwickelte Geometrien und Schneidstoffe.

Im Durchmesserbereich von 50 bis 160 mm bietet das Standardprogramm jeweils eine normale sowie feine Teilung.

With the MultiFace H45 PRO4, LMT Fette is expanding its product range with a very soft cutting edge milling system for roughing and finishing different materials.

Depending on the requirements, there is a tool for a depth of cut up to 6.5 mm with four cutting edges per insert or with a depth of cut up to 4 mm with eight cutting edge per insert.

For the machining of different materials there are specially developed geometries and cutting materials.

In the diameter range from 50 to 160 mm, the standard program offers a normal as well as fine pitched version.

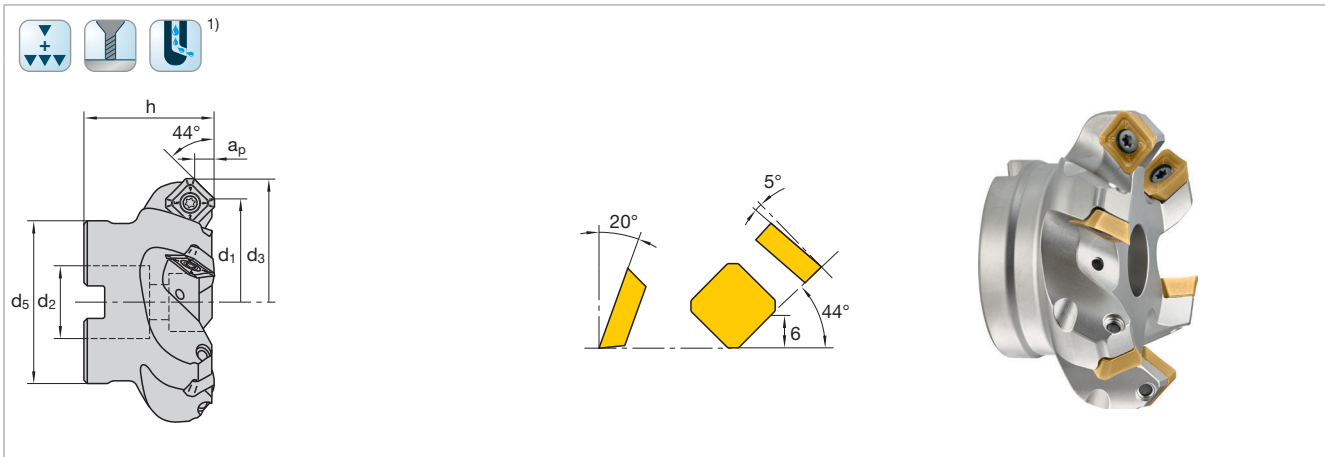

Katalog-Nr. Cat.-No.									FMH45		
d ₁	d ₃	h	d ₂	d ₅	z	a _p max	Ident No.	LMT-Code			
50	64	40	22	40	4	6	7220286	FMH45 S12.050AN-I	SE... 12	1045131	1048335 T15
50	64	40	22	40	5	6	7220292	FMH45 S12.050AN-IF			
63	77	40	22	50	5	6	7220287	FMH45 S12.063AN-I			
63	77	40	22	50	6	6	7220293	FMH45 S12.063AN-IF			
80	94	50	27	60	6	6	7220288	FMH45 S12.080AN-I			
80	94	50	27	60	8	6	7220294	FMH45 S12.080AN-IF			
100	114	50	32	75	7	6	7220289	FMH45 S12.100AN-I			
100	114	50	32	75	10	6	7220295	FMH45 S12.100AN-IF			
125	139	63	40	90	8	6	7220290	FMH45 S12.125AN-I			
125	139	63	40	90	12	6	7220296	FMH45 S12.125AN-IF			
160	174	63	40	130	10	6	7220291	FMH45 S12.160AN			
160	174	63	40	130	16	6	7220297	FMH45 S12.160AN-F			

¹⁾ IK Ø 50–125 mm
 IK Ø 50–125 mm

Schnittwertempfehlungen siehe Seite 248
 Cutting data recommendations see page 248



Planfräsoperation Kupferblock
Face milling operation on copper block

Werkzeug Tool:
 MultiFace H45 PRO4 (Ident No. 7220291),
 Ø 160, z = 10

Werkstoff Material:
 Kupfer Copper

Wendeplatte Insert:
 SEHT 1204AFEN- ALC in LWN10M (Ident No. 7251435)

Schnittwerte Cutting data:
 $v_c = 370 \text{ m/min}$ $a_p = 3 \text{ mm}$
 $n = 736 \text{ min}^{-1}$ $a_e = 102 \text{ mm}$
 $f_z = 0,3 \text{ mm}$

Ergebnis Result:
 Reduzierte Spindellast ermöglicht Nutzung eines größeren Werkzeugdurchmessers, doppeltes Zeitspanvolumen und 50 % höherer Standzeit.
 Reduced spindle load enables use of bigger diameter. Doubled chipping volume and 50 % longer tool life.



SEKT 1204AF-SN

Merkmale:

- Höchste Schneidkantenstabilität
- Für ungünstige Bearbeitungsbedingungen
- Negative Schutzfase mit Schneidkantenverrundung

Features:

- Very stable geometry
- For challenging applications
- Negative chamfer with edge preparation

Spanformstufen
Chip-breaker

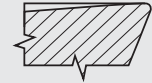

-SN



SEKT 1204AFEN-BM

Merkmale:

- Leichtschnidende Geometrie zur Reduzierung der Zerspankräfte
- Für gute Bearbeitungsbedingungen
- 8° Spanwinkel und Schneidkantenverrundung

Features:

- Soft-cutting geometry
- For uncomplicated applications
- Additional 8° chipping angle with edge preparation

Spanformstufen
Chip-breaker



-BM

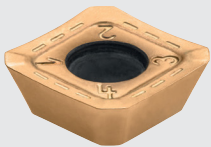

SEKT 1204AFSN-BMS

Merkmale:

- Universelle Geometrie für ein breites Anwendungsfeld
- Für mittlere Bearbeitungsbedingungen
- 15° Spanwinkel und negative Schutzfase mit Schneidkantenverrundung

Features:

- Universal geometry
- For cross-section applications
- Additional 15° chipping angle with edge preparation

Spanformstufen
Chip-breaker



-BMS



SEHT 1204AFFN-ALC

Merkmale:

- Scharfe Geometrie zur Aluminiumbearbeitung
- Geschliffene Wende
- 20° Spanwinkel
- Optional verrundete und beschichtete Ausführung (AFEN-ALC)

Features:

- Aluminium geometry
- Grinded insert with polished top
- Additional 20° chipping angle
- Optional with edge preparations and coating (AFEN-ALC)

Spanformstufen
Chip-breaker

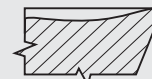

-ALC

N = Anzahl der Schneidkanten N = Number of cutting edges	ISO-Code	l	d	s	d ₁	r	Schneidstoffsorten Cutting materials												Für Fräser For cutter Cat-No.											
							Ident No.																							
							LCP40M	LCPM40M	LCPK30M	LCP25M	LCPK10M	LCM45M	LCMS35M	LCKP30M	LCKP10M	LCK20M	LCK10M	LCN10M		LWN10M	LCHP15M	LCH50M								
 N = 4	SEKT 1204 AFSN	12,7	12,7	4,76	4,4	-	7219983		7219984			7219985		7219986														FMH45		
 N = 4	SEKT 1204 AFEN-BM	12,7	12,7	4,76	4,4	-	7219987					7219988																	FMH45	
 N = 4	EKT 1204 AFSN-BMS	12,7	12,7	4,76	4,4	-	7219989					7219990																	FMH45	
 N = 4	SEHT 1204 AFFN-ALC	12,7	12,7	4,73	4,4	-																							FMH45	
	SEHT 1204 AFEN-ALC	12,7	12,7	4,73	4,4	-																								

■ = Hauptanwendung First choice
 □ = Nebenanwendung Alternative

Sortenbeschreibung/-bezeichnung und ISO-Code ab Seite 424/477
 Description/Designation of grades and ISO-Code starting page 424/477

■	■	□	□																														P	
□																																	M	
																																		K
																																		N
																																		S
																																		H

Fräsen mit Wendeschneidplatten
Milling with indexable inserts

MultiFace H45 PRO4
Schnittwertempfehlungen
Cutting data recommendations

	Werkstoff	Material	Werkstoff-Nr. Material No.	DIN Bezeichnung Alt DIN Description Old	Rm/UTS (N/mm²)	DIN Bezeichnung Neu DIN Description New
P	Unlegierter Baustahl + Automatenstahl	Plain carbon steel + free cutting steel	1.0570	St52-3	-700	S355J2G3
			1.1730	C45	-800	C45U
			1.0715	9SMn28	-700	11SMn30
			1.1191	Ck45	500-950	C45E
			1.7219	26CrMo4		26CrMo4-2
	Vergütungsstahl, mittelfest	Heat-treatment steel, medium strength	1.7225	42CrMo4	500-950	42CrMo4
			1.8159	51CrV4		51CrV4
	Stahlguss	Cast steel	1.0416	GS40	-950	GS40
	Einsatzstahl	Case hardening steel	1.7131	16MnCr5	-950	16MnCr5
	Rost- und säurebe- ständiger Stahl, ferritisch, martensitisch	Stainless steel, ferritic, martensitic	1.4006	X10Cr13	500-950	X12Cr13
			1.4104	X12CrMoS17		X14CrMoS17
			1.4122	X35CrMo17		X39CrMo17-1
	Vergütungsstahl, hochfest	Heat-treatment steel, high strength	1.7225	42CrMo4	950-1400	42CrMo4
			1.6580	30CrNiMo8		30CrNiMo8
	Nitrierstahl, vergütet	Nitriding steel, heat treated	1.8504	34CrAl6	950-1400	34CrAl6
			1.2344	X40CrMoV5.1	-900	X40CrMoV5-1
	Werkzeugstahl	Tool steel	1.2311	40CrMnMo7	-1100	40CrMnMo7
1.2312			40CrMnNiMoS8.6	-1150	40CrMnNiMoS8-6	
1.2316			X38CrMo16	-1100	X38CrMo16	
1.2738			45CrMnNiMo8.6.4	950-1150	45CrMnNiMo8-6-4	
1.2343			X38CrMoV5 1	950-1400	X37CrMoV5-1	
1.2379			X155CrVMo12 1	-950	X153CrMoV12-1	
1.2358			60CrMoV18-5	850-1000	60CrMoV18-5	
1.2080			X210Cr12	950-1400	X210Cr12	
1.2714			55NiCrMoV7	1100-1350	55NiCrMoV7	
M	Rost- und säurebe- ständiger Stahl, austenitisch	Stainless steel, austenitic	1.4301	X2CrNiMo17-12-2	500-950	X5CrNiMo18-10
			1.4404	X6CrNiMoTi17-12-2		X2CrNiMo17-12-2
			1.4571	X10CrNiMoTi18		X10CrNiMoTi18
	Rost- und säurebe- ständiger Stahl, martensitisch aushärtbar	Stainless steel, martensitic steel	1.2709	X3NiCoMoTi18-9-5	800-1000	X3NiCoMoTi18-9-5
			1.4542	X5CrNiCuNb16-4		X5CrNiCuNb16-4
1.4568	X7CrNiAl17-7		X7CrNiAl17-7			
K	Grauguss	Grey cast iron	0.6025	GG25	100-400 120-260 HB)	EN-GJI-250
	Legierter Grauguss	Alloyed grey cast iron	0.6678	GGL-NiCr35 2	150-250 160-230 HB)	EN-GJLA-XNiCr35-2
	Sphäroguss	Nodular cast iron	0.7060	GGG60	400-800	EN-GJS-600-3
			0.7070	GGG70L	120-310 HB)	EN-GJS-700-2U
	Temperguss	Malleable cast iron	0.8155	GTS55	350-700 150-280 HB)	EN-GJMB-550-4
N	Aluminium-Legierungen, kurzspanend	Aluminium alloys, short chipping	3.2581	G-AlSi12	-400	G-IGK-AlSi12
	Aluminium-Legierungen, langspanend	Aluminium alloys, long chipping	3.3535	AlMg3	-550	AlMg3
			3.4365	AlZnMgCu1,5		AlZnMgCu1,5
	Kupfer-Legierungen, kurzspanend	Copper alloys, short chipping	2.0402	MS58	-500	CuZn40Pb2
	Kupfer-Legierungen, langspanend	Copper alloys, long chipping	2.0320	MS63	300-500	CuZn37
			2.0975	CuAl10Ni		CuAl10Fe5Ni5-C
	Thermoplaste	Thermoplastics		PVC	40-70	PVC
Duroplaste	Duroplastics		Bakelit, Melamin	20-40	Bakelit, Melamin	
S	Titan-Legierungen, mittelfest	Titanium alloys, medium strength	3.7115	TiAl5Sn2,5	-950	TiAl5Sn2-5
			3.7164	TiAl6V4		Ti6AlV4
	Titan-Legierungen, hochfest	Titanium alloys, high strength	3.7174	TiAl6Sn2	900-1400	TiAl6V6Sn2
	Nickelbasis-Legierungen, mittelfest	Nickel based alloys, medium strength	2.4670	NiCr12Al6MoNb	-950	NiCr12Al6MoNb
Nickelbasis-Legierungen, hochwarmfest	Heat resistant nickel based alloys, high strength	2.4668	NiCr19Fe19NbMo	900-1400	Inconel 718 NiCr19Fe19Nb5Mo3	

Die angegebenen Schnittwerte sind Startwerte und müssen auf die vorhandenen Bedingungen abgestimmt werden.
The cutting data indicated are starting values and must be adjusted to the prevailing conditions.

HM-Sorte Carbide grade		Vorschub pro Zahn Feed per tooth f_z (mm/min)					
		Schruppen Roughing 			Schlichten Finishing 		
		v_c (m/min)	f_z (mm/z)	a_p SE max 6 OE max 4	v_c (m/min)	f_z (mm/z.)	a_p
LCP40M LCPK30M	150-250 180-280	0,20-0,40 0,15-0,30	3,0-6,0	180-300 200-320	0,08-0,20 0,08-0,15	0,2-2,0	
LCP40M LCPK30M	150-250 180-280	0,20-0,40 0,15-0,30	3,0-6,0	100-250 130-280	0,08-0,15 0,08-0,10	0,2-2,0	
LCP40M	150-250	0,20-0,40	3,0-6,0	180-300	0,08-0,20	0,2-2,0	
LCP40M	100-200	0,20-0,40	3,0-6,0	180-300	0,08-0,15	0,2-2,0	
LCP40M LCPK30M	100-200 130-220	0,20-0,40 0,15-0,30	3,0-6,0	150-250 180-300	0,08-0,15 0,08-0,10	0,2-2,0	
LCP40M LCPK30M	100-200 130-220	0,20-0,40 0,15-0,30	3,0-6,0	150-250 180-300	0,08-0,15 0,08-0,10	0,2-2,0	
LCP40M LCPK30M	100-200 130-220	0,20-0,40 0,15-0,30	3,0-6,0	150-250 180-300	0,08-0,15 0,08-0,10	0,2-2,0	
LCP40M LCPK30M	100-200 130-220	0,15-0,35 0,15-0,30	3,0-6,0	150-250 180-300	0,08-0,15 0,08-0,10	0,2-2,0	
LCM45M LCMS35M	80-120 160-220	0,15-0,25	1,0-3,0	80-120 160-240	0,05-0,15	0,2-1,0	
LCM45M LCMS35M	60-100 160-220	0,20-0,40	1,0-3,0	60-100 160-240	0,05-0,15	0,2-1,0	
LCKP10M	100-240	0,10-0,35	3,0-6,0	200-260	0,10-0,20	0,2-2,0	
LCKP10M	100-180	0,10-0,35	3,0-6,0	160-200	0,10-0,20	0,2-2,0	
LCKP10M	100-160	0,10-0,35	3,0-6,0	140-180	0,10-0,20	0,2-2,0	
LCKP10M	100-200	0,10-0,35	3,0-6,0	160-220	0,10-0,20	0,2-2,0	
LCN10M	400	0,30-0,40	3,0-6,0	400	0,10-0,20	0,2-2,0	
LWN10M	500-1000	0,30-0,40	3,0-6,0	500-1000	0,10-0,20	0,2-2,0	
LWN10M LCN10M	150-300	0,30-0,40	3,0-6,0	200-350	0,10-0,20	0,2-2,0	
LWN10M LCN10M	250-500	0,30-0,40	3,0-6,0	300-500	0,10-0,20	0,2-2,0	
LWN10M	180-300	0,30-0,40	3,0-6,0	200-400	0,10-0,20	0,2-2,0	
LWN10M	200-250	0,30-0,40	3,0-6,0	200-250	0,10-0,20	0,2-2,0	
LCMS35M	40-80	0,05-0,15	1,0-2,5	40-80	0,05-0,10	0,2-1,0	
LCMS35M	20-60	0,05-0,15	0,5-2,0	30-60	0,05-0,10	0,2-1,0	
LCMS35M	30-80	0,05-0,15	1,0-2,5	40-80	0,05-0,10	0,2-1,0	
LCMS35M	30-80	0,05-0,15	1,0-2,5	40-80	0,05-0,10	0,2-1,0	

Nassbearbeitung, auf ausreichende Emulsionszuführung achten
Wet machining, sufficient emulsion volume required

Trockenbearbeitung, Pressluftkühlung ist vorteilhaft
Dry machining, air-blast cooling is advantageous

Fräsen mit Wendeschneidplatten
Milling with indexable inserts

15° Spanwinkel für geringe Zerspanungskräfte
15° chipping angle for reduced machining forces

Schnitttiefe bis 4,0 mm
Depth of cut up to 4.0 mm

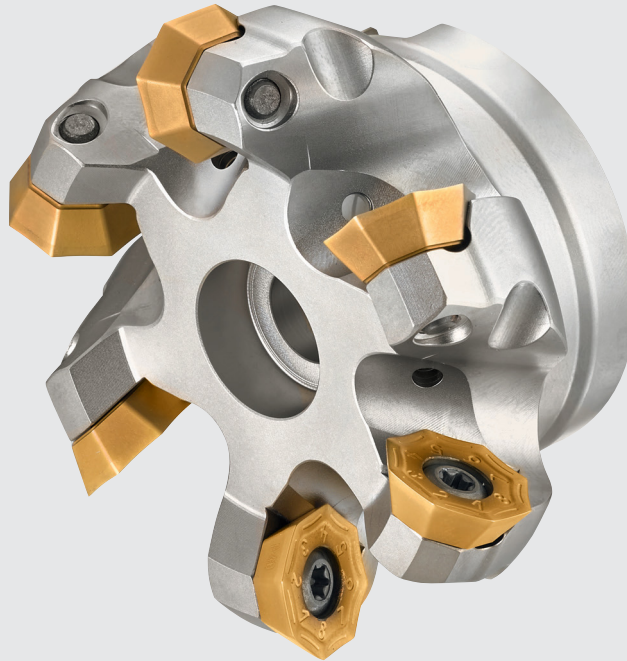

Schneidstoffe und Beschichtungen für lange Standzeiten und hohe Zerspanleistung
Cutting grades and coatings for a long tool life and high chipping volumes

Geometrien für die Bearbeitung von ISO-P, ISO-K, ISO-M und ISO-S
Geometries for the machining of ISO-P, ISO-K, ISO-M and ISO-S

Mit den MultiFace P45 PRO8 erweitert LMT Fette sein Produktprogramm um ein sehr weichschneidendes Wendepplattenfrässystem zum Schrumpfen und Schlichten von unterschiedlichsten Werkstoffen.

Je nach Anforderung gibt es eine Ausführung für Schnitttiefen bis 6 mm mit vierschneidiger Wendeschneidplatte oder eine Ausführung für Schnitttiefen bis 4 mm mit achtschneidiger Wendeschneidplatte.

Für die Zerspanung der unterschiedlichen Werkstoffe gibt es eigens entwickelte Geometrien und Schneidstoffe.

Im Durchmesserbereich von 50 bis 160 mm bietet das Standardprogramm jeweils eine normale sowie feine Teilung.

With the MultiFace P45 PRO8, LMT Fette is expanding its product range with a very soft cutting edge milling system for roughing and finishing different materials.

Depending on the requirements, there is a tool for a depth of cut up to 6 mm with four cutting edges per insert or with a depth of cut up to 4 mm with eight cutting edge per insert.

For the machining of different materials there are specially developed geometries and cutting materials.

In the diameter range from 50 to 160 mm, the standard program offers a normal as well as fine pitched version.

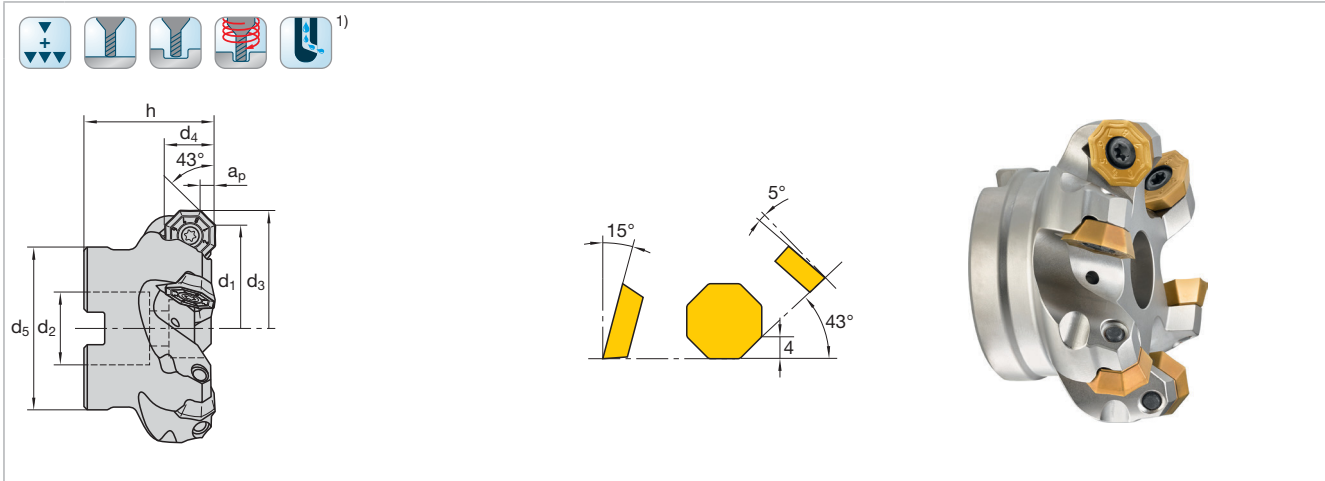

Katalog-Nr. Cat.-No.									FMP45			
d ₁	d ₃	d ₄	h	d ₂	d ₅	z	a _p max	Ident No.	LMT-Code			
50	60	16	40	22	40	4	4	7220260	FMP45 006.050AN-I	OEKT 06...	1045777	10488 T20
50	60	16	40	22	40	5	4	7220266	FMP45 006.050AN-IF			
63	73	16	40	22	50	5	4	7220261	FMP45 006.063AN-I			
63	73	16	40	22	50	6	4	7220267	FMP45 006.063AN-IF			
80	90	16	50	27	60	6	4	7220262	FMP45 006.080AN-I			
80	90	16	50	27	60	8	4	7220268	FMP45 006.080AN-IF			
100	110	16	50	32	75	7	4	7220263	FMP45 006.100AN-I			
100	110	16	50	32	75	10	4	7220269	FMP45 006.100AN-IF			
125	135	16	63	40	90	8	4	7220264	FMP45 006.125AN-I			
125	135	16	63	40	90	12	4	7220270	FMP45 006.125AN-IF			
160	170	16	63	40	130	10	4	7220265	FMP45 006.160AN			
160	170	16	63	40	130	15	4	7220271	FMP45 006.160AN-F			

¹⁾ IK Ø 50–125 mm
 IK Ø 50–125 mm

Schnittwertempfehlungen ab Seite 254
 Cutting data recommendations starting page 254



Planfräsoperation Gegenklappe
 Face milling operation bearing cap

Werkzeug Tool:
 MultiFace P45 PRO8 (Ident No. 7220267)
 Ø 63 mm, z = 6

Werkstoff Material:
 Kaltarbeitsstahl Cold work steel
 (1.2842; ~1000 N/mm²)

Wendepatte Insert:
 OEKT 0605AFSN in LCPK30M (Ident No. 7212189)

Schnittwerte Cutting data:
 v_c = 240 m/min a_p = 2 mm
 n = 1200 min⁻¹ a_e = 1–48 mm
 f_z = 0,15 mm

Ergebnis Result:
 Um 30 % höheres Zeitspanvolumen bei 50 % höherer Standzeit.
 Increased chipping volume by 30 % and 50 % higher tool life.



OEKT 0605 AE-SN

Merkmale:

- Höchste Schneidkantenstabilität
- Für ungünstige Bearbeitungsbedingungen
- Negative Schutzfase mit Schneidkantenverrundung

Features:

- Very stable geometry
- For challenging applications
- Negative chamfer with edge preparation

Spanformstufen
Chip-breaker

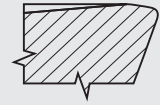

-SN



OEKT 0605 AEEN-BM

Merkmale:

- Leichtschneidende Geometrie zur Reduzierung der Zerspankräfte
- Für gute Bearbeitungsbedingungen
- 8° Spanwinkel und Schneidkantenverrundung

Features:

- Soft-cutting geometry
- For uncomplicated applications
- Additional 8° chipping angle with edge preparation

Spanformstufen
Chip-breaker

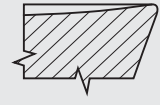

-BM



OEKT 0605 AESN-BMS

Merkmale:

- Universelle Geometrie für ein breites Anwendungsfeld
- Für mittlere Bearbeitungsbedingungen
- 15° Spanwinkel und negative Schutzfase mit Schneidkantenverrundung

Features:

- Universal geometry
- For cross-section applications
- Additional 15° chipping angle with edge preparation

Spanformstufen
Chip-breaker

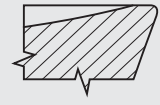

-BMS

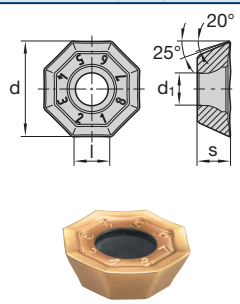
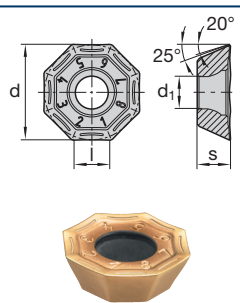
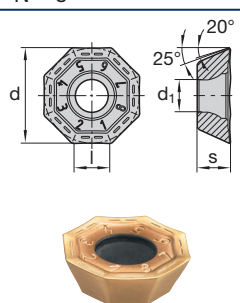
							Schneidstoffsorten Cutting materials											Für Fräser For cutter Cat-No.							
							Ident No.																		
N = Anzahl der Schneidkanten N = Number of cutting edges	ISO-Code	l	d	s	d ₁	r	LCP40M	LCPM40M	LCPK30M	LCP25M	LCPK10M	LCM45M	LCMS35M	LCKP30M	LCKP10M	LCK20M	LCK10M	LCN10M	LWN10M	LCHP15M	LCH50M				
 <p>N = 8</p>	OEKT 0605 AESN	6	15,88	5,56	5,5	-	7212188		7212189			7212190			7212191								FMP45		
 <p>N = 8</p>	OEKT 0605 AEEN-BM	6	15,88	5,56	5,5	-	7212192					7212193											FMP45		
 <p>N = 8</p>	OEKT 0605 AESN-BMS	6	15,88	5,56	5,5	-	7212194						7212195										FMP45		
■ = Hauptanwendung First choice □ = Nebenanwendung Alternative							■	■			□	□	■	■	■									P	
							□				■	■	■	■	■									M	
									□						□										K
																									N
													■												S
																									H

Sortenbeschreibung/-bezeichnung und ISO-Code ab Seite 424/477
 Description/Designation of grades and ISO-Code starting page 424/477

Fräsen mit Wendeschneidplatten
 Milling with indexable inserts

MultiFace P45 PRO8
Schnittwertempfehlungen
Cutting data recommendations

	Werkstoff	Material	Werkstoff-Nr. Material No.	DIN Bezeichnung Alt DIN Description Old	Rm/UTS (N/mm²)	DIN Bezeichnung Neu DIN Description New
P	Unlegierter Baustahl + Automatenstahl	Plain carbon steel + free cutting steel	1.0570	St52-3	-700	S355J2G3
			1.1730	C45	-800	C45U
			1.0715	9SMn28	-700	11SMn30
			1.1191	Ck45	500-950	C45E
			1.7219	26CrMo4		26CrMo4-2
	Vergütungsstahl, mittelfest	Heat-treatment steel, medium strength	1.7225	42CrMo4	500-950	42CrMo4
			1.8159	51CrV4		51CrV4
	Stahlguss	Cast steel	1.0416	GS40	-950	GS40
	Einsatzstahl	Case hardening steel	1.7131	16MnCr5	-950	16MnCr5
	Rost- und säurebe- ständiger Stahl, ferritisch, martensitisch	Stainless steel, ferritic, martensitic	1.4006	X10Cr13	500-950	X12Cr13
			1.4104	X12CrMoS17		X14CrMoS17
			1.4122	X35CrMo17		X39CrMo17-1
	Vergütungsstahl, hochfest	Heat-treatment steel, high strength	1.7225	42CrMo4	950-1400	42CrMo4
			1.6580	30CrNiMo8		30CrNiMo8
	Nitrierstahl, vergütet	Nitriding steel, heat treated	1.8504	34CrAl6	950-1400	34CrAl6
			1.2344	X40CrMoV5.1	-900	X40CrMoV5-1
	Werkzeugstahl	Tool steel	1.2311	40CrMnMo7	-1100	40CrMnMo7
1.2312			40CrMnNiMoS8.6	-1150	40CrMnNiMoS8-6	
1.2316			X38CrMo16	-1100	X38CrMo16	
1.2738			45CrMnNiMo8.6.4	950-1150	45CrMnNiMo8-6-4	
1.2343			X38CrMoV5 1	950-1400	X37CrMoV5-1	
1.2379			X155CrVMo12 1	-950	X153CrMoV12-1	
1.2358			60CrMoV18-5	850-1000	60CrMoV18-5	
1.2080			X210Cr12	950-1400	X210Cr12	
1.2714			55NiCrMoV7	1100-1350	55NiCrMoV7	
M	Rost- und säurebe- ständiger Stahl, austenitisch	Stainless steel, austenitic	1.4301	X2CrNiMo17-12-2	500-950	X5CrNiMo18-10
			1.4404	X6CrNiMoTi17-12-2		X2CrNiMo17-12-2
			1.4571	X10CrNiMoTi18		X10CrNiMoTi18
	Rost- und säurebe- ständiger Stahl, martensitisch aushärtbar	Stainless steel, martensitic steel	1.2709	X3NiCoMoTi18-9-5	800-1000	X3NiCoMoTi18-9-5
			1.4542	X5CrNiCuNb16-4		X5CrNiCuNb16-4
1.4568	X7CrNiAl17-7		X7CrNiAl17-7			
K	Grauguss	Grey cast iron	0.6025	GG25	100-400 120-260 HB)	EN-GJI-250
	Legierter Grauguss	Alloyed grey cast iron	0.6678	GGL-NiCr35 2	150-250 160-230 HB)	EN-GJLA-XNiCr35-2
	Sphäroguss	Nodular cast iron	0.7060	GGG60	400-800	EN-GJS-600-3
			0.7070	GGG70L	120-310 HB)	EN-GJS-700-2U
	Temperguss	Malleable cast iron	0.8155	GTS55	350-700 150-280 HB)	EN-GJMB-550-4
N	Aluminium-Legierungen, kurzspanend	Aluminium alloys, short chipping	3.2581	G-AlSi12	-400	G-IGK-AlSi12
	Aluminium-Legierungen, langspanend	Aluminium alloys, long chipping	3.3535	AlMg3	-550	AlMg3
			3.4365	AlZnMgCu1,5		AlZnMgCu1,5
	Kupfer-Legierungen, kurzspanend	Copper alloys, short chipping	2.0402	MS58	-500	CuZn40Pb2
	Kupfer-Legierungen, langspanend	Copper alloys, long chipping	2.0320	MS63	300-500	CuZn37
			2.0975	CuAl10Ni		CuAl10Fe5Ni5-C
	Thermoplaste	Thermoplastics		PVC	40-70	PVC
Duroplaste	Duroplastics		Bakelit, Melamin	20-40	Bakelit, Melamin	
S	Titan-Legierungen, mittelfest	Titanium alloys, medium strength	3.7115	TiAl5Sn2,5	-950	TiAl5Sn2-5
			3.7164	TiAl6V4		Ti6AlV4
	Titan-Legierungen, hochfest	Titanium alloys, high strength	3.7174	TiAl6Sn2	900-1400	TiAl6V6Sn2
	Nickelbasis-Legierungen, mittelfest	Nickel based alloys, medium strength	2.4670	NiCr12Al6MoNb	-950	NiCr12Al6MoNb
Nickelbasis-Legierungen, hochwarmfest	Heat resistant nickel based alloys, high strength	2.4668	NiCr19Fe19NbMo	900-1400	Inconel 718 NiCr19Fe19Nb5Mo3	

Die angegebenen Schnittwerte sind Startwerte und müssen auf die vorhandenen Bedingungen abgestimmt werden.
The cutting data indicated are starting values and must be adjusted to the prevailing conditions.

HM-Sorte Carbide grade	Vorschub pro Zahn Feed per tooth f_z (mm/min)					
	Schruppen Roughing 			Schlichten Finishing 		
	v_c (m/min)	f_z (mm/z)	a_p SE max 6 OE max 4	v_c (m/min)	f_z (mm/z.)	a_p
LCP40M LCPK30M	150-250 180-280	0,20-0,40 0,15-0,30	3,0-6,0	180-300 200-320	0,08-0,20 0,08-0,15	0,2-2,0
LCP40M LCPK30M	150-250 180-280	0,20-0,40 0,15-0,30	3,0-6,0	100-250 130-280	0,08-0,15 0,08-0,10	0,2-2,0
LCP40M	150-250	0,20-0,40	3,0-6,0	180-300	0,08-0,20	0,2-2,0
LCP40M	100-200	0,20-0,40	3,0-6,0	180-300	0,08-0,15	0,2-2,0
LCP40M LCPK30M	100-200 130-220	0,20-0,40 0,15-0,30	3,0-6,0	150-250 180-300	0,08-0,15 0,08-0,10	0,2-2,0
LCP40M LCPK30M	100-200 130-220	0,20-0,40 0,15-0,30	3,0-6,0	150-250 180-300	0,08-0,15 0,08-0,10	0,2-2,0
LCP40M LCPK30M	100-200 130-220	0,20-0,40 0,15-0,30	3,0-6,0	150-250 180-300	0,08-0,15 0,08-0,10	0,2-2,0
LCP40M LCPK30M	100-200 130-220	0,15-0,35 0,15-0,30	3,0-6,0	150-250 180-300	0,08-0,15 0,08-0,10	0,2-2,0
LCM45M LCMS35M	80-120 160-220	0,15-0,25	1,0-3,0	80-120 160-240	0,05-0,15	0,2-1,0
LCM45M LCMS35M	60-100 160-220	0,20-0,40	1,0-3,0	60-100 160-240	0,05-0,15	0,2-1,0
LCKP10M	100-240	0,10-0,35	3,0-6,0	200-260	0,10-0,20	0,2-2,0
LCKP10M	100-180	0,10-0,35	3,0-6,0	160-200	0,10-0,20	0,2-2,0
LCKP10M	100-160	0,10-0,35	3,0-6,0	140-180	0,10-0,20	0,2-2,0
LCKP10M	100-200	0,10-0,35	3,0-6,0	160-220	0,10-0,20	0,2-2,0
LCN10M	400	0,30-0,40	3,0-6,0	400	0,10-0,20	0,2-2,0
LWN10M	500-1000	0,30-0,40	3,0-6,0	500-1000	0,10-0,20	0,2-2,0
LWN10M LCN10M	150-300	0,30-0,40	3,0-6,0	200-350	0,10-0,20	0,2-2,0
LWN10M LCN10M	250-500	0,30-0,40	3,0-6,0	300-500	0,10-0,20	0,2-2,0
LWN10M	180-300	0,30-0,40	3,0-6,0	200-400	0,10-0,20	0,2-2,0
LWN10M	200-250	0,30-0,40	3,0-6,0	200-250	0,10-0,20	0,2-2,0
LCMS35M	40-80	0,05-0,15	1,0-2,5	40-80	0,05-0,10	0,2-1,0
LCMS35M	20-60	0,05-0,15	0,5-2,0	30-60	0,05-0,10	0,2-1,0
LCMS35M	30-80	0,05-0,15	1,0-2,5	40-80	0,05-0,10	0,2-1,0
LCMS35M	30-80	0,05-0,15	1,0-2,5	40-80	0,05-0,10	0,2-1,0

Nassbearbeitung, auf ausreichende Emulsionszuführung achten
Wet machining, sufficient emulsion volume required

Trockenbearbeitung, Pressluftkühlung ist vorteilhaft
Dry machining, air-blast cooling is advantageous

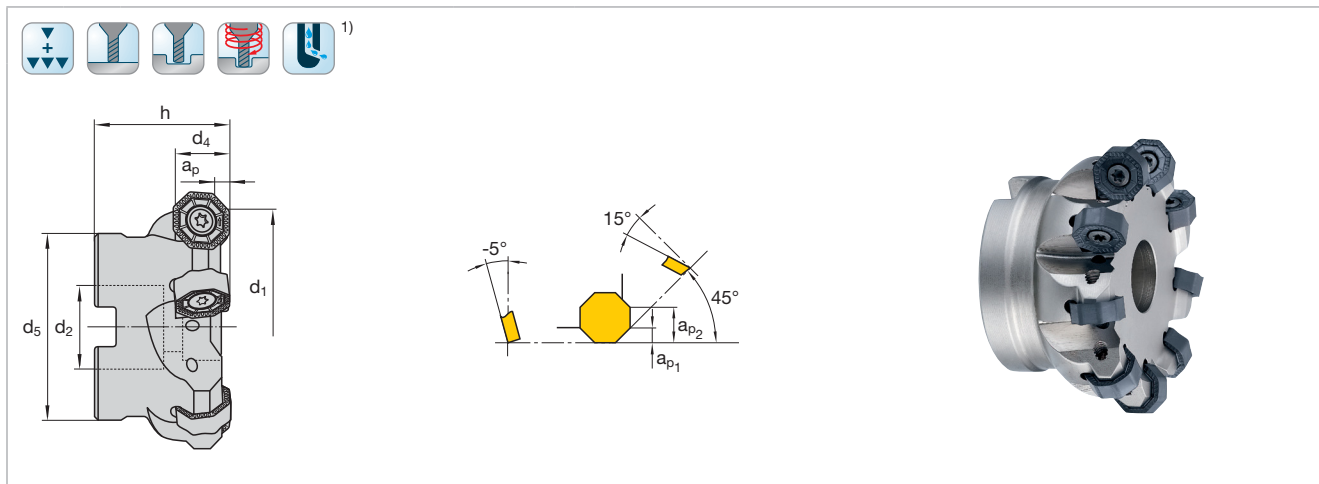

Katalog-Nr. Cat.-No.										FMN45 IK		
d ₁	d ₄	h	d ₅	d ₂	z	a _{p1}	a _{p2}	Ident No.	LMT-Code			
32	12,7	40	32	16	3	3	8	1027400	FMN45 O05.032AN-I	ON..05	1045131	1048335 T15
32	12,7	40	32	16	4	3	8	1027401	FMN45 O05.032AN-IF			
40	12,7	40	40	22	4	3	8	1027402	FMN45 O05.040AN-I			
40	12,7	40	40	22	5	3	8	1027403	FMN45 O05.040AN-IF			
50	12,7	40	40	22	5	3	8	1027404	FMN45 O05.050AN-I			
50	12,7	40	40	22	7	3	8	1027405	FMN45 O05.050AN-IF			
63	12,7	40	50	22	7	3	8	1027406	FMN45 O05.063AN-I			
63	12,7	40	50	22	9	3	8	1027407	FMN45 O05.063AN-IF			
50	16	40	40	22	4	4	10	1027420	FMN45 O06.050AN-I	ON..06	1045133	1048422 20 IP
50	16	40	40	22	6	4	10	1027421	FMN45 O06.050AN-IF			
63	16	40	50	22	5	4	10	1027422	FMN45 O06.063AN-I			
63	16	40	50	22	8	4	10	1027423	FMN45 O06.063AN-IF			
80	16	50	60	27	7	4	10	1027424	FMN45 O06.080AN-I			
80	16	50	60	27	10	4	10	1027425	FMN45 O06.080AN-IF			
100	16	50	75	32	9	4	10	1027426	FMN45 O06.100AN-I			
100	16	50	75	32	12	4	10	1027427	FMN45 O06.100AN-IF			
125	16	63	90	40	11	4	10	1027428	FMN45 O06.125AN			
125	16	63	90	40	15	4	10	1027429	FMN45 O06.125AN-F			
160	16	63	130	40	13	4	10	1027430	FMN45 O06.160AN	ON..08	1045133	1048422 20 IP
160	16	63	130	40	19	4	10	1027431	FMN45 O06.160AN-F			
63	20	50	50	27	5	5	12	7112376	FMN45 O08.063AN-I			
63	20	50	50	27	6	5	12	7112377	FMN45 O08.063AN-IF			
80	20	50	60	27	6	5	12	7112378	FMN45 O08.080AN-I			
80	20	50	60	27	8	5	12	7112379	FMN45 O08.080AN-IF			
100	20	50	75	32	7	5	12	7112380	FMN45 O08.100AN-I			
100	20	50	75	32	10	5	12	7112381	FMN45 O08.100AN-IF			
125	20	63	90	40	8	5	12	7112382	FMN45 O08.125AN			
125	20	63	90	40	12	5	12	7112383	FMN45 O08.125AN-F			
160	20	63	130	40	10	5	12	7112384	FMN45 O08.160AN	ON..08	1045133	1048422 20 IP
160	20	63	130	40	15	5	12	7112385	FMN45 O08.160AN-F			
200	20	63	170	60	12	5	12	7112386	FMN45 O08.200AN			
250	20	63	200	60	16	5	12	7112387	FMN45 O08.250AN			
315	20	80	-	60	20	5	12	7112388	FMN45 O08.315AN			

¹⁾ IK IC Ø 32-100

Fräser auch verfügbar in Zoll-Abmessungen
 Cutters also available in inch dimensions

Schnittwertempfehlungen siehe Seite 258
 Cutting data recommendations see page 258

		Schneidstoffsorten Cutting materials											Für Fräser For cutter Cat-No.														
		Ident No.																									
N = Anzahl der Schneidkanten N = Number of cutting edges	ISO-Code	l	d	s	d ₁	b	LCP40M	LCPM40M	LCPK30M	LCP25M	LCPK10M	LCM45M		LCM44M	LCKP30M	LCKP10M	LCK20M	LCK10M	LCN10M	LWN10M	LCHP15M	LCH50M					
 N = 16	ONGU 0505 ANEN	-	12,7	5,56	4,4	2	1054009			1054017					1054014		7048392						FMN45 IK				
	ONGU 0606 ANEN	-	16	6,35	6,3	2	1054008		1054015						1054013		7048393										
	ONGU 0807 ANEN	-	20	6,85	6,3	2	7114154 ²⁾																				
 N = 16	ONMU 0606 ANSN	-	16	6,35	6,3	2	7114151 ²⁾								7114150		7114149							FMN45 IK			
	ONMU 0807 ANSN	-	20	6,8	6,3	2	7114157 ²⁾								7114156		7114155										
 N = 16	ONMW 0605 ANSN	-	16	5,56	6,3	2									7114153		7114152							FMN45 IK			
	ONMW 0806 ANSN	-	20	6,35	6,3	2									7114159		7114158										
 N = 8 (ONGU) N = 4 (XNGU)	ONGU 0505 ANEN-SL	-	12,7	5,56	4,4	2									1054018 ¹⁾									FMN45 IK			
	ONGU 0606 ANEN-SL	-	16	6,35	6,3	2									1054016 ¹⁾												
	XNGU 0808 AN-Wiper	-	20	8,5	6,3	2								7114160													
■ = Hauptanwendung First choice □ = Nebenanwendung Alternative Sortenbeschreibung/-bezeichnung und ISO-Code ab Seite 424/477 Description/Designation of grades and ISO-Code starting page 424/477 ¹⁾ LCKP10M plus TiN-Decklage LCKP10M plus TiN top layer ²⁾ Nanomold Gold Nanomold Gold							■		■				□	□													P
							□		□																M		
															■	■	■	■								K	
																										N	
																										S	
																										H	

Fräsen mit Wendeschneidplatten
Milling with indexable inserts

MultiEdge Double8

Schnittwertempfehlungen

Cutting data recommendations

	Werkstoff	Material	Werkstoff-Nr. Material No.	DIN Bezeichnung Alt DIN Description Old	R _m /UTS (N/mm ²)	DIN Bezeichnung Neu DIN Description New
P	Unlegierter Baustahl + Automatenstahl	Plain carbon steel + free cutting steel	1.0570	St52-3	-700	S355J2G3
			1.1730	C45	-800	C45U
			1.0715	9SMn28	-700	11SMn30
			1.1191	Ck45	500-950	C45E
			1.7219	26CrMo4	500-950	26CrMo4-2
	Vergütungsstahl, mittelfest	Heat-treatment steel, medium strength	1.7225	42CrMo4	500-950	42CrMo4
			1.8159	51CrV4	500-950	51CrV4
	Stahlguss	Cast steel	1.0416	GS40	-950	GS40
	Einsatzstahl	Case hardening steel	1.7131	16MnCr5	-950	16MnCr5
	Rost- und säurebe- ständiger Stahl, ferritisch, martensitisch	Stainless steel, ferritic, martensitic	1.4006	X10Cr13	500-950	X12Cr13
			1.4104	X12CrMoS17	500-950	X14CrMoS17
			1.4122	X35CrMo17	500-950	X39CrMo17-1
	Vergütungsstahl, hochfest	Heat-treatment steel, high strength	1.7225	42CrMo4	950-1400	42CrMo4
			1.6580	30CrNiMo8	950-1400	30CrNiMo8
	Nitrierstahl, vergütet	Nitriding steel, heat treated	1.8504	34CrAl6	950-1400	34CrAl6
			1.2344	X40CrMoV5.1	-900	X40CrMoV5-1
	Werkzeugstahl	Tool steel	1.2343	X38CrMoV5 1	950-1400	X37CrMoV5-1
1.2379			X155CrVMo12 1	-950	X153CrMoV12-1	
1.2358			60CrMoV18-5	850-1000	60CrMoV18-5	
1.2080			X210Cr12	950-1400	X210Cr12	
1.2714			55NiCrMoV7	1100-1350	55NiCrMoV7	
1.2311			40CrMnMo7	-1100	40CrMnMo7	
1.2312			40CrMnNiMoS8.6	-1150	40CrMnNiMoS8-6	
1.2316			X38CrMo16	-1100	X38CrMo16	
1.2738	45CrMnNiMo8.6.4	950-1150	45CrMnNiMo8-6-4			
K	Grauguss	Grey cast iron	0.6025	GG25	100-400 (120-260 HB)	EN-GJL-250
			0.6678	GGL-NiCr35 2	150-250 (160-230 HB)	EN-GJLA-XNiCr35-2
	Sphäroguss	Nodular cast iron	0.7060	GGG60	400-800	EN-GJS-600-3
			0.7070	GGG70L	(120-310 HB)	EN-GJS-700-2U
Temperguss	Malleable cast iron	0.8155	GTS55	350-700 (150-280 HB)	EN-GJMB-550-4	

Die angegebenen Schnittwerte sind Startwerte und müssen auf die vorhandenen Bedingungen abgestimmt werden.
The cutting data indicated are starting values and must be adjusted to the prevailing conditions.

Weichschneidende Wendeschneidplatten-Geometrie zur Reduzierung der Zerspankräfte. Umfangsgeschliffene Wendeschneidplatte mit Schneidkantenverrundung. Einsatz für Stähle mittlerer Festigkeit und Gusswerkstoffe. Besonders geeignet für Werkzeugmaschinen mit geringerer Antriebsleistung.

Soft cutting insert geometry for reduced cutting forces. Peripheral ground indexable insert with rounded cutting edges. Can be used for medium strength steels and for cast materials. Particularly suited for machine tools with low drive power.

ONGU_EN

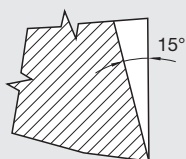

Universelle Wendeschneidplatten-Geometrie für ein breites Anwendungsfeld. Schneidkante mit negativer Schutzfase für erhöhte Stabilität. Einsatz für Stähle mittlerer und höherer Festigkeit, rostfreie Stähle, sowie Grau- und Sphäroguss.

Universal insert geometry for a broad range of applications. Cutting edge with negative protection chamfer for increased stability. Can be used for medium and higher strength steels and stainless steels as well as gray iron and spheroidal graphite iron.

ONMU_SN

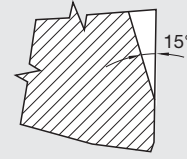

Schnittgeschwindigkeit Cutting speed v_c (m/min)	Empfohlene maximale Zahnvorschübe Recommended max. feed per tooth f_z (mm) bei with $a_p = 0,75 \times d_1$		
	FMN45		
	ON ... 05	ON ... 06	ON ... 08
	$a_{pmax.} = 3 \text{ mm}$	$a_{pmax.} = 4 \text{ mm}$	$a_{pmax.} = 5 \text{ mm}$
	f_z	f_z	f_z
200-240	0,40-0,45	0,45-0,50	0,50-0,55
180-200	0,35	0,40	0,45
140-160	0,30	0,35	0,40
140-180	0,30	0,35	0,40
120-150	0,20-0,25	0,30-0,35	0,30-0,40
120-160	0,25	0,30	0,35
120-140	0,25	0,30	0,35
120-140	0,20	0,25	0,30
200-260	0,45	0,50	0,55
160-200	0,30	0,35	0,40
140-180	0,35	0,40	0,45
160-200	0,35	0,40	0,45

Fräsen mit Wendeschneidplatten
Milling with indexable inserts

Stabile Wendeschneidplatten-Geometrie für die Hochleistungsersparnis von Grau- und Sphäroguss. Negative Schutzfase mit Schneidkantenverrundung optimal für den Einsatz auf leistungsstarken Maschinen. Stable insert geometry for high-performance machining of gray iron and spheroidal graphite iron. Negative protective chamfer with rounded cutting edge, ideally suited for use with high performance machines.

ONMW_SN

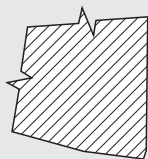
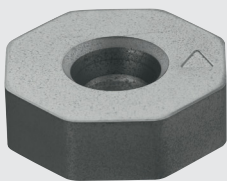

Breitschicht-Wendeschneidplatten-Geometrie für ein breites Anwendungsfeld. Umfangsgeschliffene Wendeschneidplatten mit Schneidkantenverrundung. Einsatz für Stähle mittlerer Festigkeit und Gusswerkstoffe.

Wiper insert geometry for a broad range of applications. Periphery ground indexable insert with rounded cutting edges. Can be used for medium strength steels and for cast materials.

XNGU

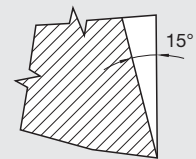

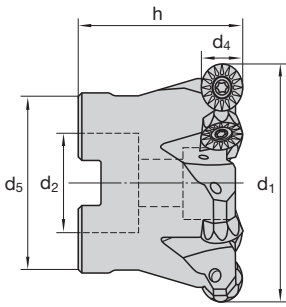

OCKX 0505

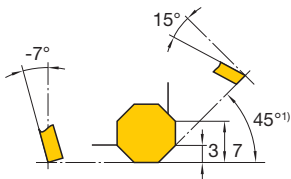

RCKX 1205

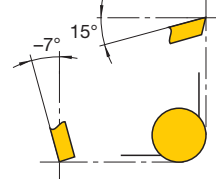

SAHT 1005

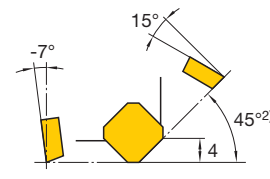

XCKX 1606

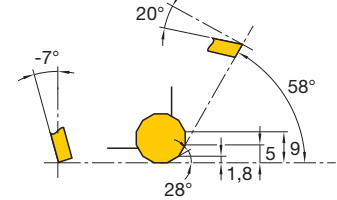

OCKX 0606

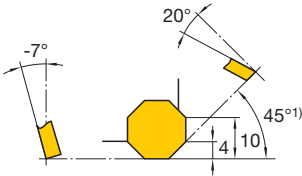

RCKX 1606

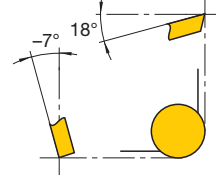

SAHT 1306

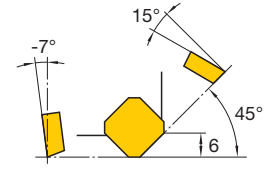

XOKX 1606

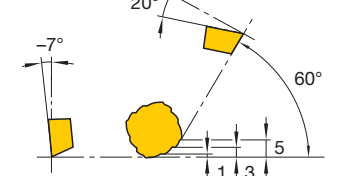

Katalog-Nr. Cat.-No.

FCT45

d ₁	d ₄	h	d ₅	d ₂	z	Ident No.	LMT-Code							
42	12	40	32	16	4	1041007	FCT45 005.042AN-I	OCKX 0505	RCKX 1205	SAHT 1005			1045131	1048335 T15
52	12	40	40	22	5	1041008	FCT45 005.052AN-I							
66	12	50	50	27	6	1041009	FCT45 005.066AN-I							
80	12	50	60	27	7	1041010	FCT45 005.080AN-I							
52	16	40	40	22	4	1041011	FCT45 006.052AN-I	OCKX 0606	RCKX 1606	SAHT 1306	XCKX 1606	XOKX 1606	1045777	1048344 T20
66	16	50	50	27	5	1041012	FCT45 006.066AN-I							
80	16	50	60	27	6	1041013	FCT45 006.080AN-I							
100	16	50	65	32	7	1041014	FCT45 006.100AN-I							
125	16	63	90	40	8	1041015	FCT45 006.125AN							
160	16	63	95	40	9	4053555	FCT45 006.160AN							

¹⁾ IK IC Ø 42–100

²⁾ Winkel am Werkstück 43°
 Angle on workpiece 43°

Schnittwertempfehlungen ab Seite 264
 Cutting data recommendations starting page 264

N = Anzahl der Schneidkanten N = Number of cutting edges	ISO-Code	l	d	s	d ₁	b	Schneidstoffsorten Cutting materials Ident No.											Für Fräser For cutter Cat-No.																																																																																																																																																											
							LCP40M	LCPM40M	LCPK30M	LCP25M	LCPK10M	LCM45M	LCM44M	LCKP30M	LCKP10M	LCK20M	LCK10M		LCN10M	LWN10M	LCHP15M	LCH50M																																																																																																																																																							
 N = 8	OCKX 0505 AD-TR	12	12	5,56	4,4	0,5	1054050	7002759			7002761				1054055	7047992							FCT45																																																																																																																																																						
 N = 8	OCKX 0606 AD-TR	16	16	6,35	5,8	0,5	1054003	7002774			7002770	7002781			1054005	7047993								FCT45																																																																																																																																																					
	OCKX 0606 AD-TRT	16	16	6,35	5,8	0,5		7002782							1054011	7047994																																																																																																																																																													
 	RCKX 1205 MO-TR	-	12	5,56	4,4	-	1068470	7002749			7002758				1068475	7047995								FCT45																																																																																																																																																					
 	RCKX 1606 MO-TR	-	16	6,35	5,8	-	1068433	7002762			7002764	7002763			1068435	7047996								FCT45																																																																																																																																																					
	RCKX 1606 MO-TRT	-	16	6,35	5,8	-		7002767		7002768					1068464	7047997																																																																																																																																																													
■ = Hauptanwendung First choice □ = Nebenanwendung Alternative Sortenbeschreibung/-bezeichnung und ISO-Code ab Seite 424/477 Description/Designation of grades and ISO-Code starting page 424/477							<table border="1"> <tr><td>■</td><td>■</td><td>■</td><td>■</td><td>□</td><td></td><td></td><td></td><td></td><td></td><td></td><td></td><td></td><td></td><td></td><td></td><td></td><td></td><td></td><td></td><td></td><td></td><td></td><td></td><td>P</td></tr> <tr><td>□</td><td>□</td><td>□</td><td></td><td></td><td></td><td></td><td></td><td></td><td></td><td></td><td></td><td></td><td></td><td></td><td></td><td></td><td></td><td></td><td></td><td></td><td></td><td></td><td></td><td></td><td>M</td></tr> <tr><td></td><td></td><td></td><td></td><td></td><td></td><td></td><td></td><td></td><td></td><td>□</td><td></td><td></td><td></td><td>■</td><td>■</td><td></td><td></td><td></td><td></td><td></td><td></td><td></td><td></td><td></td><td>K</td></tr> <tr><td></td><td></td><td></td><td></td><td></td><td></td><td></td><td></td><td></td><td></td><td></td><td></td><td></td><td></td><td></td><td></td><td></td><td></td><td></td><td></td><td></td><td></td><td></td><td></td><td></td><td>N</td></tr> <tr><td></td><td></td><td></td><td></td><td></td><td></td><td></td><td></td><td></td><td></td><td></td><td></td><td></td><td></td><td></td><td></td><td></td><td></td><td></td><td></td><td></td><td></td><td></td><td></td><td></td><td>S</td></tr> <tr><td></td><td></td><td></td><td></td><td></td><td></td><td></td><td></td><td></td><td></td><td></td><td></td><td></td><td></td><td></td><td></td><td></td><td></td><td></td><td></td><td></td><td></td><td></td><td></td><td></td><td>H</td></tr> </table>											■	■	■	■	□																				P	□	□	□																							M											□				■	■										K																										N																										S																										H	
■	■	■	■	□																				P																																																																																																																																																					
□	□	□																							M																																																																																																																																																				
										□				■	■										K																																																																																																																																																				
																									N																																																																																																																																																				
																									S																																																																																																																																																				
																									H																																																																																																																																																				

Fräsen mit Wendeschneidplatten
Milling with indexable inserts

							Schneidstoffsorten Cutting materials										Für Fräser For cutter Cat-No.										
							Ident No.																				
N = Anzahl der Schneidkanten N = Number of cutting edges	ISO-Code	l	d	s	d ₁	b/r	LCP40M	LCPM40M	LCPK30M	LCP25M	LCPK10M	LCM45M	LCM44M	LCKP30M	LCKP10M	LCK20M		LCK10M	LCN10M	LWN10M	LCHP15M	LCH50M					
 N = 4	SAHT 1005 AA ER	10	10	5,56	4,4	0,8	9197815				7002745				9197816		7048354		9206753			FCT45					
	SAHT 1306 AA EN	13,5	13,5	6,35	5,5	0,8	1054040				7002747				1054045		7048355		9206774								
 N = 12	XCKX 1606 ZDR-TR	16	16	6,35	5,8	0,5	1055677				7002783				1055678								FCT45				
	XOKX 1606 ZD-TR	16	16	6,35	5,8	0,5	1054021	1054023		1054020	1054024				1054022								FCT45				
■ = Hauptanwendung First choice □ = Nebenanwendung Alternative Sortenbeschreibung/-bezeichnung und ISO-Code ab Seite 424/477 Description/Designation of grades and ISO-Code starting page 424/477							■	■	■	■						□											P
							□	□	□																M		
										□					■		■								K		
																					■				N		
																									S		
																									H		

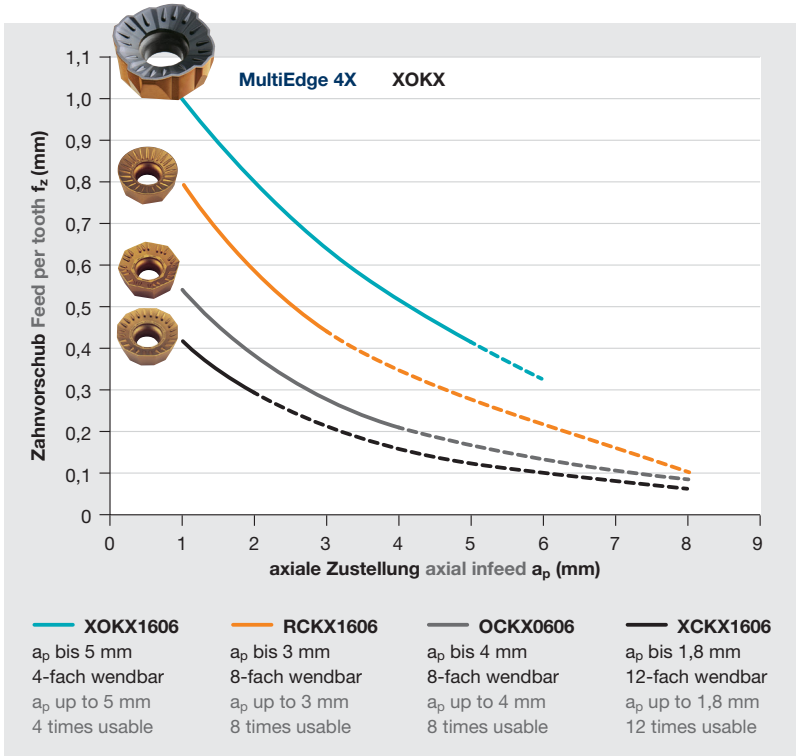

Zahnvorschub des MultiEdge 4X verglichen mit anderen Plattenausführungen
Feed per tooth of MultiEdge 4X compared with other inserts shape

MultiEdge 4X: Kleine Späne durch Spanteilung
MultiEdge 4X: Small chips because of chip division

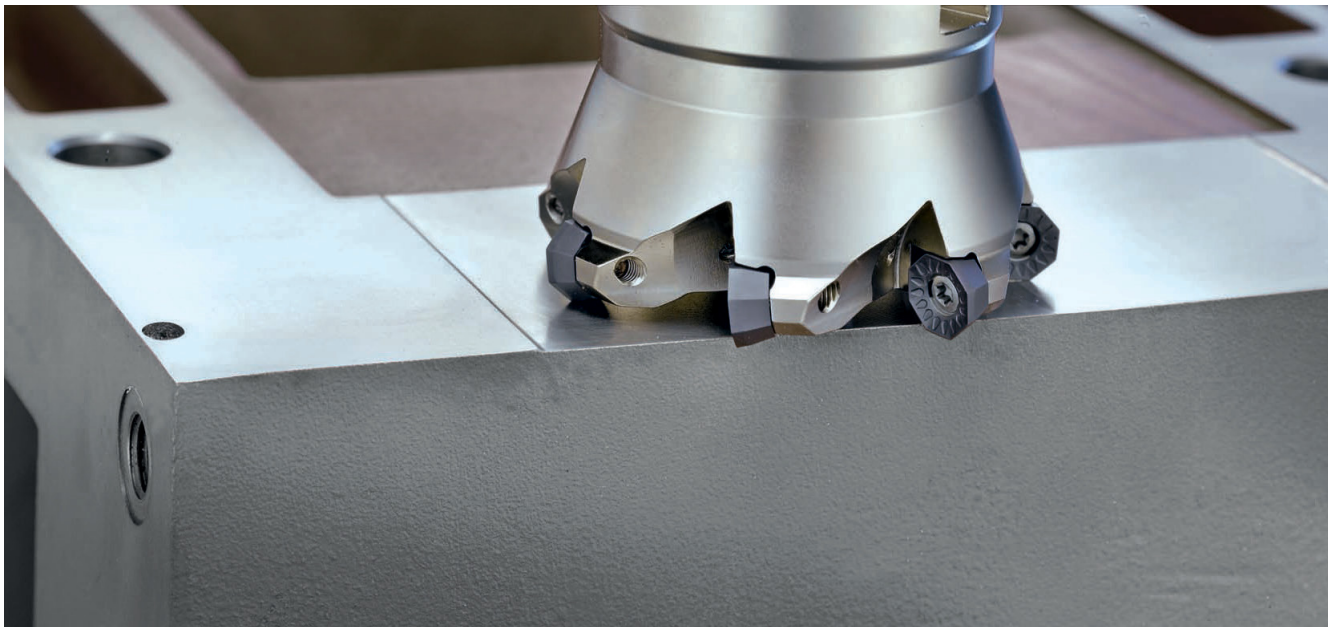

Fräsen mit Wertschneidplatten
Milling with indexable inserts

MultiEdge 45°
Schnittwertempfehlungen
Cutting data recommendations

	Werkstoff	Material	Werkstoff-Nr. Material No.	DIN Bezeichnung Alt DIN Description Old	R_m/UTS (N/mm²)	DIN Bezeichnung Neu DIN Description New
P	Unlegierter Baustahl + Automatenstahl	Plain carbon steel + free cutting steel	1.0570	St52-3	-700	S355J2G3
			1.1730	C45	-800	C45U
			1.0715	9SMn28	-700	11SMn30
			1.1191 1.7219	Ck45 26CrMo4	500-950	C45E 26CrMo4-2
	Vergütungsstahl, mittelfest	Heat-treatment steel, medium strength	1.7225	42CrMo4	500-950	42CrMo4
			1.8159	51CrV4		51CrV4
	Stahlguss	Cast steel	1.0416	GS40	-950	GS40
	Einsatzstahl	Case hardening steel	1.7131	16MnCr5	-950	16MnCr5
			Rost- und säurebe- ständiger Stahl, ferritisch, martensitisch	Stainless steel, ferritic, martensitic	1.4006	X10Cr13
	1.4104	X12CrMoS17				X14CrMoS17
	1.4122	X35CrMo17				X39CrMo17-1
	Vergütungsstahl, hochfest	Heat-treatment steel, high strength	1.7225	42CrMo4	950-1400	42CrMo4
			1.6580	30CrNiMo8		30CrNiMo8
	Nitrierstahl, vergütet	Nitriding steel, heat treated	1.8504	34CrAl6	950-1400	34CrAl6
			1.2344	X40CrMoV5.1	-900	X40CrMoV5-1
	Werkzeugstahl	Tool steel	1.2311	40CrMnMo7	-1100	40CrMnMo7
			1.2312	40CrMnNiMoS8.6	-1150	40CrMnNiMoS8-6
1.2316			X38CrMo16	-1100	X38CrMo16	
1.2738			45CrMnNiMo8.6.4	950-1150	45CrMnNiMo8-6-4	
1.2343			X38CrMoV5 1	950-1400	X37CrMoV5-1	
1.2379			X155CrVMo12 1	-950	X153CrMoV12-1	
1.2358			60CrMoV18-5	850-1000	60CrMoV18-5	
1.2080 1.2714			X210Cr12 55NiCrMoV7	950-1400 1100-1350	X210Cr12 55NiCrMoV7	
M	Rost- und säurebe- ständiger Stahl, austenitisch	Stainless steel, austenitic	1.4301	X2CrNiMo17-12-2	500-950	X5CrNiMo18-10
			1.4404	X6CrNiMoTi17-12-2		X2CrNiMo17-12-2
			1.4571	X10CrNiMoTi18		X10CrNiMoTi18
Rost- und säurebe- ständiger Stahl, martensitisch aushärtbar	Stainless steel, martensitic steel	1.2709	X3NiCoMoTi18-9-5	800-1000	X3NiCoMoTi18-9-5	
		1.4542	X5CrNiCuNb16-4		X5CrNiCuNb16-4	
		1.4568	X7CrNiAl17-7		X7CrNiAl17-7	
K	Grauguss	Grey cast iron	0.6025	GG25	100-400 (120-260 HB)	EN-GJL-250
	Legierter Grauguss	Alloyed grey cast iron	0.6678	GGL-NiCr35 2	150-250 (160-230 HB)	EN-GJLA-XNiCr35-2
	Sphäroguss	Nodular cast iron	0.7060	GGG60	400-800	EN-GJS-600-3
			0.7070	GGG70L	(120-310 HB)	EN-GJS-700-2U
Temperguss	Malleable cast iron	0.8155	GTS55	350-700 (150-280 HB)	EN-GJMB-550-4	
N	Aluminium-Legierungen, kurzspanend	Aluminium alloys, short chipping	3.2581	G-AISi12	-400	G-IGK-AISi12
	Aluminium-Legierungen, langspanend	Aluminium alloys, long chipping	3.3535 3.4365	AlMg3 AlZnMgCu1,5	-550	AlMg3 AlZnMgCu1,5
	Kupfer-Legierungen, kurzspanend	Copper alloys, short chipping	2.0402	MS58	-500	CuZn40Pb2
	Kupfer-Legierungen, langspanend	Copper alloys, long chipping	2.0320 2.0975	MS63 CuAl10Ni	300-500	CuZn37 CuAl10Fe5Ni5-C
	Thermoplaste	Thermoplastics		PVC	40-70	PVC
	Duroplaste	Duroplastics		Bakelit, Melamin	20-40	Bakelit, Melamin
S	Titan-Legierungen, mittelfest	Titanium alloys, medium strength	3.7115 3.7164	TiAl5Sn2,5 TiAl6V4	-950	TiAl5Sn2-5 TiAl6V4
	Titan-Legierungen, hochfest	Titanium alloys, high strength	3.7174	TiAl6Sn2	900-1400	TiAl6V6Sn2
	Nickelbasis-Legierungen, mittelfest	Nickel based alloys, medium strength	2.4670	NiCr12Al6MoNb	-950	NiCr12Al6MoNb
	Nickelbasis-Legierungen, hochwarmfest	Heat resistant nickel based alloys, high strength	2.4668	NiCr19Fe19NbMo	900-1400	Inconel 718 NiCr19Fe19Nb5Mo3

¹⁾ bei der SAHT 1005 auf a_p = 2 mm und bei der SAHT 1306 auf a_p = 3 mm
for SAHT 1005 with a_p = 2 mm and for SAHT 1306 with a_p = 3 mm

Maximale Zahnvorschübe f_z in mm bei $a_e = 0,75 \times d_1$ Max. feed per tooth f_z with $a_e = 0,75 \times d_1$ (d_1 = Fräserdurchmesser Cutter diameter)					
Planfräsen Face milling			Kopierfräsen Copy milling		
v_c (m/min)	SAHT 1005 ¹⁾ SAHT 1306 ¹⁾	OCKX 0505 OCKX 0606 XCKX 1606	v_c (m/min)	RCKX 1205	RCKX 1606 XOKX 1606
160–220	0,40	0,50	250–300	0,40	0,50
160–220	0,40	0,45	250–300	0,40	0,45
140–180	0,35	0,40	200–250	0,35	0,40
140–180	0,30	0,35	200–250	0,30	0,35
140–180	0,25	0,30	200–250	0,25	0,30
120–150	0,25	0,30	180–220	0,25	0,30
120–150	0,25	0,30	180–220	0,25	0,30
120–150	0,20	0,25	180–220	0,20	0,25
140–180	0,35	0,40	200–250	0,35	0,40
120–150	0,20	0,25	180–220	0,20	0,25
180–240	0,20	0,25	180–240	0,25	0,30
200–260	0,40	0,50	250–300	0,40	0,50
160–200	0,30	0,35	180–250	0,30	0,35
140–180	0,35	0,40	160–250	0,35	0,40
160–200	0,35	0,40	200–300	0,35	0,40
400	0,30–0,40	0,30–0,40	400	0,30–0,40	0,35–0,50
500–1200	0,30–0,40	0,30–0,40	500–1200	0,30–0,40	0,35–0,50
300	0,30–0,40	0,30–0,40	300	0,30–0,40	0,35–0,45
500	0,30–0,40	0,30–0,40	500	0,30–0,40	0,35–0,45
400	0,30–0,40	0,30–0,40	400	0,30–0,40	0,35–0,45
250	0,30–0,40	0,30–0,40	250	0,30–0,40	0,35–0,45
60–80	0,15–0,20	0,20–0,30	60–80	0,15–0,20	0,20–0,30
40–60	0,10–0,15	0,10–0,20	40–60	0,10–0,20	0,10–0,20
40–60	0,15–0,20	0,20–0,30	40–60	0,15–0,20	0,20–0,30
20–40	0,10–0,15	0,10–0,20	20–40	0,10–0,20	0,10–0,20

Fräsen mit Wendeschneidplatten
Milling with indexable inserts

Die angegebenen Schnittwerte sind Startwerte und müssen auf die vorhandenen Bedingungen abgestimmt werden.
The cutting data indicated are starting values and must be adjusted to the prevailing conditions.

Die f_z -Werte beziehen sich auf die in der Tabelle angegebenen Schnitttiefen a_p .
The f_z -values are quoted with respect to the depths of cut a_p specified in the table.

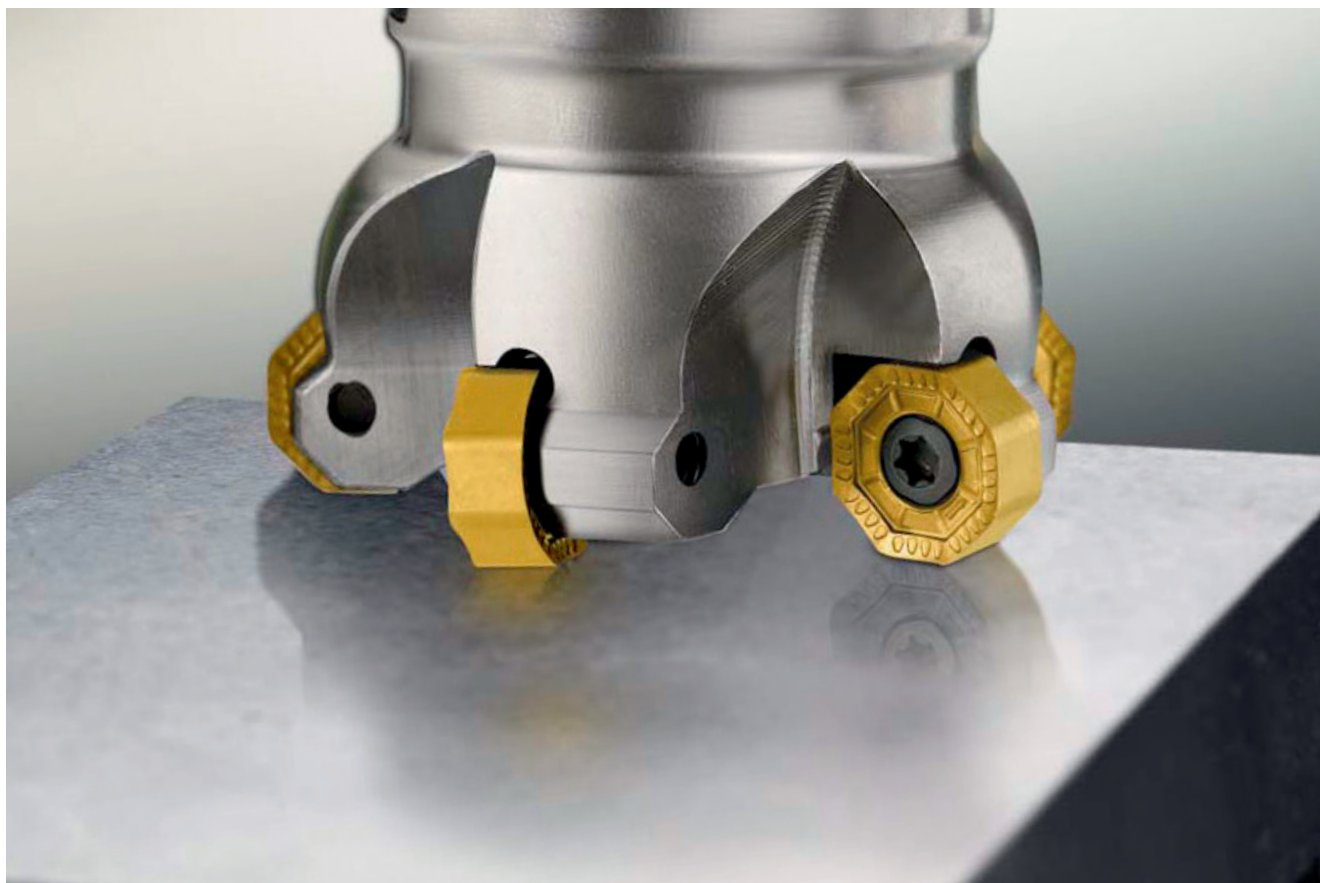

Fräsen mit Wertschneidplatten
Milling with indexable inserts

MultiEdge-VA
Schnittwertempfehlungen
Cutting data recommendations

	Werkstoff	Material	Werkstoff-Nr. Material No.	DIN Bezeichnung Alt DIN Description Old	R_m/UTS (N/mm²)	DIN Bezeichnung Neu DIN Description New
P	Unlegierter Baustahl + Automatenstahl	Plain carbon steel + free cutting steel	1.0570	St52-3	-700	S355J2G3
			1.1730	C45	-800	C45U
			1.0715	9SMn28	-700	11SMn30
			1.1191	Ck45	500-950	C45E
			1.7219	26CrMo4	500-950	26CrMo4-2
	Vergütungsstahl, mittelfest	Heat-treatment steel, medium strength	1.7225	42CrMo4	500-950	42CrMo4
			1.8159	51CrV4	500-950	51CrV4
	Rost- und säurebe- ständiger Stahl, ferritisch, martensitisch	Stainless steel, ferritic, martensitic	1.4006	X10Cr13	500-950	X12Cr13
			1.4104	X12CrMoS17	500-950	X14CrMoS17
			1.4122	X35CrMo17	500-950	X39CrMo17-1
M	Rost- und säurebe- ständiger Stahl, austenitisch	Stainless steel, austenitic	1.4301	X2CrNiMo17-12-2	500-950	X5CrNiMo18-10
			1.4404	X6CrNiMoTi17-12-2	500-950	X2CrNiMo17-12-2
			1.4571	X10CrNiMoTi18	500-950	X10CrNiMoTi18
	Rost- und säurebe- ständiger Stahl, martensitisch aushärtbar	Stainless steel, martensitic steel	1.2709	X3NiCoMoTi18-9-5	800-1000	X3NiCoMoTi18-9-5
			1.4542	X5CrNiCuNb16-4	800-1000	X5CrNiCuNb16-4
			1.4568	X7CrNiAl17-7	800-1000	X7CrNiAl17-7
N	Aluminium-Legierungen, langspanend	Aluminium alloys, long chipping	3.3535	AlMg3	-550	AlMg3
			3.4365	AlZnMgCu1,5	-550	AlZnMgCu1,5
	Kupfer-Legierungen, langspanend	Copper alloys, long chipping	2.0320	MS63	300-500	CuZn37
			2.0975	CuAl10Ni	300-500	CuAl10Fe5Ni5-C
S	Titan-Legierungen, mittelfest	Titanium alloys, medium strength	3.7115	TiAl5Sn2,5	-950	TiAl5Sn2-5
			3.7164	TiAl6V4	-950	Ti6AlV4
	Titan-Legierungen, hochfest	Titanium alloys, high strength	3.7174	TiAl6Sn2	900-1400	TiAl6V6Sn2

¹⁾ Schnittwert für Nasszerspanung



Cutting data for wet milling

²⁾ Die f_z -Werte beziehen sich auf die Schnitttiefen für $a_p = 2$ mm (SAHT 1005) und $a_p = 3$ mm (SAHT 1306)

The f_z values depend with respect to the depths of cut for $a_p = 2$ mm (SAHT 1005) and $a_p = 3$ mm (SAHT 1306)

Die angegebenen Schnittwerte sind Startwerte und müssen auf die vorhandenen Bedingungen abgestimmt werden.

The cutting data indicated are starting values and must be adjusted to the prevailing conditions.

Schnittgeschwindigkeit Cutting speed v_c (m/min)	Maximale Zahnvorschübe f_z in mm bei $a_e = 0,75 \times d_1$ Max. feed per tooth f_z with $a_e = 0,75 \times d_1$ (d_1 = Fräserdurchmesser Cutter diameter)	
	SAHT 1005 ²⁾	SAHT 1306 ²⁾
160–220	0,45	0,45
140–180	0,40	0,40
140–170	0,30	0,30
200–280 60–120 ¹⁾ 	0,25	0,25
180–240 60–120 ¹⁾ 	0,20	0,25
300–1000	0,40	0,40
250–500	0,40	0,40
40–80 ¹⁾	0,10	0,15
30–40 ¹⁾	0,10	0,15

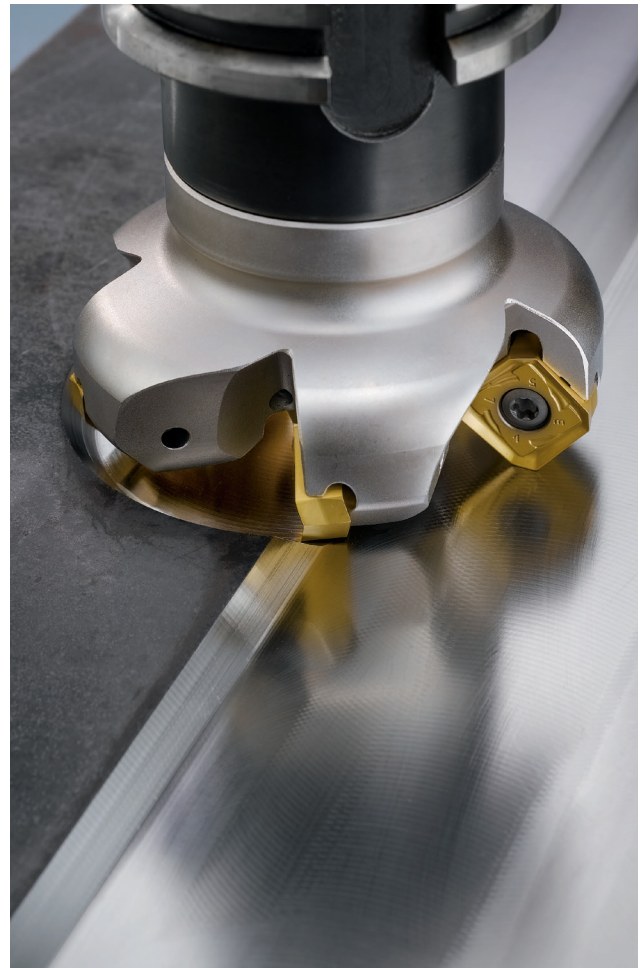

 Nassbearbeitung, auf ausreichende Emulsionszuführung achten
Wet machining, sufficient emulsion volume required



Zwischenplatte (Maschinenbau)
Intermediate plate (Machine construction)

Werkzeug Tool:

MultiEdge 45 Double4

Kat.-Nr. Cat.-No. FMP45, $d_1 = 63 \text{ mm}$, $z = 5$

Wendeplatte Insert:

SOKX 1505 ABER | LCP35M

Werkstoff Material:

1.0570 / St 52-3 / Zugfestigkeit $R_m 520 \text{ N/mm}^2$

1.0570 / St 52-3 / Tensile strength $R_m 520 \text{ N/mm}^2$

Schnittwerte Cutting data:

$v_c = 210 \text{ m/min}$

$n = 1050 \text{ m/min}^{-1}$

$f_z = 0,35 \text{ mm}$

$v_f = 1850 \text{ mm/min}$

$a_e = 50 \text{ mm}$

$a_p = 4 \text{ mm}$

Kühlung Coolant:

trocken dry

MultiEdge 45 Double4
Schnittwertempfehlungen
Cutting data recommendations

	Werkstoff	Material	Werkstoff-Nr. Material No.	DIN Bezeichnung Alt DIN Description Old	R_m/UTS (N/mm²)	DIN Bezeichnung Neu DIN Description New
P	Unlegierter Baustahl + Automatenstahl	Plain carbon steel + free cutting steel	1.0570	St52-3	-700	S355J2G3
			1.1730	C45	-800	C45U
			1.0715	9SMn28	-700	11SMn30
			1.1191	Ck45	500-950	C45E
			1.7219	26CrMo4	500-950	26CrMo4-2
	Vergütungsstahl, mittelfest	Heat-treatment steel, medium strength	1.7225	42CrMo4	500-950	42CrMo4
			1.8159	51CrV4	500-950	51CrV4
	Stahlguss	Cast steel	1.0416	GS40	-950	GS40
	Einsatzstahl	Case hardening steel	1.7131	16MnCr5	-950	16MnCr5
	Rost- und säurebe- ständiger Stahl, ferritisch, martensitisch	Stainless steel, ferritic, martensitic	1.4006	X10Cr13	500-950	X12Cr13
			1.4104	X12CrMoS17	500-950	X14CrMoS17
			1.4122	X35CrMo17	500-950	X39CrMo17-1
	Vergütungsstahl, hochfest	Heat-treatment steel, high strength	1.7225	42CrMo4	950-1400	42CrMo4
			1.6580	30CrNiMo8	950-1400	30CrNiMo8
	Nitrierstahl, vergütet	Nitriding steel, heat treated	1.8504	34CrAl6	950-1400	34CrAl6
			1.2344	X40CrMoV5.1	-900	X40CrMoV5-1
Werkzeugstahl	Tool steel	1.2080	X210Cr12	950-1400	X210Cr12	
		1.2714	55NiCrMoV7	1100-1350	55NiCrMoV7	
		1.2311	40CrMnMo7	-1100	40CrMnMo7	
		1.2316	X38CrMo16	-1100	X38CrMo16	
		1.2312	40CrMnNiMoS8.6	-1150	40CrMnNiMoS8-6	
		1.2738	45CrMnNiMo8.6.4	950-1150	45CrMnNiMo8-6-4	
		1.2343	X38CrMoV5 1	950-1400	X37CrMoV5-1	
		1.2379	X155CrVMo12 1	-950	X153CrMoV12-1	
		1.2358	60CrMoV18-5	850-1000	60CrMoV18-5	
		M	Rost- und säurebe- ständiger Stahl, austenitisch	Stainless steel, austenitic	1.4301	X2CrNiMo17-12-2
1.4404	X6CrNiMoTi17-12-2				500-950	X2CrNiMo17-12-2
1.4571	X10CrNiMoTi18				500-950	X10CrNiMoTi18
Rost- und säurebe- ständiger Stahl, martensitisch aushärtbar	Stainless steel, martensitic steel		1.2709	X3NiCoMoTi18-9-5	800-1000	X3NiCoMoTi18-9-5
			1.4542	X5CrNiCuNb16-4	800-1000	X5CrNiCuNb16-4
			1.4568	X7CrNiAl17-7	800-1000	X7CrNiAl17-7
K	Grauguss	Grey cast iron	0.6025	GG25	100-400 (120-260 HB)	EN-GJL-250
	Legierter Grauguss	Alloyed grey cast iron	0.6678	GGL-NiCr35 2	150-250 (160-230 HB)	EN-GJLA-XNiCr35-2
	Sphäroguss	Nodular cast iron	0.7060 0.7070	GGG60 GGG70L	400-800 (120-310 HB)	EN-GJS-600-3 EN-GJS-700-2U
	Temperguss	Malleable cast iron	0.8155	GTS55	350-700 (150-280 HB)	EN-GJMB-550-4
S	Titan-Legierungen, mittelfest	Titanium alloys, medium strength	3.7115	TiAl5Sn2,5	-950	TiAl5Sn2-5
			3.7164	TiAl6V4	-950	TiAl6V4
	Titan-Legierungen, hochfest	Titanium alloys, high strength	3.7174	TiAl6Sn2	900-1400	TiAl6V6Sn2
	Nickelbasis-Legierungen, mittelfest	Nickel based alloys, medium strength	2.4670	NiCr12Al6MoNb	-950	NiCr12Al6MoNb
Nickelbasis-Legierungen, hochwarmfest	Heat resistant nickel based alloys, high strength	2.4668	NiCr19Fe19NbMo	900-1400	Inconel 718 NiCr19Fe19Nb5Mo3	

Die angegebenen Schnittwerte sind Startwerte und müssen auf die vorhandenen Bedingungen abgestimmt werden.
The cutting data indicated are starting values and must be adjusted to the prevailing conditions.

HM-Sorte Carbide grade	Schnittgeschwindigkeit Cutting speed v_c (m/min) Vorschub pro Zahn Feed per tooth f_z (mm/min)					
	Schruppen Roughing 			Schlichten Finishing 		
	v_c (m/min)	f_z (mm/z.)	a_p	v_c (m/min)	f_z (mm/z.)	a_p
LCP35M	150–250	0,20–0,40	4,00–6,00	180–300	0,08–0,20	0,20–2,00
LCP35M	100–250	0,20–0,40	4,00–6,00	150–250	0,08–0,15	0,20–2,00
LCP35M	150–250	0,20–0,40	4,00–6,00	180–300	0,08–0,20	0,20–2,00
LCP35M	100–200	0,20–0,40	4,00–6,00	180–300	0,08–0,15	0,20–2,00
LCP35M	100–200	0,20–0,40	4,00–6,00	150–250	0,08–0,15	0,20–2,00
LCP35M	100–200	0,20–0,40	4,00–6,00	150–250	0,08–0,15	0,20–2,00
LCP35M	100–200	0,20–0,40	4,00–6,00	150–250	0,08–0,15	0,20–2,00
LCP35M	100–200	0,15–0,35	4,00–6,00	150–250	0,10–0,20	0,20–2,00
LCMS35M	 80–120 160–220	0,10–0,25	2,00–4,00	 80–120 180–250	0,05–0,15	0,10–0,15
LCMS35M	 60–100 160–220	0,10–0,25	2,00–4,00	 60–100 180–250	0,05–0,15	0,10–0,15
LCK20M	100–300	0,10–0,35	2,00–6,00	180–350	0,05–0,20	0,20–2,00
LCK20M	100–250	0,10–0,35	2,00–6,00	150–350	0,05–0,20	0,20–2,00
LCK20M	100–350	0,10–0,35	2,00–6,00	150–380	0,10–0,20	0,20–2,00
LCMS35M	30–80 	0,05–0,15	1,00–2,50	40–80 	0,05–0,10	0,20–1,00
LCMS35M	20–60 	0,05–0,15	0,50–2,00	30–60 	0,05–0,10	0,20–1,00
LCMS35M	30–80 	0,05–0,15	1,00–2,50	40–80 	0,05–0,10	0,20–1,00
LCMS35M	30–80 	0,05–0,15	1,00–2,50	40–80 	0,05–0,10	0,20–1,00

Nassbearbeitung, auf ausreichende Emulsionszuführung achten
Wet machining, sufficient emulsion volume required

Fräsen mit Wendeschneidplatten
Milling with indexable inserts

Ausgelegt für Hochvorschubfräsanwendungen bis 1,0 mm ($a_{p \max}$)
Designed for high feed milling applications up to 1.0 mm ($a_{p \max}$)

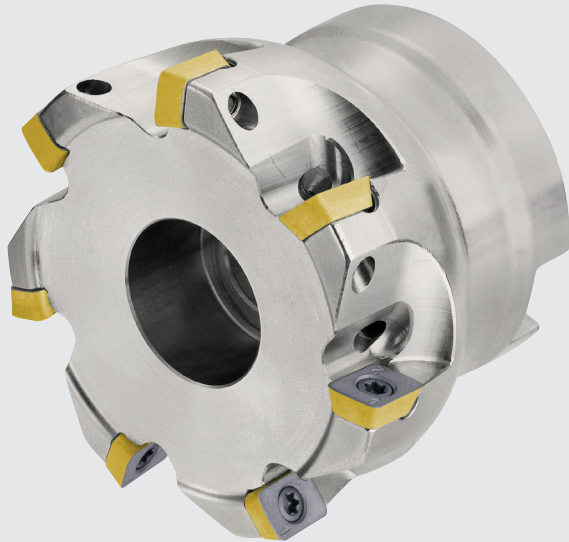

Einheitlich kleine Wendschneidplatte für den gesamten Durchmesserbereich
Unified small inserts for the entire diameter range

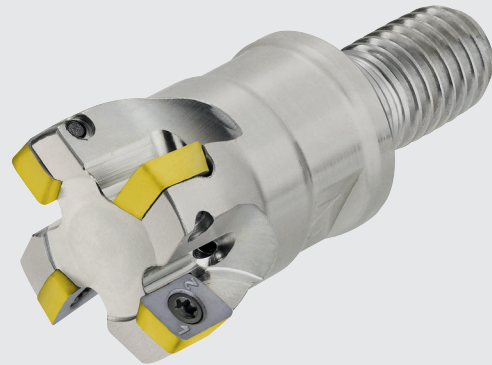

Unterschiedliche Topografien und Schneidstoffe für die Bearbeitung von Stahl, rostfreiem Stahl, Guss und gehärtetem Stahl
Different topographies and cutting grades for the machining of steel, stainless steel, cast iron and hardened steel

Positive Schnittgeometrie zum Hochvorschubfräsen auch auf Leistungsschwachen Bearbeitungszentren
Positive cutting geometry for high feed operations even on less powerful machining centers

Der Wendeplattenfräser MultiEdge 2Feed mini von LMT Fette findet seine Anwendung beim Schruppen kleiner und mittlerer Bauteile. Das Trägerprogramm des MultiEdge 2Feed mini ist in den Durchmessern von 16–42 mm als Aufschraubfräser mit 2–6 Schneiden, sowie in den Durchmessern von 40–80 mm als Aufsteckfräser mit bis zu 9 Schneiden verfügbar.

The indexable insert cutters MultiEdge 2Feed mini LMT Fette is designed for roughing applications of small and medium work pieces. The cutter bodies for the MultiEdge 2Feed mini are available in diameters 16–42 mm for screw-on-type with 2–6 teeth, as well as in diameters of 40–80 mm for arbor type with up to 9 teeth.

MultiEdge 2Feed mini
Hochvorschubfräser – Aufschraubausführung
High feed milling cutter – screw-on type

Katalog-Nr. Cat.-No.										EHP IK		
d ₁	d _i	l ₃	d ₃	d ₅	d ₂	z	a _{p max}	Ident No.	LMT-Code			
16	7	28	M8	13	8,5	2	1	7139270	EHP X09.016TR028-I	XDMW 0903... XDMT 0903...	2127640	1048326 T8
16	7	28	M8	13	8,5	3	1	7171528	EHP X09.016TR028-IF			
20	11	30	M10	18	10,5	3	1	7139271	EHP X09.020TS030-I		1044972	
20	11	30	M10	18	10,5	4	1	7185986	EHP X09.020TS030-IF			
25	16	33	M12	21	12,5	4	1	7139272	EHP X09.025TF033-I			
32	23	43	M16	29	17	5	1	7139273	EHP X09.032TH043-I			
35	26	43	M16	29	17	5	1	7139274	EHP X09.035TH043-I			
42	33	43	M16	29	17	6	1	7139275	EHP X09.042TH043-I			

MultiEdge 2Feed mini
Hochvorschubfräser – Aufsteckausführung
High feed milling cutter – arbor type

Katalog-Nr. Cat.-No.										FHP IK		
d ₁	d _i	h	d ₅	d ₂	z	a _{p max}	Ident No.	LMT-Code				
35	26	40	32	16	5	1	7143287	FHP X09.035AN-I	XDMW 0903... XDMT 0903...	1044972	1048326 T8	
35	26	40	32	16	6	1	7151696	FHP X09.035AN-IF				
40	31	40	32	16	6	1	7139276	FHP X09.040AN-I				
42	33	40	32	16	6	1	7139277	FHP X09.042AN-I				
50	41	40	40	22	7	1	7139278	FHP X09.050AN-I				
52	43	40	40	22	7	1	7139279	FHP X09.052AN-I				
63	54	50	50	27	8	1	7139280	FHP X09.063AN-I				
66	57	50	50	27	8	1	7139281	FHP X09.066AN-I				
80	71	50	50	27	9	1	7139282	FHP X09.080AN-I				

Schnittwertempfehlungen ab Seite 278
 Cutting data recommendations starting page 278

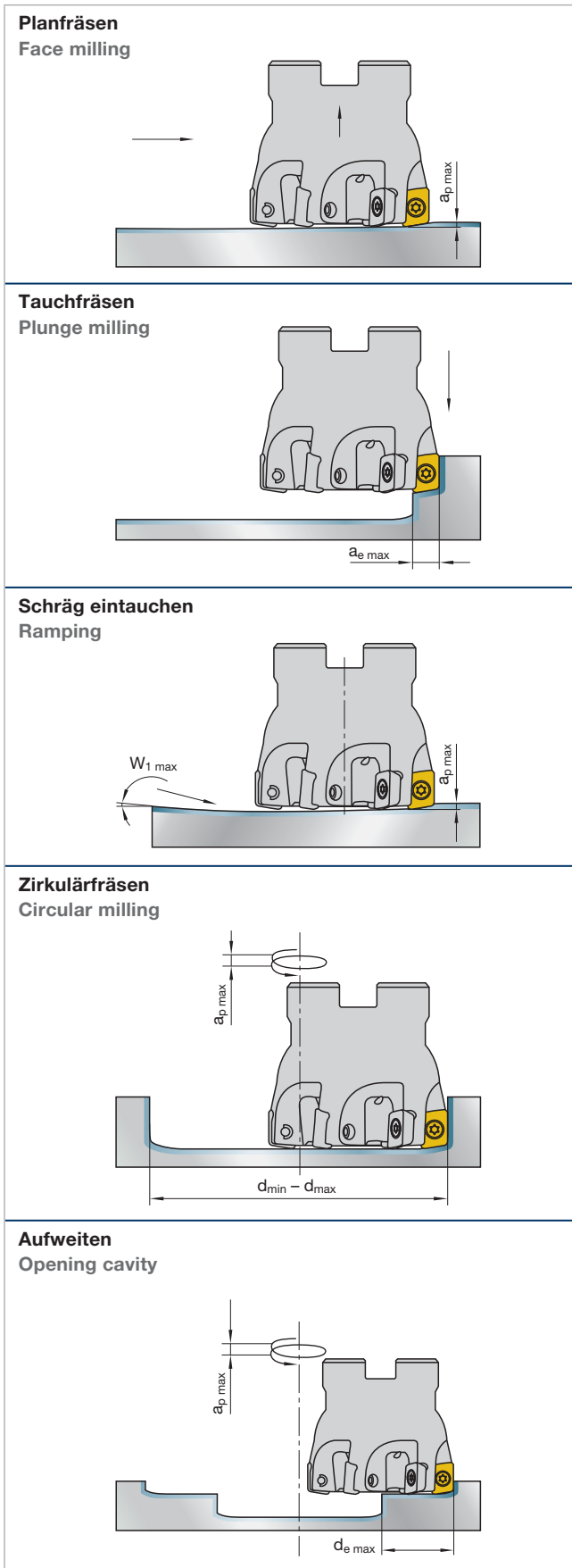

Werkzeug Tool	E(F)HP X09.
Wendeplatten Insert	XDMW 090308SR XDMW 090316SR XDMT 090308ER XDMT 090316ER
$a_{p \max}$ (mm)	1
$a_{e \max}$ (mm)	5
T_{\max} (mm)	0,5
d_1 (mm)	$W_{1 \max}$ (°)
16	4
20	4
25	4
32	2,5
35	2
40/42	1,8
50/52	1,5
63/66	1
80	0,8
d_1 (mm)	$d_{\min} - d_{\max}$ (mm)
16	22- 31
20	30- 39
25	40- 49
32	54- 62
35	60- 68
40	70- 78
42	74- 82
50	90- 98
52	94-102
63	116-124
66	122-130
80	150-158
d_1 (mm)	$d_{e \max}$ (mm)
16	11
20	15
25	20
32	27
35	30
40	35
42	37
50	45
52	47
63	58
66	61
80	75

T_{\max} : axiale Bohrtiefe axial drilling depth

MultiEdge 2Feed mini
Schnittwertempfehlungen
Cutting data recommendations

	Werkstoff	Material	Werkstoff-Nr. Material No.	DIN Bezeichnung Alt DIN Description Old	R_m/UTS (N/mm²)	DIN Bezeichnung Neu DIN Description New
P	Unlegierter Baustahl + Automatenstahl	Plain carbon steel + free cutting steel	1.0570	St52-3	-700	S355J2G3
			1.1730	C45	-800	C45U
			1.0715	9SMn28	-700	11SMn30
			1.1191	Ck45	500-950	C45E
			1.7219	26CrMo4	500-950	26CrMo4-2
	Vergütungsstahl, mittelfest	Heat-treatment steel, medium strength	1.7225	42CrMo4	500-950	42CrMo4
			1.8159	51CrV4	500-950	51CrV4
	Stahlguss	Cast steel	1.0416	GS40	-950	GS40
	Einsatzstahl	Case hardening steel	1.7131	16MnCr5	-950	16MnCr5
	Rost- und säurebe- ständiger Stahl, ferritisch, martensitisch	Stainless steel, ferritic, martensitic	1.4006	X10Cr13	500-950	X12Cr13
			1.4104	X12CrMoS17	500-950	X14CrMoS17
			1.4122	X35CrMo17	500-950	X39CrMo17-1
	Vergütungsstahl, hochfest	Heat-treatment steel, high strength	1.7225	42CrMo4	950-1400	42CrMo4
			1.6580	30CrNiMo8	950-1400	30CrNiMo8
	Nitrierstahl, vergütet	Nitriding steel, heat treated	1.8504	34CrAl6	950-1400	34CrAl6
			1.2344	X40CrMoV5.1	-900	X40CrMoV5-1
	Werkzeugstahl	Tool steel	1.2738	45CrMnNiMo8.6.4	950-1150	45CrMnNiMo8-6-4
1.2379			X155CrVMo12 1	-950	X153CrMoV12-1	
1.2080			X210Cr12	950-1400	X210Cr12	
1.2311			40CrMnMo7	-1100	40CrMnMo7	
1.2312			40CrMnNiMoS8.6	-1150	40CrMnNiMoS8-6	
1.2343			X38CrMoV5 1	950-1400	X37CrMoV5-1	
1.2358			60CrMoV18-5	850-1000	60CrMoV18-5	
1.2714			55NiCrMoV7	1100-1350	55NiCrMoV7	
M	Rost- und säurebe- ständiger Stahl, austenitisch	Stainless steel, austenitic	1.4301	X2CrNiMo17-12-2	500-950	X5CrNiMo18-10
			1.4404	X6CrNiMoTi17-12-2	500-950	X2CrNiMo17-12-2
			1.4571	X10CrNiMoTi18	500-950	X10CrNiMoTi18
	Rost- und säurebe- ständiger Stahl, martensitisch aushärtbar	Stainless steel, martensitic steel	1.2709	X3NiCoMoTi18-9-5	800-1000	X3NiCoMoTi18-9-5
			1.4542	X5CrNiCuNb16-4	800-1000	X5CrNiCuNb16-4
1.4568	X7CrNiAl17-7	800-1000	X7CrNiAl17-7			
K	Grauguss	Grey cast iron	0.6025	GG25	100-400 (120-260 HB)	EN-GJL-250
	Legierter Grauguss	Alloyed grey cast iron	0.6678	GGL-NiCr35 2	150-250 (160-230 HB)	EN-GJLA-XNiCr35-2
	Sphäroguss	Nodular cast iron	0.7060	GGG60	400-800	EN-GJS-600-3
			0.7070	GGG70L	(120-310 HB)	EN-GJS-700-2U
	Temperguss	Malleable cast iron	0.8155	GTS55	350-700 (150-280 HB)	EN-GJMB-550-4
H	Hartguss	Chilled cast iron		Ni-hard, Ampco	300-600 HB	Ni-hard, Ampco
	Gehärteter Stahl	Hardened steel		Sleipner, Toolox	45-52 HRC	Sleipner, Toolox
				Dievar	53-59 HRC	Dievar
				Vandis, Sverker	60-65 HRC	Vandis, Sverker

Die angegebenen Schnittwerte sind Startwerte und müssen auf die vorhandenen Bedingungen abgestimmt werden.
 The cutting data indicated are starting values and must be adjusted to the prevailing conditions.

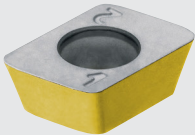

XDMW

Merkmale:

- Stabile Wendeschneidplatten-Geometrie für die Zerspanung hochfester Vergütungs- und Werkzeugstähle
- Negative Schutzfase mit Schneidkantenverrundung

Features:

- Stable indexable insert geometry for cutting high-strength tempering and tool steels
- Negative protective chamfer with rounded cutting edge

**Spanformstufen
Chip-breaker**

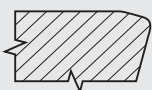

-SR

Empfohlene max. Zahnvorschübe f_z in mm bei $a_e = 0,75 \times d_1$ und $a_p = 0,6$ mm
 Recommended max. feed per tooth f_z with $a_e = 0.75 \times d_1$ and $a_p = 0.6$ mm
 (d_1 = Fräserdurchmesser Cutter diameter)

Schnittgeschwindigkeit Cutting speed v_c (m/min)
 Vorschub pro Zahn Feed per tooth f_z (mm/min)

LCP40M			LCM45M		LCKP10M LCHK15M		
v_c	XDMW... f_z	XDMT... f_z	v_c	XDMW... f_z	v_c	XDMW... f_z	XDMT... f_z
200–260	1,70	1,40			260–270	1,50	1,30
160–210	1,50	1,30			180–220	1,40	1,20
150–180	1,40	1,20			160–190	1,30–1,40	1,10–1,20
150–180	1,40				160–190	1,30–1,40	1,10–1,20
160–210	1,50	1,30			160–210	1,40	1,20
160–210	1,20–1,40	1,00–1,20			160–210	1,20–1,40	1,00–1,20
120–140	1,20	1,00			180	1,00	0,80
160–210	1,00–1,40	0,80–1,20			180–220	1,00–1,40	0,80–1,20
160–210	1,00–1,40	0,80–1,20			180–220	1,00–1,40	0,80–1,20
140–180	1,00–1,40	0,80–1,20			210–240	1,00–1,40	0,80–1,20
140–160		0,60–0,80	200–240	0,60–0,80			
120–140		0,60–0,80	200–240	0,60–0,80			
					180–200	0,80–1,20	
					200–240	0,80–1,20	
					60–90	0,70–1,00	
					80	0,70	
					65	0,40	
					60	0,30	

Fräsen mit Wertschneidplatten
Milling with indexable inserts

Trockenbearbeitung, Pressluftkühlung ist vorteilhaft
 Dry machining, air-blast cooling is advantageous



XDMT

Merkmale:

- Weichschneidende Wertschneidplatten-Geometrie zur Reduzierung der Zerspankräfte
- Einsatz bei labilen Aufspannungen
- Besonders geeignet für Werkzeugmaschinen mit geringerer Antriebsleistung

Features:

- Soft-cutting indexable insert geometry to reduce cutting forces
- Use for unstable setups
- Particularly useful for machine tools with low power capacities

**Spanformstufen
Chip-breaker**

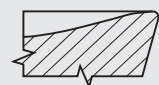

-ER

MultiEdge 3Feed
Hochvorschubfräser – Aufschraubausführung
High feed milling cutter – screw-on type

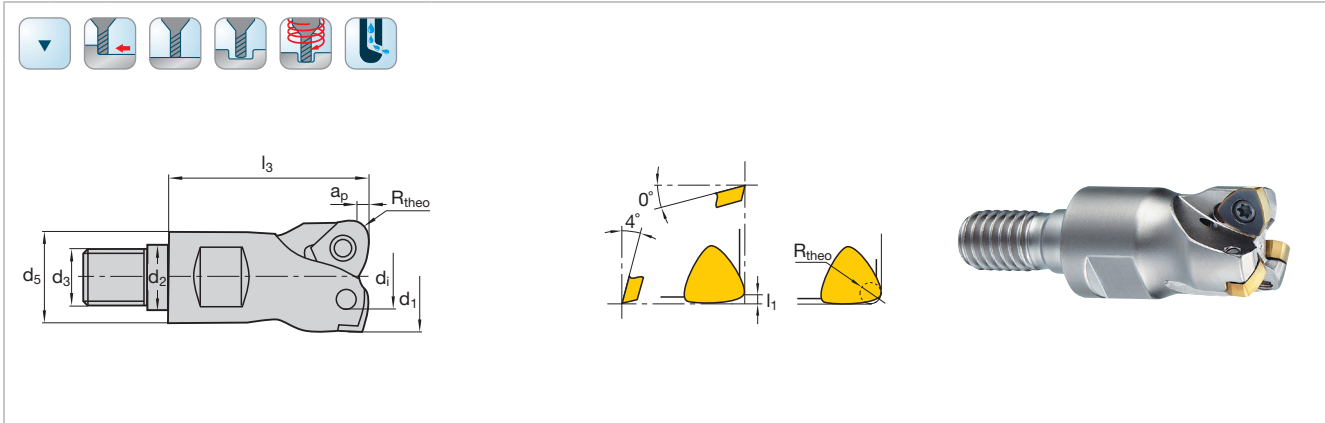

Katalog-Nr. Cat.-No.										ECP IK			
d ₁	d _i	l ₃	d ₃	d ₅	d ₂	z	a _{p,max}	R _{theo}	Ident No.	LMT-Code			
16	4,8	28	M8	13	8,5	2	1	1,5	1025001	ECP X07.16TR028-I	XP.. 070308..	1044972	1048326 T8
20	9	30	M10	18	10,5	3	1	1,5	1025005	ECP X07.20TE030-I			
25	14	33	M12	21	12,5	3	1	1,5	1025006	ECP X07.25TF033-I			
25	14	33	M12	21	12,5	4	1	1,5	1025007	ECP X07.25TF033-IF			

Fräser auch verfügbar in Zoll-Abmessungen
 Cutters also available in inch dimensions

MultiEdge 3Feed
Hochvorschubfräser – Schaftausführung
High feed milling cutter – shank type

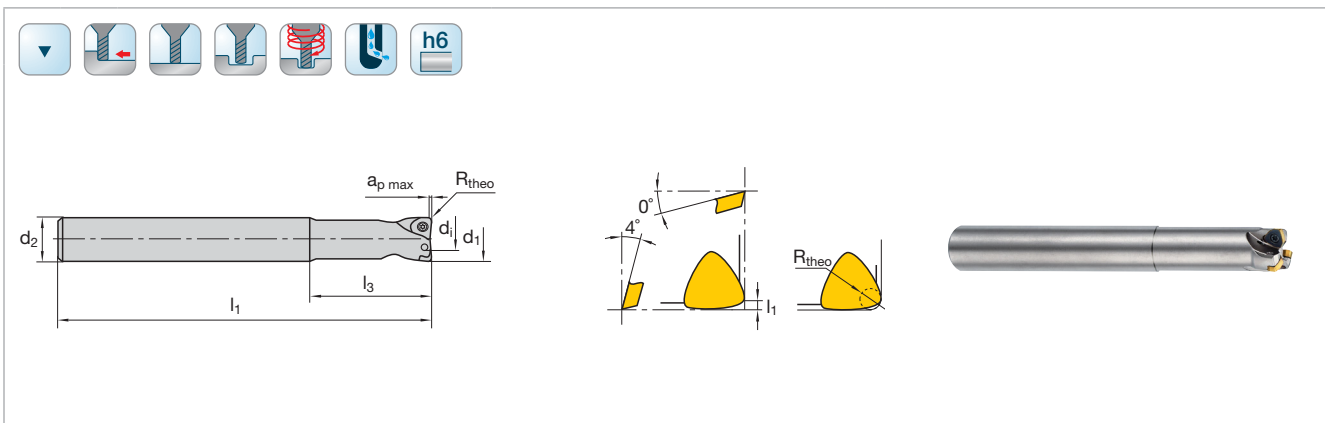

Katalog-Nr. Cat.-No.										ECP IK			
d ₁	d _i	l ₃	l ₁	d ₂	z	a _{p,max}	R _{theo}	Ident No.	ISO-Code				
16	4,8	45	160	16	2	1	1,5	1025025	ECP X07.16AN160-I	XP.. 070308..	1044972	1048326 T8	
20	9	60	175	20	3	1	1,5	1025026	ECP X07.20AN175-I				
25	14	75	190	25	3	1	1,5	1025027	ECP X07.25AN190-I				
25	14	75	190	25	4	1	1,5	1025028	ECP X07.25AN190-IF				

Fräser auch verfügbar in Zoll-Abmessungen
 Cutters also available in inch dimensions

Schnittwertempfehlungen ab Seite 282
 Cutting data recommendations starting page 282

							Schneidstoffsorten Cutting materials Ident No.											Für Fräser For cutter Cat-No.								
N = Anzahl der Schneidkanten N = Number of cutting edges	ISO-Code	l	d	s	d ₁	r	LCP40M	LCPM40M	LCPK30M	LCP25M	LCPK10M	LCM45M	LCM44M	LCKP30M	LCKP10M	LCK20M	LCK10M	LCN10M	LWN10M	LCHP15M	LCH50M					
 N = 3	XPMW 070308 SR	-	6,79	2,78	2,8	0,8	7160173					7160174			7160175									ECP IK		
	XPHW 070308 SR	-	6,79	2,78	2,8	0,8		1058192			1058193															
 N = 3	XPMT 070308 ER	-	6,79	2,78	2,8	0,8	7160176					7160177			7160178										ECP IK	
							■	■			■	□			□										P	
							□	□					■													M
											□				■											K
																										N
													□													S
																										H

■ = Hauptanwendung First choice
 □ = Nebenanwendung Alternative

Sortenbeschreibung/-bezeichnung und ISO-Code ab Seite 424/477
 Description/Designation of grades and ISO-Code starting page 424/477

Fräser mit Wendeschneidplatten
Milling with indexable inserts

MultiEdge 3Feed
Schnittwertempfehlungen
Cutting data recommendations

	Werkstoff	Material	Werkstoff-Nr. Material No.	DIN Bezeichnung Alt DIN Description Old	R_m/UTS (N/mm²)	DIN Bezeichnung Neu DIN Description New
P	Unlegierter Baustahl + Automatenstahl	Plain carbon steel + free cutting steel	1.0570	St52-3	-700	S355J2G3
			1.1730	C45	-800	C45U
			1.0715	9SMn28	-700	11SMn30
			1.1191	Ck45	500-950	C45E
			1.7219	26CrMo4	500-950	26CrMo4-2
	Vergütungsstahl, mittelfest	Heat-treatment steel, medium strength	1.7225	42CrMo4	500-950	42CrMo4
			1.8159	51CrV4	500-950	51CrV4
	Stahlguss	Cast steel	1.0416	GS40	-950	GS40
	Einsatzstahl	Case hardening steel	1.7131	16MnCr5	-950	16MnCr5
	Rost- und säurebe- ständiger Stahl, ferritisch, martensitisch	Stainless steel, ferritic, martensitic	1.4006	X10Cr13	500-950	X12Cr13
			1.4104	X12CrMoS17	500-950	X14CrMoS17
			1.4122	X35CrMo17	500-950	X39CrMo17-1
	Vergütungsstahl, hochfest	Heat-treatment steel, high strength	1.7225	42CrMo4	950-1400	42CrMo4
			1.6580	30CrNiMo8	950-1400	30CrNiMo8
	Nitrierstahl, vergütet	Nitriding steel, heat treated	1.8504	34CrAl6	950-1400	34CrAl6
			1.2344	X40CrMoV5.1	-900	X40CrMoV5-1
	Werkzeugstahl	Tool steel	1.2358	60CrMoV18-5	850-1000	60CrMoV18-5
1.2714			55NiCrMoV7	1100-1350	55NiCrMoV7	
1.2316			X38CrMo16	-1100	X38CrMo16	
1.2343			X38CrMoV5 1	950-1400	X37CrMoV5-1	
1.2311			40CrMnMo7	-1100	40CrMnMo7	
1.2312			40CrMnNiMoS8.6	-1150	40CrMnNiMoS8-6	
1.2738			45CrMnNiMo8.6.4	950-1150	45CrMnNiMo8-6-4	
1.2379			X155CrVMo12 1	-950	X153CrMoV12-1	
1.2080			X210Cr12	950-1400	X210Cr12	
M	Rost- und säurebe- ständiger Stahl, austenitisch	Stainless steel, austenitic	1.4301	X2CrNiMo17-12-2	500-950	X5CrNiMo18-10
			1.4404	X6CrNiMoTi17-12-2	500-950	X2CrNiMo17-12-2
			1.4571	X10CrNiMoTi18	500-950	X10CrNiMoTi18
	Rost- und säurebe- ständiger Stahl, martensitisch aushärtbar	Stainless steel, martensitic steel	1.2709	X3NiCoMoTi18-9-5	800-1000	X3NiCoMoTi18-9-5
			1.4542	X5CrNiCuNb16-4	800-1000	X5CrNiCuNb16-4
1.4568	X7CrNiAl17-7	800-1000	X7CrNiAl17-7			
K	Grauguss	Grey cast iron	0.6025	GG25	100-400 (120-260 HB)	EN-GJL-250
			0.6678	GGL-NiCr35 2	150-250 (160-230 HB)	EN-GJLA-XNiCr35-2
	Sphäroguss	Nodular cast iron	0.7060	GGG60	400-800	EN-GJS-600-3
			0.7070	GGG70L	(120-310 HB)	EN-GJS-700-2U
	Temperguss	Malleable cast iron	0.8155	GTS55	350-700 (150-280 HB)	EN-GJMB-550-4

Die angegebenen Schnittwerte sind Startwerte und müssen auf die vorhandenen Bedingungen abgestimmt werden.
The cutting data indicated are starting values and must be adjusted to the prevailing conditions.

 **Trockenbearbeitung, Pressluftkühlung ist vorteilhaft**
Dry machining, air-blast cooling is advantageous

Vorschub pro Zahn Feed per tooth f_z (mm/z.)			
Schnittgeschwindigkeit Cutting speed v_c (m/min)			
LCPM40M/LCP40M/LCM45M		LCKP10M	
v_c	f_z	v_c	f_z
200–260	1,70	260–270	1,50
160–200	1,50	180–220	1,40
150–180	1,40	160–190	1,30–1,40
150–180	1,40	160–190	1,30–1,40
140–180	1,50	150–190	1,40
140–180	1,20–1,40	150–190	1,20–1,40
120–140	1,20	180	1,00
140–190	1,00–1,40	210–240	1,00–1,40
220–260	1,00		
220–260	1,00		
		200–260	1,70
		160–200	1,40
		200–240	1,00–1,20
		170–210	1,00–1,20

XPHW

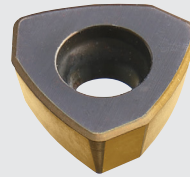

Spanformstufen Chip-breakers:

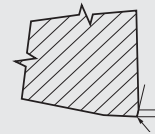

-SN

Merkmale:

- Hohe Zähnezahlen auch bei kleinen Durchmessern
- Stabile Wendeschneidplatten-Geometrie für ein breites Anwendungsspektrum
- Negative Schutzfase mit Schneidkantenverrundung

Features:

- High number of teeth even for small diameters
- Robust indexable insert geometry for a broad area of application
- Negative protective chamfer with rounded cutting edge

XPMT

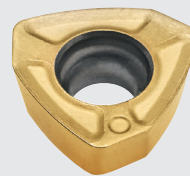

Spanformstufen Chip-breakers:



-SN

Merkmale:

- Weichschneidende Wendeschneidplatten-Geometrie zur Reduzierung der Zerspankräfte
- Einsatz bei labilen Aufspannungen
- Besonders geeignet für Werkzeugmaschinen mit geringerer Antriebsleistung

Features:

- Soft-cutting indexable insert geometry to reduce cutting forces
- Use for unstable setups
- Particularly useful for machine tools with low power capacities

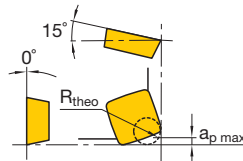
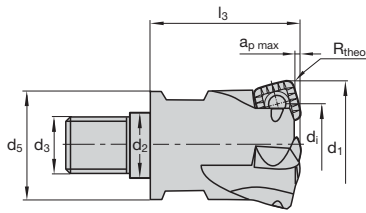

Katalog-Nr. Cat.-No.										ECP			
d ₁	d _i	l ₃	d ₃	d ₅	d ₂	z	a _{p max}	R _{theo}	Ident No.	LMT-Code			
ECP V07 IK													
20	6,9	30	M10	18	10,5	2	1	1,5	7028485	ECP V07.020TS030-I	XCN.. 070308..	9199156	1048326 T8
25	12	33	M12	21	12,5	3	1	1,5	7028486	ECP V07.025TF033-I			
32	19	43	M16	29	17	3	1	1,5	7028487	ECP V07.032TH043-I			
32	19	43	M16	29	17	4	1	1,5	7028488	ECP V07.032TH043-IF			
35	22	43	M16	29	17	5	1	1,5	7028489	ECP V07.035TH043-I			
ECP V09 IK													
32	17	43	M16	29	17	3	1,2	2,5	7028490	ECP V09.032TH043-I	XCN.. 09T312..	1045105	1048335 T15
32	17	43	M16	29	17	4	1,2	2,5	7028491	ECP V09.032TH043-IF			
35	20	43	M16	29	17	4	1,2	2,5	7028492	ECP V09.035TH043-I			
42	27	43	M16	29	17	4	1,2	2,5	7028493	ECP V09.042TH043-IW			
42	27	43	M16	29	17	5	1,2	2,5	7028494	ECP V09.042TH043-I			

Fräser auch verfügbar in Zoll-Abmessungen
 Cutters also available in inch dimensions

Schnittwertempfehlungen ab Seite 290
 Cutting data recommendations starting page 290

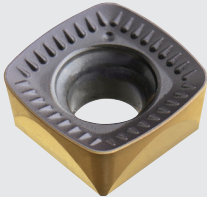
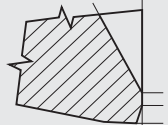
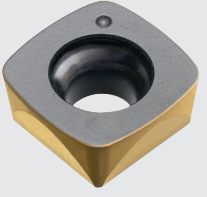
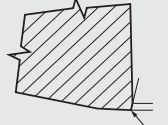
 XCNT	<p>Merkmale:</p> <ul style="list-style-type: none"> ■ Universelle Wendschneidplatten-Geometrie für ein breites Anwendungsfeld ■ Breite negative Schutzfase für erhöhte Schneidkantenstabilität ■ Optimal für den Einsatz auf leistungsstarken Maschinen 	<p>Features:</p> <ul style="list-style-type: none"> ■ Universal indexable insert geometry for a broad area of application ■ Wide negative protective chamfer for increased cutting edge stability ■ Ideal for use on powerful machines 	<p>Spanformstufen Chip-breakers:</p>  -SN-TR
 XCNW	<p>Merkmale:</p> <ul style="list-style-type: none"> ■ Stabile Wendschneidplatten-Geometrie für die Zerspanung hochfester Vergütungs- und Werkzeugstähle ■ Negative Schutzfase mit Schneidkantenverrundung 	<p>Features:</p> <ul style="list-style-type: none"> ■ Robust indexable insert geometry for cutting high-strength tempering and tool steels ■ Negative protective chamfer with rounded cutting edge 	<p>Spanformstufen Chip-breakers:</p>  -SN

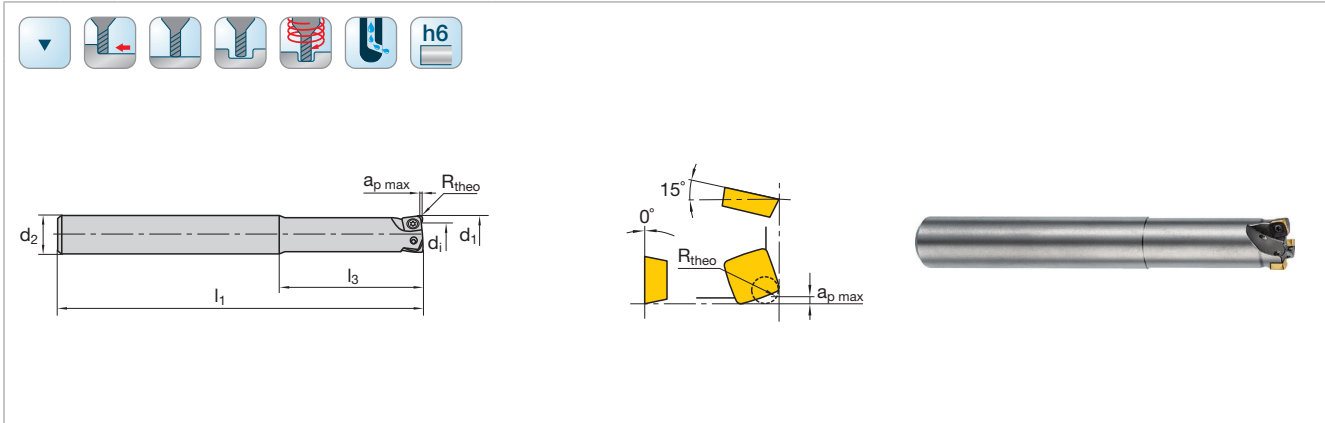

Katalog-Nr. Cat.-No.										ECP			
d ₁	d _i	l ₃	l ₁	d ₂	z	a _{p max}	R _{theo}	Ident No.	LMT-Code				
ECP V07 IK													
20	6,9	60	175	20	2	1	1,5	7028512	ECP V07.020AN175-I	XCN.. 070308..	9199156	1048326 T8	
25	12	75	190	25	3	1	1,5	7028513	ECP V07.025AN190-I				
32	19	80	210	32	3	1	1,5	7028514	ECP V07.032AN210-I				
32	19	80	210	32	4	1	1,5	7028515	ECP V07.032AN210-IF				
ECP V09 IK													
32	17	80	210	32	3	1,2	2,5	7028516	ECP V09.032AN210-I	XCN.. 09T312..	1045105	1048335 T15	
32	17	80	210	32	4	1,2	2,5	7028517	ECP V09.032AN210-IF				

Fräser auch verfügbar in Zoll-Abmessungen
 Cutters also available in inch dimensions

Schnittwertempfehlungen ab Seite 290
 Cutting data recommendations starting page 290

Fräser mit Wendeschneidplatten
Milling with indexable inserts

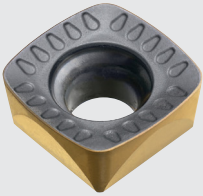

XCNT

Merkmale:

- Weichschneidende Wendeschneidplatten-Geometrie zur Reduzierung der Zerspankräfte
- Einsatz rostfreier Stähle und langspanender Werkstoffe
- Besonders geeignet für Werkzeugmaschinen mit geringerer Antriebsleistung

Features:

- Soft-cutting indexable insert geometry to reduce cutting forces
- Use of stainless steels and long-chipping materials
- Particularly useful for machine tools with low power capacities

**Spanformstufen
Chip-breakers:**

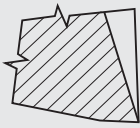

-EN (-TR)

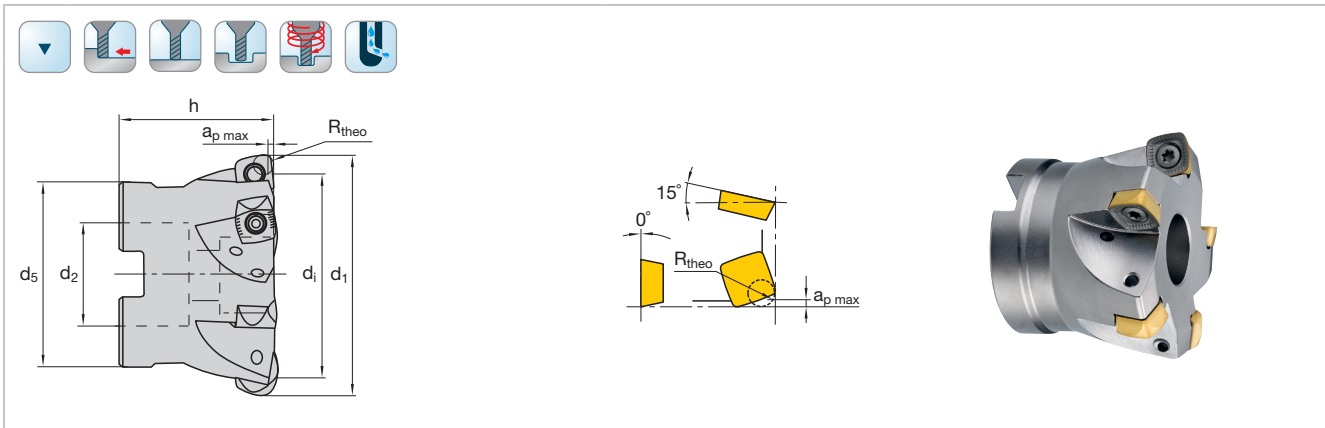

Katalog-Nr. Cat.-No.										FCP					
d ₁	d _i	h	d ₅	d ₂	z	a _{p max}	R _{theo}	Ident No.	LMT-Code						
FCP V09 IK															
42	27	40	32	16	3	1,2	2,5	7028495	FCP V09.042AN-IX				XCNT.. 09T312..	1045114	1048335 T15
42	27	40	32	16	4	1,2	2,5	7028496	FCP V09.042AN-IW						
42	27	40	32	16	5	1,2	2,5	7028497	FCP V09.042AN-I						
52	37	40	40	22	4	1,2	2,5	7028498	FCP V09.052AN-IX						
52	37	40	40	22	5	1,2	2,5	7028499	FCP V09.052AN-IW						
52	37	40	40	22	6	1,2	2,5	7028500	FCP V09.052AN-I						
FCP V12 IK															
42	23	40	32	16	3	1,5	3,5	7028501	FCP V12.042AN-IW				XCNT.. 120520..	1045123	1048344 T20
42	23	40	32	16	4	1,5	3,5	7028502	FCP V12.042AN-I						
52	33,1	40	40	22	4	1,5	3,5	7028503	FCP V12.052AN-IW						
52	33,1	40	40	22	5	1,5	3,5	7028504	FCP V12.052AN-I						
66	47,1	50	50	27	5	1,5	3,5	7028505	FCP V12.066AN-IX						
66	47,1	50	50	27	6	1,5	3,5	7028506	FCP V12.066AN-IW						
66	47,1	50	50	27	7	1,5	3,5	7028507	FCP V12.066AN-I						
80	61,2	50	60	27	6	1,5	3,5	7028508	FCP V12.080AN-IW						
80	61,2	50	60	27	8	1,5	3,5	7028509	FCP V12.080AN-I						
100	81,2	50	65	32	7	1,5	3,5	7028510	FCP V12.100AN-IW						
100	81,2	50	65	32	10	1,5	3,5	7028511	FCP V12.100AN-I						

Fräser auch verfügbar in Zoll-Abmessungen
 Cutters also available in inch dimensions

Schnittwertempfehlungen ab Seite 290
 Cutting data recommendations starting page 290

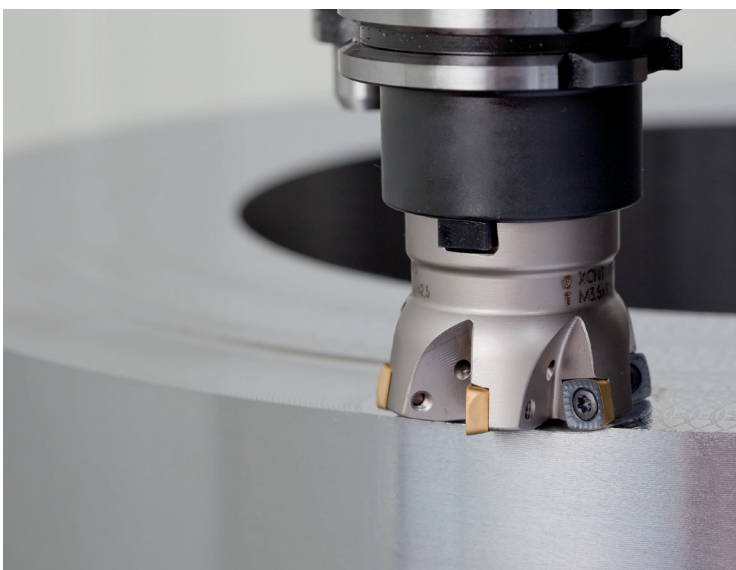

Planfräsen, Maschinenbauteil, Flansch
Face milling, machine component, flange

Werkzeug Tool:
 FCP V09.052 AN-I, d₁ = 52 mm, z = 6

Werkstoff Material:
 Nichtrostender austenitischer Stahl 1.4301
 Stainless steel, austenitic

Wendepatte Insert:
 XCNT 09T312 EN-TR | LC280QN

Schnittwerte Cutting data:
 v_c = 240 m/min
 n = 1470 min⁻¹
 f_z = 1,2 mm
 v_f = 10600 mm/min
 a_e = 35 mm
 a_p = 1,0 mm

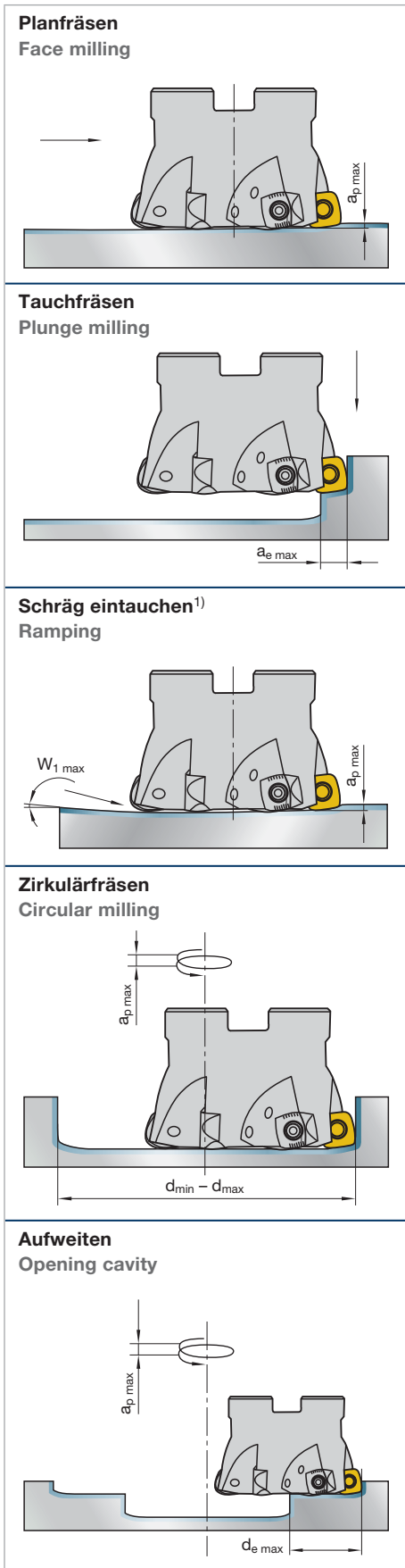

Werkzeug Tool	ECP X07.	ECP V07.	E(F)CP V09.	E(F)CP V12.
Wendeplatten Insert	XPNW070308	XCN_070308	XCN_09T312	XCN_120420
$a_{p \max}$ (mm)	1	0,8	1	1,5
$a_{e \max}$ (mm)	6	7	8	10
T_{\max} (mm)	0,5	0,8	1	1,5
$a_{e \max}$ (mm)	2,5	2	2,5	3
d_1 (mm)	$W_{1 \max}$ (°)			
16	3,5			
20	1,8	7,5		
25	1,2	4		
32		2,5	4	
35		2	3	
42			2	4,5
52			1,5	3
66				2
80				1,5
100				1
d_1 (mm)	$d_{\min} - d_{\max}$ (mm)			
16	20-31			
20	28-39	26-39		
25	38-49	36-49		
32		50-62	48- 62	
35		56-68	54- 68	
42			68- 82	64- 82
52			88-102	84-102
66				112-130
80				140-158
100				180-198
d_1 (mm)	$d_{e \max}$ (mm)			
16	10			
20	14	13		
25	19	18		
32		25	24	
35		28	27	
42			34	32
52			44	42
66				56
80				70
100				90

T_{\max} : axiale Bohrtiefe axial drilling depth

¹⁾ nicht für Double4Feed Hochvorschub-Planfräsköpfe
not for Double4Feed High feed milling cutters

Fräsen mit Wendeschneidplatten
Milling with indexable inserts

MultiEdge 4Feed
Schnittwertempfehlungen
Cutting data recommendations

				DIN Bezeichnung Alt DIN Description Old	R _m /UTS (N/mm ²)	DIN Bezeichnung Neu DIN Description New				
	Werkstoff	Material	Werkstoff-Nr. Material No.							
P	Unlegierter Baustahl + Automatenstahl	Plain carbon steel + free cutting steel	1.0570	St52-3	-700	S355J2G3				
			1.1730	C45	-800	C45U				
			1.0715	9SMn28	-700	11SMn30				
			1.1191 1.7219	Ck45 26CrMo4	500-950	C45E 26CrMo4-2				
	Vergütungsstahl, mittelfest	Heat-treatment steel, medium strength	1.7225	42CrMo4	500-950	42CrMo4				
	Stahlguss	Cast steel	1.8159	51CrV4		51CrV4				
	Einsatzstahl	Case hardening steel	1.0416	GS40	-950	GS40				
	Rost- und säurebe- ständiger Stahl, ferritisch, martensitisch	Stainless steel, ferritic, martensitic	1.7131	16MnCr5	-950	16MnCr5				
			1.4006	X10Cr13	500-950	X12Cr13				
			1.4104 1.4122	X12CrMoS17 X35CrMo17		X14CrMoS17 X39CrMo17-1				
	Vergütungsstahl, hochfest	Heat-treatment steel, high strength	1.7225	42CrMo4	950-1400	42CrMo4				
	Nitrierstahl, vergütet	Nitriding steel, heat treated	1.6580	30CrNiMo8		30CrNiMo8				
			1.2344	X40CrMoV5.1	-900	X40CrMoV5-1				
	Werkzeugstahl	Tool steel	1.8504	34CrAl6	950-1400	34CrAl6				
			1.2343	X38CrMoV5 1	950-1400	X37CrMoV5-1				
			1.2379	X155CrVMo12 1	-950	X153CrMoV12-1				
			1.2080	X210Cr12	950-1400	X210Cr12				
1.2311			40CrMnMo7	-1100	40CrMnMo7					
1.2312			40CrMnNiMoS8.6	-1150	40CrMnNiMoS8-6					
1.2738			45CrMnNiMo8.6.4	950-1150	45CrMnNiMo8-6-4					
1.2358			60CrMoV18-5	850-1000	60CrMoV18-5					
1.2714 1.2316			55NiCrMoV7 X38CrMo16	1100-1350 -1100	55NiCrMoV7 X38CrMo16					
M	Rost- und säurebe- ständiger Stahl, austenitisch	Stainless steel, austenitic	1.4404	X6CrNiMoTi17-12-2	500-950	X2CrNiMo17-12-2				
			1.4571	X10CrNiMoTi18		X10CrNiMoTi18				
			1.4301	X2CrNiMo17-12-2		X5CrNiMo18-10				
Rost- und säurebe- ständiger Stahl, martensitisch aushärtbar	Stainless steel, martensitic steel	1.2709	X3NiCoMoTi18-9-5	800-1000	X3NiCoMoTi18-9-5					
		1.4542	X5CrNiCuNb16-4		X5CrNiCuNb16-4					
		1.4568	X7CrNiAl17-7		X7CrNiAl17-7					
K	Grauguss	Grey cast iron	0.6025	GG25	100-400 (120-260 HB)	EN-GJ1-250				
			Legierter Grauguss	Alloyed grey cast iron	0.6678	GGL-NiCr35 2	150-250 (160-230 HB)	EN-GJLA-XNiCr35-2		
					Sphäroguss	Nodular cast iron	0.7060	GGG60	400-800 (120-310 HB)	EN-GJS-600-3
							0.7070	GGG70L		EN-GJS-700-2U
Temperguss	Malleable cast iron	0.8155	GTS55	350-700 (150-280 HB)	EN-GJMB-550-4					
N	Aluminium-Legierungen, kurzspanend	Aluminium alloys, short chipping	3.2581	G-AlSi12	-400	G-IGKAISi12				
	Aluminium-Legierungen, langspanend	Aluminium alloys, long chipping	3.3535	AlMg3	-550	AlMg3				
			3.4365	AlZnMgCu1,5		AlZnMgCu1,5				
	Kupfer-Legierungen, kurzspanend	Copper alloys, short chipping	2.0402	MS58	-500	CuZn40Pb2				
Kupfer-Legierungen, langspanend	Copper alloys, long chipping	2.0320 2.0975	MS63 CuAl10Ni	300-500	CuZn37 CuAl10Fe5Ni5-C					
S	Titan-Legierungen, mittelfest	Titanium alloys, medium strength	3.7115 3.7164	TiAl5Sn2,5 TiAl6V4	-950	TiAl5Sn2-5 TiAl6V4				
	Titan-Legierungen, hochfest	Titanium alloys, high strength	3.7174	TiAl6Sn2	900-1400	TiAl6V6Sn2				
	Nickelbasis-Legierungen, mittelfest	Nickel based alloys, medium strength	2.4670	NiCr12Al6MoNb	-950	NiCr12Al6MoNb				
	Nickelbasis-Legierungen, hochwarmfest	Heat resistant nickel based alloys, high strength	2.4668	NiCr19Fe19NbMo	900-1400	Inconel 718 NiCr19Fe19Nb5Mo3				

Die angegebenen Schnittwerte sind Startwerte und müssen auf die vorhandenen Bedingungen abgestimmt werden.
The cutting data indicated are starting values and must be adjusted to the prevailing conditions.

Empfohlene max. Zahnvorschübe f_z in mm bei $a_e = 0,75 \times d_1$
 Recommended max. feed per tooth f_z with $a_e = 0,75 \times d_1$
 (d_1 = Fräserdurchmesser Cutter diameter)

Schnittgeschwindigkeit Cutting speed v_c (m/min)

LCPM40M LCP40M LCM45M			LCK10M					LCKP10M LCPK10M									
v_c	XCNT07 SN-TR XCNT07 SN	XCNT09 SN-TR XCNT09 SN	XCNT12 SN-TR XCNT12 SN	XCNT07 EN-TR	XCNT09 EN-TR	XCNT12 EN-TR	v_c	XCNT07 SN-TR XCNT07 SN	XCNT09 SN-TR XCNT09 SN	XCNT12 SN-TR XCNT12 SN	v_c	XCNT07 SN-TR TRXCNT07 SN	XCNT09 SN-TR XCNT09 SN	XCNT12 SN-TR XCNT12 SN	XCNT07 EN-TR	XCNT09 EN-TR	XCNT12 EN-TR
200-260	2,00	2,50	3,00	1,40	1,70	2,00					240-300	1,60	2,00	2,40	1,10	1,40	1,60
160-200	1,70	2,00	2,50	1,20	1,50	1,80					180-220	1,40	1,80	2,10	1,00	1,20	1,40
140-180	1,50	1,80	2,20	1,00	1,30	1,60					160-200	1,20	1,60	1,90	0,80	1,00	1,20
140-180	1,50	1,80	2,20	1,00	1,30	1,60					160-200	1,20	1,60	1,90	0,80	1,00	1,20
130-170	1,50	1,80	2,20	1,00	1,30	1,60					140-180	1,20	1,60	1,90	0,80	1,00	1,20
140-180	1,70	2,00	2,50	1,20	1,50	1,80					160-200	1,40	1,80	2,10	1,00	1,20	1,40
120-140	1,60	2,00	2,20	1,10	1,40	1,50					160-200	1,30	1,60	1,80	0,90	1,10	1,20
140-180	1,20-1,80	1,50-2,30	1,80-2,50	0,80-1,30	1,10-1,60	1,30-2,00					180-240	1,00-1,60	1,20-2,00	1,40-2,30	0,70-1,10	0,80-1,40	1,00-1,60
160-220	0,80	1,20	1,50	0,80	1,20	1,50											
200-260	1,50	2,00	2,50	1,20	1,60	2,00	240-300	1,50	2,00	2,50	200-260	1,50	2,00	2,50	1,20	1,60	2,00
160-200	1,30	1,80	2,20	1,00	1,40	1,80	200-240	1,30	1,80	2,20	180-200	1,30	1,70	2,20	1,00	1,40	1,80
200-240	1,50	2,00	2,50	1,00	1,40	1,70	180-240	1,20	1,40	1,60	200-240	1,50	2,00	2,50	1,00	1,40	1,70
160-200	1,10	1,30	1,50	0,70	0,90	1,00	160-200	1,10	1,30	1,50	160-200	1,10	1,30	1,50	0,70	0,90	1,00
											400-800				1,80	2,00	2,20
											250-400				1,40	1,60	1,80
											80-120				0,50	0,80	1,00
											40-80				0,30	0,50	0,80
											80-120				0,50	0,80	1,00
											40-80				0,30	0,50	0,80

Fräsen mit Wendeschneidplatten
Milling with indexable inserts

Trockenbearbeitung, Pressluftkühlung ist vorteilhaft
Dry machining, air-blast cooling is advantageous



Katalog-Nr. Cat.-No.		SpeedLift									
d ₁	h	d ₂	z	Ident No.	LMT-Code						
66	60	27	6	7070420	SpeedLift T66Z6	-	-	7070421 Form T	TPEW 1303 SR	6119601	T8
80	54	27	8	7070419	SpeedLift T80Z8	-	-	-	-	-	-
66	60	27	6	7070420	SpeedLift T66Z6	7060904 Form S	SPGW 09T3 S	-	-	6119614	T15
80	54	27	8	7070419	SpeedLift T80Z8	-	-	-	-	-	-

Schnittwertempfehlungen Seite 294
Cutting data recommendations page 294

SpeedLift
Wendeschneidplatten
Indexable inserts

N = Anzahl der Schneidkanten N = Number of cutting edges	Schneidstoffsorte Cutting material Ident No.														Für Fräser For cutter Cat.-No.							
	ISO-Code	l	d	s	d ₁	r	LWP40M	LCP40M	LWNS30M	LCPK30M	LCHK30M	LWNS10M	LCPK10M	LCKP10M		LCHK10M	LCN10M	LWNS33M	LCH33M	LBHK95M	LBHK85M	
 N = 4	SPGW 09T3 S	9,25	9,5	3,97	-	0,4															7060826	SpeedLift
 N = 3	TPEW 1303 SR	8	-	3	-	0,4															7070422	SpeedLift

■ = Hauptanwendung First choice																							P
□ = Nebenanwendung Alternative																							M
																							K
																							N
																							S
																							H

N = Anzahl der Schneidkanten N = Number of cutting edges	ISO-Code	l	d	s	d ₁	r	Schneidstoffsorte Cutting material Ident No.										Für Fräser For cutter Cat-No.							
							LWP40M	LCP40M	LWNS30M	LCPK30M	LCHK30M	LWNS10M	LCPK10M	LCKP10M	LCHK10M	LCN10M		LWNS33M	LCH33M	LBHK95M	LBHK85M			
 SPGW 09T3 E	9,25	9,5	3,97	-	0,4											7123517								SpeedLift
 TPEW 1303 E	8	-	3	-	0,4											7123149								SpeedLift
 SPGT 09T3 E	9,25	9,5	3,97	-	0,4											7084957								SpeedLift
 TPET 1303 E	8	-	3	-	0,4											7084958								SpeedLift

■ = Hauptanwendung First choice
 □ = Nebenanwendung Alternative

Sortenbeschreibung/-bezeichnung und ISO-Code ab Seite 424/477
 Description/Designation of grades and ISO-Code starting page 424/477

																								P
																								M
																								K
																								N
																								S
																								H

Bestellbeispiel 1 Stück SpeedLift T66Z6 (Ident No. 7070420) montiert mit 6 Stück Klemmhalter T (Ident No. 7070421)
Order example ... Stück Wendeschneidplatte TPEW 1303 SR I LBHK95M (Ident No. 7070422)
 1 piece SpeedLift T66Z6 (Ident No. 7070420) mounted with 6 pieces tool holders T (Ident No. 7070421)
 ... pieces indexable insert TPEW 1303 SR I LBHK95M (Ident No. 7070422)

Fräsen mit Wendeschneidplatten
Milling with indexable inserts

Schnittwertempfehlungen für SpeedLift Werkzeugsystem Cutting data recommendations for SpeedLift tool system

	Werkstoff	Material	Werkstoff-Nr. Material No.	DIN Bezeichnung Alt DIN Description Old	R _m /UTS (N/mm ²)	DIN Bezeichnung Neu DIN Description New
P	Vergütungsstahl, mittelfest	Heat-treatment steel, medium strength	1.2311	40CrMnMo7	-1100	40CrMnMo7
			1.2312	40CrMnNiMoS8.6	-1150	40CrMnNiMoS8-6
			1.2738	45CrMnNiMo8.6.4	950-1150	45CrMnNiMo8-6-4
	Werkzeugstahl	Tool steel	1.2379	X155CrVMo12 1	-950	X153CrMoV12-1
			1.2358	60CrMoV18-5	850-1000	60CrMoV18-5
			1.2333			
			1.2320			
1.2343	X38CrMoV5 1	950-1400	X37CrMoV5-1			
1.2080	X210Cr12	950-1400	X210Cr12			
K	Grauguss	Grey cast iron	0.6025	GG25	100-400 (120-260 HB)	EN-GJI-250
	Legierter Grauguss	Alloyed grey cast iron	0.6678	GGL-NiCr35 2	150-250 (160-230 HB)	EN-GJLA-XNiCr35-2
	Sphäroguss	Nodular cast iron	0.7060 0.7070	GGG60 GGG70L	400-800 (120-310 HB)	EN-GJS-600-3 EN-GJS-700-2U
H	Gehärteter Stahl/Guss	Hardened steel/cast iron			50-56 HRC	
					56-60 HRC	

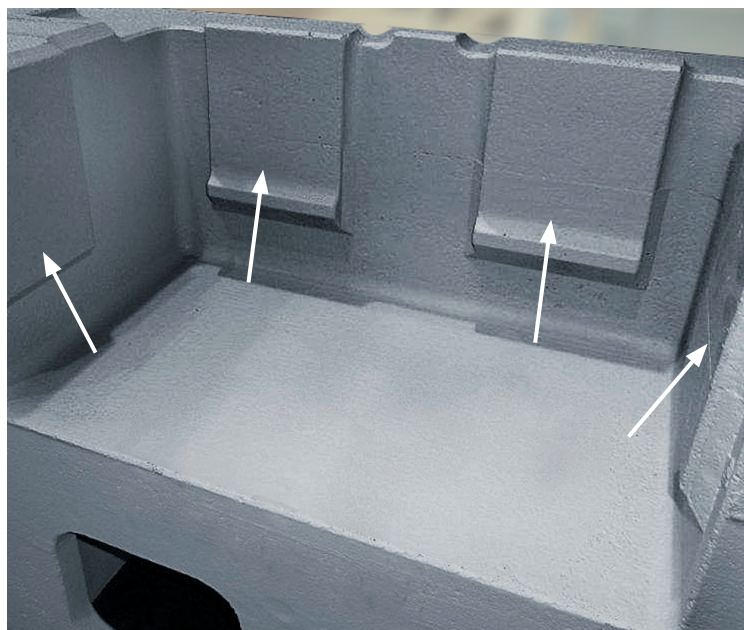

Schichten von Passflächen Finishing of fitting surfaces

Werkzeug Tool:

SpeedLift T80Z8

Wendeplatte Insert:

SPGW 09T3 S | LBHK85M

Werkstoff Material:

GGG40 Sphäroguss
GGG40 Nodular cast iron

Schnittwerte Cutting data:

$v_c = 880$ m/min

$f_z = 0,22$ mm

$a_e = 0,7$ mm

Ergebnis Result:

Das Werkzeug konnte trotz einem Aufmaß von 0,4-0,6 mm ohne Vorschlichtoperation eingesetzt werden.

The tool could be used despite of an oversize of 0.4-0.6 mm without semi-finishing.

Für Wechselplatten For indexable inserts				Für Durchmesser For diameter		Vorschub Feed
TPEW 1303 SR LBHK95M	SPGW 12T3 S LBHK85M	TPE... 1303 E LCKP10M	SPG... 12T3 E LCKP10M	Ø 66	Ø 80	
v_c (m/min)	v_c (m/min)	v_c (m/min)	v_c (m/min)	a_e (mm)	a_e (mm)	f_z (mm/min)
		300–400	300–400	0,40–0,60	0,60–0,80	0,20–0,30
		300–400	300–400	0,40–0,60	0,60–0,80	0,20–0,30
		300–400	300–400	0,40–0,60	0,60–0,80	0,20–0,30
		300–400	300–400	0,40–0,60	0,60–0,80	0,20–0,30
		300–400	300–400	0,40–0,60	0,60–0,80	0,20–0,30
		250–300	250–300	0,40–0,60	0,60–0,80	0,20–0,30
		250–300	250–300	0,40–0,60	0,60–0,80	0,20–0,30
		350–450	350–450	0,40–0,60	0,60–0,80	0,20–0,30
		250–300	250–300	0,40–0,60	0,60–0,80	0,20–0,30
800–1000	800–1000	220–280	220–280	0,40–0,60	0,60–0,80	0,25–0,35
600–800	600–800	220–280	220–280	0,40–0,60	0,60–0,80	0,25–0,35
600–800	600–800	300–350	300–350	0,40–0,60	0,60–0,80	0,25–0,35
300–400	300–400	200–250	200–250	0,40–0,60	0,60–0,80	0,25–0,35
220–250	220–250	180–220	180–220	0,40	0,60	0,15–0,25

Die angegebenen Schnittwerte sind Startwerte und müssen auf die vorhandenen Bedingungen abgestimmt werden.
The cutting data indicated are starting values and must be adjusted to the prevailing conditions.

Das von LMT Kieninger entwickelte Vielzahn-Frässystem Feed-Jet wurde den permanent wachsenden Anforderungen der Zerspanung angepasst und öffnet neue Dimensionen im Planfräsen.

Das Feed-Jet Programm mit hohen Zähnezahlen erfüllt alle Voraussetzungen für höchste Wirtschaftlichkeit im Fräsprozess. Ein Minimum an Bauteilen in Kombination mit der hochpräzisen Fertigung des Fräsergrundkörpers sind Indikatoren für ein schnelles und einfaches Einstellen des Werkzeuges. Die μm -genaue Feinjustierung im Planlauf in Verbindung mit einer hohen Zahl von Schneiden ermöglicht das Erreichen höchster Oberflächenqualitäten und gratarme Bearbeitungen.

- Messerkopfsystem für die Schrupp- und Schlichtbearbeitung
- Maximale Zähnezahl
- Form- und kraftschlüssige Verbindung durch Verzahnung
- μm -genaue Einstellung im Planlauf
- Minimum an Bauteilen und einfaches Handling

The developed Feed-Jet multiple tooth – milling cutter system from LMT Kieninger opens up new face milling perspectives for the ever more stringent demands of chipping systems.

The larger number of teeth offers an excellent opportunity for increased profitability of operation. It contains a minimum of components and its high precision design and manufacture guarantees simple and quick tool setting. The high precision fine adjustment for flat running plus the large number of cutting edges reduces burring and produces top surface quality.

- Suitable for all application from roughing to finishing
- Maximum number of cutting edges
- Positive- and frictional connection due interlocking design
- μm -sensitive adjustment of plane run-out
- Minimum of components and easy handling

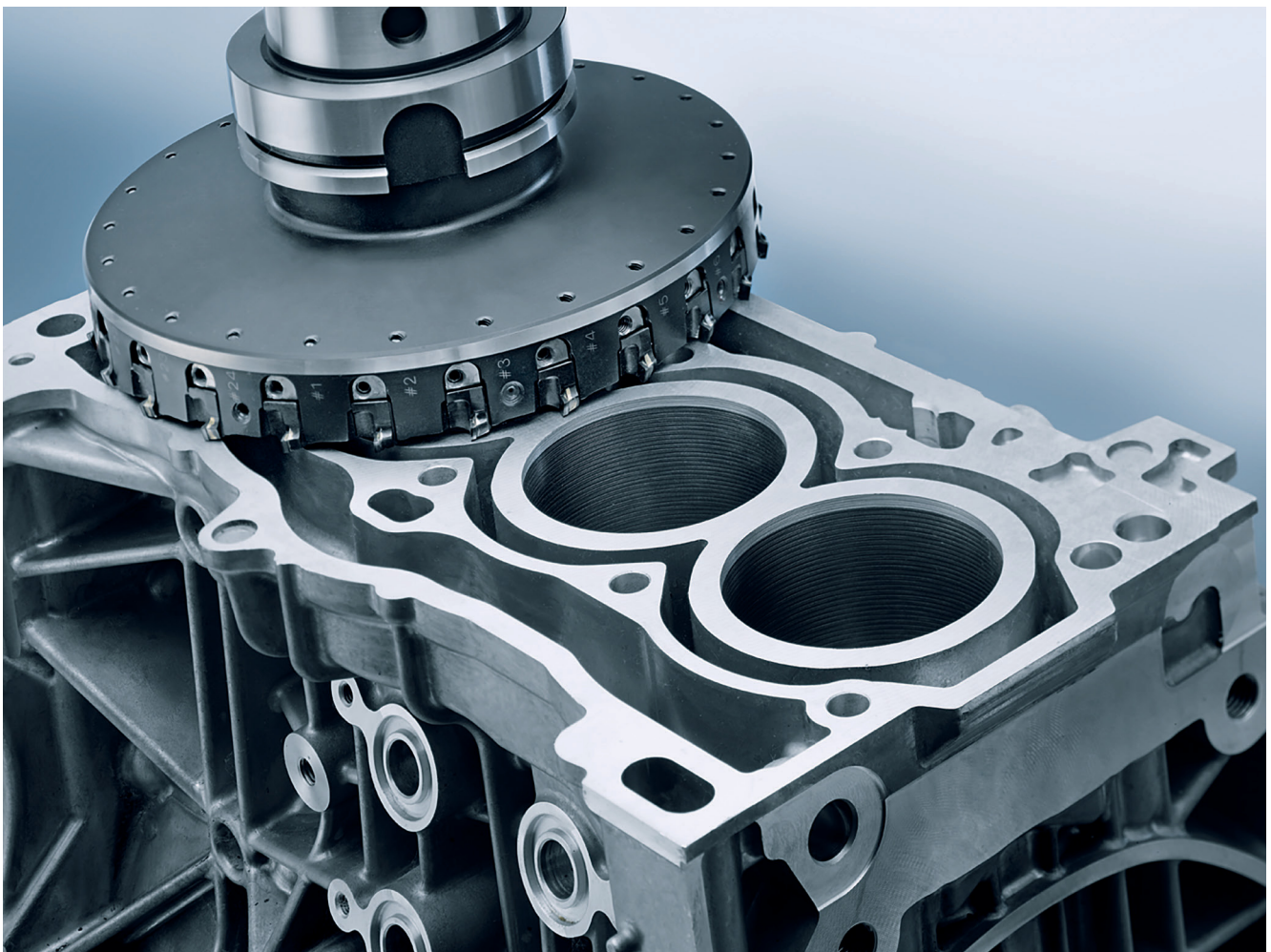

d ₁	h	d ₂	z	LMT-Code	Ident No.
63	100	–	8	Feed Jet D063 Z8 L100 HSK-A 63	9124316
80	100	–	10	Feed Jet D080 Z10 L100 HSK-A 63	9124325

d ₁	h	d ₂ h6	z	LMT-Code	Ident No.
63	40	22	8	Feed Jet D063 Z8 L40 DIN 8030-A	9124288
80	50	27	10	Feed Jet D080 Z10 L50 DIN 8030-A	9124323
100	50	32	12	Feed Jet D100 Z12 L50 DIN 8030-B	9124328
125	63	40	16	Feed Jet D125 Z16 L63 DIN 8030-C	9124329

Schnittwertempfehlungen ab Seite 302
 Cutting data recommendations starting page 302

Einsatzgrenzen Feed-Jet Application Limits Feed-Jet				
LMT-Code	Durchmesser Diameter	z _{max}	Gewicht Weight (kg)	Drehzahl RPM n (1/min.)
Feed Jet D063 Z8 L100 HSK-A 63	63	8	1,91	18.000
Feed Jet D063 Z8 L40 DIN 8030-A	63	8	0,67	18.000
Feed Jet D080 Z10 L100 HSK-A 63	80	10	1,62	18.000
Feed Jet D080 Z10 L50 DIN 8030-A	80	10	1,23	18.000
Feed Jet D100 Z12 L50 DIN 8030-B	100	16	1,78	18.000
Feed Jet D125 Z16 L63 DIN 8030-C	125	18	3,08	14.000

	Sorte Grade	LMT-Code	Ident No.		Sorte Grade	LMT-Code	Ident No.
	LDN10M	Schneideinsatz Eck L3,5 PCD Cartridge 90°	9115413		LDN10M	Schneideinsatz Wiper PCD Cartridge	9116245
	LDN10M	Schneideinsatz Eck L12 PCD Cartridge 90°	9115565		LDN10M	Schneideinsatz Eck CT [Control] PCD Cartridge	9115438
	LDN10M	Schneideinsatz Plan L3,5 PCD Cartridge 75°	9112580		LDN10M	Schneideinsatz Plan CT [Control] PCD Cartridge	9115014
	LDN25M	Schneideinsatz Eck L6,0 PCD Cartridge 90°, R0,4	7140627		LDN25M	Feed-Jet Plus Schneideinsatz Eck L12 PCD Cartridge 90° PLUS	9206475
	LDN25M	Schneideinsatz Eck L6,0 PCD Cartridge 90°, 0,2 x 45°	7140683				

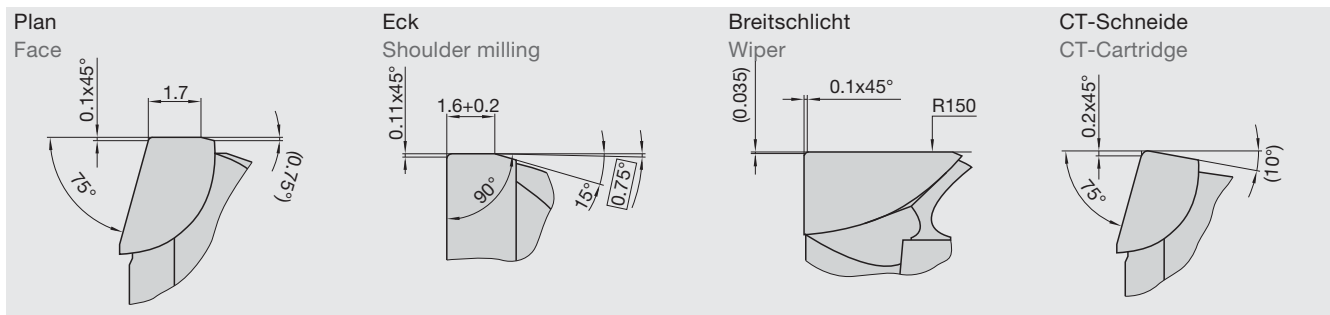

Feed-Jet
Einbauteile/Ersatzteile
Spare parts

	LMT-Code	Ident No.		LMT-Code	Ident No.
	Axialverstellkeil Axial-wedge	9112535		Kühlmitteleckel für Ø 125 Coolant disc for Ø 125	9113601
	IKZ-Schraube M10 x 25 für Ø 63 Coolant screw M10 x 25 for Ø 63	9114791		Zylinderschraube DIN 912 M4 x 20 10.9 Fixing screw DIN 912 M4 x 20 10.9	6104446
	IKZ-Schraube M12 x 30 für Ø 80 Coolant screw M12 x 30 for Ø 80	9116644		Differential-Schraube DS 05 LR 16 gebr. Diff.-screw DS 05 LR 16	9137328
	Kühlmitteleckel für Ø 100 Coolant disc for Ø 100	9136417		Senkschraube DIN 7991 M4 x 10 8.8 Screw DIN 7991 M4 x 10 8.8	6103794

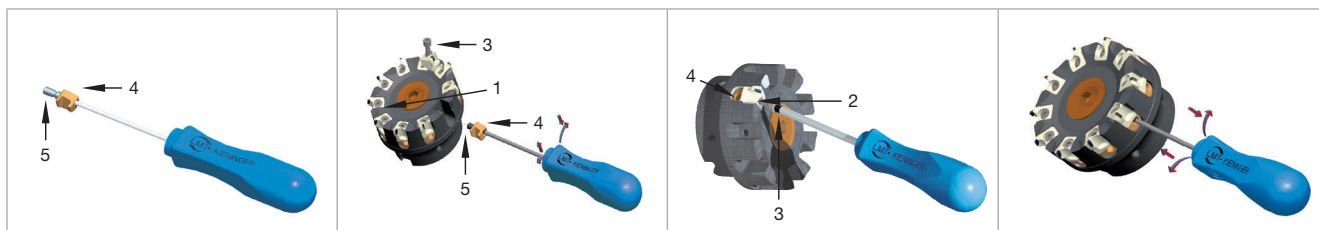

Allgemein

- Bei Montage ist auf Sauberkeit und Leichtgängigkeit zu achten. Die verwendeten Teile sind auf Beschädigungen hin zu überprüfen.
- Bei Ersatz von Bauteilen dürfen nur Originalteile bzw. Teile mit org. Spezifikation verwendet werden.
- Gleitflächen und Schrauben sind leicht gefettet zu montieren.
- Für den bestimmungsgemäßen Einsatz ist ausschließlich der Anwender verantwortlich.
- Die Schneideneinstellung darf nur zum größeren Maß hin erfolgen, ein Zurückdrehen der Einstellelemente ist möglich, erfordert aber eine Neueinstellung gem. Anleitung so dass die Schneidkassette immer unter einer axialen Vorspannung steht.

Grobeinstellung

- Montieren der Gewindespindel (5) in den Axialkeil (4); ca. 1–1,5 Umdrehungen einschrauben;
Achtung: Linksgewinde!
- Axialverstellkeil (4) in den Messerkopf (1) bis zum Anschlag einschrauben
- Schneidkassette (2) in den Messerkopf (1) einsetzen; Schraube (3) montieren und leicht von Hand anlegen.
- Einstellen des Axialmaßes durch Drehen der Gewindespindel (5) im Gegenuhrzeigersinn.
- Voreinstellen aller Kassetten auf ca. 0,01 – max. 0,02 mm unter Nennhöhe

Anmerkung:

Konstruktionsbedingt erhöht sich durch das Einstellen die Vorspannkraft auf die Befestigungsschraube (3). Sollte diese bereits vor dem Erreichen des Voreinstellmaßes so groß werden dass eine ordnungsgemäße Verstellung nicht, oder nur unter erheblichen Kraftaufwand, möglich ist so ist die Befestigungsschraube etwas zu lockern und danach die Einstellung fortzuführen.

- Nach dem Voreinstellen müssen die Befestigungsschrauben (3) mit einem Drehmomentschlüssel auf einen Wert von 3 Nm angezogen werden. Sollte das bereits vorhandene Ist-Moment deutlich über 3 Nm liegen (s. Anmerkung) kann es zu Schwierigkeiten bei der Feineinstellung kommen. Die betreffende Schraube ist dann soweit zu lockern dass sie noch ein verbleibendes Anzugsmoment von 3 Nm hat.

Feineinstellung

- Einstellung auf Nennhöhe durch Drehen der Gewindespindel (5) im Gegenuhrzeigersinn.
- Überprüfung der Einstellung.
Erreichbare Einstellgenauigkeit: 4 µm
- Überprüfung der Anzugsmomente der Kassettensbefestigungsschraube (3). Dieses Anzugsmoment muss nun mindestens 5 Nm betragen. (Höhere Werte sind möglich s. Anmerkung und brauchen nicht korrigiert zu werden)

General

- Make sure that all parts are clean and can be moved easily. Please verify that no damaged or worn parts are assembled.
- Only original Kieninger components to be used.
- Adjustment should only be done in up direction. In case that screwing down is required, go back to the starting point. This always ensures there is a pretension.

Pre-adjustment

- Screw in the thread pin (5) into the wedge (4); 1–1.5 revolutions.
Caution: left hand thread!
- Screw in the wedge (4) into the the cutter (1) body as deep as possible.
- Put the cartridge (2) into the cutter (1) body. Tighten the screw slightly.
- Setting the cartridges by turning the threaded pin (5) counter clockwise. Pre-adjust the cartridges to approx 0.01 – max 0.02 mm below the nominal height.

Note:

During height adjustment, screw will become tight (3). In case the screw might become too toght and only excessive torque is needed to move the cartridge, please loosen the clamping screw and re-adjust.

- After pre-adjustment the xing screw (3) have to be tightened with a torque wrench to 3 Nm. An actual moment above 3 Nm can lead to diculties in the fine adjustment. In this case the xing screw has to be loosen to 3 Nm.

Fine adjustment

- Adjusting to nomial height by turning the thread pin (5) counter clockwise.
- Verify the adjustment. Available adjustment accuracy: 4 µm
- Verify the tightening torque of the cartridge xing screw (3). This torque must at least 5 Nm. (Higher values are possible see note and do not have to be connected)

Zusätzlich zum Feed-Jet Vielzahn-Frässystem für die Schlichtbearbeitung entwickelte LMT Kieninger die Schruppversion Feed-Jet PLUS. Bei diesem Frässystem liegt der Focus auf einer höchsten Zerspanungsleistung bei der Schrupp-Bearbeitung von Aluminium Bauteilen.

Merkmale:

- Hohe Zähnezahl
- Kraft- und formschlüssige Verbindung zwischen Grundkörper und Schneide
- Einsatz von PKD-Schneidkassetten
- µm-genaue Feineinstellung der Schneiden

Kundennutzen:

- hohe Zerspanungsrate
- Reduzierung von Vibrationen und höchste Sicherheit beim Fräsen
- Verringerung der Taktzeit
- hohe Oberflächenqualität

Die axial positive Anstellung der Schneide ermöglicht einen sehr guten Abtransport der Späne, weg vom Werkstück.

Ein Minimum an Bauteilen in Kombination mit hochpräziser Fertigung der Fräser-Grundkörper sind Indikatoren für ein schnelles und einfaches Einstellen des Werkzeuges.

In addition to the Feed-Jet multi-tooth milling system for finishing, LMT Kieninger developed the roughing version Feed-Jet PLUS. This milling system focuses on the highest cutting performance during roughing of aluminum components.

Features:

- High number of teeth
- Positive and non-positive connection between body and cutting edge
- Use of PCD cutting cassettes
- Micron-precision fine adjustment of the cutting edges

Customer benefits:

- High cutting rate
- Reduction of vibrations and maximum safety during milling
- Reduction of cycle time
- Excellent surface quality

The axial positive adjustment of the cutting edge allows for excellent removal of the swarf away from the workpiece.

A minimum of components combined with high-precision production of the milling body are indicators of quick and easy adjustment of the tool.

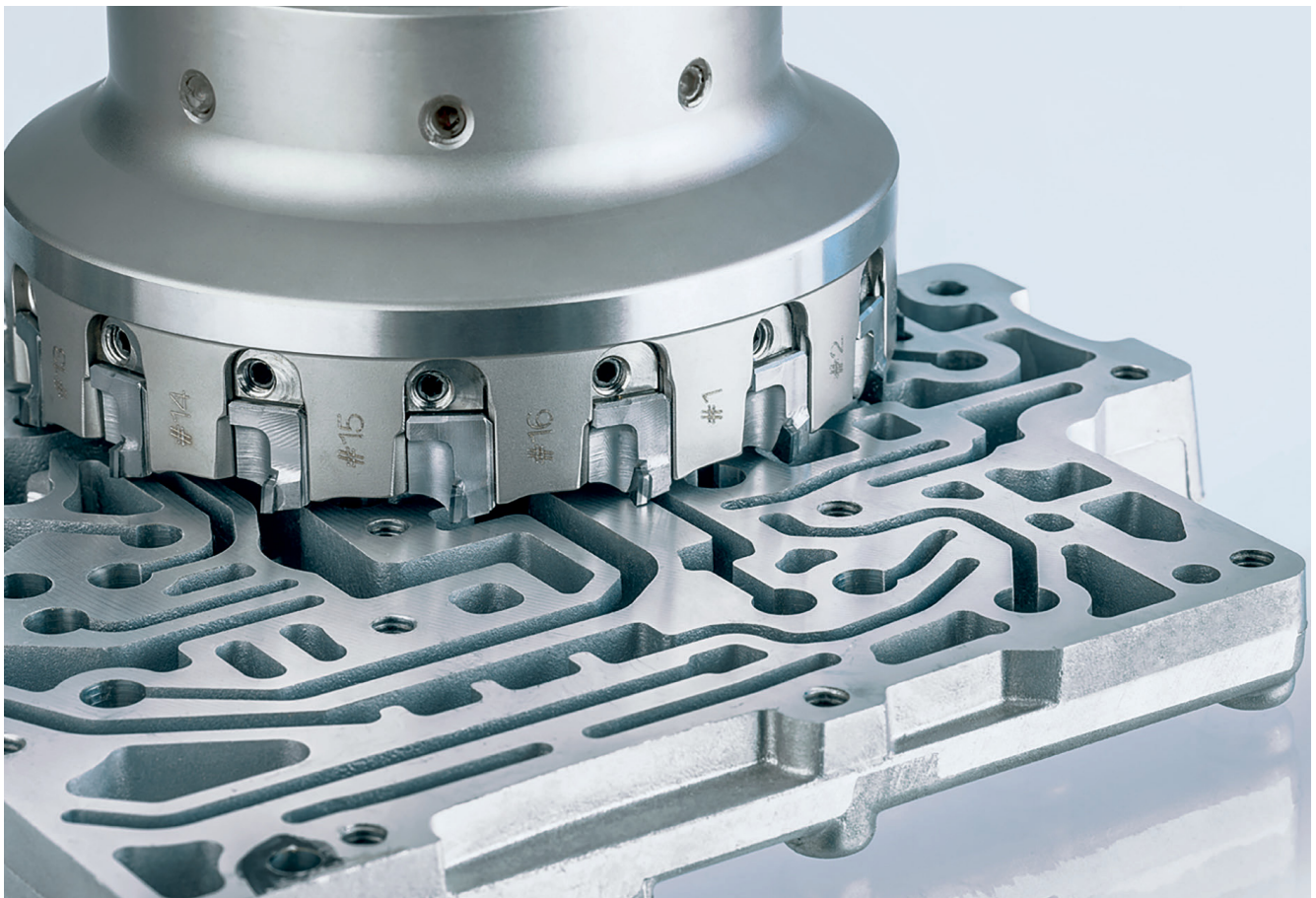

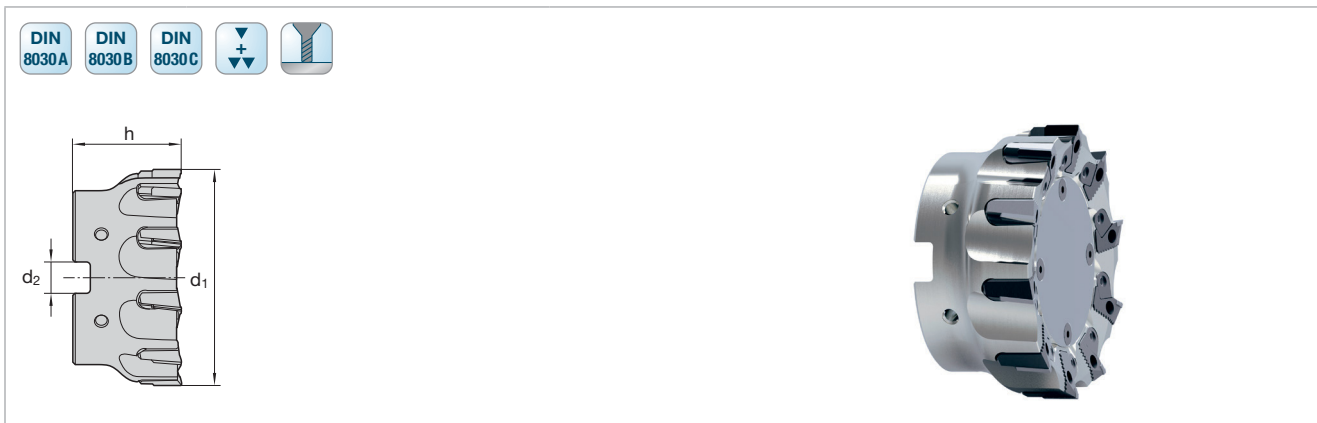

d ₁	h	d ₂ h6	z	LMT-Code	Ident No.
63	50	22	6	Feed-Jet Plus D063 Z06 L50 DIN8030-A R	7010869
80	50	27	7	Feed-Jet Plus D080 Z07 L50 DIN8030-A R	7010880
100	50	32	10	Feed-Jet Plus D100 Z10 L50 DIN8030-B R	7008401
125	50	40	12	Feed-Jet Plus D125 Z12 L50 DIN8030-B R	7008402
160	50	40	14	Feed-Jet Plus D160 Z14 L50 DIN8030-C R	7008403

PKD-Schneideinsatz für Feed-Jet PLUS auf Seite 298
 PCD-cartridge for Feed-Jet PLUS on page 298

Schnittwertempfehlungen ab Seite 302
 Cutting data recommendations starting page 302

PKD-Schneideinsatz für Feed-Jet und Feed-Jet PLUS PCD-cartridge für Feed-Jet and Feet-Jet PLUS

Hohe Schnittleistungen sowie spezielle Anforderungen an die Oberfläche wie z. B. definierte Rauhtiefen, Ebenheit und Traganteil stellen hohe Anforderungen speziell an den PKD-Schneideinsatz.

Die Lösung bietet das umfangreiche Standard-Sortiment an verschiedenen, für den jeweiligen Anwendungsfall angepassten Geometrien.

Das speziell für die Schneideinsätze angebotene Servicepaket beinhaltet den definierten Nachschliff bzw. die Neubestückung.

The special requirements to the PCD-cartridge are high cutting depth, as well as special demands to the surface, i.e. defined surface roughness, even surface and percentage contact area.

An extensive standard assortment of various geometries, suiting to each individual application is the solution.

The service, offered specially for these inserts include the defined regrinding, resp. re-tipping.

Werkstoff Material	Werkstoff-Nr. Material No.	DIN Bezeichnung Alt DIN Description Old	R _m /UTS (N/mm ²)	DIN Bezeichnung Neu DIN Description New	Schnittgeschwindigkeit Cutting speed	75°	90°	90°
					v _c (m/min)	Plan 3,5	Eck 3,5	Eck 12
					LCN10M LCN25M	a _p max f _z max	a _p max f _z max	a _p max f _z max
N Aluminium-Legierungen, kurzspanend Aluminium alloys, short chipping	3.2581	G-AISI12	-400	G-IGK-AISI12	bis up to 5000	3,00	3,00	6,00
						0,05-0,15	0,05-0,15	0,05-0,20
Aluminium-Legierungen, langspanend Aluminium alloys, long chipping	3.3535 3.4365	AlMg3 AlZnMgCu1,5	-550	AlMg3 AlZnMgCu1,5	bis up to 5000	3,00 0,05-0,15	3,00 0,05-0,15	6,00 0,05-0,20

Planfräsen mit Feed-Jet Face milling with Feed-Jet

Die Angabe der Schnittparameter für das Planfräs-System Feed-Jet sind nur als Richtwerte zu betrachten.

Auf Wunsch erstellen wir Ihnen gerne eine Schnittwertempfehlung, die genau auf Ihren Anwendungsprozess abgestimmt ist.

Cutting data recommendations to be considered as reference only.

Please contact us for specific parameters recommendations.

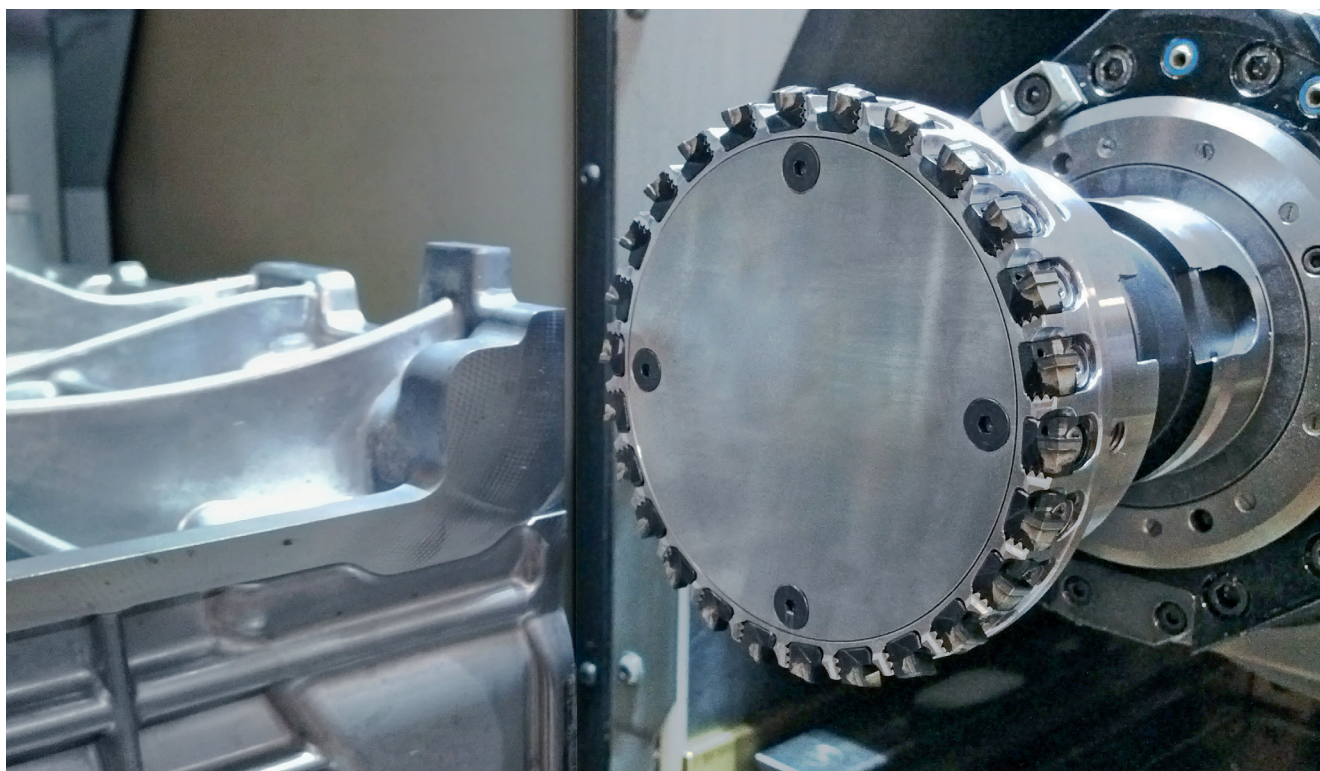

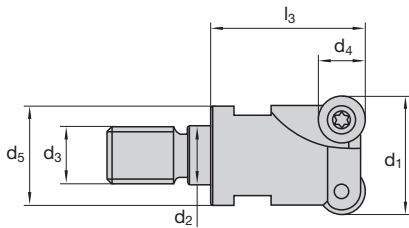

Katalog-Nr. Cat.-No.								ECZ / ECC				
d ₁	d ₄	l ₃	d ₅	d ₃	d ₂	z	Ident No.	LMT-Code				
AF = Schlichten Application Finishing												
15	7	25	13	M8	8,5	2	7056510	ECZ R07.015TR 25-02-I-AF	RD... 07	6119627		1048326
20	7	30	18	M10	10,5	3	9082897	ECC R07.020TS 30-03-I-AF		1044972		T08
20	10	30	18	M10	10,5	2	9082898	ECC R10.020TS 30-02-I-AF	RD... 10	1044981		1048335
24	12	35	21	M12	12,5	2	9082896	ECC R12.024TF 35-02-I-AF	RD... 12			T15
25	7	35	21	M12	12,5	5	9082895	ECC R07.025TF 35-05-I-AF	RD... 07	1044972		1048326
												T08
25	10	35	21	M12	12,5	3	9082894	ECC R10.025TF 35-03-I-AF	RD... 10	1044981		1048335
												T15
30	7	40	28	M16	17	5	7056511	ECZ R07.030TH 40-05-I-AF	RD... 07	1044972		1048326
												T08
30	10	40	28	M16	17	4	7056512	ECZ R10.030TH 40-04-I-AF	RD... 10	1044981		1048335
32	12	40	29	M16	17	4	9091058	ECC R12.032TH 40-04-I-AF	RD... 12			T15
35	10	40	29	M16	17	4	7056513	ECZ R10.035TH 40-04-I-AF	RD... 10			
42	10	40	30	M16	17	5	7056514	ECZ R10.042TH 40-05-I-AF				
AFR = Schlichten – Schruppen Application Finishing – Roughing												
35	12	40	29	M16	17	4	9082892	ECC R12.035TH 40-04-I-AFR	RD... 12	1044981	7036396	1048335
42	12	40	29	M16	17	5	9082891	ECC R12.042TH 40-05-I-AFR			T15	T15
AR = Schruppen Application Roughing												
32	16	40	29	M16	17	2	7025927	ECC R16.032TH 40-02-I-AR	RD... 16	1044990		1048344
42	16	40	29	M16	17	3	7025942	ECC R16.042TH 40-03-I-AR				T20

Fräser auch verfügbar in Zoll-Abmessungen
 Cutters also available in inch dimensions

Schnittwertempfehlungen siehe Seite 312
 Cutting data recommendations see page 312

<p>AF = Schlichten geeignet zum Schlichten und leichten Schruppoperationen Merkmale: ■ Spanwinkel 0° ■ keine zusätzliche Sicherheitsschraube ■ kein überdeckter Plattensitz</p>	<p>AF = Application Finishing suitable for finishing and light roughing operations Features: ■ chip angle 0° ■ no additional safety screw ■ no covered insert seat</p>
<p>AFR = Schlichten + Schruppen ebenfalls geeignet zum Schlichten bis hin zu mittleren Schruppoperationen Merkmale: ■ Spanwinkel 0° ■ zusätzliche Sicherheitsschraube ■ kein überdeckter Plattensitz</p>	<p>AFR = Application Finishing + Roughing also suitable for finishing and up to medium grade roughing operations Features: ■ chip angle 0° ■ additional safety screw ■ no covered insert seat</p>
<p>AR = Schruppen, ACU-Jet plus geeignet zum Schruppen von hochfesten Werkzeugstählen und hoch legierten Werkstoffen, z. B. im Gesenk- und Formenbau oder in der Luft- und Raumfahrttechnologie Merkmale: ■ Spanwinkel 8° positiv ■ überdeckter Plattensitz</p>	<p>AR = Application Roughing, ACU-Jet plus suitable for roughing high-strength tool steels and high-alloy materials, e. g. in the die and mould industry or in the aerospace technology Features: ■ chip angle 8° positive ■ covered insert seat</p>

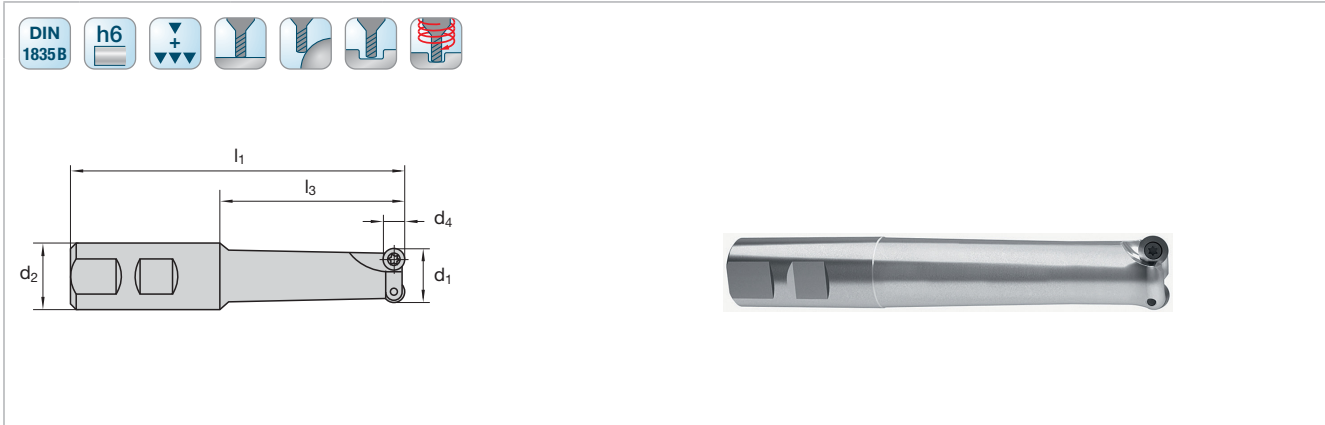

Katalog-Nr. Cat.-No.							ECZ			
d ₁	d ₄	l ₁	l ₃	d ₂	z	Ident No.	LMT-Code			
25	10	85	35	20	2	7056515	ECZ R10.025BI 35-02-I-AF	RD... 10	1044981	1048335 T15
25	10	131	75	25	2	7056516	ECZ R10.025BN 75-02-I-AF			
25	10	156	100	25	2	7056517	ECZ R10.025BN 100-02-I-AF	RD... 12	1045105	
32	12	85	35	20	3	7056518	ECZ R12.032BB 35-03-I-AF			
32	12	135	75	32	3	7056519	ECZ R12.032BN 75-03-I-AF			
32	12	160	100	32	3	7056520	ECZ R12.032BN 100-03-I-AF			
40	12	125	75	32	4	7056521	ECZ R12.040BF 75-04-I-AF			
40	12	180	120	32	4	7056522	ECZ R12.040BF 120-04-I-AF			

Schnittwertempfehlungen siehe Seite 312
 Cutting data recommendations see page 312

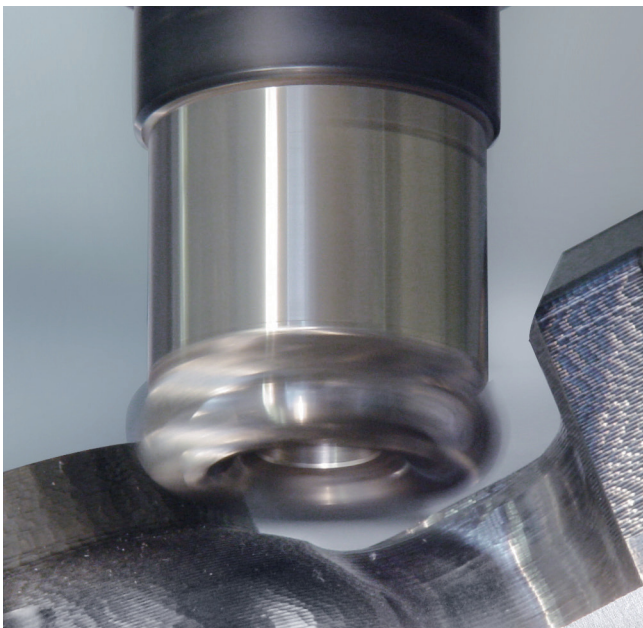

Schruppen eines Unterstempels
 Roughing of a stamping die

Werkzeug Tool:
 ACU-Jet plus, FCC R16.066AN 50-06-I-AR

Wendepatte Insert:
 RDKX 1604 MO-TK | LC228E

Werkstoff Material:
 40 CrMoS 8.6 | R_m = 950–1150 N/mm²

Schnittwerte Cutting data:
 v_c = 162 m/min a_e = 44 mm
 n = 780 m/min a_p = 1,5 mm
 f_z = 1,28 mm Q = 400 cm³/min
 v_f = 6000 mm/min

Ergebnis Result:
 Standzeit ca. 90 min
 Tool life ca. 90 min

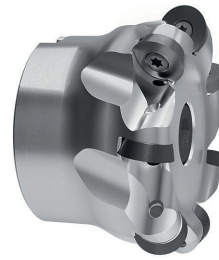
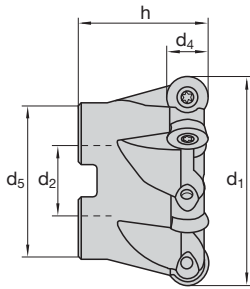

Katalog-Nr. Cat.-No.							FCC				
d ₁	d ₄	h	d ₅	d ₂	z	Ident No.	LMT-Code				
AFR = Schichten – Schruppen Application Finishing – Roughing											
52	12	40	40	22	6	9082887	FCC R12.052AN 40-06-I-AFR	RD... 12	1044981	7036396 T15	1048335 T15
52	16	40	48	22	5	9082886	FCC R16.052AN 40-05-I-AFR	RD... 16	1044990	9131295 T20	1048344 T20
63	16	50	54	27	5	7056506	FCC R16.063AN 50-05-I-AFR				
66	16	50	57	27	6	9082878	FCC R16.066AN 50-06-I-AFR				
AR = Schruppen Application Roughing											
52	12	40	40	22	5	7034888	FCC R12.052AN 40-05-I-AR	RD... 12	1045105		1048335 T15
52	16	50	46	22	5	7025945	FCC R16.052AN 50-05-I-AR	RD... 16	1044990		1048344 T20
66	16	50	57	27	6	7025946	FCC R16.066AN 50-06-I-AR				
80	16	50	60	27	7	7025947	FCC R16.080AN 50-07-I-AR				
100	16	55	78	32	8	7025948	FCC R16.100AN 55-08-AR				
125	16	55	90	40	9	7035163	FCC R16.125AN 55-09-AR				
160	16	55	120	40	10	7035165	FCC R16.160AN 55-10-AR				

Fräser auch verfügbar in Zoll-Abmessungen
 Cutters also available in inch dimensions

Schnittwertempfehlungen siehe Seite 312
 Cutting data recommendations see page 312

Fräser mit Wertschneidplatten
 Milling with indexable inserts

Beim Schruppen von Werkzeugstahl, Rostfreiem Stahl oder gar Superlegierungen kommen viele Werkzeugsysteme schnell an ihre Grenzen. Speziell hierfür hat LMT Kieninger das Frässystem ACU-Jet Double6 überarbeitet und um die Wendeschneidplatte Ø 12 mm ergänzt.

Das Ergebnis ist ein Werkzeug, das maximale Stabilität und Prozesssicherheit bietet und aufgrund doppelseitiger Verwendung der Schneidplatten durch hohe Wirtschaftlichkeit punktet. Bis zu 12 Einsätze pro Platte sind möglich.

Merkmale:

- Doppelseitige Wendeschneidplatte für bis zu 12 Einsätze
- Verdrehsicherheit der Schneidplatte für mehr Prozesssicherheit
- 4 Hochleistungsarten für die Bearbeitung von ISO P, M, K und S
- 2 unterschiedliche Geometrien stehen zur Verfügung:
R = schwere Schruppoperationen, stabile Schneidkante
M = mittlere Bearbeitungen, positive Geometrie

Many tool systems quickly reach their limits when roughing tool steel, stainless steel or even superalloys. LMT Kieninger has redesigned the ACU-Jet Double6 especially for this purpose and added the Ø 12 mm indexable insert.





The result is a tool which offers maximum stability and process reliability and which impresses with improved economy due to the double-sided use of the cutting inserts. Up to 12 applications per insert are possible.

Features:

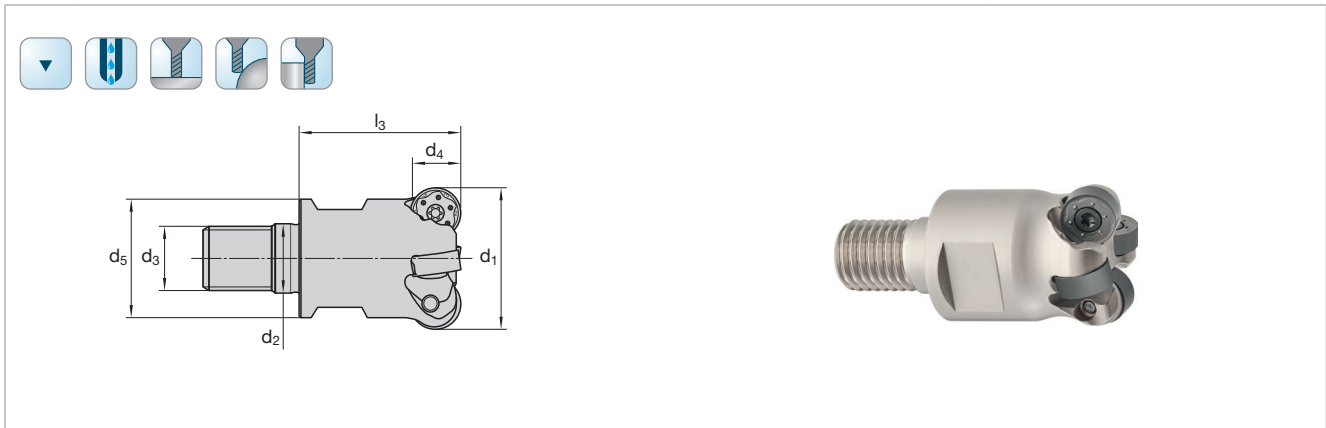
- Double-sided indexable insert for up to 12 applications
- Antitwist protection of the insert for more process reliability
- 4 high performance grades for machining ISO P, M, K and S
- 2 different geometries available:
R = heavy roughing operations, stable cutting edge
M = average machining, positive geometry









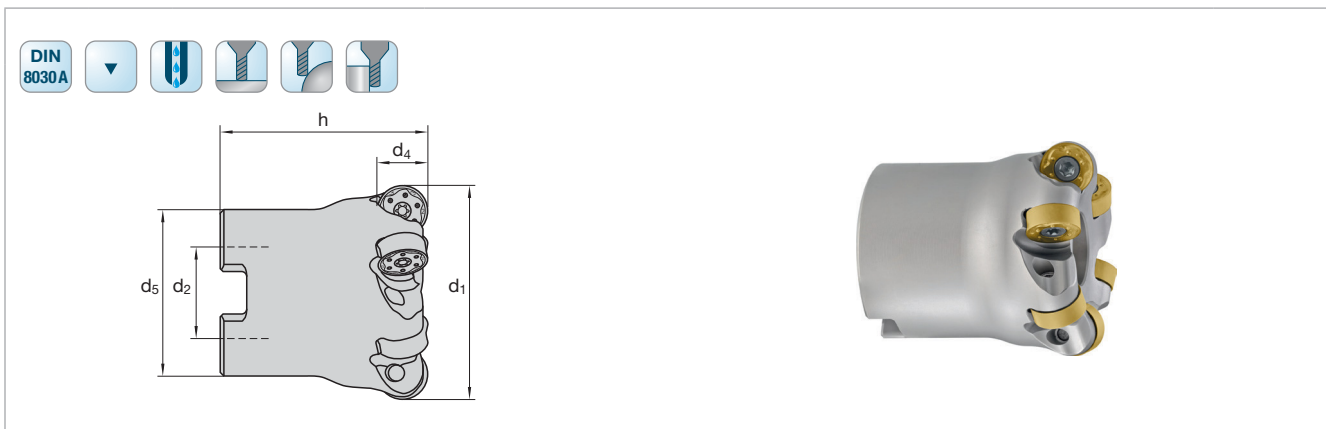

Katalog-Nr. Cat.-No.								ECC			
d ₁	d ₄	l ₃	d ₅	d ₃	d ₂	z	Ident No.	LMT-Code			
32	12	40	29	M16	17	4	7200034	ECC R12.032TH40-04-I-Double6			1048335 T15
35	12	40	29	M16	17	4	7200054	ECC R12.035TH40-04-I-Double6			
40	12	40	29	M16	17	5	7200035	ECC R12.040TH40-05-I-Double6			
42	12	40	29	M16	17	5	7200036	ECC R12.042TH40-05-I-Double6			

Schnittwertempfehlungen siehe Seite 312
 Cutting data recommendations see page 312

ACU-Jet Double6 Premium
Kopierfräser
 Copy cutters





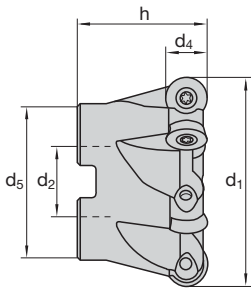

Katalog-Nr. Cat.-No.								FCC			
d ₁	d ₄	h	d ₅	d ₂	z	Ident No.	LMT-Code				
42	12	40	36	16	5	7200037	FCC R12.042AN40-05-I-Double6			1048335 T15	
50	12	50	40	22	6	7200038	FCC R12.050AN50-06-I-Double6				
52	12	50	40	22	6	7200039	FCC R12.052AN50-06-I-Double6				
63	12	50	54	27	7	7200040	FCC R12.063AN50-07-I-Double6				
66	12	50	57	27	7	7200041	FCC R12.066AN50-07-I-Double6				

Schnittwertempfehlungen siehe Seite 312
 Cutting data recommendations see page 312

Fräsen mit Wendeschneidplatten
 Milling with indexable inserts



Katalog-Nr. Cat.-No.							FCC				
d ₁	d ₄	h	d ₅	d ₂	z	Ident No.	LMT-Code				
52	16	50	46	22	5	7031572	FCC R16.052AN 50-05-I-Double 6	RN... 16	1044990	9131295	1048344
63	16	50	57	27	6	7082852	FCC R16.063AN 50-06-I-Double 6			T20	T20
66	16	50	57	27	6	7031573	FCC R16.066AN 50-06-I-Double 6				
80	16	50	60	27	7	7031574	FCC R16.080AN 50-07-I-Double 6				
100	16	55	78	32	8	7031575	FCC R16.100AN 55-08-Double 6				

Schnittwertempfehlungen siehe Seite 312
Cutting data recommendations see page 312

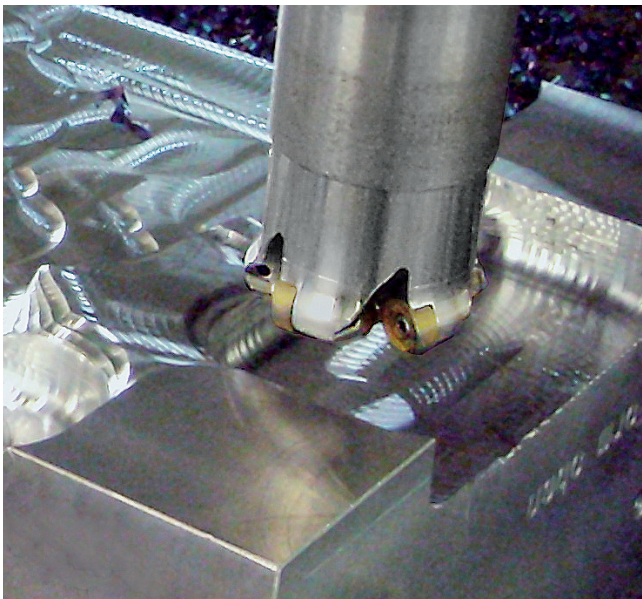

Formplatte
Mold plate

Werkzeug Tool:
ACU-Jet Double6, R16.052AN 50-05-I-Double6

Wendeplatte Insert:
RNKX 1605 MO | LCPK20M

Werkstoff Material:
1.2343 / X38CrMoV5-1

Schnittwerte Cutting data:
 $v_c = 175 \text{ m/min}$ $v_f = 3500 \text{ mm/min}$
 $n = 850 \text{ m/min}$ $a_e = 48 \text{ mm}$
 $f_z = 0,82 \text{ mm}$ $a_p = 2 \text{ mm}$

Ergebnis Result:
Standzeit je Wendeschneidplatte ca. 180 min.
Tool life each insert approx. 180 min.

N = Anzahl der Schneidkanten N = Number of cutting edges	ISO-Code	l	d	s	d ₁	r	Schneidstoffsorten Cutting materials Ident No.										Für Fräser For cutter Cat-No.			
							LC280QN	LCKP28M	LCKP30M	LCKP20M	LC228E	LCP35M	LCP40M	LCPK10M	LWNS10M	LCH05M		LBHK85M		
								RDHX 0702 MO S	-	7	2,38	2,7	-							
RDHX 0702 MO S	-	7 ±0,01	2,38	2,7	-												1055757			
RDHX 0702 MO E	-	7	2,38	2,6	-														7035551	
RDKX 1003 MO E	-	10	3,18	3,8	-						7113569									
RDKX 1003 MO S	-	10	3,18	3,8	-		7091246	7119315												
RDHW 1003 MO S	-	10	3,18	3,8	-							1068613	1068623							
RDHW 1003 MO S	-	10 ±0,01	3,18	3,8	-												1055759			
RDHX 1003 MO S	-	10	3,18	3,8	-						9165726								7035552	
RDKX 12T3 MO E	-	12	3,97	3,8	-							7113570								
RDKX 12T3 MO S	-	12	3,97	3,8	-		7091253	7119316			9147885									
RDHX 12T3 MO S	-	12	3,97	3,8	-						9165728		1070159	1070160					7035553	
RDHX 12T3 MO S	-	12 ±0,01	3,97	3,8	-												1055761			

■ = Hauptanwendung First choice
□ = Nebenanwendung Alternative
Sortenbeschreibung/-bezeichnung und ISO-Code ab Seite 424/477
Description/Designation of grades and ISO-Code starting page 424/477

■	■	■	■	■	□															P
■	■																			M
■	■					□	□	■	□	■										K
																				N
																				S
																	■	■		H

Fräsen mit Wendeschneidplatten
Milling with indexable inserts

							Schneidstoffsorten Cutting materials Ident No.										Für Fräser For cutter		
N = Anzahl der Schneidkanten N = Number of cutting edges	ISO-Code	l	d	s	d ₁	r	LC280QN	LCKP28M	LCKP30M	LCKP20M	LCKP28M	LCP35M	LCP40M	LCPK10M	LWNS10M	LCH05M	LBHK85M	Cat-No.	
 	RDKX 1604 MO E	-	16	4,76	5,2	-						7112984						ECC FCC ECZ FCZ	
	RDKX 1604 MO S	-	16	4,76	5,2	-		7041694	7119317		7004651						7035554		
	RDHW 1604 MO S	-	16	4,76	5,2	-							1068616	1068627					
	RDHX 1604 MO S	-	16 ±0,01	4,76	5,2	-											1055762		
 <p>N = abhängig von der Einstelltiefe depending on depth of positioning</p>	RDKT 0702 MO-TT	-	7	2,38	2,7	-	7077266 ¹⁾											ECC ECZ FCC FCZ	
	RDKT 1003 MO-TT	-	10	3,18	3,8	-	7077268 ¹⁾												
	RDKX 12T3 MO-TT	-	12	3,97	3,8	-	7077271 ¹⁾												
	RDKT 1604 MO-TT	-	16	4,76	5,2	-	7077270 ¹⁾												
							■	■	■	■	■	■	□					P	
							□	■	■	■	■	■	■	■	■	■	■	■	M
								■	■	■	■	□	□	■	■	■	■	■	K
																			N
							□												S
																	■	■	H

■ = Hauptanwendung First choice
□ = Nebenanwendung Alternative

Sortenbeschreibung/-bezeichnung und ISO-Code ab Seite 424/477
Description/Designation of grades and ISO-Code starting page 424/477

¹⁾ nur ohne zusätzliche Klemmschraube verwenden
without additional acrow

		Schneidstoffsorten Cutting materials Ident No.										Für Fräser For cutter Cat-No.									
N = Anzahl der Schneidkanten N = Number of cutting edges	ISO-Code	l	d	s	d ₁	r	LC280QN	LCS40M	LCM35M	LCKP20M	LCKP28M		LCPK20M	LCKP30M	LCPK15M	LWNS10M	LCH05M	LBHK85M			
 	RNLU 1204 MO M	-	12	4,75	4,57	-		7207971	7207970										ECC FCC		
	RNLU 1204 MO R	-	12	4,75	4,57	-							7222375	7222374							
N = 2																					
 	RNKX 1605 MO	-	16	4,76	5,2	-				7089594		7083759							FCC		
N = 2																					
■ = Hauptanwendung First choice □ = Nebenanwendung Alternative Sortenbeschreibung/-bezeichnung und ISO-Code ab Seite 424/477 Description/Designation of grades and ISO-Code starting page 424/477																					
								□	□	■		■	■	■						P	
								□	■	□			□	□						M	
										■		□	□	■						K	
																				N	
								■		□										S	
																				H	

Fräser mit Wendeschneidplatten
Milling with indexable inserts

ACU-Jet Double6 Premium
Schnittwertempfehlungen
Cutting data recommendations

	Werkstoff	Material	Werkstoff-Nr. Material No.	DIN Bezeichnung Alt DIN Description Old	R_m/UTS (N/mm²)	DIN Bezeichnung Neu DIN Description New
P	Unlegierter Baustahl + Automatenstahl	Plain carbon steel + free cutting steel	1.0570	St52-3	-700	S355J2G3
			1.1730	C45	-800	C45U
			1.0715	9SMn28	-700	11SMn30
			1.1191 1.7219	Ck45 26CrMo4	500-950	C45E 26CrMo4-2
	Vergütungsstahl, mittelfest	Heat-treatment steel, medium strength	1.7225 1.8159	42CrMo4 51CrV4	500-950	42CrMo4 51CrV4
	Stahlguss	Cast steel	1.0416	GS40	-950	GS40
	Einsatzstahl	Case hardening steel	1.7131	16MnCr5	-950	16MnCr5
	Rost- und säurebe- ständiger Stahl, ferritisch, martensitisch	Stainless steel, ferritic, martensitic	1.4006	X10Cr13	500-950	X12Cr13
			1.4104	X12CrMoS17		X14CrMoS17
			1.4122	X35CrMo17		X39CrMo17-1
	Vergütungsstahl, hochfest	Heat-treatment steel, high strength	1.7225 1.6580	42CrMo4 30CrNiMo8	950-1400	42CrMo4 30CrNiMo8
	Nitrierstahl, vergütet	Nitriding steel, heat treated	1.8504 1.2344	34CrAl6 X40CrMoV5.1	950-1400 -900	34CrAl6 X40CrMoV5-1
	Werkzeugstahl	Tool steel	1.2379	X155CrVMo12 1	-950	X153CrMoV12-1
			1.2316	X38CrMo16	-1100	X38CrMo16
			1.2080	X210Cr12	950-1400	X210Cr12
1.2312			40CrMnNiMoS8.6	-1150	40CrMnNiMoS8-6	
1.2343			X38CrMoV5 1	950-1400	X37CrMoV5-1	
1.2358			60CrMoV18-5	850-1000	60CrMoV18-5	
1.2714			55NiCrMoV7	1100-1350	55NiCrMoV7	
1.2311 1.2738			40CrMnMo7 45CrMnNiMo8.6.4	-1100 950-1150	40CrMnMo7 45CrMnNiMo8-6-4	
M	Rost- und säurebe- ständiger Stahl, austenitisch	Stainless steel, austenitic	1.4301	X2CrNiMo17-12-2	500-950	X5CrNiMo18-10
			1.4404	X6CrNiMoTi17-12-2		X2CrNiMo17-12-2
			1.4571	X10CrNiMoTi18		X10CrNiMoTi18
Rost- und säurebe- ständiger Stahl, martensitisch aushärtbar	Stainless steel, martensitic steel	1.2709	X3NiCoMoTi18-9-5	800-1000	X3NiCoMoTi18-9-5	
		1.4542	X5CrNiCuNb16-4		X5CrNiCuNb16-4	
		1.4568	X7CrNiAl17-7		X7CrNiAl17-7	
K	Grauguss	Grey cast iron	0.6025	GG25	100-400 (120-260 HB)	EN-GJL-250
			0.6678	GGL-NiCr35 2	150-250 (160-230 HB)	EN-GJLA-XNiCr35-2
	Sphäroguss	Nodular cast iron	0.7060	GGG60	400-800 (120-310 HB)	EN-GJS-600-3
			0.7070	GGG70L		EN-GJS-700-2U
Temperguss	Malleable cast iron	0.8155	GTS55	350-700 (150-280 HB)	EN-GJMB-550-4	
N	Aluminium-Legierungen, kurzspanend	Aluminium alloys, short chipping	3.2581	G-AlSi12	-400	G-IGK-AlSi12
	Aluminium-Legierungen, langspanend	Aluminium alloys, long chipping	3.3535	AlMg3	-550	AlMg3
			3.4365	AlZnMgCu1,5		AlZnMgCu1,5
	Kupfer-Legierungen, kurzspanend	Copper alloys, short chipping	2.0402	MS58	-500	CuZn40Pb2
	Kupfer-Legierungen, langspanend	Copper alloys, long chipping	2.0320	MS63	300-500	CuZn37
			2.0975	CuAl10Ni		CuAl10Fe5Ni5-C
Thermoplaste	Thermoplastics		PVC	40-70	PVC	
Duroplaste	Duroplastics		Bakelit, Melamin	20-40	Bakelit, Melamin	
S	Titan-Legierungen, mittelfest	Titanium alloys, medium strength	3.7115	TiAl5Sn2,5	-950	TiAl5Sn2-5
			3.7164	TiAl6V4		Ti6AlV4
	Titan-Legierungen, hochfest	Titanium alloys, high strength	3.7174	TiAl6Sn2	900-1400	TiAl6V6Sn2
	Nickelbasis-Legierungen, mittelfest	Nickel based alloys, medium strength	2.4670	NiCr12Al6MoNb	-950	NiCr12Al6MoNb
Nickelbasis-Legierungen, hochwarmfest	Heat resistant nickel based alloys, high strength	2.4668	NiCr19Fe19NbMo	900-1400	Inconel 718 NiCr19Fe19Nb5Mo3	
H	Hartguss	Chilled cast iron		Ni-hard, Ampco	300-600 HB	Ni-hard, Ampco
	Gehärteter Stahl	Hardened steel			45-52 HRC	
				53-59 HRC		
				60-65 HRC		

Die angegebenen Schnittwerte sind Startwerte und müssen auf die vorhandenen Bedingungen abgestimmt werden.
The cutting data indicated are starting values and must be adjusted to the prevailing conditions.

Schnittgeschwindigkeit Cutting speed v_c (m/min)								Schruppen Roughing			Schlichten Finishing		
								AR / AFR ¹⁾			AF / AFR ¹⁾		
LCP35M	LCM35M LCP40M	LCKP20M LCPK20M	LCPK30M LCPK28M	LCS40M LC225T	LCPK15M LCPK10M	LCH05M	LBHK85M (CBN)	f_z	a_p	a_e	f_z	a_p	a_e
165-180	180-200		160-170	160-180	150-250	200-320		0,50-1,00	0,50-3,00	66 %	0,20-0,80	0,30-0,80	max. 33 %
165-180	150-250	250-300	120-200	100-250	150-250	150-250		0,50-1,00	0,50-3,00		0,15-0,50	0,10-0,50	
	150-250	250-300	120-200	100-250	120-300	120-300		0,50-1,00	0,50-3,00		0,15-0,50	0,10-0,50	
	150-250	150-250	120-200	100-250	150-250	150-200		0,50-1,00	0,50-3,00		0,15-0,50	0,10-0,50	
	100-180	250-300	80-200	80-180	100-200	100-200		0,50-1,00	0,50-3,00		0,15-0,50	0,10-0,50	
	180-220	180-200	120-200	180-220	100-200	100-200		0,30-1,00	1,00-3,00		0,15-0,50	0,10-0,50	
	100-220	180-220	120-200	180-220	100-200	100-200		0,30-1,00	1,00-3,00		0,15-0,50	0,10-0,50	
	120-220	120-220	120-200	160-180	120-150	100-180		0,30-1,00	1,00-3,00		0,15-0,50	0,10-0,50	
	80-120		160-200					0,30-1,00	1,50-2,00	66 %	0,15-0,50	0,10-0,50	max. 33 %
	150-300		180-350								0,15-0,50	0,10-0,50	
		140-160	160-250		150-250	250-350	600-800	0,30-1,00	1,00-3,00	66 %	0,20-0,40	0,30-0,80	max. 33 %
		140-160	160-250		150-250	250-350	600-800	0,30-1,00	1,00-3,00		0,20-0,40	0,30-0,80	
		140-160	160-250		150-250	160-250	600-800	0,30-1,00	0,50-2,00		0,20-0,40	0,30-0,80	
		140-160	160-250		150-250	250-350	600-800	0,30-1,00	1,00-3,00		0,20-0,40	0,30-0,80	
200-400								0,20-1,00	0,50-4,00		0,10-0,60	0,10-0,50	max. 33 %
300-1200								0,20-1,00	0,50-4,00		0,10-0,60	0,10-0,50	
200-400								0,20-1,00	0,50-4,00		0,10-0,60	0,10-0,50	
300-1000								0,20-1,00	0,50-4,00		0,10-0,60	0,10-0,50	
300-1000								0,20-1,00	0,50-4,00		0,10-0,60	0,10-0,50	
200-4000								0,20-1,00	0,50-4,00		0,10-0,60	0,10-0,50	
					40-80			0,20-0,40	0,50-3,00		0,05-0,20	0,10-0,80	max. 33 %
				40-80				0,20-0,40	0,50-3,00		0,05-0,20	0,10-0,80	
				40-80				0,20-0,40	0,50-3,00		0,05-0,20	0,10-0,80	
				40-80				0,20-0,40	0,50-3,00		0,05-0,20	0,10-0,80	
		40-80				60-100	180-280				0,10-0,20	0,20-0,50	max. 33 %
				90-180		90-190					0,08-0,20	0,20-0,50	
				70-180		70-180					0,08-0,20	0,20-0,50	
						50-180	180-350				0,08-0,20	0,20-0,50	

¹⁾ AR / AFR / AF Erklärung siehe Seite 303
AR / AFR / AF Legend see page 303

Nanomold Beschichtungskonzept erleichtert die richtige Schneidstoffauswahl

Mit den Beschichtungsfarben schwarz – rot – gold erleichtert LMT Kieninger die richtige Auswahl der Frässorten im Gesenk- und Formenbau.

Nanomold Black:

Universal-Frässorte zum Nass- und Trockenfräsen von Stahl, rostfreien Stählen, Stahlguss, Grauguss und gehärtetem Stahl bis ca. 56 HRC.

Nanomold Red:

Hochleistungs-Beschichtung mit hoher Schneidkantenstabilität zur Feinbearbeitung von legierten und unlegierten Werkzeugstählen, hochfesten Werkstoffen und gehärtetem Stahl bis 65 HRC.

Nanomold Gold:

Hochverschleißfeste beschichtete Frässorte zum Schruppen und Semi-Schlichten von legierten und unlegierten Werkzeugstählen, hochfesten Werkstoffen und Grauguss.

Nanomold coating concept facilitates the choice of the right cutting grade.

By coating tools in black, red and gold, LMT Kieninger makes it easy to select the right milling grades in mold and die making.

Nanomold Black:

Universal milling grade for wet and dry milling of steel, stainless steel, cast steel, gray cast iron and hardened steel up to approx 56 HRC.

Nanomold Red:

High-performance coating with high cutting edge stability for the fine machining of alloyed and unalloyed tool steels, high-strength materials and hardened steel up to 65 HRC.

Nanomold Gold:

Highly abrasion resistant coated milling grade for roughing and semi-finishing of alloyed and unalloyed tool steels, high-strength materials and gray cast iron.

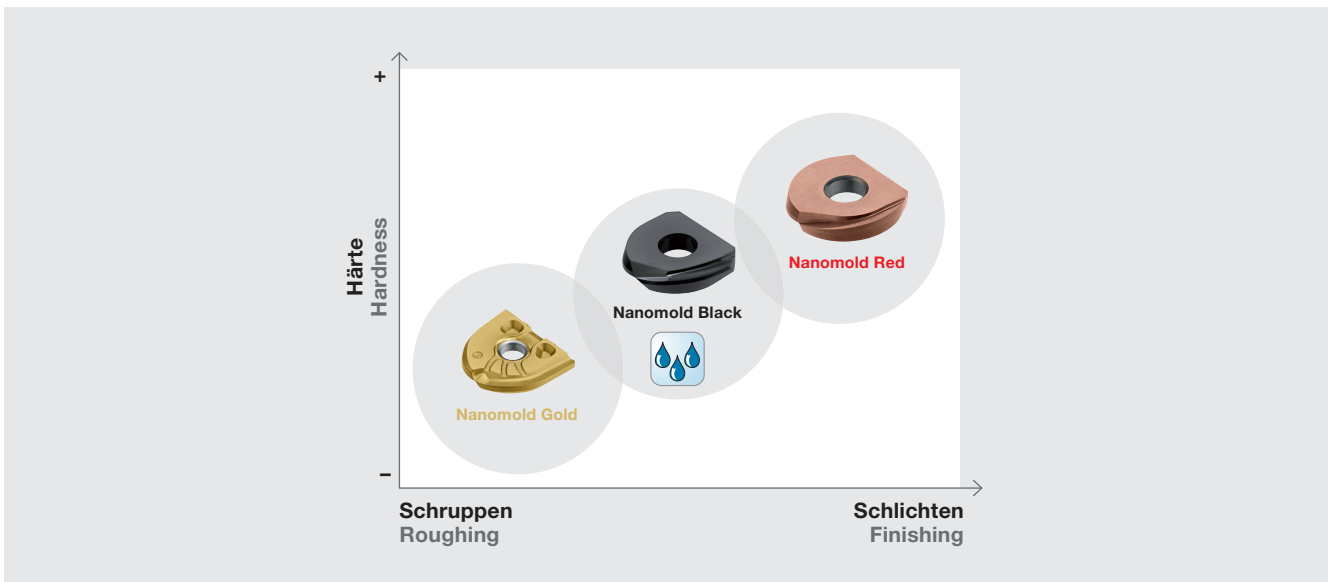

Erklärung der Wendeschneidplatten-Tabellen
Explanation of the cutting grade tables

Schneidstoffsorten Cutting materials Ident No.														
LWP40M	LWNS30M	LWNS10M	LWNS33M	LCP40M	LCPK30M	LCPK10M	LCPK25M	LCPK15M	LCKP10M	LCHK10M	LCH33M	LCN10M	LDN10M	Schneidstoffsorte Cutting material
unbeschichtet uncoated			Nanomold Gold			Nanomold Black		Nanomold Red				Beschichtungstyp Coating type		

FinishLine Premium – Der hochgenaue Fräser zum Vorschlichten und Schlichten The high precision cutter for semi-finishing and finishing

Das Universalfräsprogramm FinishLine Premium von LMT Kieninger zum Vorschlichten und Schlichten wurde komplett optimiert. Neu hinzugekommen ist eine Ausführung mit Zylinderschaft.

Dem Anwender steht nun ein Hochleistungsfrässystem zur Verfügung, mit dem Oberflächen in Schleifqualität erzeugt werden können.

Merkmale:

- Hochgenaues Werkzeug zum Vorschlichten und Schlichten sowohl im Gesenk- und Formenbau als auch im allgemeinen Maschinenbau
- Erhöhte Zähnezahlen im Vergleich zum bestehenden Programm
- Dadurch realisieren sich kürzere Fertigungszeiten bei gleicher Oberflächenqualität
- Deutlich stabileres Grundkörperdesign verbessert die Oberflächengeometrie und erhöht die Prozesssicherheit
- Fräser ab Ø 12 mm mit Zylinderschaft
- Wendeschneidplatten mit Wiper-Geometrie und neuer Hochleistungsbeschichtung Nanomold Red

FinishLine Premium, the universal milling product by LMT Kieninger for semi-finishing and finishing has been completely upgraded, with a cylindrical shank version added to the list of product.



The user can now put himself of a high performance milling system that allows him to reproduce ground quality surfaces.

Features:

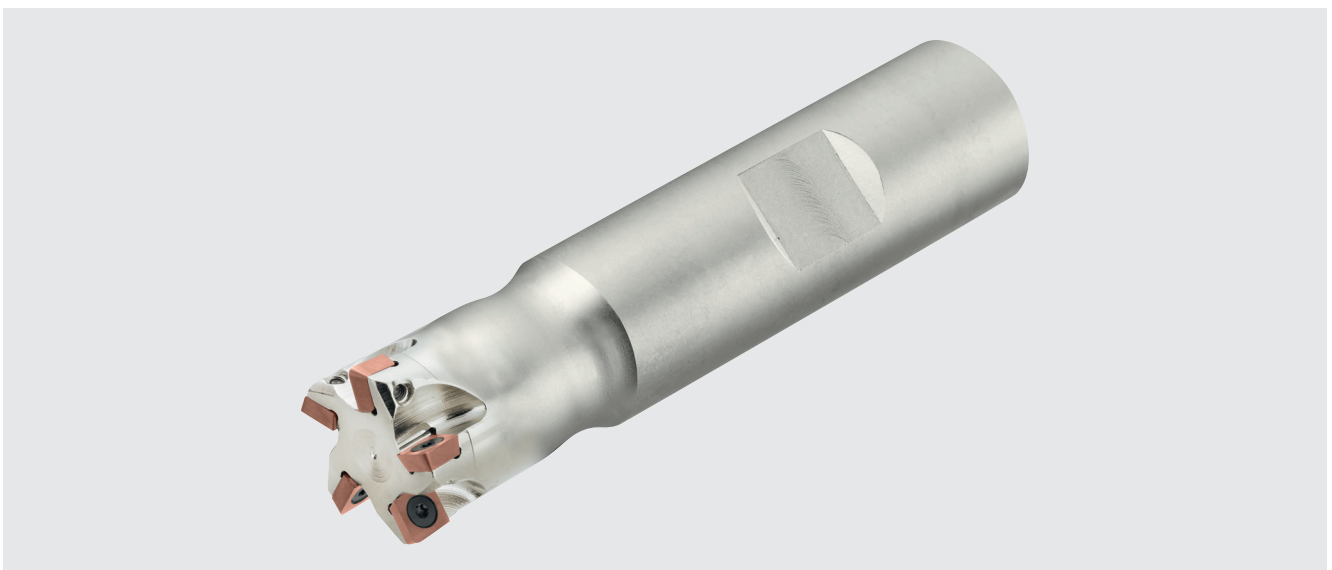
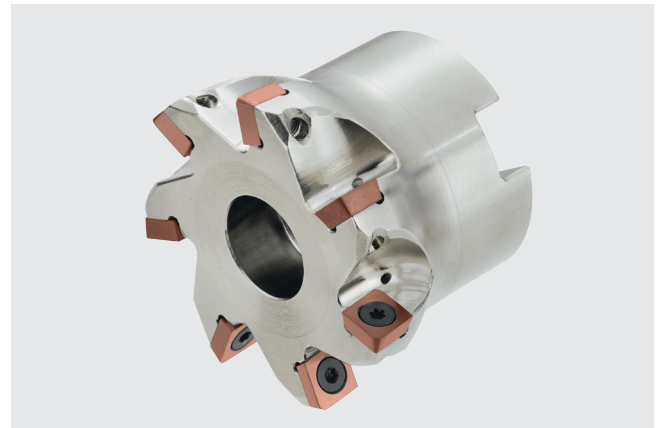
- High-precision tool for semi-finishing and finishing both in die and mold and in general machining
- Higher no. of teeth compared with the existing product range
- This means shorter manufacturing times while equal surface quality is achieved
- Significantly more stable main body design enables improved surface geometry and increased process reliability
- Cutters starting from Ø 12 mm with cylindrical shank
- Indexable inserts with wiper geometry and the new Nanomold Red high-performance coating

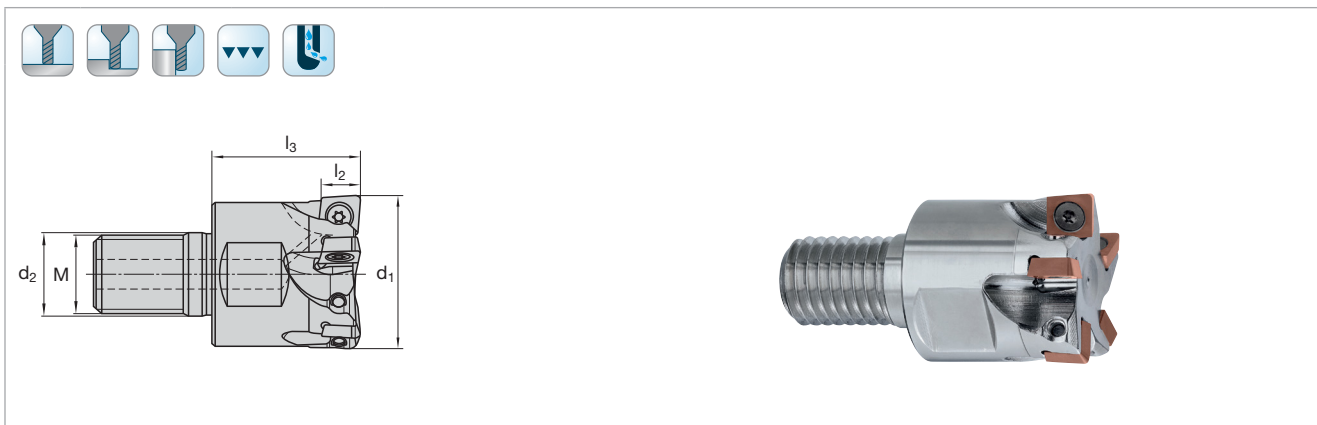

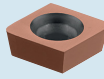

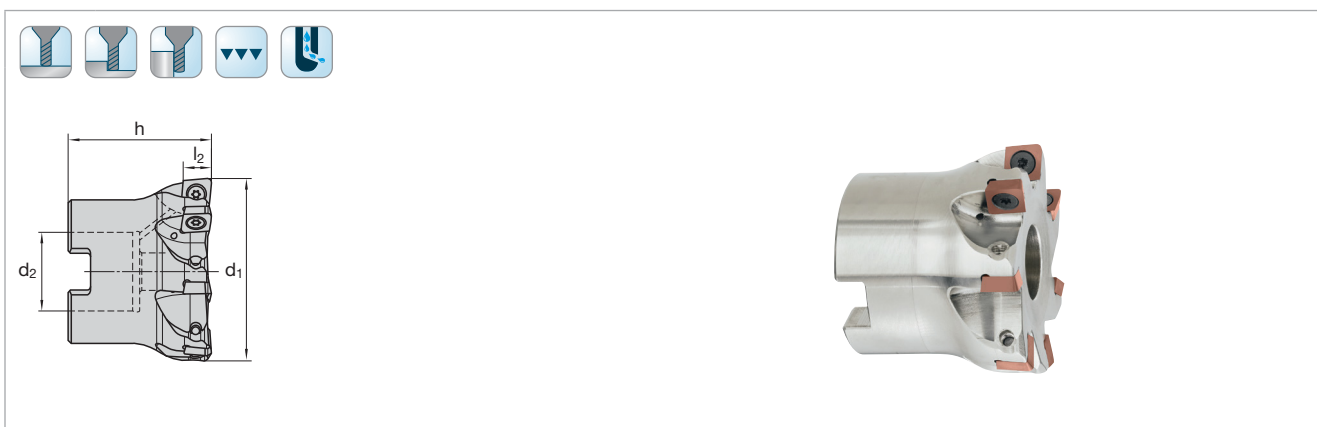

Katalog-Nr. Cat.-No.							ECG			
d ₁	l ₂	l ₃	d ₂	M	z	Ident No.	LMT-Code			
16	5	25	8,5	M8	3	7177787	ECG V05.016TR025-03-I	CPHX 050210	6119610	6119544 T6
20	5	25	10,5	M10	4	7177789	ECG V05.020TS025-04-I			
25	5	25	12,5	M12	5	7177791	ECG V05.025TF025-05-I			
20	8	25	10,5	M10	3	7114274	ECG V08.020TS025-03-I	CPHX 080310	6119613	6119528 T8
25	8	25	12,5	M12	4	7114275	ECG V08.025TF025-04-I			
32	8	30	16	M16	5	7114276	ECG V08.032TH030-05-I			
35	8	30	16	M16	5	7114277	ECG V08.035TH030-05-I			
40	8	30	16	M16	6	7114278	ECG V08.040TH030-06-I			

FinishLine Premium
Planfräskopf
Face milling cutters

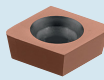

Katalog-Nr. Cat.-No.						FCG			
d ₁	l ₂	h	d ₂	z	Ident No.	LMT-Code			
42	8	40	16	6	7114279	FCG V08.042AN040-06-I	CPHX 080310	6119613	6119528 T8
52	8	40	22	7	7114280	FCG V08.052AN040-07-I			
66	8	50	27	9	7114281	FCG V08.066AN050-09-I			
80	8	50	27	11	7092880	FCG V08.080AN050-11-I			
100	8	55	32	13	7092881	FCG V08.100AN055-13-I			

Schnittwertempfehlungen ab Seite 318
Cutting data recommendations starting page 318

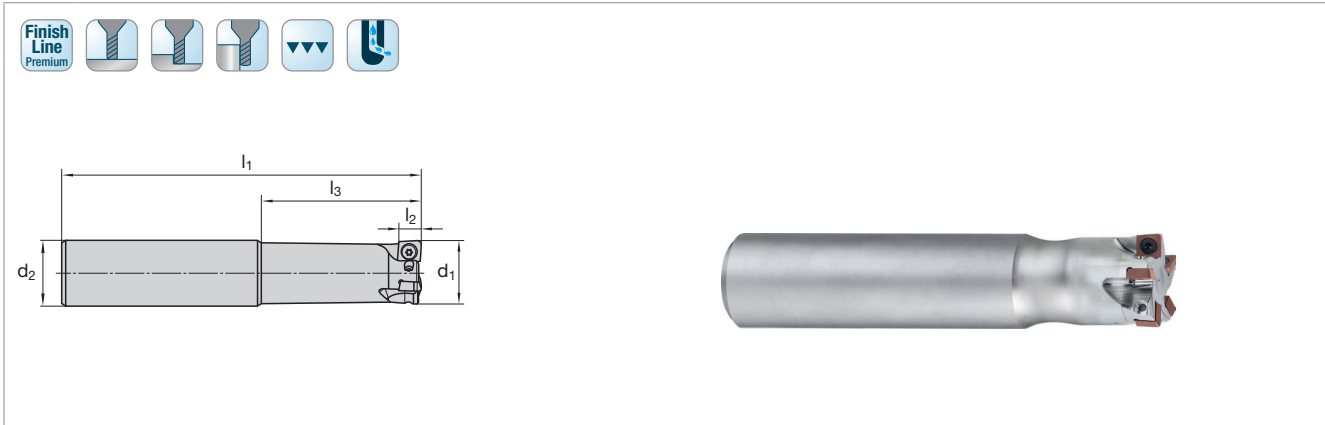

Katalog-Nr. Cat.-No.							ECG				
d ₁	l ₂	l ₁	l ₃	d ₂	z	Ident No.	LMT-Code				
12	5	77	32	12	2	7092882	ECG V05.012AN032-02-I	CPHX 050210	6119610	6119544 T6	
12	5	95	50	12	2	7092883	ECG V05.012AN050-02-I				
16	5	88	40	16	3	7092884	ECG V05.016AN040-03-I				
16	5	138	90	16	3	7092885	ECG V05.016AN090-03-I	CPHX 080310	6119613	6119528 T8	
20	8	110	60	20	3	7092886	ECG V08.020AN060-03-I				
20	8	170	120	20	3	7092887	ECG V08.020AN120-03-I				
25	8	146	90	25	4	7092888	ECG V08.025AN090-04-I				
25	8	216	160	25	4	7092889	ECG V08.025AN160-04-I				
32	8	150	90	32	5	7092890	ECG V08.032AN090-05-I				
32	8	220	160	32	5	7092891	ECG V08.032AN160-05-I				

Schnittwertempfehlungen ab Seite 318
Cutting data recommendations starting page 318

Wendeschneidplatten für FinishLine Premium Fräser
Indexable inserts for FinishLine Premium cutters

		Schneidstoffsorten Cutting materials										Für Fräser For cutter								
N = Anzahl der Schneidkanten N = Number of cutting edges		Ident No.											Cat-No.							
ISO-Code	l	d	s	d ₁	r	LWP40M	LWNS30M	LWNS10M	LWNS33M	LCP40M	LCPK30M	LCPK10M		LCPK25M	LCPK15M	LCKP10M	LCHK10M	LCH33M	LCN10M	
CPHX 050210	-	4,76	2,38	-	1										7093853					ECG FCG
CPHX 080310	-	7,93	3,18	-	1										7108610					

N = 2

■ = Hauptanwendung First choice
 □ = Nebenanwendung Alternative
 PKD & CBN bestückte Schneidplatten auf Anfrage
 PKD & CBN tipped inserts on request
 Sortenbeschreibung/-bezeichnung und ISO-Code ab Seite 424/477
 Description/designation of grades and ISO-Code starting page 424/477

Fräser mit Wendeschneidplatten
Milling with indexable inserts

FinishLine Premium
Schnittwertempfehlungen
Cutting data recommendations

	Werkstoff	Material	Werkstoff-Nr. Material No.	DIN Bezeichnung Alt DIN Description Old	R_m/UTS (N/mm²)	DIN Bezeichnung Neu DIN Description New	
P	Unlegierter Baustahl + Automatenstahl	Plain carbon steel + free cutting steel	1.0570	St52-3	-700	S355J2G3	
			1.1730	C45	-800	C45U	
			1.0715	9SMn28	-700	11SMn30	
			1.1191	Ck45	500-950	C45E	
			1.7219	26CrMo4			26CrMo4-2
	Vergütungsstahl, mittelfest	Heat-treatment steel, medium strength	1.7225	42CrMo4	500-950	42CrMo4	
			1.8159	51CrV4			51CrV4
	Stahlguss	Cast steel	1.0416	GS40	-950	GS40	
	Einsatzstahl	Case hardening steel	1.7131	16MnCr5	-950	16MnCr5	
	Rost- und säurebe- ständiger Stahl, ferritisch, martensitisch	Stainless steel, ferritic, martensitic	1.4006	X10Cr13	500-950	X12Cr13	
			1.4104	X12CrMoS17			X14CrMoS17
			1.4122	X35CrMo17			X39CrMo17-1
	Vergütungsstahl, hochfest	Heat-treatment steel, high strength	1.7225	42CrMo4	950-1400	42CrMo4	
			1.6580	30CrNiMo8			30CrNiMo8
	Nitrierstahl, vergütet	Nitriding steel, heat treated	1.8504	34CrAl6	950-1400	34CrAl6	
1.2344			X40CrMoV5.1	X40CrMoV5-1			
Werkzeugstahl	Tool steel	1.2343	X38CrMoV5 1	950-1400	X37CrMoV5-1		
		1.2379	X155CrVMo12 1			-950	X153CrMoV12-1
		1.2358	60CrMoV18-5	850-1000	60CrMoV18-5		
		1.2080	X210Cr12			950-1400	X210Cr12
		1.2714	55NiCrMoV7	1100-1350	55NiCrMoV7		
		1.2311	40CrMnMo7	-1100	40CrMnMo7		
		1.2312	40CrMnNiMoS8.6	-1150	40CrMnNiMoS8-6		
		1.2316	X38CrMo16	-1100	X38CrMo16		
1.2738	45CrMnNiMo8.6.4	950-1150	45CrMnNiMo8-6-4				
K	Grauguss	Grey cast iron	0.6025	GG25	100-400 (120-260 HB)	EN-GJI-250	
	Legierter Grauguss	Alloyed grey cast iron	0.6678	GGL-NiCr35 2	150-250 (160-230 HB)	EN-GJLA-XNiCr35-2	
	Sphäroguss	Nodular cast iron	0.7060	GGG60	400-800 (120-310 HB)	EN-GJS-600-3	
			0.7070	GGG70L		EN-GJS-700-2U	
Temperguss	Malleable cast iron	0.8155	GTS55	350-700 (150-280 HB)	EN-GJMB-550-4		
H	Hartguss	Chilled cast iron		Ni-hard, Ampco	300-600 HB	Ni-hard, Ampco	
	Gehärteter Stahl	Hardened steel			45-52 HRC		
					53-59 HRC		
					60-65 HRC		

Die angegebenen Schnittwerte sind Startwerte und müssen auf die vorhandenen Bedingungen abgestimmt werden.
The cutting data indicated are starting values and must be adjusted to the prevailing conditions.

	Schnittgeschwindigkeit Cutting speed v_c (m/min)	Vorschub pro Zahn Feed per tooth f_z (mm/z.)	
		a_p max	f_z max
LCKP10M	240-260	0,60	0,25
	240-280	0,60	0,25
	220-260	0,60	0,25
	280-300	0,60	0,25
	180-240	0,60	0,25
	220-260	0,60	0,25
	200-240	0,60	0,25
	200-250	0,60	0,20
	240-280	0,60	0,20
	220-240	0,60	0,20
	220-260	0,60	0,20
	220-260	0,60	0,20
	140-180	0,40	0,20
	180-220	0,40	0,20
	160-180	0,30	0,15
	100-120	0,25	0,15

Maße der FinishLine Premium Schlichtschneide in mm Wiper-dimension of FinishLine Premium in mm		
	CPHX 080310	CPHX 050210
radial	0,8	0,8
axial	0,5	0,5

Detailansicht
Detail view

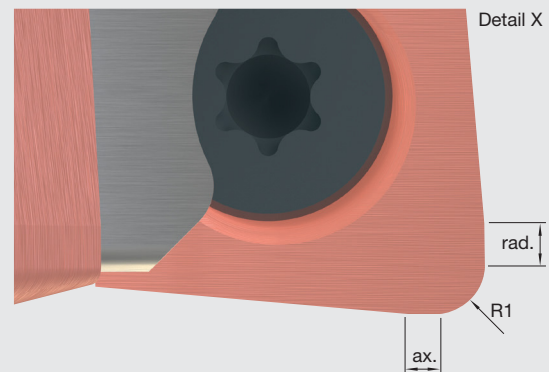
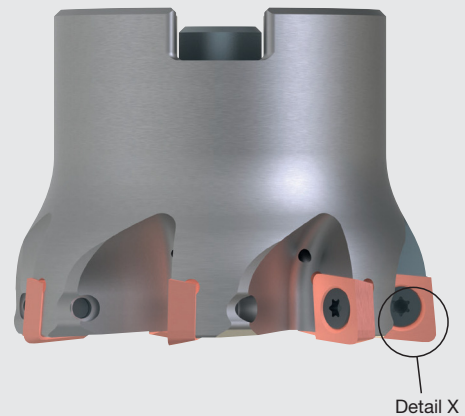

Wirtschaftlichkeit ist und bleibt ein wichtiger Erfolgsfaktor. Wenn dann noch eine bessere Performance hinzukommt, steigt das Einsparpotential deutlich an. Bei der neu entwickelten CopyMax Familie stehen diese zwei Faktoren im Vordergrund. Die Wirtschaftlichkeit durch den Herstellungsprozess HQS und höchste Leistungsfähigkeit im Gesenk- und Formenbau.

Doch damit nicht genug. Die Kopierfräsplatte selbst ist neu konstruiert. Neben verbesserten Schneid- und Materialeigenschaften verfügt der CopyMax2 über eine voll funktionsfähige zweite Schneide. Die Platte kann somit nach dem Verschleiß der ersten Schneide gedreht und noch einmal mit der gleich hohen Standzeit eingesetzt werden.

Für die Engineeringexperten bestand die Herausforderung darin, die zweite Schneide so in die Werkzeuggeometrie zu integrieren, dass der Anwender die Fräsplatte präzise, sicher und einfach in den Werkzeughalter montieren kann.

Das neue Werkzeugsystem CopyMax ist als Schaft- oder Aufschraubfräser in den Durchmessern 12, 16, 20, 25 und 32 mm verfügbar. Neu ist auch die Herstellung der Kopierfräsplatten mit dem Verfahren High-Quality-Sintering (HQS). Dabei werden durch einen erhöhten Prozessdruck und einer speziellen Formgebung noch stabilere Schneidkanten erzeugt. Sie wirken sich besonders beim Schruppen und Semischlichten von Großformen und bei der Restmaterialbeseitigung vorteilhaft aus und garantieren höchste Prozesssicherheit beim Zerspanen größerer Werkstückflächen.

Kundennutzen auf einen Blick

- Identische Geometrie zur höchst effizienten Kopierfräsplatte WPR-AR
- Stabile Schneidkante und bewährte Beschichtungen der Nanomold-Generation verdoppeln die Standzeit pro Schneide
- Je nach Anwendungsfall hat man die Wahl zwischen CopyMax1 und CopyMax2
- Höchst wirtschaftliche Lösung für 100 % ihrer Anwendungen in der Umformtechnik, Energietechnik und im Maschinenbau

Economy is and remains an important factor of success. If performance is added to this, the potential savings increase significantly. In the newly developed CopyMax family these two factors take center stage. Economy thanks to the HQS manufacturing process and maximum performance in mold and die making.

But it doesn't stop there. The copy insert itself features a new design. The CopyMax2 has improved cutting and material properties as well as a fully functional second cutting edge. When the first cutting edge is worn, the insert can be turned over and re-used with the same long tool life.

The challenge for the engineering experts was to integrate the second cutting edge into the tool geometry in such a way that the user would be able to mount the milling insert accurately, securely and easily in the tool holder.

The new CopyMax tool system is available as an end mill cutter or screw-on milling cutter in the diameters 12, 16, 20, 25 and 32 mm. Another new feature is that the copy milling insert is manufactured using the High Quality Sintering (HQS) process. With this process, even more stable cutting edges can be achieved thanks to the increased mold pressure and a special design. They are particularly beneficial for the roughing and semi-finishing of large molds as well for removing residual material and enable the machining of large workpiece surfaces with maximum process reliability.

Customer benefits at a glance

- Identical geometry to the highly efficient WPR-AR copy milling insert
- The stable cutting edge and proven Nanomold coatings double the tool life per cutting edge
- Depending on the application you can choose between CopyMax1 and CopyMax2
- Highly economic solution for 100 % of your applications in forming technology, energy technology and mechanical engineering





Katalog-Nr. Cat.-No.							CopyMax1				
d ₁	l ₂	l ₁	d ₃	d ₂	z	Ident No.	LMT-Code				
12	50	120	12	11	2	7254109	EBC R12.012AN 120-I	CMR 12 SR	GWS-D 12	15IP	
12	60	160	12	11	2	7254110	EBC R12.012AN 160-I				
16	55	140	16	14,5	2	7254111	EBC R16.016AN 140-I	CMR 16 SR/DR	GWS-D 16	20IP	
16	80	200	16	14,5	2	7254112	EBC R16.016AN 200-I				
20	60	140	20	18,5	2	7254113	EBC R20.020AN 140-I	CMR 20 SR/DR	GWS-D 20	20IP	
20	80	200	20	18,5	2	7254114	EBC R20.020AN 200-I				
25	75	140	25	23	2	7254115	EBC R25.025AN 140-I	CMR 25 SR/DR	GWS-D 25	25IP	
25	75	200	25	23	2	7254116	EBC R25.025AN 200-I				
32	70	140	32	29	2	7254119	EBC R32.032AN 140-I	CMR 32 DR	GWS-D 32	30IP	
32	90	220	32	29	2	7254120	EBC R32.032AN 220-I				

CopyMax®1
Kugel-Kopieraufschraubfräser
Ball nose screw-on type copy cutters

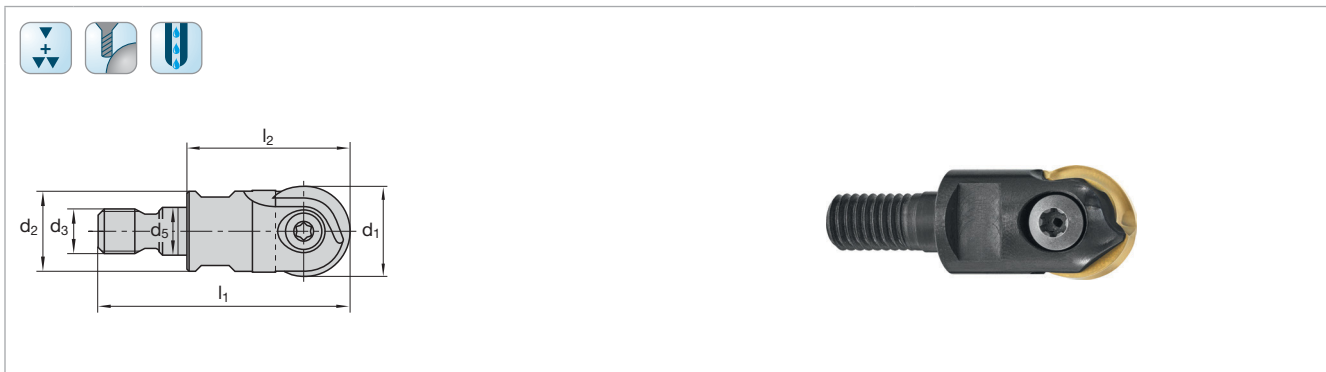

Katalog-Nr. Cat.-No.							CopyMax1				
d ₁	l ₂	l ₁	SW	d ₃	d ₅	d ₂	Ident No.	LMT-Code			
12	25	38	7	M6	6,5	10,8	7254127	EBC R12.012TC025-I	CMR 12 SR	GWS-D 12	15IP
16	26	43,5	10	M8	8,5	14,5	7254128	EBC R16.016TR026-I			
20	30	49,5	15	M10	10,5	18	7254129	EBC R20.020TS030-I	CMR 20 SR/DR	GWS-D 20	20IP
25	40	62	17	M12	12,5	23	7254130	EBC R25.025TF040-I			
32	45	69	24	M16	17	29	7254131	EBC R32.032TH045-I	CMR 32 DR	GWS-D 32	30IP

Schnittwertempfehlungen ab Seite 328
 Cutting data recommendations starting page 328

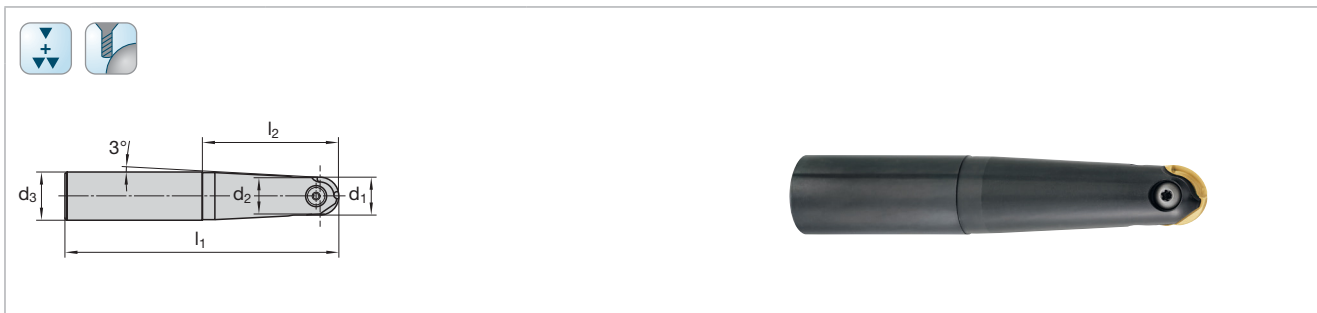

Katalog-Nr. Cat.-No.							CopyMax2				
d ₁	l ₂	l ₁	d ₃	d ₂	z	Ident No.	LMT-Code				
16	55	120	20	15,5	2	7142056	EBC R16.016AR120-D	CMR 16 DR/SR	GWS-D 16	20IP	
16	55	180	20	15,5	2	7177697	EBC R16.016AR180-D				
20	70	140	25	18,8	2	7168015	EBC R20.020AS140-D	CMR 20 DR/SR	GWS-D 20	25IP	
20	70	200	25	18,8	2	7177700	EBC R20.020AS200-D				
25	95	160	32	23,6	2	7168016	EBC R25.025AV160-D	CMR 25 DR/SR	GWS-D 25	25IP	
25	95	240	32	23,6	2	7177702	EBC R25.025AV240-D				

CopyMax®2
Kugel-Kopieraufschraubfräser
 Ball nose screw-on type copy cutters

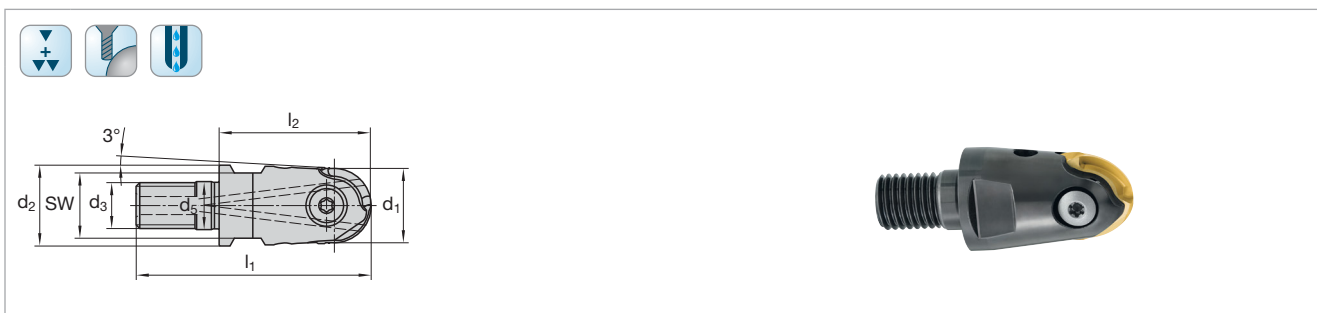

Katalog-Nr. Cat.-No.								CopyMax2				
d ₁	l ₂	l ₁	SW	d ₃	d ₅	d ₂	α	Ident No.	LMT-Code			
16	30	49,5	15	M10	10,5	18	3°	7169840	EBC R16.016TE030-I-D	CMR 16 DR/SR	GWS-D 16	20IP
20	40	62	17	M12	12,5	21	3°	7177699	EBC R20.020TF040-I-D			
25	45	69	24	M16	17	29	5°	7177701	EBC R25.025TH045-I-D	CMR 25 DR/SR	GWS-D 20	25IP

Schnittwertempfehlungen ab Seite 328
 Cutting data recommendations starting page 328

		Schneidstoffsorten Cutting materials											Für Fräser For cutter										
		Ident No.																					
N = Anzahl der Schneidkanten N = Number of cutting edges	ISO-Code	l	d	s	d ₁	r	LWP40M	LWNS30M	LWNS10M	LWNS33M	LCP40M	LCPK30M	LCPK10M	LCPK25M	LCPK15M	LCKP10M	LCHK10M	LCMS35M	LCN10M	LDN10M	Cat-No.		
 N = 2	CMR 16 DR	18	16	3	5,2	8		7167186				7167561										EBC R 16	
	CMR 20 DR	23	20	4	5,7	10		7167187				7167562										EBC R 20	
	CMR 25 DR	28	25	5	6,2	12,5		7167188				7167563										EBC R 25	
	CMR 32 DR	35	32	6	8,9	16		7189771				7189772										EBC R 32	
											■											P	
																							M
											□												K
											■												N
											□												S
																							H

■ = Hauptanwendung First choice
 □ = Nebenanwendung Alternative
 Sortenbeschreibung/-bezeichnung und ISO-Code ab Seite 424/477
 Description/designation of grades and ISO-Code starting page 424/477

CopyMax®
Schrauben und Torx-Schraubendreher
Screws and wrenches

LMT-Code	Torx	SW	Ident No.	Schraubendreher Wrenches	Torx	M _A	Quergriff + Klinge Cross handle + blade Ident No.	Quergriff Cross handle	Ident No.	Klinge Blade	Ident No.
GWS-D 12	15IP	2	7245402	15IP	15IP	5 Nm	7247494	SW6	7188878	15IP	7247495
GWS-D 16	20IP	2,5	7146468	20IP	20IP	6 Nm	7188874			20IP	7188876
GWS-D 20			7168007								
GWS-D 25	25IP	3,0	7168008	25IP	25IP	8 Nm	7188875			25IP	7188877
GWS-D 32	30IP	3,0	7189758	30IP	30IP	10 Nm	7230276			30IP	7230277

M_A: maximales Anzugsmoment max. Torque

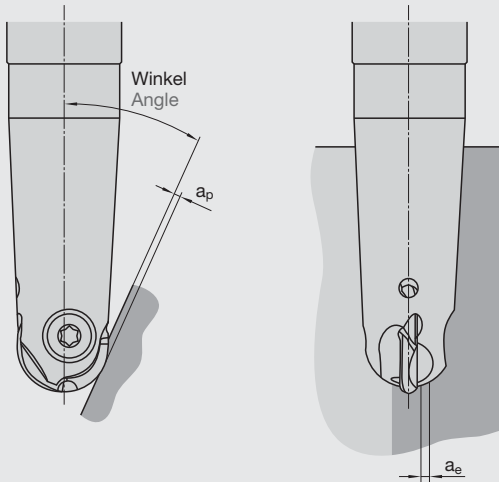

CMR 20 DR

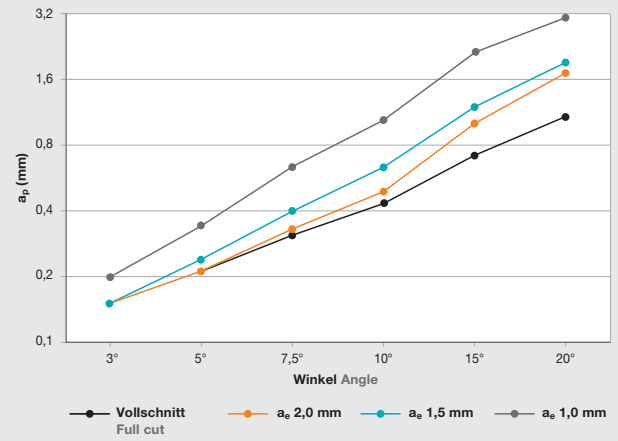

CMR 16 DR

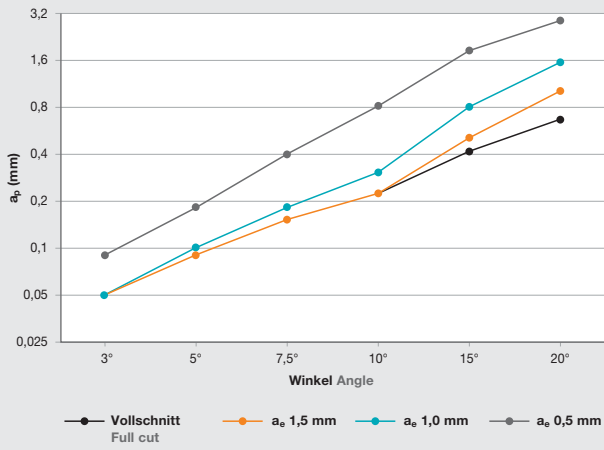

CMR 25 DR

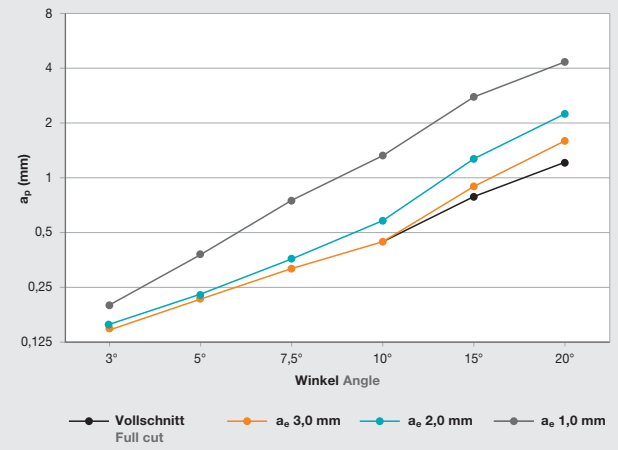

Die Montage und Demontage der CopyMax®-Wendeplatte zum Schneidenwechsel ist sehr bedienerfreundlich, wie die folgende Kurzanleitung zeigt.

Assembly and disassembly of the CopyMax® insert to change cutting edges is very user-friendly as shown in the operating instructions.

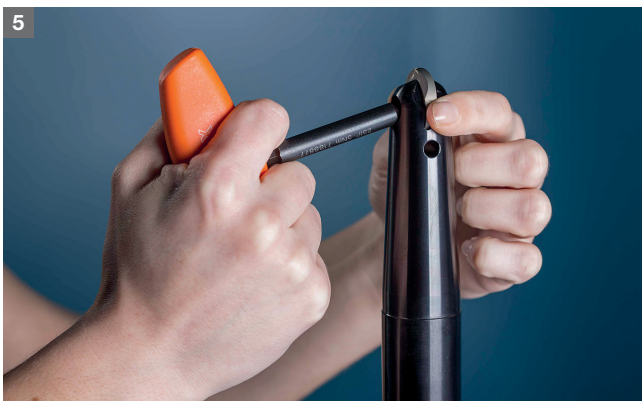

1. Montage der CopyMax®-Wendeplatte mit der ersten Seite nach oben. Die Zahl (1 oder 2) auf der Wendeplatte sollte dabei immer Richtung Schraubensenkung zeigen.
2. Alle wichtigen Informationen (Drehmoment, Torx, Schraube) sind auf dem Fräshalter eingraviert.
3. Anziehen der Schraube mit einem Drehmomentschlüssel.
4. Öffnen der Schraube mit dem CopyMax®-Griffschlüssel.
5. Lösen der Wendeplatte mit dem eigens dafür entwickelten CopyMax®-Griffschlüssel.
6. Erneute Montage der Wendeplatte, diesmal mit der zweiten Seite nach oben.

1. Assembly of the CopyMax® insert with the first side up. The number (1 or 2) on the insert should always point in the direction of the screw countersink.
2. All relevant information (torque, Torx, screw) is engraved on the cutter body.
3. Tighten the screw with a torque wrench.
4. Open the screw with the CopyMax® wrench.
5. Release the insert with the specifically developed CopyMax® wrench.
6. Repeat assembly of the insert, this time with the second side up.

Optimal wird der CopyMax® unter folgenden Maschinenbedingungen eingesetzt:

- Fräsen mit Z-konstant
- Fräsen angestellt 3+2
- Fräsen 5-Achs simultan

Ideally, the CopyMax® is used under the following machine conditions:

- Milling with Z constant
- Milling engaged 3+2
- Simultaneous 5-axis milling

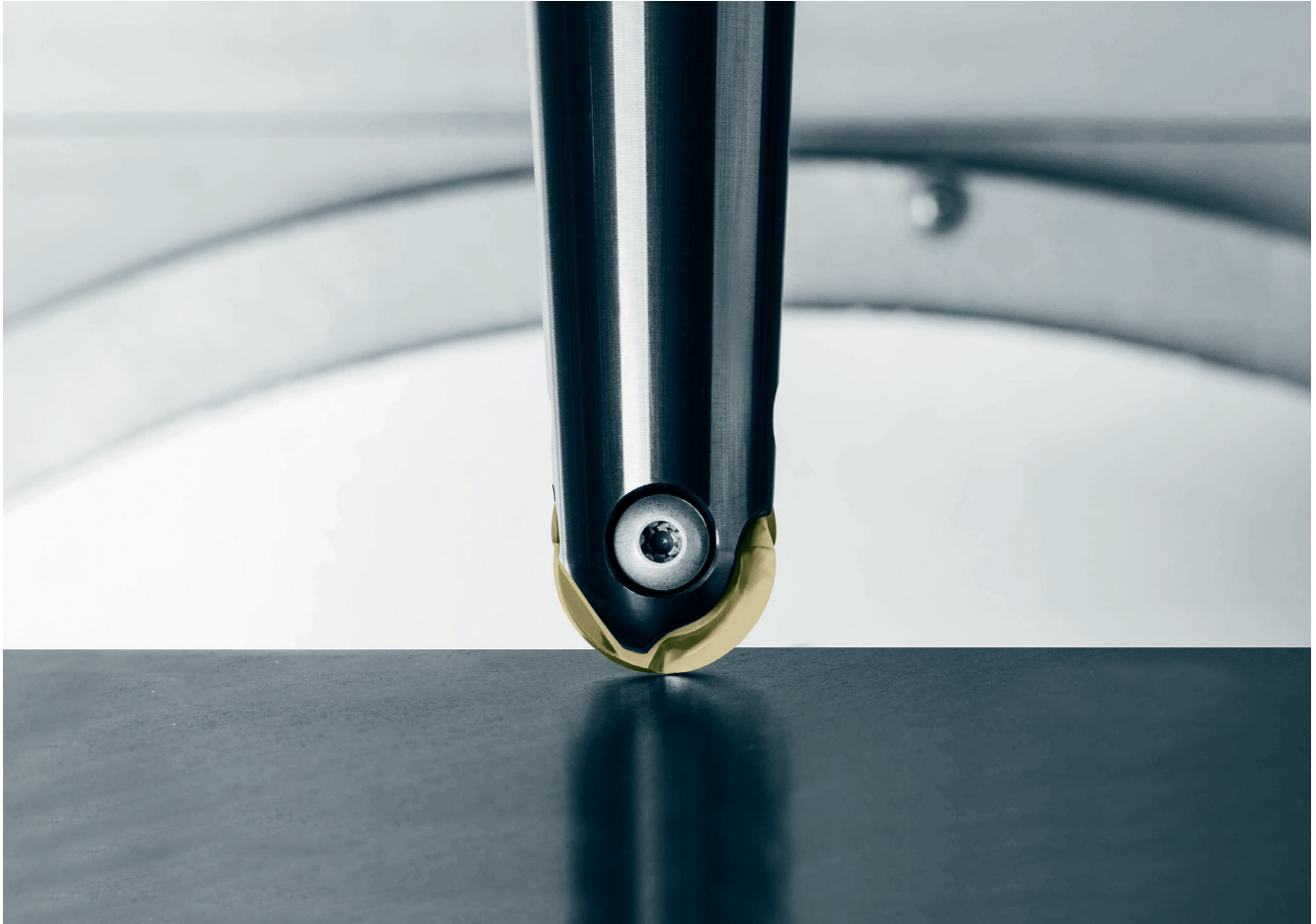

Schnittwertempfehlungen für Wechsellplatte CMR-.. Schruppen

Cutting data recommendations for indexable insert CMR-.. Roughing

	Werkstoff	Material	Werkstoff-Nr. Material No.	DIN Bezeichnung Alt DIN Description Old	R _m /UTS (N/mm ²)	DIN Bezeichnung Neu DIN Description New				
P	Unlegierter Baustahl + Automatenstahl	Plain carbon steel + free cutting steel	1.0570	St52-3	-700	S355J2G3				
			1.1730	C45	-800	C45U				
			1.0715	9SMn28	-700	11SMn30				
			1.1191 1.7219	Ck45 26CrMo4	500-950	C45E 26CrMo4-2				
	Vergütungsstahl, mittelfest	Heat-treatment steel, medium strength	1.7225 1.8159	42CrMo4 51CrV4	500-950	42CrMo4 51CrV4				
	Stahlguss	Cast steel	1.0416	GS40	-950	GS40				
	Einsatzstahl	Case hardening steel	1.7131	16MnCr5	-950	16MnCr5				
	Rost- und säurebe- ständiger Stahl, ferritisch, martensitisch	Stainless steel, ferritic, martensitic	1.4006	X10Cr13	500-950	X12Cr13				
			1.4104 1.4122	X12CrMoS17 X35CrMo17		X14CrMoS17 X39CrMo17-1				
			1.7225 1.6580	42CrMo4 30CrNiMo8	950-1400	42CrMo4 30CrNiMo8				
	Vergütungsstahl, hochfest	Heat-treatment steel, high strength	1.8504 1.2344	34CrAl6 X40CrMoV5.1	950-1400 -900	34CrAl6 X40CrMoV5-1				
	Nitrierstahl, vergütet	Nitriding steel, heat treated	1.2343 1.2379	X38CrMoV5 1 X155CrVMo12 1	950-1400 -950	X37CrMoV5-1 X153CrMoV12-1				
	Werkzeugstahl	Tool steel	1.2358	60CrMoV18-5	850-1000	60CrMoV18-5				
			1.2080	X210Cr12	950-1400	X210Cr12				
1.2714			55NiCrMoV7	1100-1350	55NiCrMoV7					
1.2311			40CrMnMo7	-1100	40CrMnMo7					
1.2312			40CrMnNiMoS8.6	-1150	40CrMnNiMoS8-6					
1.2316			X38CrMo16	-1100	X38CrMo16					
1.2738			45CrMnNiMo8.6.4	950-1150	45CrMnNiMo8-6-4					
M	Rost- und säurebe- ständiger Stahl, austenitisch	Stainless steel, austenitic	1.4301	X2CrNiMo17-12-2	500-950	X5CrNiMo18-10				
			1.4404 1.4571	X6CrNiMoTi17-12-2 X10CrNiMoTi18		X2CrNiMo17-12-2 X10CrNiMoTi18				
			1.2709 1.4542 1.4568	X3NiCoMoTi18-9-5 X5CrNiCuNb16-4 X7CrNiAl17-7	800-1000	X3NiCoMoTi18-9-5 X5CrNiCuNb16-4 X7CrNiAl17-7				
K	Grauguss	Grey cast iron	0.6025	GG25	100-400 (120-260 HB)	EN-GJI-250				
			Legierter Grauguss	Alloyed grey cast iron	0.6678	GGL-NiCr35 2	150-250 (160-230 HB)	EN-GJLA-XNiCr35-2		
					Sphäroguss	Nodular cast iron	0.7060 0.7070	GGG60 GGG70L	400-800 (120-310 HB)	EN-GJS-600-3 EN-GJS-700-2U
							Temperguss	Malleable cast iron	0.8155	GTS55
N	Aluminium-Legierungen, kurzspanend	Aluminium alloys, short chipping	3.2581	G-AlSi12	-400	G-IGK-AISi12				
			3.3535 3.4365	AlMg3 AlZnMgCu1,5	-550	AlMg3 AlZnMgCu1,5				
	Kupfer-Legierungen, kurzspanend	Copper alloys, short chipping	2.0402	MS58	-500	CuZn40Pb2				
			2.0320 2.0975	MS63 CuAl10Ni	300-500	CuZn37 CuAl10Fe5Ni5-C				
	Thermoplaste	Thermoplastics		PVC	40-70	PVC				
	Duroplaste	Duroplastics		Bakelit, Melamin	20-40	Bakelit, Melamin				
	Graphit	Graphite								
	Zirkonoxidkeramik	Zircon oxide ceramics								
S	Titan-Legierungen, mittelfest	Titanium alloys, medium strength	3.7115 3.7164	TiAl5Sn2,5 TiAl6V4	-950	TiAl5Sn2-5 TiAl6V4				
			3.7174	TiAl6Sn2	900-1400	TiAl6V6Sn2				
	Nickelbasis-Legierungen, mittelfest	Nickel based alloys, medium strength	2.4670	NiCr12Al6MoNb	-950	NiCr12Al6MoNb				
	Nickelbasis-Legierungen, hochwarmfest	Heat resistant nickel based alloys, high strength	2.4668	NiCr19Fe19NbMo	900-1400	Inconel 718 NiCr19Fe19Nb5Mo3				
	Kobalt-Chrom-Legierung	Cobalt chromium alloys								
H	Hartguss	Chilled cast iron		Ni-hard, Ampco	300-600 HB	Ni-hard, Ampco				
			Gehärteter Stahl	Hardened steel		45-52 HRC				
						53-59 HRC				
				60-65 HRC						

¹⁾ Bitte bei ziehendem Schnitt die Einsatzhinweise auf Seite 325 beachten.





Die angegebenen Schnittwerte sind Startwerte und müssen auf die vorhandenen Bedingungen abgestimmt werden.

Schnittgeschwindigkeit Cutting speed v_c (m/min)				Vorschub pro Zahn Feed per tooth f_z (mm/z.)					a_e Schruppen Roughing
				$\varnothing 12$	$\varnothing 16$	$\varnothing 20$	$\varnothing 25$	$\varnothing 32$	
LCPK30M	LCPK25M	LCMS35M	LWNS30M	$a_p \max^{1)} f_z \max$	$a_p \max^{1)} f_z \max$	$a_p \max^{1)} f_z \max$	$a_p \max^{1)} f_z \max$	$a_p \max^{1)} f_z \max$	
160-180	160-180			3,0 0,25	4,0 0,35	5,0 0,40	6,00 0,45	8,0 0,50	d x 0,10-0,12
160-180	160-180			3,0 0,25	4,0 0,35	5,0 0,40	6,0 0,45	8,0 0,50	
140-160	140-160			3,0 0,25	4,0 0,35	5,0 0,40	6,0 0,45	8,0 0,50	
140-160	140-160			3,0 0,25	4,0 0,35	5,0 0,40	6,0 0,45	8,0 0,50	
120-140	120-140			3,0 0,25	4,0 0,30	5,0 0,35	6,0 0,40	8,0 0,45	
140-160	140-160			3,0 0,25	4,0 0,30	5,0 0,35	6,0 0,40	8,0 0,45	
160-180	160-180			3,0 0,25	4,0 0,35	5,0 0,40	6,0 0,45	8,0 0,50	
160-200	160-200			3,0 0,25	4,0 0,35	5,0 0,40	6,0 0,45	8,0 0,50	
		120-140	120-140	2,50 0,20	3,0 0,30	4,0 0,35	5,0 0,40	6,0 0,45	d x 0,08-0,10
		100-120	100-120	2,50 0,20	3,0 0,30	4,0 0,35	5,0 0,40	6,0 0,45	
120-140	120-140			4,0 0,25	5,0 0,35	6,0 0,40	8,0 0,45	10,0 0,50	d x 0,10-0,12
120-140	120-140			4,0 0,25	5,0 0,35	6,0 0,40	8,0 0,45	10,0 0,50	
180-200	180-200			4,0 0,25	5,0 0,35	6,0 0,40	8,0 0,45	10,0 0,50	
160-180	160-180			4,0 0,25	5,0 0,35	6,0 0,40	8,0 0,45	10,0 0,50	
			250-300	4,0 0,25	5,0 0,35	6,0 0,40	8,0 0,45	10,0 0,50	d x 0,10-0,12
			250-300	4,0 0,25	5,0 0,35	6,0 0,40	8,0 0,45	10,0 0,50	
			250-300	4,0 0,25	5,0 0,35	6,0 0,40	8,0 0,45	10,0 0,50	
			200-250	4,0 0,25	5,0 0,35	6,0 0,40	8,0 0,45	10,0 0,50	
			200-250	4,0 0,25	5,0 0,35	6,0 0,40	8,0 0,45	10,0 0,50	
			200-250	4,0 0,25	5,0 0,35	6,0 0,40	8,0 0,45	10,0 0,50	
		100-120	80-100	1,5-2,0 0,25	2,5-3,0 0,35	3,0-3,5 0,40	3,0-4,0 0,45	4,0 0,50	d x 0,08-0,10
		60-100	60-80	1,5-2,0 0,25	2,5-3,0 0,35	3,0-3,5 0,40	3,0-4,0 0,45	4,0 0,50	
		60-100	60-80	1,5-2,0 0,25	2,5-3,0 0,35	3,0-3,5 0,40	3,0-4,0 0,45	4,0 0,50	
		60-18	40-60	1,5-2,0 0,25	2,5-3,0 0,35	3,0-3,5 0,40	3,0-4,0 0,45	4,0 0,50	

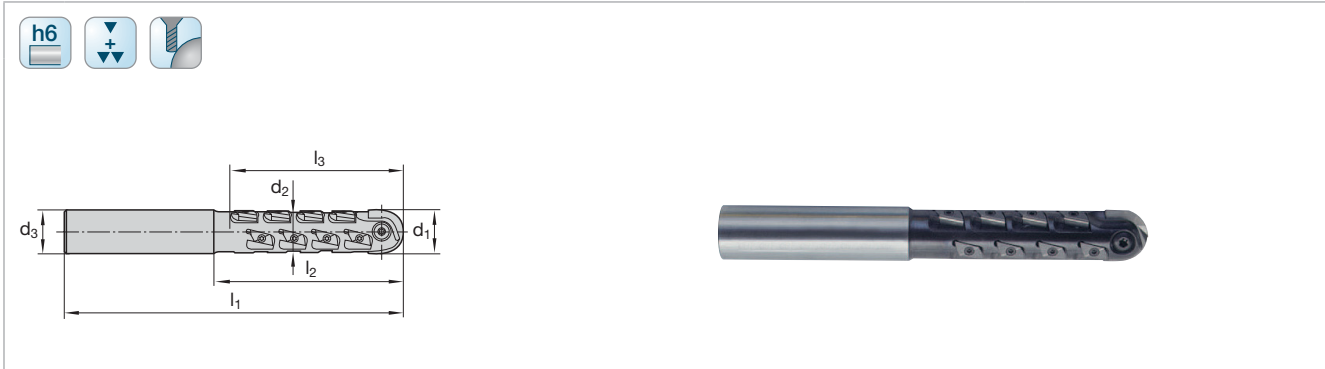



¹⁾ In case of a climbing cut please mind the references at page 325.

The cutting data indicated are starting values and must be adjusted to the prevailing conditions.

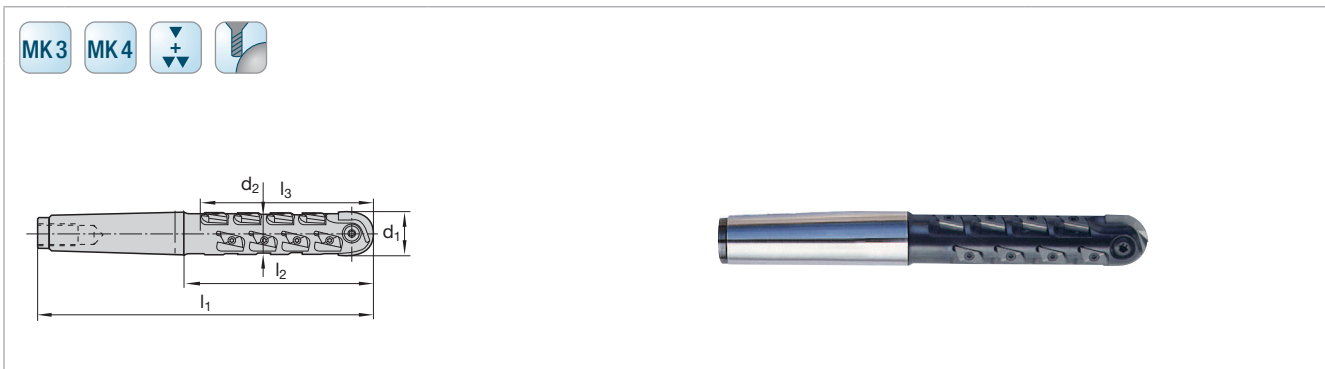

Katalog-Nr. Cat.-No.								GRT					
d ₁	l ₂	l ₁	l ₃	d ₃	d ₂	z	Ident No.	LMT-Code		 ¹⁾		 ¹⁾	
25	100	190	80	25	23	2	6121224	EBG T25.025AN190-080	WPR AS 25	GWS 25	5 x WPS-A	SA	T30 ²⁾
25	140	230	120	25	23	2	6121223	EBG T25.025AN230-120			9 x WPS-A		T15 ³⁾
32	100	210	80	32	29	2	6121227	EBG T32.032AN210-080	WPR AS 32	GWS 32	10 x WPS-A	SA	T15 ³⁾
32	140	250	120	32	29	2	6121226	EBG T32.032AN250-120			16 x WPS-A		



Katalog-Nr. Cat.-No.								GRT					
d ₁	l ₂	l ₁	l ₃	d ₂	MK	z	Ident No.	LMT-Code		 ¹⁾		 ¹⁾	
25	100	190	80	23	3	2	6121214	EBG T25.025M3170-080	WPR AS 25	GWS 25	5 x WPS-A	SA	T30 ²⁾
25	140	230	120	23	3	2	6121213	EBG T25.025M3230-120			9 x WPS-A		T15 ³⁾
32	100	210	80	29	4	2	6121217	EBG T32.032M4210-080	WPR AS 32	GWS 32	10 x WPS-A	SA	T15 ³⁾
32	140	250	120	29	4	2	6121216	EBG T32.032M4250-120			16 x WPS-A		

¹⁾ Anzugsmoment siehe Tabelle Seite 345
 Torque see overview page 345

Schnittwertempfehlungen ab Seite 336
 Cutting data recommendations starting page 336

²⁾ Schraubendreher T30 für Schraube GWS 25 und GWS 32
 Screwdriver T30 for screw GWS 25 and GWS 32

³⁾ Schraubendreher T15 für Schraube SA 40 115
 Screwdriver T15 for screw SA 40 115

Drehmomentschlüssel auf Anfrage
 Torque spanner on request

Ident No. Schrauben und Torx-Schraubendreher siehe Seite 369
 Ident No. Screws and wrenches see page 369

GRT
Kugel-Kopierschruppfräser
 Ball nose copy roughing cutters

Katalog-Nr. Cat.-No.										GRT					
d ₁	l ₂	l ₁	l ₃	l ₄	d ₃	d ₂	z	Ident No.	LMT-Code		¹⁾		¹⁾	²⁾	
25	70	190	46	70	25	23	2	6121222	EBG T25.025AN190	WPR/WRT... 25	GWS 25	2 x WPT-A	SA	T30 ²⁾	
32	80	210	49	80	32	29	2	6121225	EBG T32.032AN210	WPR/WRT... 32	GWS 32	4 x WPT-A	40 115	T15 ³⁾	

GRT
Kugel-Kopierschruppfräser
 Ball nose copy roughing cutters

Katalog-Nr. Cat.-No.										GRT					
d ₁	l ₂	l ₁	l ₃	l ₄	d ₃	MK	z	Ident No.	LMT-Code		¹⁾		¹⁾	²⁾	
25	70	170	46	70	23	3	2	6121212	EBG T25.025M3170	WPR/WRT... 25	GWS 25	2 x WPT-A	SA	T30 ²⁾	
32	70	190	49	70	29	4	2	6121215	EBG T32.032M4190	WPR/WRT... 32	GWS 32	4 x WPT-A	40 115	T15 ³⁾	

¹⁾ Anzugsmoment siehe Tabelle Seite 345
 Torque see overview page 345

²⁾ Schraubendreher T30 für Schraube GWS 25 und GWS 32
 Screwdriver T30 for screw GWS 25 and GWS 32

³⁾ Schraubendreher T15 für Schraube SA 40 115
 Screwdriver T15 for screw SA 40 115

Drehmomentschlüssel auf Anfrage
 Torque spanner on request

Ident No. Schrauben und Torx-Schraubendreher siehe Seite 369
 Ident No. Screws and wrenches see page 369

Schnittwertempfehlungen ab Seite 336
 Cutting data recommendations starting page 336

 N = Anzahl der Schneidkanten N = Number of cutting edges		Schneidstoffsorten Cutting materials Ident No.											Für Fräser For cutter Cat-No.																															
		ISO-Code	l	d	s	d ₁	r	LWP40M	LCP40M	LWNS30M	LCPK30M	LCHK30M		LWNS10M	LCPK10M	LCKP10M	LCHK10M	LCN10M	LWNS33M	LCH33M	LBHK95M	LDN10M																						
 N = 2	WRT 25	-	25	4	6	-	6200211							6122402									P																					
	WRT 32	-	32	5	8	-	6200213							6122387									M																					
																								K																				
																																											N	
																																												S
																																												H

■ = Hauptanwendung First choice
 □ = Nebenanwendung Alternative
 Sortenbeschreibung/-bezeichnung und ISO-Code ab Seite 424/477
 Description/Designation of grades and ISO-Code starting page 424/477

GRT μ-jet
Schneidplatten für Kugel-Kopierschruppfräser
Copy inserts for ball nose copy roughing cutters

 N = Anzahl der Schneidkanten N = Number of cutting edges		Schneidstoffsorten Cutting materials Ident No.											Für Fräser For cutter Cat-No.																																
		ISO-Code	l	d	s	d ₁	r	LWP40M	LCP40M	LWNS30M	LCPK30M	LCHK30M		LWNS10M	LCPK10M	LCKP10M	LCHK10M	LCN10M	LWNS33M	LCH33M	LBHK95M	LDN10M																							
 N = 2	WPR 25 AR	-	25	4	6	12,5				6183218	9080645													P																					
	WPR 32 AR	-	32	5	8	16				9074078	7016820													M																					
																									K																				
																									N																				
																																												S	
																																													H

■ = Hauptanwendung First choice
 □ = Nebenanwendung Alternative
 Sortenbeschreibung/-bezeichnung und ISO-Code ab Seite 424/477
 Description/Designation of grades and ISO-Code starting page 424/477
 Alle WPR-, WPV- und WPB-Wendepplatten sind in der Sorte LCN10M (diamantbeschichtet) oder PKD/CBN-bestückt auf Anfrage lieferbar.
 All WPR, WPV and WPB inserts are available in grade LCN10M (diamond coated) or PCD/CBN tipped.

							Schneidstoffsorten Cutting materials											Für Fräser For cutter								
							Ident No.												Cat-No.							
N = Anzahl der Schneidkanten N = Number of cutting edges	ISO-Code	l	d	s	d ₁	r	LWP40M	LCP40M	LWNS30M	LCPK30M	LCHK30M	LWNS10M	LCPK10M	LCKP10M	LCHK10M	LCN10M	LWNS33M	LCH33M		LBHK95M	LDN10M					
 N = 2	WPT A	6	12	4	-	-	6122414						6122418	6122419								EBG T ..				
■ = Hauptanwendung First choice □ = Nebenanwendung Alternative Sortenbeschreibung/-bezeichnung und ISO-Code ab Seite 424/477 Description/Designation of grades and ISO-Code starting page 424/477																										
																							P			
																								M		
																								K		
																								N		
																								S		
																								H		

		Schneidstoffsorten Cutting materials											Für Fräser For cutter													
		Ident No.																								
N = Anzahl der Schneidkanten N = Number of cutting edges	ISO-Code	l	d	s	d ₁	r	LWP40M	LCP40M	LWNS30M	LCPK30M	LCHK30M	LWNS10M	LCPK10M	LCKP10M	LCHK10M	LCN10M	LWNS33M	LCH33M	LBHK95M	LDN10M	Cat-No.					
	WPR 25 AS	-	25	4	6	12,5			9120404												EBG R 25 EBG R 32					
	WPR 32 AS	-	32	5	8	16			9120405																	
N = 2																										
	WPS A	6	12	4	-	-						6122405										EBG T ..				
N = 2																										
■ = Hauptanwendung First choice □ = Nebenanwendung Alternative Sortenbeschreibung/-bezeichnung und ISO-Code ab Seite 424/477 Description/Designation of grades and ISO-Code starting page 424/477 Alle WPR-, WPV- und WPB-Wendepplatten sind in der Sorte LCN10M (diamantbeschichtet) oder PKD/CBN-bestückt auf Anfrage lieferbar. All WPR, WPV and WPB inserts are available in grade LCN10M (diamond coated) or PCD/CBN tipped.																										
																							P			
																							M			
																							K			
																							N			
																							S			
																							H			



Fräsen mit Wertschneidplatten
Milling with indexable inserts

Schnittwertempfehlungen für Wechsellatte WPR-AR/AS/WRT Schruppen Cutting data recommendations for indexable insert WPR-AR/AS/WRT Roughing

	Werkstoff	Material	Werkstoff-Nr. Material No.	DIN Bezeichnung Alt DIN Description Old	R _m /UTS (N/mm ²)	DIN Bezeichnung Neu DIN Description New	
P	Unlegierter Baustahl + Automatenstahl	Plain carbon steel + free cutting steel	1.0570	St52-3	-700	S355J2G3	
			1.1730	C45	-800	C45U	
			1.0715	9SMn28	-700	11SMn30	
	Vergütungsstahl, mittelfest	Heat-treatment steel, medium strength	1.1191	Ck45	500-950	C45E	
			1.7219	26CrMo4	500-950	26CrMo4-2	
	Stahlguss	Cast steel	1.7225	42CrMo4	500-950	42CrMo4	
			1.8159	51CrV4	-950	51CrV4	
	Einsatzstahl	Case hardening steel	1.0416	GS40	-950	GS40	
			1.7131	16MnCr5	-950	16MnCr5	
	Rost- und säurebe- ständiger Stahl, ferritisch, martensitisch	Stainless steel, ferritic, martensitic	1.4006	X10Cr13	500-950	X12Cr13	
			1.4104	X12CrMoS17	500-950	X14CrMoS17	
			1.4122	X35CrMo17	500-950	X39CrMo17-1	
	Vergütungsstahl, hochfest	Heat-treatment steel, high strength	1.7225	42CrMo4	950-1400	42CrMo4	
			1.6580	30CrNiMo8	950-1400	30CrNiMo8	
	Nitrierstahl, vergütet	Nitriding steel, heat treated	1.8504	34CrAl6	950-1400	34CrAl6	
1.2344			X40CrMoV5.1	-900	X40CrMoV5-1		
Werkzeugstahl	Tool steel	1.2343	X38CrMoV5 1	950-1400	X37CrMoV5-1		
		1.2379	X155CrVMo12 1	-950	X153CrMoV12-1		
		1.2358	60CrMoV18-5	850-1000	60CrMoV18-5		
		1.2080	X210Cr12	950-1400	X210Cr12		
		1.2714	55NiCrMoV7	1100-1350	55NiCrMoV7		
		1.2311	40CrMnMo7	-1100	40CrMnMo7		
		1.2312	40CrMnNiMoS8.6	-1150	40CrMnNiMoS8-6		
		1.2316	X38CrMo16	-1100	X38CrMo16		
1.2738	45CrMnNiMo8.6.4	950-1150	45CrMnNiMo8-6-4				
M	Rost- und säurebe- ständiger Stahl, austenitisch	Stainless steel, austenitic	1.4301	X2CrNiMo17-12-2	500-950	X5CrNiMo18-10	
			1.4404	X6CrNiMoTi17-12-2	500-950	X2CrNiMo17-12-2	
			1.4571	X10CrNiMoTi18	500-950	X10CrNiMoTi18	
Rost- und säurebe- ständiger Stahl, martensitisch aushärtbar	Stainless steel, martensitic steel	Stainless steel, martensitic steel	1.2709	X3NiCoMoTi18-9-5	800-1000	X3NiCoMoTi18-9-5	
			1.4542	X5CrNiCuNb16-4	800-1000	X5CrNiCuNb16-4	
			1.4568	X7CrNiAl17-7	800-1000	X7CrNiAl17-7	
K	Grauguss	Grey cast iron	0.6025	GG25	100-400 (120-260 HB)	EN-GJI-250	
			0.6678	GGL-NiCr35 2	150-250	EN-GJLA-XNiCr35-2	
					160-230 HB	EN-GJLA-XNiCr35-2	
					400-800	EN-GJLA-XNiCr35-2	
Sphäroguss	Nodular cast iron	0.7060	GGG60	400-800	EN-GJS-600-3		
		0.7070	GGG70L	(120-310 HB)	EN-GJS-700-2U		
Temperguss	Malleable cast iron	0.8155	GTS55	350-700	EN-GJMB-550-4		
				(150-280 HB)	EN-GJMB-550-4		
N	Aluminium-Legierungen, kurzspanend	Aluminium alloys, short chipping	3.2581	G-AlSi12	-400	G-IGK-AlSi12	
			3.3535	AlMg3	-550	AlMg3	
	Aluminium-Legierungen, langspanend	Aluminium alloys, long chipping	3.4365	AlZnMgCu1,5	-550	AlZnMgCu1,5	
			2.0402	MS58	-500	CuZn40Pb2	
	Kupfer-Legierungen, kurzspanend	Copper alloys, short chipping	2.0320	MS63	300-500	CuZn37	
			2.0975	CuAl10Ni	300-500	CuAl10Fe5Ni5-C	
	Kupfer-Legierungen, langspanend	Copper alloys, long chipping	2.0320	MS63	300-500	CuZn37	
			2.0975	CuAl10Ni	300-500	CuAl10Fe5Ni5-C	
Thermoplaste	Thermoplastics		PVC	40-70	PVC		
Duroplaste	Duroplastics		Bakelit, Melamin	20-40	Bakelit, Melamin		
Graphit	Graphite						
Zirkonoxidkeramik	Zircon oxide ceramics						
S	Titan-Legierungen, mittelfest	Titanium alloys, medium strength	3.7115	TiAl5Sn2,5	-950	TiAl5Sn2-5	
			3.7164	TiAl6V4	-950	TiAl6V4	
	Titan-Legierungen, hochfest	Titanium alloys, high strength	3.7174	TiAl6Sn2	900-1400	TiAl6V6Sn2	
			2.4670	NiCr12Al6MoNb	-950	NiCr12Al6MoNb	
	Nickelbasis-Legierungen, mittelfest	Nickel based alloys, medium strength	2.4670	NiCr12Al6MoNb	-950	NiCr12Al6MoNb	
Nickelbasis-Legierungen, hochwarmfest	Heat resistant nickel based alloys, high strength	2.4668	NiCr19Fe19NbMo	900-1400	Inconel 718		
		2.4668	NiCr19Fe19NbMo	900-1400	NiCr19Fe19Nb5Mo3		
Kobalt-Chrom-Legierung	Cobalt chromium alloys						
H	Hartguss	Chilled cast iron		Ni-hard, Ampco	300-600 HB	Ni-hard, Ampco	
			Gehärteter Stahl	Hardened steel		45-52 HRC	
						53-59 HRC	
				60-65 HRC			

Die angegebenen Schnittwerte sind Startwerte und müssen auf die vorhandenen Bedingungen abgestimmt werden.

Schnittgeschwindigkeit Cutting speed v_c (m/min)					Vorschub pro Zahn Feed per tooth f_z (mm/z.)					a_e Schruppen Roughing
					\varnothing 12	\varnothing 16	\varnothing 20	\varnothing 25	\varnothing 32	
WPR-AR LCPK30M	WPR-AR LCHK30M	WPR-AS LWNS30M	WRT LCP40M	WRT LCPK10M	a_p max f_z max	a_p max f_z max	a_p max f_z max	a_p max f_z max	a_p max f_z max	
160-180	160-180		160-180		d : 4,00 0,25	d : 4,00 0,35	d : 4,00 0,40	d : 4,00 0,45	d : 4,00 0,50	d x 0,1-0,12
160-180	160-180		160-180		d : 4,00 0,25	d : 4,00 0,35	d : 4,00 0,40	d : 4,00 0,45	d : 4,00 0,50	
140-160	140-160		140-160		d : 4,00 0,25	d : 4,00 0,35	d : 4,00 0,40	d : 4,00 0,45	d : 4,00 0,50	
140-160	140-160				d : 4,00 0,25	d : 4,00 0,35	d : 4,00 0,40	d : 4,00 0,45	d : 4,00 0,50	
120-140	120-140				d : 4,00 0,20	d : 4,00 0,30	d : 4,00 0,35	d : 4,00 0,40	d : 4,00 0,45	
140-160	140-160				d : 4,00 0,20	d : 4,00 0,30	d : 4,00 0,35	d : 4,00 0,40	d : 4,00 0,45	
160-180					d : 4,00 0,25	d : 4,00 0,35	d : 4,00 0,40	d : 4,00 0,45	d : 4,00 0,50	
160-200	160-200				d : 4,00 0,25	d : 4,00 0,35	d : 4,00 0,40	d : 4,00 0,45	d : 4,00 0,50	
120-140	120-140				d : 5,00 0,20	d : 5,00 0,30	d : 5,00 0,35	d : 5,00 0,40	d : 5,00 0,45	d x 0,08-0,1
100-120	100-120				d : 5,00 0,20	d : 5,00 0,30	d : 5,00 0,35	d : 5,00 0,40	d : 5,00 0,45	
120-140	120-140			180-200	d : 3,00 0,25	d : 3,00 0,35	d : 3,00 0,40	d : 3,00 0,45	d : 3,00 0,50	d x 0,1-0,12
120-140	120-140			160-180	d : 3,00 0,25	d : 3,00 0,35	d : 3,00 0,40	d : 3,00 0,45	d : 3,00 0,50	
180-200	180-200			180-200	d : 3,00 0,25	d : 3,00 0,35	d : 3,00 0,40	d : 3,00 0,45	d : 3,00 0,50	
160-180	160-180			140-160	d : 3,00 0,25	d : 3,00 0,35	d : 3,00 0,40	d : 3,00 0,45	d : 3,00 0,50	
		400-600			d : 3,00 0,25	d : 3,00 0,35	d : 3,00 0,40	d : 3,00 0,45	d : 3,00 0,50	d x 0,1-0,12
		400-500			d : 3,00 0,25	d : 3,00 0,35	d : 3,00 0,40	d : 3,00 0,45	d : 3,00 0,50	
		300-350			d : 3,00 0,25	d : 3,00 0,35	d : 3,00 0,40	d : 3,00 0,45	d : 3,00 0,50	
		250-300			d : 3,00 0,25	d : 3,00 0,35	d : 3,00 0,40	d : 3,00 0,45	d : 3,00 0,50	
		400-500			d : 3,00 0,25	d : 3,00 0,35	d : 3,00 0,40	d : 3,00 0,45	d : 3,00 0,50	
		200-250			d : 3,00 0,25	d : 3,00 0,35	d : 3,00 0,40	d : 3,00 0,45	d : 3,00 0,50	
		80-100			1,50-2,00 0,25	2,50-3,00 0,35	3,00-3,50 0,40	3,00-4,00 0,45	4,00 0,50	d x 0,08-0,1
		60-80			1,50-2,00 0,25	2,50-3,00 0,35	3,00-3,50 0,40	3,00-4,00 0,45	4,00 0,50	
		60-80			1,50-2,00 0,25	2,50-3,00 0,35	3,00-3,50 0,40	3,00-4,00 0,45	4,00 0,50	
		40-60			1,50-2,00 0,25	2,50-3,00 0,35	3,00-3,50 0,40	3,00-4,00 0,45	4,00 0,50	
100-120	100-120			120-140	1,00-1,50 0,20	2,00-2,50 0,30	2,50-3,00 0,35	3,00-3,50 0,40	3,50-4,00 0,45	d x 0,08-0,1
160-180	160-180			160-180	1,50-2,00 0,25	2,50-3,00 0,35	3,00-3,50 0,40	3,00-4,00 0,45	4,00 0,50	d x 0,1-0,12
140-160	140-160			140-160	1,50-2,00 0,25	2,50-3,00 0,35	3,00-3,50 0,40	3,00-4,00 0,45	4,00 0,50	d x 0,08-0,1
				120-140						

The cutting data indicated are starting values and must be adjusted to the prevailing conditions.

Die Anforderungen beim Schlichten im Gesenk- und Formenbau sind Prozesssicherheit, gute Oberflächenqualität und längere Standzeiten. Die Geometrie SF (SuperFinish) setzt genau in diesen Punkten neue Maßstäbe. Durch eine hochpräzise Schneidengeometrie mit optimierter Schneidkantenpräparation sind Standzeitverbesserungen > 30 % realisierbar.

Sie haben die Wahl!

Durch den Einsatz der WPR-SF werden Sie noch größere Bauteile ohne einen Schneidwechsel bearbeiten können. Oder Sie reduzieren deutlich Ihre Bearbeitungszeit durch optimieren der Schnittparameter.

Vorteile:

- Reduzierung der Bearbeitungszeit um 25 %
- Nacharbeit, bedingt durch den Wendepplattenwechsel entfällt
- Werkzeugkosten deutlich niedriger
- Speziell für den Gesenk- und Formenbau entwickelte Sorte, Nanomold Red

Merkmale:

- Hochgenaue Geometrie zum Schlichten von gehärtetem Stahl bis 65 HRC
- Zum Schlichten und Semi-Schlichten von hochfestem Stahl
- Für Bauteile mit sehr langen Bearbeitungszeiten
- Polierte Schneidkante mit hochpräziser Schneidkantenpräparation für hohe Prozesssicherheit auch bei mannloser Fertigung
- Sehr hohe Form- und Wechselgenauigkeit
- Optimiertes Fräshalterprogramm mit noch mehr Stabilität und Verschleißbeschichtung im vorderen Bereich

The requirements with regard to finishing in mold and die manufacturing are process reliability, good surface quality and an extended tool life. The SF (SuperFinish) geometry sets new standards for exactly these issues. Due to a high-precision cutting edge geometry with an optimized cutting edge preparation, we make it possible to realize tool life improvements of > 30 %.

It's your choice!

When using the WPR-SF, you will be able to machine even larger components without having to replace any cutting inserts. Or you reduce your machining time significantly by optimizing the cutting parameters.

Benefits:

- Reduction of the machining time by 25 %
- No rework after replacing the indexable inserts
- Significantly reduced tool costs
- Mold and die optimized grade, Nanomold Red

Features:

- High-precision geometry for finishing hardened steel up to 65 HRC
- For finishing and semi-finishing high-strength steel
- For components with very long machining times
- Polished cutting edge with high-precision cutting edge preparation for high process reliability even in manless production
- Very high dimensional and indexing accuracy
- Optimized milling tool holder product line with increased stability and wear-resistant front coating



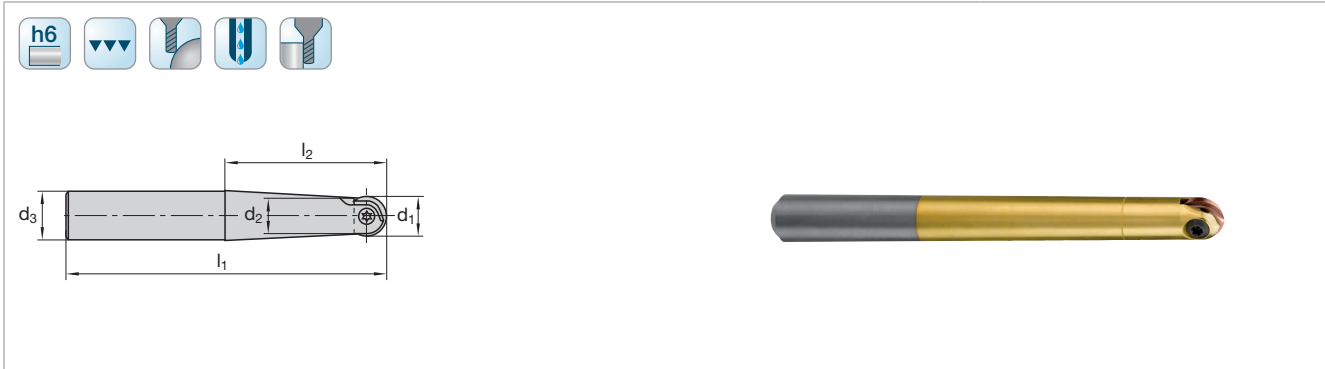



Katalog-Nr. Cat.-No.							GWR				
d ₁	l ₂	l ₁	d ₃	d ₂	z	Ident No.	LMT-Code		1)		
12	80	120	12	10,5	2	7057318	EBG R 12.012AN120-C-I-SF	WPR 12	GWS 12	T20	
16	50	100	16	14	2	7057319	EBG R 16.016AN100-C-I-SF	WPR 16	GWS 16		
16	100	150	16	14	2	7057320	EBG R 16.016AN150-C-I-SF		GWS 16		
20	100	150	20	18	2	7057321	EBG R 20.020AN150-C-I-SF	WPR 20	GWS 20		

1) Anzugsmoment siehe Tabelle Seite 345
 Torque see overview page 345

Schnittwertempfehlungen ab Seite 348
 Cutting data recommendations starting page 348

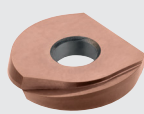
Ident No. Schrauben und Torx-Schraubendreher siehe Seite 369
 Ident No. Screws and wrenches see page 369

<p>Aufgabe Application Schlichten einer Großform in der Automobilblechumformung Finishing of a large automotive die</p> <p>Material Material GGG70L & 1.2333 58 HRC</p> <p>Werkstück soll mit nur einem Werkzeug fertig bearbeitet werden. Finishing with one single insert.</p> <p>Werkstück soll auch mannlos bearbeitet werden. Unmanned machining</p>	<p>Lösung Solution Fräser EBG R16.016AN140-C-I Mill EBG R16.016AN140-C-I</p> <p>Schneidplatte Insert WPR 16 SF LCKP10M</p> <p>Schnittdaten Parameters</p> <p>$a_p = 0,2 \text{ mm}$ $a_e = 0,3 \text{ mm}$ $v_c = 310 \text{ m/min}$ $f_z = 0,45 \text{ mm}$</p> 	<p>Kundennutzen Customer benefit</p> <ul style="list-style-type: none"> ■ Standzeit ca. 9 Stunden ■ Luftkühlung gutes Entfernen der Späne ■ Prozesssichere Bearbeitung, kann mannlos durchgeführt werden ■ Tool life approx. 9 hours ■ Air supply chip removal ■ Very reliable process, allowing unmanned machining 
--	--	--

Fräsen mit Wendeschneidplatten
 Milling with indexable inserts

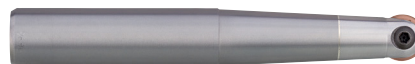
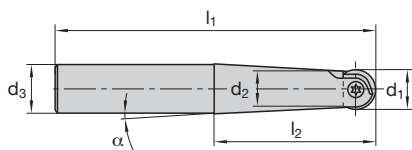

Katalog-Nr. Cat.-No.								GWR 5x					
d ₁	l ₂	l ₁	d ₃	d ₂	α	z	Ident No.	LMT-Code					
6	40	100	8	5,8	1,50°	2	6128437	EBG R06.006AP100-C-1,50	WPR 06	WPB 06	GWS 06	T6	
6	40	90	8	5,8	1,75°	2	9153236	EBG R06.006AP090-C-1,75					
6	30	90	8	5,8	3,00°	2	9198390	EBG R06.006AP090-C-3,00					
6	65	110	8	5,8	1,00°	2	9198458	EBG R06.006AP110-C-1,00	WPR 08	WPB 08	GWS 08	T8	
8	60	100	10	7	1,25°	2	9148824	EBG R08.008AP100-C-1,25					
8	35	100	10	7	1,50°	2	9198493	EBG R08.008AP100-C-1,50					
8	35	100	10	7	3,00°	2	9198487	EBG R08.008AP100-C-3,00	WPR 10	WPB 10	GWS 10	T15	
8	90	150	10	7	1,00°	2	9148825	EBG R08.008AP150-C-1,00					
10	60	100	12	8,8	1,25°	2	9148826	EBG R10.010AP100-C-I-1,25					
10	90	150	12	8,8	1,00°	2	9148827	EBG R10.010AP150-C-I-1,00	WPR 12	WPB 12	GWS 12	T20	
12	70	120	16	10,5	2,00°	2	9148828	EBG R12.012AR120-C-I-2,00					
12	90	150	16	10,5	1,50°	2	9148919	EBG R12.012AR150-C-I-1,50					
16	70	140	20	14	2,00°	2	9148920	EBG R16.016AR140-C-I-2,00	WPR 16	WPB 16	GWS 16	T30	
16	90	175	20	14	1,50°	2	9148821	EBG R16.016AR175-C-I-1,50					

Ident No. Schrauben und Torx-Schraubendreher siehe Seite 369
 Ident No. Screws and wrenches see page 369

Schnittwertempfehlungen ab Seite 348
 Cutting data recommendations starting page 348

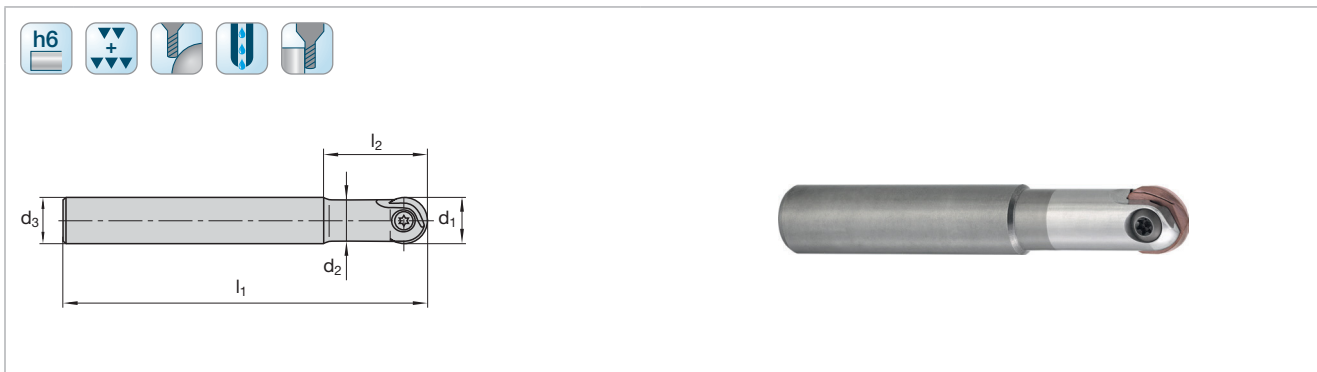

Katalog-Nr. Cat.-No.							GWR						
d ₁	l ₂	l ₁	d ₃	d ₂	z	Ident No.	IKZ ¹⁾	LMT-Code					
6	20	100	6 <i>SlimLine</i>	5,8	2	6130088	-	EBG R06.006AN100-C	WPR 06	WPB 06	GWS 06	T6	
6	70	150	6 <i>SlimLine</i>	5,8	2	6130086	-	EBG R06.006AN150-C					
6	100	200	6 <i>SlimLine</i>	5,8	2	6130084	-	EBG R06.006AN200-C					
8	25	80	8	7	2	6131495	-	EBG R08.008AN080-C	WPR 08		GWS 08	T8	
8	25	100	8	7	2	6121301	-	EBG R08.008AN100-C					
8	40	150	8	7	2	6121284	-	EBG R08.008AN150-C					
10	35	80	10	8,8	2	9074942	6131499	EBG R10.010AN080-C-I	WPR 10		GWS 10	T15	
10	35	120	10	8,8	2	6121285	6130392	EBG R10.010AN120-C-I					
10	50	150	10	8,8	2	6121286	6130393	EBG R10.010AN150-C-I					
12	35	80	12	10,5	2	9074945	6131500	EBG R12.012AN080-C-I	WPR 12		GWS 12	T20	
12	35	120	12	10,5	2	6121287	6130394	EBG R12.012AN120-C-I					
12	50	160	12	10,5	2	6121288	6130395	EBG R12.012AN160-C-I					
16	40	100	16	14	2	-	6131501	EBG R16.016AN100-C-I	WPR 16		GWS 16		
16	40	140	16	14	2	-	6130396	EBG R16.016AN140-C-I					
16	55	175	16	14	2	-	6130397	EBG R16.016AN175-C-I					
20	50	100	20	18	2	-	6131503	EBG R20.020AN100-C-I	WPR 20		GWS 20		
20	50	140	20	18	2	-	6130398	EBG R20.020AN140-C-I					
20	75	190	20	18	2	-	6130399	EBG R20.020AN190-C-I					
25	60	160	25	22,4	2	-	6130400	EBG R25.025AN160-C-I	WPR 25		GWS 25	T30	
25	90	210	25	22,4	2	-	6130401	EBG R25.025AN210-C-I					
32	65	190	32	28,6	2	6121277	-	EBG R32.032AN190-C					
32	105	240	32	28,6	2	6121278	-	EBG R32.032AN240-C	WPR 32		GWS 32		

¹⁾ mit IKZ = Innere Kühlmittelzufuhr
with IKZ = Internal coolant supply

²⁾ Anzugsmoment siehe Tabelle Seite 345
Torque see overview page 345

Drehmomentschlüssel auf Anfrage
Torque spanner on request



Ident No. Schrauben und Torx-Schraubendreher siehe Seite 369
Ident No. Screws and wrenches see page 369

Fräser auch verfügbar in Zoll-Abmessungen
Cutters also available in inch dimensions

Schnittwertempfehlungen ab Seite 348
Cutting data recommendations starting page 348

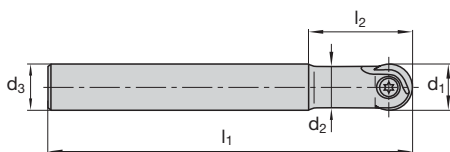
Fräser mit Wendeschneidplatten
Milling with indexable inserts



Katalog-Nr. Cat.-No.							GWR				
d ₁	l ₂	l ₁	d ₃	d ₂	z	Ident No.	LMT-Code		 ¹⁾		
12	32	90	12	10,5	2	6130568	EBG R12.012AN090	WPR 12	GWS 12	T20	
12	32	130	12	10,5	2	6121395	EBG R12.012AN130				
12	46	150	12	10,5	2	6121397	EBG R12.012AN150				
16	36	100	16	14	2	6130569	EBG R16.016AN100	WPR 16	GWS 16	T20	
16	36	140	16	14	2	6121385	EBG R16.016AN140				
16	53	160	16	14	2	6121387	EBG R16.016AN160				
20	45	160	20	18	2	6121382	EBG R20.020AN160	WPR 20	GWS 20	T20	
20	61	175	20	18	2	6121375	EBG R20.020AN175				
25	45	160	25	22,4	2	6121367	EBG R25.025AN160	WPR 25	GWS 25	T30	
25	70	190	25	22,4	2	6121369	EBG R25.025AN190				
30	56	175	32	27	2	6200387	EBG R30.030AP175	WPR 30	GWS 32	T30	
30	80	210	32	27	2	6121350	EBG R30.030AP210				
32	56	175	32	28,6	2	6121359	EBG R32.032AN175	WPR 32	GWS 32	T30	
32	80	210	32	28,6	2	6121361	EBG R32.032AN210				

¹⁾ Anzugsmoment siehe Tabelle Seite 345
 Torque see overview page 345

Schnittwertempfehlungen ab Seite 348
 Cutting data recommendations starting page 348



IKZ auf Anfrage
 Internal cooling on request

Drehmomentschlüssel auf Anfrage
 Torque spanner on request

Ident No. Schrauben und Torx-Schraubendreher siehe Seite 369
 Ident No. Screws and wrenches see page 369

Fräser auch verfügbar in Zoll-Abmessungen
 Cutters also available in inch dimensions



Katalog-Nr. Cat.-No.								GWR				
d ₁	l ₂	l ₁	MK	l ₄	d ₂	z	Ident No.	LMT-Code		 ¹⁾		
12	36	115	2	51	10,5	2	6121337	EBG R12.012M2115	WPR 12	GWS 12	T20	
12	53	130	2	60	10,5	2	6121320	EBG R12.012M2130				
16	36	115	2	51	14	2	6121323	EBG R16.016M2115	WPR 16	GWS 16		
16	53	130	2	60	14	2	6121324	EBG R16.016M2130				
20	45	125	2	61	17,8	2	6121327	EBG R20.020M2125	WPR 20	GWS 20		
20	61	140	2	76	17,8	2	6121328	EBG R20.020M2140				
25	45	145	3	64	22,4	2	6121315	EBG R25.025M3145	WPR 25	GWS 25	T30	
25	70	170	3	89	22,4	2	6121316	EBG R25.025M3170				
32	70	165	4	62,5	28,6	2	6121319	EBG R32.032M4165	WPR 32	GWS 32		
32	70	190	4	87,5	28,6	2	6121311	EBG R32.032M4190				

¹⁾ Anzugsmoment siehe Tabelle Seite 345
 Torque see overview page 345





Schnittwertempfehlungen ab Seite 348
 Cutting data recommendations starting page 348

IKZ auf Anfrage
 Internal cooling on request

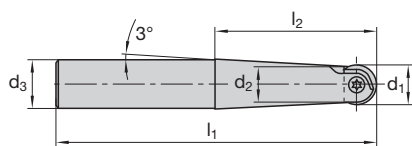
Drehmomentschlüssel auf Anfrage
 Torque spanner on request

Ident No. Schrauben und Torx-Schraubendreher siehe Seite 369
 Ident No. Screws and wrenches see page 369



Katalog-Nr. Cat.-No.							GWR						
d ₁	l ₂	l ₁	d ₃	d ₂	z	Ident No.	LMT-Code				 ¹⁾		
6	16	90	10	5,3	2	6128481	EBG R06.006AR090	WPR 06		WPB 06	GWS 06	T6	
8	50	85	12	7,5	2	6130570	EBG R08.008AR085	WPR 08	WPV 08	WPB 08	GWS 08	T8	
8	50	140	12	7,5	2	6121409	EBG R08.008AR140						
10	35	85	12	9	2	6130571	EBG R10.010AP085	WPR 10	WPV 10	WPB 10	GWS 10	T15	
10	35	150	12	9	2	6121401	EBG R10.010AP150						
12	60	110	16	10,5	2	6130572	EBG R12.012AR110	WPR 12			GWS 12	T20	
12	60	160	16	10,5	2	6121402	EBG R12.012AR160						
16	67	120	20	14	2	6130573	EBG R16.016AR120	WPR 16			GWS 16		
16	67	175	20	14	2	6121403	EBG R16.016AR175						
20	80	190	25	18	2	6121404	EBG R20.020AS190	WPR 20			GWS 20		
25	100	210	32	22,4	2	6121405	EBG R25.025AV210	WPR 25			GWS 25	T30	
32	123	240	40	28,6	2	6121392	EBG R32.032AW240	WPR 32			GWS 32		

¹⁾ Anzugsmoment siehe Tabelle Seite 345
 Torque see overview page 345

Schnittwertempfehlungen ab Seite 348
 Cutting data recommendations starting page 348

IKZ auf Anfrage
 Internal cooling on request

Drehmomentschlüssel auf Anfrage
 Torque spanner on request

Ident No. Schrauben und Torx-Schraubendreher siehe Seite 369
 Ident No. Screws and wrenches see page 369

Fräser auch verfügbar in Zoll-Abmessungen
 Cutters also available in inch dimensions

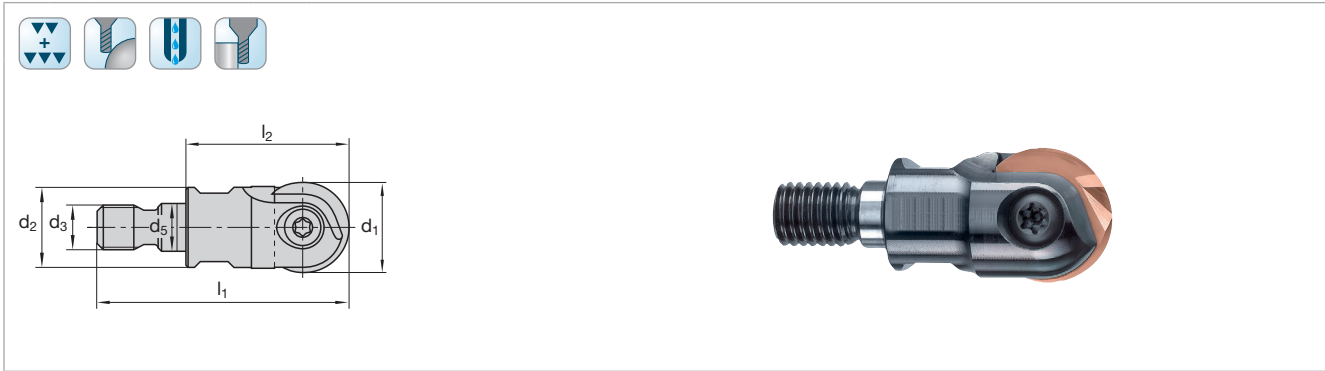

Katalog-Nr.		Cat.-No.		GWR											
d ₁	l ₂	l ₁	sw	d ₃	d ₅	d ₂	z	IKZ ¹⁾	Ident No.	LMT-Code					
8	25	39,5	8	M6	6,5	10	2	-	6131455	EBG R08.008TC025	WPR 08	WPV 08	WPB 08	GWS 08	T8
10	25	39,5	8	M6	6,5	10	2	-	6131457	EBG R10.010TC025	WPR 10	WPV 10	WPB 10	GWS 10	T15
12	25	39,5	8	M6	6,5	10	2	-	6131451	EBG R12.012TC025	WPR 12			GWS 12	T20
12	26	43,5	10	M8	8,5	13	2	■	6131459	EBG R12.012TR026-I					
16	26	43,5	10	M8	8,5	13	2	■	6131461	EBG R16.016TR26-I	WPR 16			GWS 16	
20	30	49,5	15	M10	10,5	18	2	■	6131463	EBG R20.020TS030-I	WPR 20			GWS 20	
25	40	62	17	M12	12,5	21	2	■	6131465	EBG R25.025TF040-I	WPR 25			GWS 25	T30
32	45	69	26	M16	17	30	2	■	6131470	EBG R32.032TH045-I	WPR 32			GWS 32	

¹⁾ mit IKZ = Innere Kühlmittelzufuhr
with IKZ = Internal coolant supply

²⁾ Anzugsmoment siehe Tabelle Seite 345
Torque see overview page 345

Drehmomentschlüssel auf Anfrage
Torque spanner on request

Ident No. Schrauben und Torx-Schraubendreher siehe Seite 369
Ident No. Screws and wrenches see page 369

Fräser auch verfügbar in Zoll-Abmessungen
Cutters also available in inch dimensions

Schnittwertempfehlungen ab Seite 348
Cutting data recommendations starting page 348

Anzugsmomente Wendeschneidplattenfräser
Torques indexable insert cutters

EBG R... / EBG V... Anzugsmomente Torque in Nm						
	Ident No.		T	Werkzeugtyp Tool type		
				GRT	GWR	GWV
GWS 06	6260409		T6	-	0,5	0,5
GWS 08	6119572		T8	-	1	1
GWS 10	6119571		T15	-	3	3
GWS 12	6119559		T20	-	4	4
GWS 16	6119560		T20	-	5	5
GWS 20	6119561		T20	-	5	5
GWS 25	6119562		T30	8	8	8
GWS 32	6119563		T30	8	8	8

		Schneidstoffsorten											Für Fräser For cutter								
		Cutting materials																			
N = Anzahl der Schneidkanten N = Number of cutting edges	ISO-Code	l	d	s	d ₁	r	LWP40M	LWNS30M	LWNS10M	LWNS33M	LCP40M	LCPK30M	LCPK10M	LCPK25M	LCPK15M	LCKP10M	LCHK10M	LCH33M	LCN10M	LDN10M	Cat-No.
							Ident No.														
 N = 2	WPR 8 SF	-	8	2	3	4											7100806	7100808			EBG R 08...SF
	WPR 10 SF	-	10	2,5	4	5											7100801	7100804			EBG R 10...SF
	WPR 12 SF	-	12	2,5	5	6											7057312	7057313			EBG R 12...SF
	WPR 16 SF	-	16	3	5	8											7057314	7057315			EBG R 16...SF
	WPR 20 SF	-	20	3	5	10											7057316	7057317			EBG R 20...SF
	WPR 25 SF	-	25	4	6	12,5											7100734	7100736			EBG R 25...SF
																<input checked="" type="checkbox"/>	<input type="checkbox"/>			P	
																<input type="checkbox"/>	<input type="checkbox"/>			M	
																<input checked="" type="checkbox"/>	<input checked="" type="checkbox"/>			K	
																<input type="checkbox"/>	<input type="checkbox"/>			N	
																<input type="checkbox"/>	<input type="checkbox"/>			S	
																<input checked="" type="checkbox"/>	<input checked="" type="checkbox"/>			H	

■ = Hauptanwendung First choice
 □ = Nebenanwendung Alternative

Sortenbeschreibung/-bezeichnung und ISO-Code ab Seite 424/477
 Description/Designation of grades and ISO-Code starting page 424/477

Alle WPR-, WPV- und WPB-Wendepplatten sind in der Sorte LCN10M (diamantbeschichtet) oder PKD/CBN-bestückt auf Anfrage lieferbar.
 All WPR, WPV and WPB inserts are available in grade LCN10M (diamond coated) or PCD/CBN tipped.

Zum Schlichten von Stahl, Stahlguss und gehärteten Stählen bis 65 HRC
 For finishing of steel, cast steel and hardened steels up to 65 HRC



Fräsen mit Wendeschneidplatten
Milling with indexable inserts

Schnittwertempfehlungen für Wechsellatte WPR-SF Schlichten
Cutting data recommendations for indexable insert WPR-SF Finishing

	Werkstoff	Material	Werkstoff-Nr. Material No.	DIN Bezeichnung Alt DIN Description Old	R_m/UTS (N/mm²)	DIN Bezeichnung Neu DIN Description New
P	Unlegierter Baustahl + Automatenstahl	Plain carbon steel + free cutting steel	1.0570	St52-3	-700	S355J2G3
			1.1730	C45	-800	C45U
			1.0715	9SMn28	-700	11SMn30
	Vergütungsstahl, mittelfest	Heat-treatment steel, medium strength	1.1191	Ck45	500-950	C45E
			1.7219	26CrMo4		26CrMo4-2
	Stahlguss	Cast steel	1.7225	42CrMo4	500-950	42CrMo4
			1.8159	51CrV4		51CrV4
	Einsatzstahl	Case hardening steel	1.0416	GS40	-950	GS40
			1.7131	16MnCr5	-950	16MnCr5
	Rost- und säurebe- ständiger Stahl, ferritisch, martensitisch	Stainless steel, ferritic, martensitic	1.4006	X10Cr13	500-950	X12Cr13
			1.4104	X12CrMoS17		X14CrMoS17
			1.4122	X35CrMo17		X39CrMo17-1
	Vergütungsstahl, hochfest	Heat-treatment steel, high strength	1.7225	42CrMo4	950-1400	42CrMo4
			1.6580	30CrNiMo8		30CrNiMo8
	Nitrierstahl, vergütet	Nitriding steel, heat treated	1.8504	34CrAl6	950-1400	34CrAl6
			1.2344	X40CrMoV5.1	-900	X40CrMoV5-1
	Werkzeugstahl	Tool steel	1.2343	X38CrMoV5 1	950-1400	X37CrMoV5-1
			1.2379	X155CrVMo12 1	-950	X153CrMoV12-1
1.2358			60CrMoV18-5	850-1000	60CrMoV18-5	
1.2080			X210Cr12	950-1400	X210Cr12	
1.2714			55NiCrMoV7	1100-1350	55NiCrMoV7	
1.2311			40CrMnMo7	-1100	40CrMnMo7	
1.2312			40CrMnNiMoS8.6	-1150	40CrMnNiMoS8-6	
1.2316			X38CrMo16	-1100	X38CrMo16	
1.2738	45CrMnNiMo8.6.4	950-1150	45CrMnNiMo8-6-4			
M	Rost- und säurebe- ständiger Stahl, austenitisch	Stainless steel, austenitic	1.4301	X2CrNiMo17-12-2	500-950	X5CrNiMo18-10
			1.4404	X6CrNiMoTi17-12-2		X2CrNiMo17-12-2
			1.4571	X10CrNiMoTi18		X10CrNiMoTi18
Rost- und säurebe- ständiger Stahl, martensitisch aushärtbar	Stainless steel, martensitic steel	1.2709	X3NiCoMoTi18-9-5	800-1000	X3NiCoMoTi18-9-5	
		1.4542	X5CrNiCuNb16-4		X5CrNiCuNb16-4	
		1.4568	X7CrNiAl17-7		X7CrNiAl17-7	
K	Grauguss	Grey cast iron	0.6025	GG25	100-400 (120-260 HB)	EN-GJI-250
			0.6678	GGL-NiCr35 2	150-250 (160-230 HB)	EN-GJLA-XNiCr35-2
	Sphäroguss	Nodular cast iron	0.7060	GGG60	400-800	EN-GJS-600-3
			0.7070	GGG70L	(120-310 HB)	EN-GJS-700-2U
Temperguss	Malleable cast iron	0.8155	GTS55	350-700 (150-280 HB)	EN-GJMB-550-4	
N	Aluminium-Legierungen, kurzspanend	Aluminium alloys, short chipping	3.2581	G-AlSi12	-400	G-IGK-AlSi12
	Aluminium-Legierungen, langspanend	Aluminium alloys, long chipping	3.3535	AlMg3	-550	AlMg3
			3.4365	AlZnMgCu1,5		AlZnMgCu1,5
	Kupfer-Legierungen, kurzspanend	Copper alloys, short chipping	2.0402	MS58	-500	CuZn40Pb2
			2.0320	MS63	300-500	CuZn37
	Kupfer-Legierungen, langspanend	Copper alloys, long chipping	2.0975	CuAl10Ni		CuAl10Fe5Ni5-C
				PVC	40-70	PVC
	Duroplaste	Duroplastics		Bakelit, Melamin	20-40	Bakelit, Melamin
Graphit	Graphite					
Zirkonoxidkeramik	Zircon oxide ceramics					
S	Titan-Legierungen, mittelfest	Titanium alloys, medium strength	3.7115	TiAl5Sn2,5	-950	TiAl5Sn2-5
			3.7164	TiAl6V4		Ti6AlV4
	Titan-Legierungen, hochfest	Titanium alloys, high strength	3.7174	TiAl6Sn2	900-1400	TiAl6V6Sn2
	Nickelbasis-Legierungen, mittelfest	Nickel based alloys, medium strength	2.4670	NiCr12Al6MoNb	-950	NiCr12Al6MoNb
	Nickelbasis-Legierungen, hochwarmfest	Heat resistant nickel based alloys, high strength	2.4668	NiCr19Fe19NbMo	900-1400	Inconel 718 NiCr19Fe19Nb5Mo3
Kobalt-Chrom-Legierung	Cobalt chromium alloys					
H	Hartguss	Chilled cast iron		Ni-hard, Ampco	300-600 HB	Ni-hard, Ampco
	Gehärteter Stahl	Hardened steel			45-52 HRC	
					53-59 HRC	
				60-65 HRC		

Die angegebenen Schnittwerte sind Startwerte und müssen auf die vorhandenen Bedingungen abgestimmt werden.

Schnittgeschwindigkeit Cutting speed v_c (m/min)		Vorschub pro Zahn Feed per tooth f_z (mm/z)						a_e Schlichten Finishing
		$\varnothing 8$	$\varnothing 10$	$\varnothing 12$	$\varnothing 16$	$\varnothing 20$	$\varnothing 25$	
WPR-SF LCHK10M	WPR-SF LCH33M	a_p max f_z max	a_p max f_z max	a_p max f_z max	a_p max f_z max	a_p max f_z max	a_p max f_z max	d x 0,02
260-280	290-310	0,12 0,15	0,15 0,20	0,15 0,20	0,20 0,35	0,25 0,40	0,30 0,45	
260-280	290-310	0,12 0,15	0,15 0,20	0,15 0,20	0,20 0,35	0,25 0,40	0,30 0,45	
280-300	310-330	0,12 0,15	0,15 0,20	0,15 0,20	0,20 0,35	0,25 0,40	0,30 0,45	
260-280	290-310	0,12 0,15	0,15 0,20	0,15 0,20	0,20 0,35	0,25 0,40	0,30 0,45	
240-260	270-290	0,12 0,15	0,15 0,20	0,15 0,20	0,20 0,35	0,25 0,40	0,30 0,45	
260-280	290-310	0,12 0,15	0,15 0,20	0,15 0,20	0,20 0,35	0,25 0,40	0,30 0,45	
280-300	310-330	0,12 0,15	0,15 0,20	0,15 0,20	0,20 0,35	0,25 0,40	0,30 0,45	
300-340	330-370	0,10 0,15	0,15 0,20	0,15 0,20	0,20 0,35	0,25 0,40	0,30 0,45	
220-240	240-260	0,12 0,15	0,15 0,20	0,15 0,20	0,20 0,35	0,25 0,40	0,30 0,45	d x 0,02
220-240	240-260	0,12 0,10	0,15 0,15	0,15 0,20	0,20 0,35	0,25 0,40	0,30 0,45	
300-320	330-350	0,15 0,15	0,15 0,20	0,20 0,25	0,20 0,35	0,30 0,40	0,40 0,50	d x 0,02
240-260	270-290	0,15 0,15	0,15 0,20	0,20 0,25	0,20 0,35	0,30 0,40	0,40 0,50	
320-340	350-370	0,15 0,15	0,15 0,20	0,20 0,25	0,20 0,35	0,30 0,40	0,40 0,50	
240-280	270-310	0,15 0,15	0,15 0,20	0,20 0,25	0,20 0,35	0,30 0,40	0,40 0,50	
								d x 0,02
350-400	380-440	0,20 0,15	0,20 0,20	0,20 0,25	0,20 0,35	0,30 0,40	0,40 0,50	
300-350	330-380	0,20 0,15	0,20 0,20	0,20 0,25	0,20 0,35	0,30 0,40	0,40 0,50	
								d x 0,02
180-200	200-220	0,10 0,10	0,10 0,15	0,10 0,18	0,15 0,20	0,20 0,25	0,25 0,30	
280-300	300-330	0,10 0,10	0,10 0,15	0,10 0,18	0,15 0,25	0,20 0,30	0,25 0,30	
240-260	270-290	0,10 0,10	0,10 0,12	0,10 0,18	0,15 0,20	0,20 0,25	0,25 0,30	
200-220	220-250	0,10 0,08	0,10 0,10	0,10 0,18	0,15 0,20	0,20 0,25	0,25 0,30	

The cutting data indicated are starting values and must be adjusted to the prevailing conditions.

 N = Anzahl der Schneidkanten N = Number of cutting edges		Schneidstoffsorten Cutting materials Ident No.											Für Fräser For cutter Cat-No.				
		LWP40M	LWNS30M	LWNS10M	LWNS33M	LCP40M	LCPK30M	LCPK10M	LCPK25M	LCPK15M	LCKP10M	LCHK30M		LCH33M	LCN10M	LDN10M	
ISO-Code	l	d	s	d ₁	r												
 N = 2	WPR 12 AR	-	12	2,5	5	6											EBG R 12
	WPR 16 AR	-	16	3	5	8											EBG R 16
	WPR 20 AR	-	20	3	5	10											EBG R 20
 N = 2	WPR 25 AR	-	25	4	6	12,5											EBG R 25
	WPR 32 AR	-	32	5	8	16											EBG R 32
																P	
																M	
																K	
																N	
																S	
																H	

■ = Hauptanwendung First choice
 □ = Nebenanwendung Alternative

Sortenbeschreibung/-bezeichnung und ISO-Code ab Seite 424/477
 Description/Designation of grades and ISO-Code starting page 424/477

Alle WPR-, WPV- und WPB-Wendplatten sind in der Sorte LCN10M (diamantbeschichtet) oder PKD/CBN-bestückt auf Anfrage lieferbar.
 All WPR, WPV and WPB inserts are available in grade LCN10M (diamond coated) or PCD/CBN tipped.

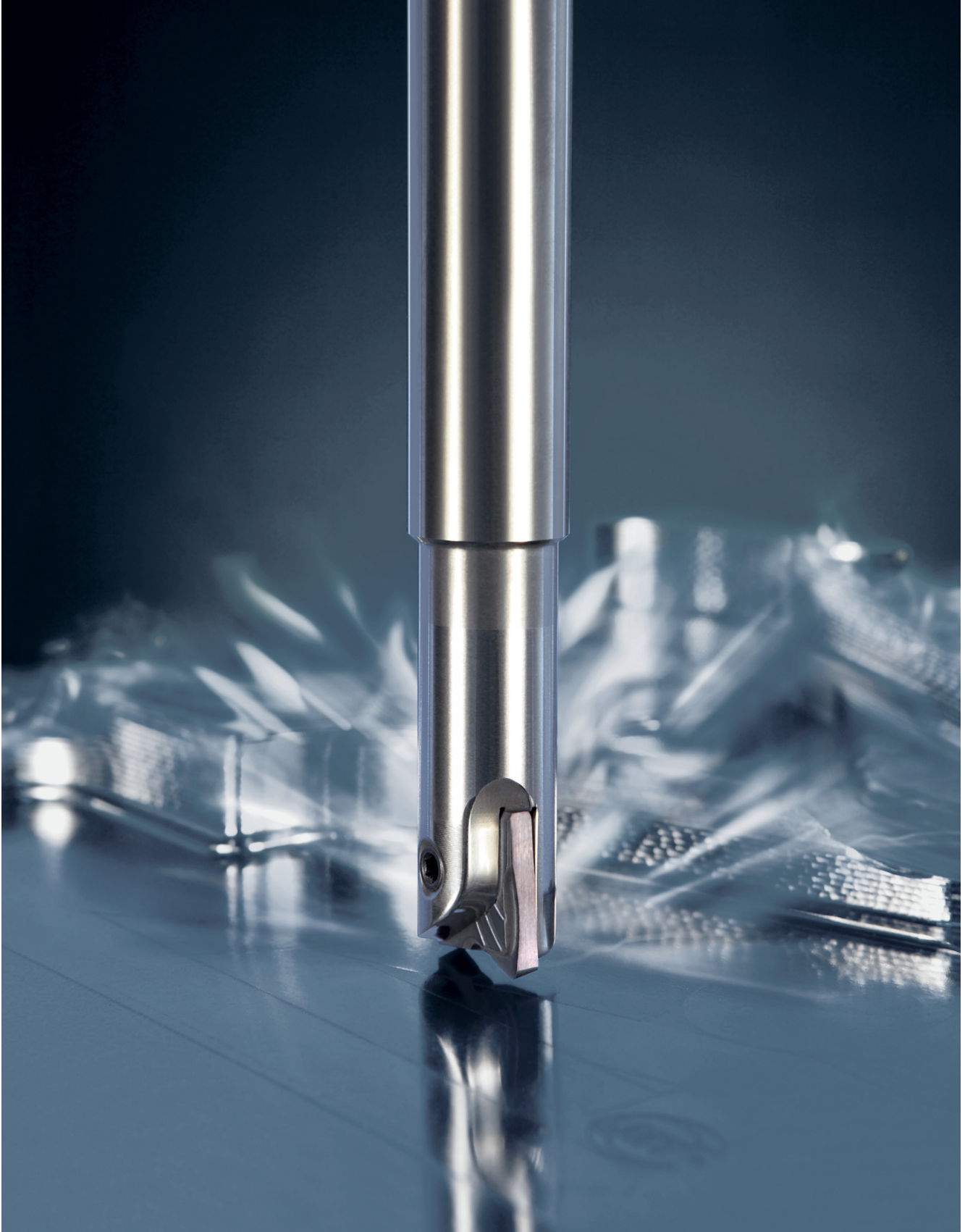

Fräsen mit Wertschneidplatten
Milling with indexable inserts

Schnittwertempfehlungen für Wechsellatte WPR-AR Schruppen Cutting data recommendations for indexable insert WPR-AR Roughing

	Werkstoff	Material	Werkstoff-Nr. Material No.	DIN Bezeichnung Alt DIN Description Old	R _m /UTS (N/mm ²)	DIN Bezeichnung Neu DIN Description New	
P	Unlegierter Baustahl + Automatenstahl	Plain carbon steel + free cutting steel	1.0570	St52-3	-700	S355J2G3	
			1.1730	C45	-800	C45U	
			1.0715	9SMn28	-700	11SMn30	
				1.1191	Ck45	500-950	C45E
				1.7219	26CrMo4		26CrMo4-2
	Vergütungsstahl, mittelfest	Heat-treatment steel, medium strength	1.7225	42CrMo4	500-950	42CrMo4	
	1.8159		51CrV4		51CrV4		
	Stahlguss	Cast steel	1.0416	GS40	-950	GS40	
	Einsatzstahl	Case hardening steel	1.7131	16MnCr5	-950	16MnCr5	
	Rost- und säurebe- ständiger Stahl, ferritisch, martensitisch	Stainless steel, ferritic, martensitic	1.4006	X10Cr13	500-950	X12Cr13	
			1.4104	X12CrMoS17		X14CrMoS17	
			1.4122	X35CrMo17		X39CrMo17-1	
	Vergütungsstahl, hochfest	Heat-treatment steel, high strength	1.7225	42CrMo4	950-1400	42CrMo4	
	1.6580		30CrNiMo8		30CrNiMo8		
Nitrierstahl, vergütet	Nitriding steel, heat treated	1.8504	34CrAl6	950-1400	34CrAl6		
1.2344		X40CrMoV5.1	-900	X40CrMoV5-1			
Werkzeugstahl	Tool steel	1.2343	X38CrMoV5 1	950-1400	X37CrMoV5-1		
		1.2379	X155CrVMo12 1	-950	X153CrMoV12-1		
		1.2358	60CrMoV18-5	850-1000	60CrMoV18-5		
		1.2080	X210Cr12	950-1400	X210Cr12		
		1.2714	55NiCrMoV7	1100-1350	55NiCrMoV7		
		1.2311	40CrMnMo7	-1100	40CrMnMo7		
		1.2312	40CrMnNiMoS8.6	-1150	40CrMnNiMoS8-6		
		1.2316	X38CrMo16	-1100	X38CrMo16		
1.2738	45CrMnNiMo8.6.4	950-1150	45CrMnNiMo8-6-4				
M	Rost- und säurebe- ständiger Stahl, austenitisch	Stainless steel, austenitic	1.4301	X2CrNiMo17-12-2	500-950	X5CrNiMo18-10	
			1.4404	X6CrNiMoTi17-12-2		X2CrNiMo17-12-2	
			1.4571	X10CrNiMoTi18		X10CrNiMoTi18	
Rost- und säurebe- ständiger Stahl, martensitisch aushärtbar	Stainless steel, martensitic steel	1.2709	X3NiCoMoTi18-9-5	800-1000	X3NiCoMoTi18-9-5		
		1.4542	X5CrNiCuNb16-4		X5CrNiCuNb16-4		
		1.4568	X7CrNiAl17-7		X7CrNiAl17-7		
K	Grauguss	Grey cast iron	0.6025	GG25	100-400 (120-260 HB)	EN-GJI-250	
	Legierter Grauguss	Alloyed grey cast iron	0.6678	GGL-NiCr35 2	150-250 (160-230 HB)	EN-GJLA-XNiCr35-2	
	Sphäroguss	Nodular cast iron	0.7060 0.7070	GGG60 GGG70L	400-800 (120-310 HB)	EN-GJS-600-3 EN-GJS-700-2U	
	Temperguss	Malleable cast iron	0.8155	GTS55	350-700 (150-280 HB)	EN-GJMB-550-4	
N	Aluminium-Legierungen, kurzspanend	Aluminium alloys, short chipping	3.2581	G-AlSi12	-400	G-IGK-AlSi12	
	Aluminium-Legierungen, langspanend	Aluminium alloys, long chipping	3.3535 3.4365	AlMg3 AlZnMgCu1,5	-550	AlMg3 AlZnMgCu1,5	
	Kupfer-Legierungen, kurzspanend	Copper alloys, short chipping	2.0402	MS58	-500	CuZn40Pb2	
	Kupfer-Legierungen, langspanend	Copper alloys, long chipping	2.0320 2.0975	MS63 CuAl10Ni	300-500	CuZn37 CuAl10Fe5Ni5-C	
	Thermoplaste	Thermoplastics		PVC	40-70	PVC	
	Duroplaste	Duroplastics		Bakelit, Melamin	20-40	Bakelit, Melamin	
	Graphit	Graphite					
	Zirkonoxidkeramik	Zircon oxide ceramics					
S	Titan-Legierungen, mittelfest	Titanium alloys, medium strength	3.7115 3.7164	TiAl5Sn2,5 TiAl6V4	-950	TiAl5Sn2-5 TiAl6V4	
	Titan-Legierungen, hochfest	Titanium alloys, high strength	3.7174	TiAl6Sn2	900-1400	TiAl6V6Sn2	
	Nickelbasis-Legierungen, mittelfest	Nickel based alloys, medium strength	2.4670	NiCr12Al6MoNb	-950	NiCr12Al6MoNb	
	Nickelbasis-Legierungen, hochwarmfest	Heat resistant nickel based alloys, high strength	2.4668	NiCr19Fe19NbMo	900-1400	Inconel 718 NiCr19Fe19Nb5Mo3	
	Kobalt-Chrom-Legierung	Cobalt chromium alloys					
H	Hartguss	Chilled cast iron		Ni-hard, Ampco	300-600 HB	Ni-hard, Ampco	
	Gehärteter Stahl	Hardened steel			45-52 HRC		
					53-59 HRC		
					60-65 HRC		

Die angegebenen Schnittwerte sind Startwerte und müssen auf die vorhandenen Bedingungen abgestimmt werden.

Schnittgeschwindigkeit Cutting speed v_c (m/min)			Vorschub pro Zahn Feed per tooth f_z (mm/z.)					a_e Schruppen Roughing
			\varnothing 12	\varnothing 16	\varnothing 20	\varnothing 25	\varnothing 32	
WPR-AR LCPK30M	WPR-AR LCHK30M LCPK15M	WPR-AR LWNS30M	a_p max f_z max	a_p max f_z max	a_p max f_z max	a_p max f_z max	a_p max f_z max	
160-180	160-180		3,0 0,25	4,0 0,35	5,0 0,40	6,0 0,45	8,0 0,50	d x 0,10-0,12
160-180	160-180		3,0 0,25	4,0 0,35	5,0 0,40	6,0 0,45	8,0 0,50	
140-160	140-160		3,00 0,25	4,0 0,35	5,0 0,40	6,0 0,45	8,0 0,50	
140-160	140-160		3,0 0,25	4,0 0,35	5,0 0,40	6,0 0,45	8,0 0,50	
120-140	120-140		3,0 0,20	4,0 0,30	5,0 0,35	6,0 0,40	8,0 0,45	
140-160	140-160		3,0 0,20	4,0 0,30	5,0 0,35	6,0 0,40	8,0 0,45	
160-180			3,0 0,25	4,0 0,35	5,0 0,40	6,0 0,45	8,0 0,50	
160-200	160-200		3,0 0,25	4,0 0,35	5,0 0,40	6,0 0,45	8,0 0,50	
120-140	120-140		2,5 0,20	3,0 0,30	4,0 0,35	5,0 0,40	6,0 0,45	d x 0,08-0,10
100-120	100-120		2,5 0,20	3,0 0,30	4,0 0,35	5,0 0,40	6,0 0,45	
120-140	120-140		4,0 0,25	5,0 0,35	6,0 0,40	8,0 0,45	10,0 0,50	d x 0,10-0,12
120-140	120-140		4,0 0,25	5,0 0,35	6,0 0,40	8,0 0,45	10,0 0,50	
180-200	180-200		4,0 0,25	5,0 0,35	6,0 0,40	8,0 0,45	10,0 0,50	
160-180	160-180		4,0 0,25	5,0 0,35	6,0 0,40	8,0 0,45	10,0 0,50	
			4,0 0,25	5,0 0,35	6,0 0,40	8,0 0,45	10,0 0,50	d x 0,10-0,12
			4,0 0,25	5,0 0,35	6,0 0,40	8,0 0,45	10,0 0,50	
		250-300	4,0 0,25	5,0 0,35	6,0 0,40	8,0 0,45	10,0 0,50	
		200-250	4,0 0,25	5,0 0,35	6,0 0,40	8,0 0,45	10,0 0,50	
			4,0 0,25	5,0 0,35	6,0 0,40	8,0 0,45	10,0 0,50	
			4,0 0,25	5,0 0,35	6,0 0,40	8,0 0,45	10,0 0,50	
		80-100	1,5-2,0 0,25	2,5-3,0 0,35	3,0-3,5 0,40	3,0-4,0 0,45	4,0 0,50	d x 0,08-0,10
		60-80	1,5-2,0 0,25	2,5-3,0 0,35	3,0-3,5 0,40	3,0-4,0 0,45	4,0 0,50	
		60-80	1,5-2,0 0,25	2,5-3,0 0,35	3,0-3,5 0,40	3,0-4,0 0,45	4,0 0,50	
		40-60	1,5-2,0 0,25	2,5-3,0 0,35	3,0-3,5 0,40	3,0-4,0 0,45	4,0 0,50	
	100-120		1,0-1,5 0,20	2,0-2,5 0,30	2,5-3,0 0,35	3,0-3,5 0,40	3,5-4,0 0,45	d x 0,08-0,10
	160-180		1,5-2,0 0,25	2,5-3,0 0,35	3,0-3,5 0,40	3,0-4,0 0,45	4,0 0,50	d x 0,10-0,12
			1,5-2,0 0,25	2,5-3,0 0,35	3,0-3,5 0,40	3,0-4,0 0,45	4,0 0,50	d x 0,08-0,10

The cutting data indicated are starting values and must be adjusted to the prevailing conditions.

		Schneidstoffsorten Cutting materials Ident No.											Für Fräser For cutter Cat-No.										
N = Anzahl der Schneidkanten N = Number of cutting edges	ISO-Code	l	d	s	d ₁	r	LWP40M	LWNS30M	LWNS10M	LWNS33M	LCP40M	LCPK30M		LCPK10M	LCPK25M	LCPK15M	LCKP10M	LCHK10M	LCH33M	LCN10M	LDN10M		
 N = 2	WPR 06 N	-	6	1,6	2,5	3									7214248	7108571						EBG R 06	
	WPR 08 N	-	8	2	3	4	6123058		6123047		9078153				7214252	7108479			7108486			EBG R 08	
	WPR 10 N	-	10	2,5	4	5	6123180		6123172		9078154				7214253	7108490			7108491			EBG R 10	
	WPR 12 N	-	12	2,5	5	6	6123159		6123153		9078155				7214254	7108498			7108499			EBG R 12	
	WPR 16 N	-	16	3	5	8	6123140		6123135		6131686				7214255	7108501			7108502			EBG R 16	
	WPR 20 N	-	20	3	5	10	6123122		6123117		9078156				7214256	7108503			7108505			EBG R 20	
	WPR 25 N	-	25	4	6	12,5	6180175		6123099		9078157				7214257	7108508			7108509			EBG R 25	
	WPR 30 N	-	30	5	6	15	6123065		6200388						7214258	7108512						EBG R 30	
	WPR 32 N	-	32	5	8	16	6180254		6123076		9078158				7214259	7108561			7108562			EBG R 32	
							■				■			■	■			□				P	
															□	□							M
																							K
								■															N
															□	□							S
															□	□			■				H

■ = Hauptanwendung First choice
 □ = Nebenanwendung Alternative

Sortenbeschreibung/-bezeichnung und ISO-Code ab Seite 424/477
 Description/Designation of grades and ISO-Code starting page 424/477

Alle WPR-, WPV- und WPB-Wendepplatten sind in der Sorte LCN10M (diamantbeschichtet) oder PKD/CBN-bestückt auf Anfrage lieferbar.
 All WPR, WPV and WPB inserts are available in grade LCN10M (diamond coated) or PCD/CBN tipped.

		Schneidstoffsorten Cutting materials Ident No.											Für Fräser For cutter Cat.-No.					
		LWP40M	LWNS30M	LWNS10M	LWNS33M	LCP40M	LCPK30M	LCPK10M	LCPK25M	LCPK15M	LCKP10M	LCHK10M		LCH33M	LCN10M	LDN10M		
N = Anzahl der Schneidkanten N = Number of cutting edges	ISO-Code	l	d	s	d ₁	r												
<p>N = 2</p>	WPR 08 CF	-	8	2	3	4	6122958		6122963		9078159	6132336					EBG R 08	
	WPR 10 CF	-	10	2,5	4	5	6123051		6123043		9078160	6132337					EBG R 10	
	WPR 12 CF	-	12	2,5	5	6	6123030		6123024		9078161	6132338					EBG R 12	
	WPR 16 CF	-	16	3	5	8	6123029		6123006		6131685	6131617					EBG R 16	
	WPR 20 CF	-	20	3	5	10	6123011		6123004		9078163	6132339					EBG R 20	
	WPR 25 CF	-	25	4	6	12,5	6180001		6122984		9077244	6132341					EBG R 25	
	WPR 32 CF	-	32	5	8	16			6122979		9078164	6132342					EBG R 32	
							■				■						P	
												□						M
													■					K
								■										N
																		S
																		H

■ = Hauptanwendung First choice
□ = Nebenanwendung Alternative

Sortenbeschreibung/-bezeichnung und ISO-Code ab Seite 424/477
Description/Designation of grades and ISO-Code starting page 424/477

Alle WPR-, WPV- und WPB-Wendepplatten sind in der Sorte LCN10M (diamantbeschichtet) oder PKD/CBN-bestückt auf Anfrage lieferbar.
All WPR, WPV and WPB inserts are available in grade LCN10M (diamond coated) or PCD/CBN tipped.

Fräser mit Wendeschneidplatten
Milling with indexable inserts

Schnittwertempfehlungen für Wechsellplatte WPR-N/CF Schlichten
Cutting data recommendations for indexable insert WPR-N/CF Finishing

	Werkstoff	Material	Werkstoff-Nr. Material No.	DIN Bezeichnung Alt DIN Description Old	R _m /UTS (N/mm ²)	DIN Bezeichnung Neu DIN Description New
P	Unlegierter Baustahl + Automatenstahl	Plain carbon steel + free cutting steel	1.0570	St52-3	-700	S355J2G3
			1.1730	C45	-800	C45U
			1.0715	9SMn28	-700	11SMn30
			1.1191	Ck45	500-950	C45E
			1.7219	26CrMo4	500-950	26CrMo4-2
	Vergütungsstahl, mittelfest	Heat-treatment steel, medium strength	1.7225	42CrMo4	500-950	42CrMo4
	Stahlguss	Cast steel	1.8159	51CrV4		51CrV4
			1.0416	GS40	-950	GS40
	Einsatzstahl	Case hardening steel	1.7131	16MnCr5	-950	16MnCr5
	Rost- und säurebe- ständiger Stahl, ferritisch, martensitisch	Stainless steel, ferritic, martensitic	1.4006	X10Cr13	500-950	X12Cr13
			1.4104	X12CrMoS17		X14CrMoS17
			1.4122	X35CrMo17		X39CrMo17-1
	Vergütungsstahl, hochfest	Heat-treatment steel, high strength	1.7225	42CrMo4	950-1400	42CrMo4
	Nitrierstahl, vergütet	Nitriding steel, heat treated	1.6580	30CrNiMo8		30CrNiMo8
	Werkzeugstahl	Tool steel	1.8504	34CrAl6	950-1400	34CrAl6
1.2344			X40CrMoV5.1	-900	X40CrMoV5-1	
		1.2343	X38CrMoV5 1	950-1400	X37CrMoV5-1	
		1.2379	X155CrVMo12 1	-950	X153CrMoV12-1	
		1.2358	60CrMoV18-5	850-1000	60CrMoV18-5	
		1.2080	X210Cr12	950-1400	X210Cr12	
		1.2714	55NiCrMoV7	1100-1350	55NiCrMoV7	
		1.2311	40CrMnMo7	-1100	40CrMnMo7	
		1.2312	40CrMnNiMoS8.6	-1150	40CrMnNiMoS8-6	
		1.2316	X38CrMo16	-1100	X38CrMo16	
		1.2738	45CrMnNiMo8.6.4	950-1150	45CrMnNiMo8-6-4	
M	Rost- und säurebe- ständiger Stahl, austenitisch	Stainless steel, austenitic	1.4301	X2CrNiMo17-12-2	500-950	X5CrNiMo18-10
			1.4404	X6CrNiMoTi17-12-2		X2CrNiMo17-12-2
			1.4571	X10CrNiMoTi18		X10CrNiMoTi18
Rost- und säurebe- ständiger Stahl, martensitisch aushärtbar	Stainless steel, martensitic steel	1.2709	X3NiCoMoTi18-9-5	800-1000	X3NiCoMoTi18-9-5	
		1.4542	X5CrNiCuNb16-4		X5CrNiCuNb16-4	
		1.4568	X7CrNiAl17-7		X7CrNiAl17-7	
K	Grauguss	Grey cast iron	0.6025	GG25	100-400 (120-260 HB)	EN-GJL-250
	Legierter Grauguss	Alloyed grey cast iron	0.6678	GGL-NiCr35 2	150-250 (160-230 HB)	EN-GJLA-XNiCr35-2
	Sphäroguss	Nodular cast iron	0.7060	GGG60	400-800	EN-GJS-600-3
			0.7070	GGG70L	(120-310 HB)	EN-GJS-700-2U
Temperguss	Malleable cast iron	0.8155	GTS55	350-700 (150-280 HB)	EN-GJMB-550-4	
N	Aluminium-Legierungen, kurzspanend	Aluminium alloys, short chipping	3.2581	G-AlSi12	-400	G-IGK-AlSi12
	Aluminium-Legierungen, langspanend	Aluminium alloys, long chipping	3.3535	AlMg3	-550	AlMg3
	Kupfer-Legierungen, kurzspanend	Copper alloys, short chipping	3.4365	AlZnMgCu1,5		AlZnMgCu1,5
	Kupfer-Legierungen, langspanend	Copper alloys, long chipping	2.0402	MS58	-500	CuZn40Pb2
	Thermoplaste	Thermoplastics	2.0320	MS63	300-500	CuZn37
			2.0975	CuAl10Ni		CuAl10Fe5Ni5-C
	Duroplaste	Duroplastics		PVC	40-70	PVC
				Bakelit, Melamin	20-40	Bakelit, Melamin
Graphit	Graphite					
	Zirkonoxidkeramik	Zircon oxide ceramics				
S	Titan-Legierungen, mittelfest	Titanium alloys, medium strength	3.7115	TiAl5Sn2,5	-950	TiAl5Sn2-5
			3.7164	TiAl6V4		Ti6AlV4
	Titan-Legierungen, hochfest	Titanium alloys, high strength	3.7174	TiAl6Sn2	900-1400	TiAl6V6Sn2
	Nickelbasis-Legierungen, mittelfest	Nickel based alloys, medium strength	2.4670	NiCr12Al6MoNb	-950	NiCr12Al6MoNb
	Nickelbasis-Legierungen, hochwarmfest	Heat resistant nickel based alloys, high strength	2.4668	NiCr19Fe19NbMo	900-1400	Inconel 718 NiCr19Fe19Nb5Mo3
Kobalt-Chrom-Legierung	Cobalt chromium alloys					
H	Hartguss	Chilled cast iron		Ni-hard, Ampco	300-600 HB	Ni-hard, Ampco
	Gehärteter Stahl	Hardened steel			45-52 HRC	
					53-59 HRC	
				60-65 HRC		

Die angegebenen Schnittwerte sind Startwerte und müssen auf die vorhandenen Bedingungen abgestimmt werden.

Schnittgeschwindigkeit Cutting speed v_c (m/min)				Vorschub pro Zahn Feed per tooth f_z (mm/z.)									a_e Schichten Finishing
				$\varnothing 6$	$\varnothing 8$	$\varnothing 10$	$\varnothing 12$	$\varnothing 16$	$\varnothing 20$	$\varnothing 25$	$\varnothing 32$		
WPR-N/CF LWP40M	WPR-N/CF LCP40M	WPR-N/CF LCKP10M LCPK15M	WPR-N LCM33M	a_p max f_z max	a_p max f_z max	a_p max f_z max	a_p max f_z max	a_p max f_z max	a_p max f_z max	a_p max f_z max	a_p max f_z max	a_p max f_z max	
		280-300	280-300	0,10 0,10	0,15 0,15	0,15 0,20	0,25 0,25	0,30 0,30	0,35 0,40	0,40 0,40	0,45 0,50	d x 0,02	
		280-300	280-300	0,10 0,10	0,15 0,15	0,15 0,20	0,25 0,25	0,30 0,30	0,35 0,40	0,40 0,40	0,45 0,50		
				0,10 0,10	0,15 0,15	0,15 0,20	0,25 0,25	0,30 0,30	0,35 0,40	0,40 0,40	0,45 0,50		
		220-240	220-240	0,10 0,10	0,15 0,15	0,15 0,20	0,25 0,25	0,30 0,30	0,35 0,40	0,40 0,40	0,45 0,50		
		240-260	240-260	0,10 0,10	0,15 0,15	0,15 0,20	0,25 0,25	0,30 0,30	0,35 0,40	0,40 0,40	0,45 0,50		
		280-300	280-300	0,10 0,10	0,15 0,15	0,15 0,20	0,25 0,25	0,30 0,30	0,35 0,40	0,40 0,40	0,45 0,50		
		200-220	200-220	0,10 0,10	0,15 0,15	0,15 0,20	0,25 0,25	0,30 0,30	0,35 0,40	0,40 0,40	0,45 0,50		
		220-240	220-240	0,10 0,10	0,15 0,15	0,15 0,20	0,25 0,25	0,30 0,30	0,35 0,40	0,40 0,40	0,45 0,50		
		280-300	280-300	0,10 0,10	0,15 0,15	0,15 0,20	0,25 0,25	0,30 0,30	0,35 0,40	0,40 0,40	0,45 0,50		
		280-320	280-320	0,10 0,10	0,15 0,15	0,15 0,20	0,25 0,25	0,30 0,30	0,35 0,40	0,40 0,40	0,45 0,50		
		180-200	180-200	0,10 0,10	0,15 0,15	0,15 0,20	0,25 0,25	0,30 0,30	0,35 0,40	0,40 0,40	0,45 0,50	d x 0,02	
		160-180	160-180	0,10 0,10	0,15 0,15	0,15 0,20	0,25 0,25	0,30 0,30	0,35 0,40	0,40 0,40	0,45 0,50		
		280-300	280-300	0,10 0,10	0,15 0,15	0,15 0,20	0,25 0,25	0,30 0,30	0,35 0,40	0,40 0,40	0,45 0,50	d x 0,02	
		260-280	260-280	0,10 0,10	0,15 0,15	0,15 0,20	0,25 0,25	0,30 0,30	0,35 0,40	0,40 0,40	0,45 0,50		
		300-350	300-350	0,10 0,10	0,15 0,15	0,15 0,20	0,25 0,25	0,30 0,30	0,35 0,40	0,40 0,40	0,45 0,50		
		240-260	240-260	0,10 0,10	0,15 0,15	0,15 0,20	0,25 0,25	0,30 0,30	0,35 0,40	0,40 0,40	0,45 0,50		
												d x 0,02	
		120-140	120-140	0,10 0,08	0,10 0,08	0,15 1,00	0,10 0,18	0,15 0,20	0,20 0,25	0,25 0,25	0,30 0,30	d x 0,02	
		240-260	240-260	0,10 0,10	0,15 0,15	0,15 0,20	0,25 0,25	0,30 0,30	0,35 0,40	0,40 0,40	0,45 0,50		
		200-220	200-220	0,10 0,10	0,15 0,15	0,15 0,20	0,25 0,25	0,30 0,30	0,35 0,40	0,40 0,40	0,45 0,50		
		120-140	120-140	0,10 0,08	0,10 0,08	0,15 1,00	0,10 0,18	0,15 0,20	0,20 0,25	0,25 0,25	0,30 0,30		

Fräsen mit Wendeschneidplatten
Milling with indexable inserts

The cutting data indicated are starting values and must be adjusted to the prevailing conditions.

Schnittwertempfehlungen für Wechsellatte WPR-N/CF Schruppen Cutting data recommendations for indexable insert WPR-N/CF Roughing

	Werkstoff	Material	Werkstoff-Nr. Material No.	DIN Bezeichnung Alt DIN Description Old	R _m /UTS (N/mm ²)	DIN Bezeichnung Neu DIN Description New
P	Unlegierter Baustahl + Automatenstahl	Plain carbon steel + free cutting steel	1.0570	St52-3	-700	S355J2G3
			1.1730	C45	-800	C45U
			1.0715	9SMn28	-700	11SMn30
	Vergütungsstahl, mittelfest	Heat-treatment steel, medium strength	1.1191	Ck45	500-950	C45E
			1.7219	26CrMo4	500-950	26CrMo4-2
	Stahlguss	Cast steel	1.7225	42CrMo4	500-950	42CrMo4
			1.8159	51CrV4	-950	51CrV4
	Einsatzstahl	Case hardening steel	1.0416	GS40	-950	GS40
			1.7131	16MnCr5	-950	16MnCr5
	Rost- und säurebe- ständiger Stahl, ferritisch, martensitisch	Stainless steel, ferritic, martensitic	1.4006	X10Cr13	500-950	X12Cr13
			1.4104	X12CrMoS17	500-950	X14CrMoS17
			1.4122	X35CrMo17	500-950	X39CrMo17-1
	Vergütungsstahl, hochfest	Heat-treatment steel, high strength	1.7225	42CrMo4	950-1400	42CrMo4
			1.6580	30CrNiMo8	950-1400	30CrNiMo8
	Nitrierstahl, vergütet	Nitriding steel, heat treated	1.8504	34CrAl6	950-1400	34CrAl6
			1.2344	X40CrMoV5.1	-900	X40CrMoV5-1
Werkzeugstahl	Tool steel	1.2343	X38CrMoV5 1	950-1400	X37CrMoV5-1	
		1.2379	X155CrVMo12 1	-950	X153CrMoV12-1	
		1.2358	60CrMoV18-5	850-1000	60CrMoV18-5	
		1.2080	X210Cr12	950-1400	X210Cr12	
		1.2714	55NiCrMoV7	1100-1350	55NiCrMoV7	
		1.2311	40CrMnMo7	-1100	40CrMnMo7	
		1.2312	40CrMnNiMoS8.6	-1150	40CrMnNiMoS8-6	
		1.2316	X38CrMo16	-1100	X38CrMo16	
		1.2738	45CrMnNiMo8.6.4	950-1150	45CrMnNiMo8-6-4	
M	Rost- und säurebe- ständiger Stahl, austenitisch	Stainless steel, austenitic	1.4301	X2CrNiMo17-12-2	500-950	X5CrNiMo18-10
			1.4404	X6CrNiMoTi17-12-2	500-950	X2CrNiMo17-12-2
			1.4571	X10CrNiMoTi18	500-950	X10CrNiMoTi18
Rost- und säurebe- ständiger Stahl, martensitisch aushärtbar	Stainless steel, martensitic steel	Stainless steel, martensitic steel	1.2709	X3NiCoMoTi18-9-5	800-1000	X3NiCoMoTi18-9-5
			1.4542	X5CrNiCuNb16-4	800-1000	X5CrNiCuNb16-4
			1.4568	X7CrNiAl17-7	800-1000	X7CrNiAl17-7
K	Grauguss	Grey cast iron	0.6025	GG25	100-400 (120-260 HB)	EN-GJL-250
			0.6678	GGL-NiCr35 2	150-250 (160-230 HB)	EN-GJLA-XNiCr35-2
			0.7060	GGG60	400-800	EN-GJS-600-3
			0.7070	GGG70L	(120-310 HB)	EN-GJS-700-2U
Sphäroguss	Nodular cast iron	0.7060	GGG60	400-800	EN-GJS-600-3	
		0.7070	GGG70L	(120-310 HB)	EN-GJS-700-2U	
Temperguss	Malleable cast iron	0.8155	GTS55	350-700 (150-280 HB)	EN-GJMB-550-4	
		0.8155	GTS55	350-700 (150-280 HB)	EN-GJMB-550-4	
N	Aluminium-Legierungen, kurzspanend	Aluminium alloys, short chipping	3.2581	G-AlSi12	-400	G-IGK-AlSi12
			3.3535	AlMg3	-550	AlMg3
	Aluminium-Legierungen, langspanend	Aluminium alloys, long chipping	3.4365	AlZnMgCu1,5	-550	AlZnMgCu1,5
			2.0402	MS58	-500	CuZn40Pb2
	Kupfer-Legierungen, kurzspanend	Copper alloys, short chipping	2.0320	MS63	300-500	CuZn37
			2.0975	CuAl10Ni	300-500	CuAl10Fe5Ni5-C
	Thermoplaste	Thermoplastics		PVC	40-70	PVC
				PVC	40-70	PVC
Duroplaste	Duroplastics		Bakelit, Melamin	20-40	Bakelit, Melamin	
			Bakelit, Melamin	20-40	Bakelit, Melamin	
Graphit	Graphite					
Zirkonoxidkeramik	Zircon oxide ceramics					
S	Titan-Legierungen, mittelfest	Titanium alloys, medium strength	3.7115	TiAl5Sn2,5	-950	TiAl5Sn2-5
			3.7164	TiAl6V4	-950	Ti6AlV4
	Titan-Legierungen, hochfest	Titanium alloys, high strength	3.7174	TiAl6Sn2	900-1400	TiAl6V6Sn2
			2.4670	NiCr12Al6MoNb	-950	NiCr12Al6MoNb
	Nickelbasis-Legierungen, mittelfest	Nickel based alloys, medium strength	2.4668	NiCr19Fe19NbMo	900-1400	Inconel 718 NiCr19Fe19Nb5Mo3
Nickelbasis-Legierungen, hochwarmfest	Heat resistant nickel based alloys, high strength	2.4668	NiCr19Fe19NbMo	900-1400	Inconel 718 NiCr19Fe19Nb5Mo3	
Kobalt-Chrom-Legierung	Cobalt chromium alloys					
H	Hartguss	Chilled cast iron		Ni-hard, Ampco	300-600 HB	Ni-hard, Ampco
Gehärteter Stahl	Hardened steel				45-52 HRC	
					53-59 HRC	
					60-65 HRC	

Die angegebenen Schnittwerte sind Startwerte und müssen auf die vorhandenen Bedingungen abgestimmt werden.

Schnittgeschwindigkeit Cutting speed v_c (m/min)			Vorschub pro Zahn Feed per tooth f_z (mm/z.)									a_e Schruppen Roughing
			$\varnothing 6$	$\varnothing 8$	$\varnothing 10$	$\varnothing 12$	$\varnothing 16$	$\varnothing 20$	$\varnothing 25$	$\varnothing 30$	$\varnothing 32$	
WPR-N/CF LCP40M	WPR-N/CF LCKP10M LCPK15M	WPR-N/CF LWNS10M	a_p max f_z max	a_p max f_z max	a_p max f_z max	a_p max f_z max	a_p max f_z max	a_p max f_z max	a_p max f_z max	a_p max f_z max	a_p max f_z max	a_p max f_z max
180-200	200-220		0,50-1,00 0,08-0,12	1,00-1,50 0,10-0,15	1,50-2,0 0,15-0,18	2,00-2,50 0,20-0,25	3,00 0,20-0,30	3,00 0,25-0,35	3,50 0,30-0,40	3,50 0,30-0,40	4,00 0,35-0,45	d x 0,05-0,08
180-200	200-220		0,50-1,00 0,08-0,12	1,00-1,50 0,10-0,15	1,50-2,0 0,15-0,18	2,00-2,50 0,20-0,25	3,00 0,20-0,30	3,00 0,25-0,35	3,50 0,30-0,40	3,50 0,30-0,40	4,00 0,35-0,45	
180-200	200-220		0,50-1,00 0,08-0,12	1,00-1,50 0,10-0,15	1,50-2,0 0,15-0,18	2,00-2,50 0,20-0,25	3,00 0,20-0,30	3,00 0,25-0,35	3,50 0,30-0,40	3,50 0,30-0,40	4,00 0,35-0,45	
180-200	200-220		0,50-1,00 0,08-0,12	1,00-1,50 0,10-0,15	1,50-2,0 0,15-0,18	2,00-2,50 0,20-0,25	3,00 0,20-0,30	3,00 0,25-0,35	3,50 0,30-0,40	3,50 0,30-0,40	4,00 0,35-0,45	
160-180	160-180		0,50-1,00 0,08-0,12	1,00-1,50 0,10-0,15	1,50-2,0 0,15-0,18	2,00-2,50 0,20-0,25	3,00 0,20-0,30	3,00 0,25-0,35	3,50 0,30-0,40	3,50 0,30-0,40	4,00 0,35-0,45	
180-200	200-220		0,50-1,00 0,08-0,12	1,00-1,50 0,10-0,15	1,50-2,0 0,15-0,18	2,00-2,50 0,20-0,25	3,00 0,20-0,30	3,00 0,25-0,35	3,50 0,30-0,40	3,50 0,30-0,40	4,00 0,35-0,45	
140-160	140-160		0,50-1,00 0,08-0,12	1,00-1,50 0,10-0,15	1,50-2,0 0,15-0,18	2,00-2,50 0,20-0,25	3,00 0,20-0,30	3,00 0,25-0,35	3,50 0,30-0,40	3,50 0,30-0,40	4,00 0,35-0,45	
160-180	160-180		0,50-1,00 0,08-0,12	1,00-1,50 0,10-0,15	1,50-2,0 0,15-0,18	2,00-2,50 0,20-0,25	3,00 0,20-0,30	3,00 0,25-0,35	3,50 0,30-0,40	3,50 0,30-0,40	4,00 0,35-0,45	
180-200	200-220		0,50-1,00 0,08-0,12	1,00-1,50 0,10-0,15	1,50-2,0 0,15-0,18	2,00-2,50 0,20-0,25	3,00 0,20-0,30	3,00 0,25-0,35	3,50 0,30-0,40	3,50 0,30-0,40	4,00 0,35-0,45	
200-220	200-220		0,50-1,00 0,08-0,12	1,00-1,50 0,10-0,15	1,50-2,0 0,15-0,18	2,00-2,50 0,20-0,25	3,00 0,20-0,30	3,00 0,25-0,35	3,50 0,30-0,40	3,50 0,30-0,40	4,00 0,35-0,45	
140-160	140-160		0,50-1,00 0,08-0,12	1,00-1,50 0,10-0,15	1,50-2,0 0,15-0,18	2,00-2,50 0,20-0,25	3,00 0,20-0,30	3,00 0,25-0,35	3,50 0,30-0,40	3,50 0,30-0,40	4,00 0,35-0,45	d x 0,05-0,08
120-140	120-140		0,50-1,00 0,08-0,12	1,00-1,50 0,10-0,15	1,50-2,0 0,15-0,18	2,00-2,50 0,20-0,25	3,00 0,20-0,30	3,00 0,25-0,35	3,50 0,30-0,40	3,50 0,30-0,40	4,00 0,35-0,45	
160-180	180-200		0,50-1,00 0,08-0,12	1,00-1,50 0,10-0,15	1,50-2,0 0,15-0,18	2,00-2,50 0,20-0,25	3,00 0,20-0,30	3,00 0,25-0,35	3,50 0,30-0,40	3,50 0,30-0,40	4,00 0,35-0,45	d x 0,05-0,08
160-180	160-180		0,50-1,00 0,08-0,12	1,00-1,50 0,10-0,15	1,50-2,0 0,15-0,18	2,00-2,50 0,20-0,25	3,00 0,20-0,30	3,00 0,25-0,35	3,50 0,30-0,40	3,50 0,30-0,40	4,00 0,35-0,45	
180-200	200-220		0,50-1,00 0,08-0,12	1,00-1,50 0,10-0,15	1,50-2,0 0,15-0,18	2,00-2,50 0,20-0,25	3,00 0,20-0,30	3,00 0,25-0,35	3,50 0,30-0,40	3,50 0,30-0,40	4,00 0,35-0,45	
160-180	180-200		0,50-1,00 0,08-0,12	1,00-1,50 0,10-0,15	1,50-2,0 0,15-0,18	2,00-2,50 0,20-0,25	3,00 0,20-0,30	3,00 0,25-0,35	3,50 0,30-0,40	3,50 0,30-0,40	4,00 0,35-0,45	
		240-300	0,50-1,00 0,08-0,12	1,00-1,50 0,10-0,15	1,50-2,0 0,15-0,18	2,00-2,50 0,20-0,25	3,00 0,20-0,30	3,00 0,25-0,35	3,50 0,30-0,40	3,50 0,30-0,40	4,00 0,35-0,45	d x 0,05-0,08
200-220	220-240	240-300	0,50-1,00 0,08-0,12	1,00-1,50 0,10-0,15	1,50-2,0 0,15-0,18	2,00-2,50 0,20-0,25	3,00 0,20-0,30	3,00 0,25-0,35	3,50 0,30-0,40	3,50 0,30-0,40	4,00 0,35-0,45	
180-200	200-220	200-220	0,50-1,00 0,08-0,12	1,00-1,50 0,10-0,15	1,50-2,0 0,15-0,18	2,00-2,50 0,20-0,25	3,00 0,20-0,30	3,00 0,25-0,35	3,50 0,30-0,40	3,50 0,30-0,40	4,00 0,35-0,45	
												d x 0,05-0,08
80-100			0,30-0,50 0,08-0,10	0,30-0,50 0,10-0,12	0,30-0,50 0,10-0,12	0,50-0,80 0,10-0,15	0,50-1,00 0,18-0,20	0,50-1,00 0,20-0,25	0,80-1,20 0,25-0,30	0,80-1,20 0,25-0,30	1,20-1,80 0,25-0,30	
80-100			0,30-0,50 0,08-0,10	0,30-0,50 0,10-0,12	0,30-0,50 0,10-0,12	0,50-0,80 0,10-0,15	0,50-1,00 0,18-0,20	0,50-1,00 0,20-0,25	0,80-1,20 0,25-0,30	0,80-1,20 0,25-0,30	1,20-1,80 0,25-0,30	
120-140	120-140		0,30-0,50 0,08-0,10	0,30-0,50 0,10-0,12	0,30-0,50 0,10-0,12	0,50-0,80 0,10-0,15	0,50-1,00 0,18-0,20	0,50-1,00 0,20-0,25	0,80-1,20 0,25-0,30	0,80-1,20 0,25-0,30	1,20-1,80 0,25-0,30	d x 0,05-0,08
140-160	140-160		0,50-1,00 0,08-0,12	1,00-1,50 0,10-0,15	1,50-2,0 0,15-0,18	2,00-2,50 0,20-0,25	3,00 0,20-0,30	3,00 0,25-0,35	3,50 0,30-0,40	3,50 0,30-0,40	4,00 0,35-0,45	
	120-140		0,30-0,50 0,08-0,10	0,30-0,50 0,10-0,12	0,30-0,50 0,10-0,12	0,50-0,80 0,10-0,15	0,50-1,00 0,18-0,20	0,50-1,00 0,20-0,25	0,80-1,20 0,25-0,30	0,80-1,20 0,25-0,30	1,20-1,80 0,25-0,30	
	100-120											

Fräsen mit Wertschneidplatten
Milling with indexable inserts

The cutting data indicated are starting values and must be adjusted to the prevailing conditions.

		Schneidstoffsorten Cutting materials Ident No.											Für Fräser For cutter Cat-No.					
		LWP40M	LWNS30M	LWNS10M	LWNS33M	LCP40M	LCPK30M	LCPK10M	LCPK25M	LCPK15M	LCKP10M	LCHK10M		LCH33M	LCN10M	LDN10M		
N = Anzahl der Schneidkanten N = Number of cutting edges	ISO-Code	l	d	s	d ₁	r												
 N = 2	WPR 06 DN	-	6	1,6	2,5	3				6132363							9079232	EBG R 06
	WPR 08 DN	-	8	2	3	4			6131629	9074571							9074406	EBG R 08
	WPR 10 DN	-	10	2,5	4	5			6131302	9074574							6132330	EBG R 10
	WPR 12 DN	-	12	2,5	5	6			6131303	9074575							6132329	EBG R 12
	WPR 16 DN	-	16	3	5	8			6131304	9074576							9074409	EBG R 16
	WPR 20 DN	-	20	3	5	10			6131305	9074577							6132089	EBG R 20
	WPR 25 DN	-	25	4	6	12,5			6131306	9074578								EBG R 25
	WPR 32 DN	-	32	5	8	16			6131307	9074580								EBG R 32

■ = Hauptanwendung First choice
 □ = Nebenanwendung Alternative

Sortenbeschreibung/-bezeichnung und ISO-Code ab Seite 424/477
 Description/Designation of grades and ISO-Code starting page 424/477

Alle WPR-, WPV- und WPB-Wendepplatten sind in der Sorte LCN10M (diamantbeschichtet) oder PKD/CBN-bestückt auf Anfrage lieferbar.
 All WPR, WPV and WPB inserts are available in grade LCN10M (diamond coated) or PCD/CBN tipped.

																		P
																		M
																		K
																		N
																		S
																		H

Fräsen mit Wendeschneidplatten
Milling with indexable inserts

Schnittwertempfehlungen für Wechsellatte WPR-D Schlichten

Cutting data recommendations for indexable insert WPR-D Finishing

	Werkstoff	Material	Werkstoff-Nr. Material No.	DIN Bezeichnung Alt DIN Description Old	R _m /UTS (N/mm ²)	DIN Bezeichnung Neu DIN Description New
P	Unlegierter Baustahl + Automatenstahl	Plain carbon steel + free cutting steel	1.0570	St52-3	-700	S355J2G3
			1.1730	C45	-800	C45U
			1.0715	9SMn28	-700	11SMn30
			1.1191 1.7219	Ck45 26CrMo4	500-950	C45E 26CrMo4-2
	Vergütungsstahl, mittelfest	Heat-treatment steel, medium strength	1.7225 1.8159	42CrMo4 51CrV4	500-950	42CrMo4 51CrV4
	Stahlguss	Cast steel	1.0416	GS40	-950	GS40
	Einsatzstahl	Case hardening steel	1.7131	16MnCr5	-950	16MnCr5
	Rost- und säurebe- ständiger Stahl, ferritisch, martensitisch	Stainless steel, ferritic, martensitic	1.4006 1.4104 1.4122	X10Cr13 X12CrMoS17 X35CrMo17	500-950	X12Cr13 X14CrMoS17 X39CrMo17-1
	Vergütungsstahl, hochfest	Heat-treatment steel, high strength	1.7225 1.6580	42CrMo4 30CrNiMo8	950-1400	42CrMo4 30CrNiMo8
	Nitrierstahl, vergütet	Nitriding steel, heat treated	1.8504 1.2344	34CrAl6 X40CrMoV5.1	950-1400 -900	34CrAl6 X40CrMoV5-1
	Werkzeugstahl	Tool steel	1.2343	X38CrMoV5 1	950-1400	X37CrMoV5-1
			1.2379	X155CrVMo12 1	-950	X153CrMoV12-1
			1.2358	60CrMoV18-5	850-1000	60CrMoV18-5
1.2080			X210Cr12	950-1400	X210Cr12	
1.2714			55NiCrMoV7	1100-1350	55NiCrMoV7	
1.2311			40CrMnMo7	-1100	40CrMnMo7	
1.2312			40CrMnNiMoS8.6	-1150	40CrMnNiMoS8-6	
1.2316 1.2738			X38CrMo16 45CrMnNiMo8.6.4	-1100 950-1150	X38CrMo16 45CrMnNiMo8-6-4	
M	Rost- und säurebe- ständiger Stahl, austenitisch	Stainless steel, austenitic	1.4301	X2CrNiMo17-12-2	500-950	X5CrNiMo18-10
			1.4404	X6CrNiMoTi17-12-2		X2CrNiMo17-12-2
			1.4571	X10CrNiMoTi18		X10CrNiMoTi18
Rost- und säurebe- ständiger Stahl, martensitisch aushärtbar	Stainless steel, martensitic steel	1.2709	X3NiCoMoTi18-9-5	800-1000	X3NiCoMoTi18-9-5	
		1.4542	X5CrNiCuNb16-4		X5CrNiCuNb16-4	
		1.4568	X7CrNiAl17-7		X7CrNiAl17-7	
K	Grauguss	Grey cast iron	0.6025	GG25	100-400 (120-260 HB)	EN-GJI-250
			0.6678	GGL-NiCr35 2	150-250 (160-230 HB)	EN-GJLA-XNiCr35-2
	Sphäroguss	Nodular cast iron	0.7060	GGG60	400-800	EN-GJS-600-3
			0.7070	GGG70L	(120-310 HB)	EN-GJS-700-2U
Temperguss	Malleable cast iron	0.8155	GTS55	350-700 (150-280 HB)	EN-GJMB-550-4	
N	Aluminium-Legierungen, kurzspanend	Aluminium alloys, short chipping	3.2581	G-AlSi12	-400	G-IGK-AlSi12
	Aluminium-Legierungen, langspanend	Aluminium alloys, long chipping	3.3535 3.4365	AlMg3 AlZnMgCu1,5	-550	AlMg3 AlZnMgCu1,5
	Kupfer-Legierungen, kurzspanend	Copper alloys, short chipping	2.0402	MS58	-500	CuZn40Pb2
	Kupfer-Legierungen, langspanend	Copper alloys, long chipping	2.0320 2.0975	MS63 CuAl10Ni	300-500	CuZn37 CuAl10Fe5Ni5-C
	Thermoplaste	Thermoplastics		PVC	40-70	PVC
	Duroplaste	Duroplastics		Bakelit, Melamin	20-40	Bakelit, Melamin
	Graphit	Graphite				
	Zirkonoxidkeramik	Zircon oxide ceramics				
S	Titan-Legierungen, mittelfest	Titanium alloys, medium strength	3.7115 3.7164	TiAl5Sn2,5 TiAl6V4	-950	TiAl5Sn2-5 TiAl6V4
	Titan-Legierungen, hochfest	Titanium alloys, high strength	3.7174	TiAl6Sn2	900-1400	TiAl6V6Sn2
	Nickelbasis-Legierungen, mittelfest	Nickel based alloys, medium strength	2.4670	NiCr12Al6MoNb	-950	NiCr12Al6MoNb
	Nickelbasis-Legierungen, hochwarmfest	Heat resistant nickel based alloys, high strength	2.4668	NiCr19Fe19NbMo	900-1400	Inconel 718 NiCr19Fe19Nb5Mo3
	Kobalt-Chrom-Legierung	Cobalt chromium alloys				
H	Hartguss	Chilled cast iron		Ni-hard, Ampco	300-600 HB	Ni-hard, Ampco
	Gehärteter Stahl	Hardened steel			45-52 HRC	
					53-59 HRC	
				60-65 HRC		

Die angegebenen Schnittwerte sind Startwerte und müssen auf die vorhandenen Bedingungen abgestimmt werden.

Schnittgeschwindigkeit Cutting speed v_c (m/min)		Vorschub pro Zahn Feed per tooth f_z (mm/z.)								a_e Schlichten Finishing
		$\varnothing 6$	$\varnothing 8$	$\varnothing 10$	$\varnothing 12$	$\varnothing 16$	$\varnothing 20$	$\varnothing 25$	$\varnothing 32$	
WPR-D LCKP10M LCPK15M	WPR-D LCH33M	a_p max f_z max	a_p max f_z max	a_p max f_z max	a_p max f_z max	a_p max f_z max	a_p max f_z max	a_p max f_z max	a_p max f_z max	
260–280	290–310	0,10 0,10	0,15 0,15	0,15 0,20	0,20 0,25	0,25 0,30	0,25 0,40	0,30 0,40	0,40 0,50	d x 0,02
260–280	290–310	0,10 0,10	0,15 0,15	0,15 0,20	0,20 0,25	0,25 0,30	0,25 0,40	0,30 0,40	0,40 0,50	
240–260	260–290	0,10 0,10	0,15 0,15	0,15 0,20	0,20 0,25	0,25 0,30	0,25 0,40	0,30 0,40	0,40 0,50	
240–260	260–290	0,10 0,10	0,15 0,15	0,15 0,20	0,20 0,25	0,25 0,30	0,25 0,40	0,30 0,40	0,40 0,50	
220–240	240–260	0,10 0,10	0,15 0,15	0,15 0,20	0,20 0,25	0,25 0,30	0,25 0,40	0,30 0,40	0,40 0,50	
260–280	290–310	0,10 0,10	0,15 0,15	0,15 0,20	0,20 0,25	0,25 0,30	0,25 0,40	0,30 0,40	0,40 0,50	
260–280	290–310	0,10 0,10	0,15 0,15	0,15 0,20	0,20 0,25	0,25 0,30	0,25 0,40	0,30 0,40	0,40 0,50	
280–320	310–350	0,10 0,10	0,15 0,15	0,15 0,20	0,20 0,25	0,25 0,30	0,25 0,40	0,30 0,40	0,40 0,50	
220–240	240–260	0,10 0,10	0,15 0,15	0,15 0,20	0,20 0,25	0,25 0,30	0,25 0,40	0,30 0,40	0,40 0,50	d x 0,02
220–240	240–260	0,10 0,10	0,15 0,15	0,15 0,20	0,20 0,25	0,25 0,30	0,25 0,40	0,30 0,40	0,40 0,50	
220–240	240–260	0,10 0,10	0,15 0,15	0,15 0,20	0,20 0,25	0,25 0,30	0,25 0,40	0,30 0,40	0,40 0,50	d x 0,02
200–220	220–240	0,10 0,10	0,15 0,15	0,15 0,20	0,20 0,25	0,25 0,30	0,25 0,40	0,30 0,40	0,40 0,50	
280–300	310–330	0,10 0,10	0,15 0,15	0,15 0,20	0,20 0,25	0,25 0,30	0,25 0,40	0,30 0,40	0,40 0,50	
200–220	220–240	0,10 0,10	0,15 0,15	0,15 0,20	0,20 0,25	0,25 0,30	0,25 0,40	0,30 0,40	0,40 0,50	
										d x 0,02
280–300	310–330	0,10 0,10	0,15 0,15	0,15 0,20	0,20 0,25	0,25 0,30	0,25 0,40	0,30 0,40	0,40 0,50	
260–280	290–310	0,10 0,10	0,15 0,15	0,15 0,20	0,20 0,25	0,25 0,30	0,25 0,40	0,30 0,40	0,40 0,50	
120–140	130–160	0,10 0,10	0,15 0,15	0,15 0,20	0,20 0,25	0,25 0,30	0,25 0,40	0,30 0,40	0,40 0,50	d x 0,02
80–100	90–110	0,10 0,10	0,15 0,15	0,15 0,20	0,20 0,25	0,25 0,30	0,25 0,40	0,30 0,40	0,40 0,50	
140–160	150–180	0,10 0,08	0,10 0,10	0,10 0,15	0,10 0,18	0,15 0,20	0,20 0,25	0,25 0,25	0,30 0,30	d x 0,02
280–300	310–330	0,10 0,10	0,15 0,15	0,15 0,20	0,20 0,25	0,25 0,30	0,25 0,40	0,30 0,40	0,40 0,50	
240–260	270–290	0,10 0,10	0,15 0,15	0,15 0,20	0,20 0,25	0,25 0,30	0,25 0,40	0,30 0,40	0,40 0,50	
160–200	180–220	0,10 0,08	0,10 0,10	0,10 0,15	0,10 0,18	0,15 0,20	0,20 0,25	0,25 0,25	0,30 0,30	

The cutting data indicated are starting values and must be adjusted to the prevailing conditions.

Schnittwertempfehlungen für Wechsellatte WPR-DN Schlichten





Cutting data recommendations for indexable insert WPR-DN Finishing

	Werkstoff	Material	Werkstoff-Nr. Material No.	DIN Bezeichnung Alt DIN Description Old	R _m /UTS (N/mm ²)	DIN Bezeichnung Neu DIN Description New
N	Aluminium-Legierungen, kurzspanend	Aluminium alloys, short chipping	3.2581	G-AISI12	-400	G-IGK-AISI12
	Aluminium-Legierungen, langspanend	Aluminium alloys, long chipping	3.3535 3.4365	AlMg3 AlZnMgCu1,5	-550	AlMg3 AlZnMgCu1,5
	Kupfer-Legierungen, kurzspanend	Copper alloys, short chipping	2.0402	MS58	-500	CuZn40Pb2
	Kupfer-Legierungen, langspanend	Copper alloys, long chipping	2.0320 2.0975	MS63 CuAl10Ni	300-500	CuZn37 CuAl10Fe5Ni5-C
	Thermoplaste	Thermoplastics		PVC	40-70	PVC
	Duroplaste	Duroplastics		Bakelit, Melamin	20-40	Bakelit, Melamin
	Graphit	Graphite				
	Zirkonoxidkeramik	Zircon oxide ceramics				
S	Titan-Legierungen, mittelfest	Titanium alloys, medium strength	3.7115 3.7164	TiAl5Sn2,5 TiAl6V4	-950	TiAl5Sn2-5 Ti6AlV4
	Titan-Legierungen, hochfest	Titanium alloys, high strength	3.7174	TiAl6Sn2	900-1400	TiAl6V6Sn2
	Nickelbasis-Legierungen, mittelfest	Nickel based alloys, medium strength	2.4670	NiCr12Al6MoNb	-950	NiCr12Al6MoNb
	Nickelbasis-Legierungen, hochwarmfest	Heat resistant nickel based alloys, high strength	2.4668	NiCr19Fe19NbMo	900-1400	Inconel 718 NiCr19Fe19Nb5Mo3
	Kobalt-Chrom-Legierung	Cobalt chromium alloys				

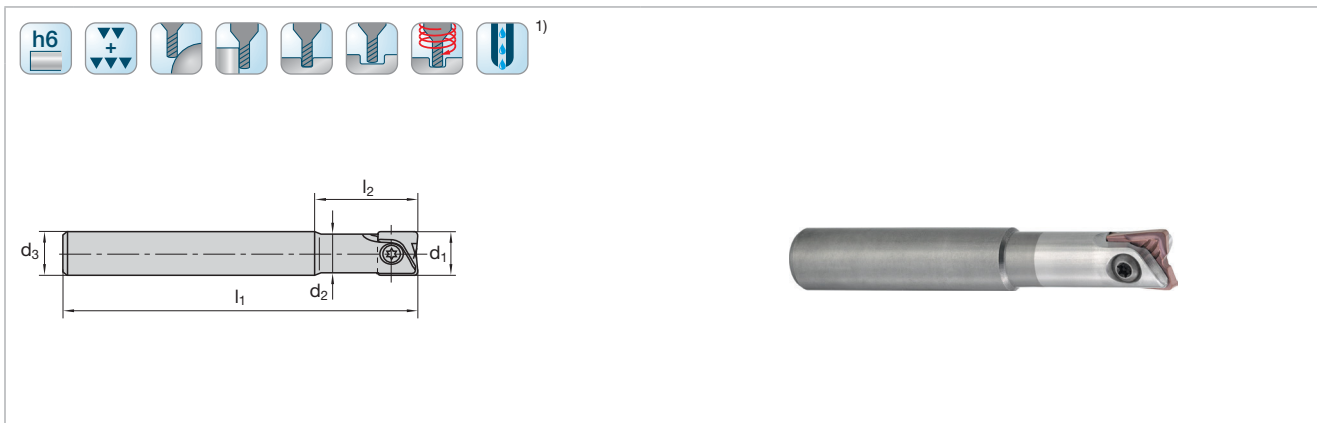
Die angegebenen Schnittwerte sind Startwerte und müssen auf die vorhandenen Bedingungen abgestimmt werden.
The cutting data indicated are starting values and must be adjusted to the prevailing conditions.

Schnittgeschwindigkeit Cutting speed v_c (m/min)		Vorschub pro Zahn Feed per tooth f_z (mm/z.)								a_e Schlichten Finishing
		$\varnothing 6$	$\varnothing 8$	$\varnothing 10$	$\varnothing 12$	$\varnothing 16$	$\varnothing 20$	$\varnothing 25$	$\varnothing 32$	
WPR-DN LWNS10M	WPR-DN LCN10M	a_p max f_z max	a_p max f_z max	a_p max f_z max	a_p max f_z max	a_p max f_z max	a_p max f_z max	a_p max f_z max	a_p max f_z max	
400-600		0,10 0,12	0,15 0,15	0,20 0,18	0,20 0,20	0,30 0,30	0,30 0,30	0,35 0,35	0,40 0,40	d x 0,02
300-400		0,10 0,12	0,15 0,15	0,20 0,18	0,20 0,20	0,30 0,30	0,30 0,30	0,35 0,35	0,40 0,40	
300-400		0,10 0,12	0,15 0,15	0,20 0,18	0,20 0,20	0,30 0,30	0,30 0,30	0,35 0,35	0,40 0,40	
300-400		0,10 0,12	0,15 0,15	0,20 0,18	0,20 0,20	0,30 0,30	0,30 0,30	0,35 0,35	0,40 0,40	
500-600	500-600	0,10 0,12	0,15 0,15	0,20 0,18	0,20 0,20	0,30 0,30	0,30 0,30	0,35 0,35	0,40 0,40	
200-300		0,10 0,12	0,15 0,15	0,20 0,18	0,20 0,20	0,30 0,30	0,30 0,30	0,35 0,35	0,40 0,40	
	600-800	0,10 0,12	0,15 0,15	0,20 0,18	0,20 0,20	0,30 0,30	0,30 0,30	0,35 0,35	0,40 0,40	
400-500		0,10 0,10	0,15 0,10	0,20 0,15	0,20 0,20	0,25 0,25	0,25 0,25	0,30 0,30	0,40 0,35	d x 0,02
350-400		0,10 0,10	0,15 0,10	0,20 0,15	0,20 0,20	0,25 0,25	0,25 0,25	0,30 0,30	0,40 0,35	
40-60		0,10 0,10	0,15 0,10	0,20 0,15	0,20 0,20	0,25 0,25	0,25 0,25	0,30 0,30	0,40 0,35	
40-60		0,10 0,10	0,15 0,10	0,20 0,15	0,20 0,20	0,25 0,25	0,25 0,25	0,30 0,30	0,40 0,35	



Katalog-Nr. Cat.-No.									GWV			
d ₁	l ₂	l ₁	d ₃	d ₂	z	Ident No.	IKZ ¹⁾ Ident No.	LMT-Code				
8	27	82	8	7	2	6131510	–	EBG V08.008AN080-C	WPB 08	WPV 08	GWS 08	T8
8	27	102	8	7	2	6130576	–	EBG V08.008AN100-C				
8	42	152	8	7	2	6130577	–	EBG V08.008AN150-C				
10	37	82	10	8,8	2	9074948	6131512	EBG V10.010AN080-C-I	WPB 10	WPV 10	GWS 10	T15
10	37	122	10	8,8	2	6130578	6131511	EBG V10.010AN120-C-I				
10	52	152	10	8,8	2	6130579	6131513	EBG V10.010AN150-C-I				
12	37	82	12	10,5	2	9074949	6131514	EBG V12.012AN080-C-I	WPB 12	WPV 12	GWS 12	T20
12	37	122	12	10,5	2	6128023	6130402	EBG V12.012AN120-C-I				
12	52	162	12	10,5	2	6128030	6130403	EBG V12.012AN160-C-I				
16	42	102	16	14	2	–	6131515	EBG V16.016AN100-C-I	WPB 16	WPV 16	GWS 16	
16	42	142	16	14	2	–	6130404	EBG V16.016AN140-C-I				
16	57	177	16	14	2	–	6130405	EBG V16.016AN175-C-I				
20	52	102	20	18	2	–	6131516	EBG V20.020AN100-C-I	WPB 20	WPV 20	GWS 20	
20	52	142	20	18	2	–	6130406	EBG V20.020AN140-C-I				
20	77	192	20	18	2	–	6130407	EBG V20.020AN190-C-I				
25	62	162	25	22,4	2	6128035	6130408	EBG V25.025AN160-C-I	WPB 25	WPV 25	GWS 25	T30
25	92	212	25	22,4	2	–	6130409	EBG V25.025AN210-C-I				
32	67	192	32	28,6	2	6128040	–	EBG V32.032AN190-C		WPV 32	GWS 32	

¹⁾ IKZ = Innere Kühlmittelzufuhr
 IKZ = Internal coolant supply

²⁾ Anzugsmoment siehe Tabelle Seite 345
 Torque see overview page 345





Drehmomentschlüssel auf Anfrage
 Torque spanner on request

Ident No. Schrauben und Torx-Schraubendreher siehe Seite 369
 Ident No. Screws and wrenches see page 369

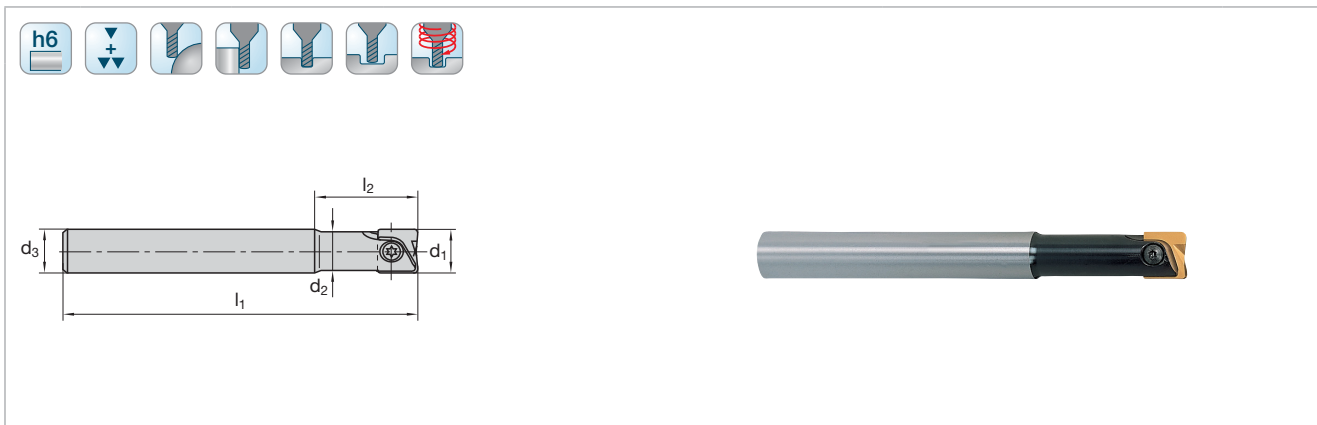
Fräser auch verfügbar in Zoll-Abmessungen
 Cutters also available in inch dimensions

Schnittwertempfehlungen ab Seite 374
 Cutting data recommendations starting page 374



Katalog-Nr. Cat.-No.							GWV				
d ₁	l ₂	l ₁	d ₃	d ₂	z	Ident No.	LMT-Code			 ¹⁾	
12	34	92	12	10,5	2	6130574	EBG V12.012AN090	WPB 12	WPV 12	GWS 12	T20
12	34	132	12	10,5	2	6121399	EBG V12.012AN130				
12	48	152	12	10,5	2	6121383	EBG V12.012AN150				
16	38	102	16	14	2	6130575	EBG V16.016AN100	WPB 16	WPV 16	GWS 16	
16	38	142	16	14	2	6121389	EBG V16.016AN140				
16	55	162	16	14	2	6121391	EBG V16.016AN160				
20	47	162	20	18	2	6121377	EBG V20.020AN160	WPB 20	WPV 20	GWS 20	
20	63	177	20	18	2	6121379	EBG V20.020AN175				
25	47	162	25	22,4	2	6121371	EBG V25.025AN160	WPB 25	WPV 25	GWS 25	T30
25	72	192	25	22,4	2	6121373	EBG V25.025AN190				
32	58	177	32	28,6	2	6121363	EBG V32.032AN175				
32	82	212	32	28,6	2	6121364	EBG V32.032AN210		WPV 32	GWS 32	

¹⁾ Anzugsmoment siehe Tabelle Seite 345
 Torque see overview page 345

Schnittwertempfehlungen ab Seite 374
 Cutting data recommendations starting page 374





IKZ auf Anfrage
 Internal cooling on request

Drehmomentschlüssel auf Anfrage
 Torque spanner on request

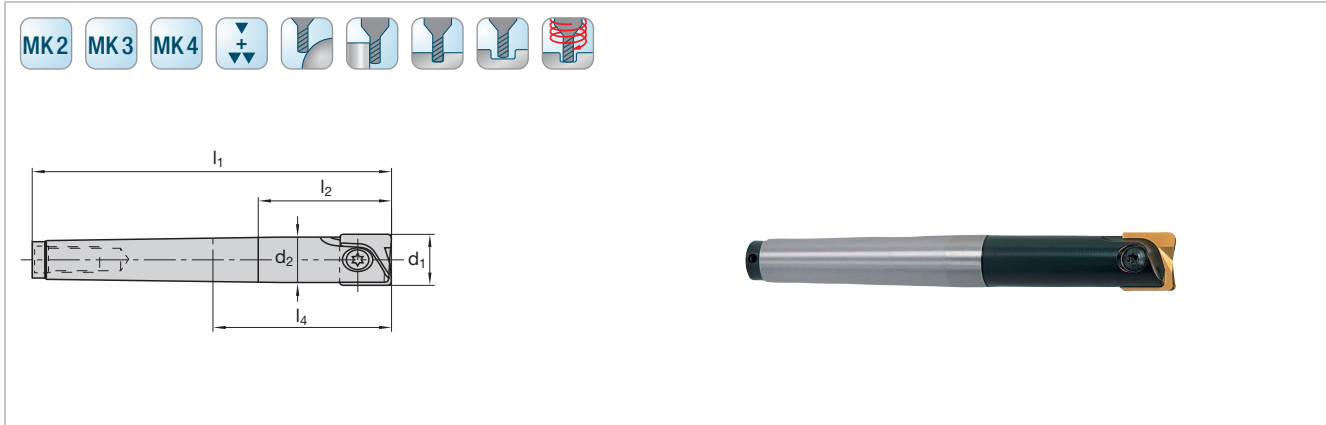
Ident No. Schrauben und Torx-Schraubendreher siehe Seite 369
 Ident No. Screws and wrenches see page 369

Fräser auch verfügbar in Zoll-Abmessungen
 Cutters also available in inch dimensions



Katalog-Nr. Cat.-No.								GWV					
d ₁	l ₂	l ₁	MK	d ₂	l ₄	z	Ident No.	LMT-Code			 ¹⁾		
12	38	117	2	10,5	53	2	6121321	EBG V12.012M2115	WPB 12	WPV 12	GWS 12	T20	
12	55	132	2	10,5	68	2	6121322	EBG V12.012M2130					
16	38	117	2	15	53	2	6121325	EBG V16.016M2115	WPB 16	WPV 16	GWS 16		
16	55	132	2	14	68	2	6121326	EBG V16.016M2130					
20	47	127	2	17,8	63	2	6121313	EBG V20.020M2125	WPB 20	WPV 20	GWS 20		
20	63	142	2	17,8	78	2	6121314	EBG V20.020M2140					
25	47	147	3	22,4	66	2	6121317	EBG V25.025M3145	WPB 25	WPV 25	GWS 25	T30	
25	72	172	3	22,4	91	2	6121318	EBG V25.025M3170					
32	47	167	4	28,6	64,5	2	6121312	EBG V32.032M4165		WPV 32	GWS 32		
32	72	192	4	28,6	89,5	2	6121302	EBG V32.032M4190					

¹⁾ Anzugsmoment siehe Tabelle Seite 345
 Torque see overview page 345





Schnittwertempfehlungen ab Seite 374
 Cutting data recommendations starting page 374

IKZ auf Anfrage
 Internal cooling on request

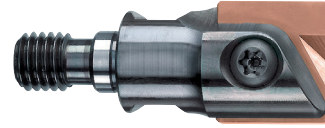
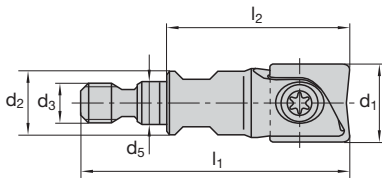
Drehmomentschlüssel auf Anfrage
 Torque spanner on request

Ident No. Schrauben und Torx-Schraubendreher siehe Seite 369
 Ident No. Screws and wrenches see page 369



Katalog-Nr. Cat.-No.										GWV				
d ₁	l ₂	l ₁	sw	d ₃	d ₅	d ₂	z	IKZ ¹⁾	Ident No.	LMT-Code			 ²⁾	
8	25	39,5	8	M6	6,5	10	2	–	6131472	EBG V08.008TC025	WPV 08	WPB 08	GWS 08	T8
10	25	39,5	8	M6	6,5	10	2	–	6131474	EBG V10.010TC025	WPV 10	WPB 10	GWS 10	T15
12	25	39,5	9	M6	6,5	10	2	–	6131476	EBG V12.012TC025	WPV 12	WPB 12	GWS 12	T20
12	28	45,5	10	M8	8,5	13	2	■	6131478	EBG V12.012TR028-I	WPV 12	WPB 12	GWS 12	
16	28	45,5	10	M8	8,5	13	2	■	6131480	EBG V16.016TR028-I	WPV 16	WPB 16	GWS 16	
20	32	51,5	15	M10	10,5	18	2	■	6131482	EBG V20.020TS032-I	WPV 20	WPB 20	GWS 20	
25	42	64	17	M12	12,5	21	2	■	6131484	EBG V25.025TF042-I	WPV 25	WPB 25	GWS 25	T30
32	47	71	26	M16	17	30	2	■	6131486	EBG V32.032TH047-I	WPV 32		GWS 32	

¹⁾ mit IKZ = Innere Kühlmittelzufuhr
with IKZ = Internal coolant supply

²⁾ Anzugsmoment siehe Tabelle Seite 345
Torque see overview page 345



Drehmomentschlüssel auf Anfrage
Torque spanner on request

Ident No. Schrauben und Torx-Schraubendreher siehe Seite 369
Ident No. Screws and wrenches see page 369

Fräser auch verfügbar in Zoll-Abmessungen
Cutters also available in inch dimensions

Schnittwertempfehlungen ab Seite 374
Cutting data recommendations starting page 374

Schrauben und Torx-Schraubendreher Screws and Wrenches

			
LMT-Code	Ident No.	LMT-Code	Ident No.
GWS 06	6260409	T6	6119544
GWS 08	6119572	T8	6119528
GWS 10	6119571	T15	6119529
GWS 12	6119559	T20	6119530
GWS 16	6119560		
GWS 20	6119561		
GWS 25	6119562		
GWS 32	6119563	T30	6119533

								Schneidstoffsorten Cutting materials Ident No.										Für Fräser For cutter Cat.-No.				
N = Anzahl der Schneidkanten N = Number of cutting edges	LMT-Code	l	d	s	d ₁	r	LWP40M	LWNS30M	LWNS10M	LWNS33M	LCP40M	LCPK30M	LCPK10M	LCPK25M	LCPK15M	LCKP10M	LCHK10M		LCH33M	LCN10M	LDN10M	
 N = 2	WPB 06 AF 05	8	6	1,6	2,5	0,5									7214345		7035106		7132591		EBG R 06	
	WPB 08 AF 05	9,3	8	2	3	0,5			7107679						7214346		7062287		7132592		EBG V 08	
	WPB 08 AF 10	9,5	8	2	3	1									7214347		7035107		7132593			
	WPB 10 AF 05	11,3	10	2,5	4	0,5			7107680						7214348		9193919		7132594		EBG V 10	
	WPB 10 AF 10	11,5	10	2,5	4	1			7016821						7214350		9153134		7132595			
	WPB 12 AF 05	13,8	12	2,5	5	0,5			7107681						7214351		7016356		7132596		EBG V 12	
	WPB 12 AF 10	14	12	2,5	5	1			7016822						7214352		9153135		7132597			
	WPB 12 AF 20	14	12	2,5	5	2									7214354		9153137					
	WPB 16 AF 10	16	16	3	5	1			7016823						7214355		9148026		7132599		EBG V 16	
	WPB 16 AF 30	16	16	3	5	3									7214357		9148028					
	WPB 20 AF 10	18	20	3	5	1			7016824						7214359		9153138		7132601		EBG V 20	
	WPB 20 AF 20	18	20	3	5	2									7214360		7043485					
	WPB 20 AF 40	18	20	3	5	4									7214361		9153169					

■ = Hauptanwendung First choice
 □ = Nebenanwendung Alternative

Sortenbeschreibung/-bezeichnung und ISO-Code ab Seite 424/477
 Description/Designation of grades and ISO-Code starting page 424/477

Alle WPR-, WPV- und WPB-Wendepplatten sind in der Sorte LCN10M (diamantbeschichtet) oder PKD/CBN-bestückt auf Anfrage lieferbar.
 All WPR, WPV and WPB inserts are available in grade LCN10M (diamond coated) or PCD/CBN tipped.

															■							P	
															□								M
															■								K
																				■			N
															□								S
															□								H

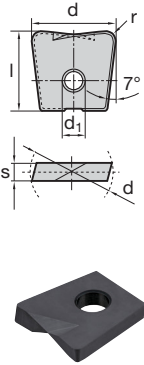
							Schneidstoffsorten Cutting materials Ident No.										Für Fräser For cutter Cat-No.																																																																																																																																										
N = Anzahl der Schneidkanten N = Number of cutting edges	LMT-Code	l	d	s	d ₁	r	LWP40M	LWNS30M	LWNS10M	LWNS33M	LCP40M	LCPK30M	LCPK10M	LCPK25M	LCPK15M	LCPK10M		LCHK10M	LCH33M	LCN10M	LDN10M																																																																																																																																						
 N = 2	WPB 08 N 06	9,5	8	2	3	0,6			6282921						7214312	7108320						EBG V 08																																																																																																																																					
	WPB 08 N 10	9,5	8	2	3	1			6282916						7214313	7108321																																																																																																																																											
	WPB 10 N 08	11,5	10	2,5	4	0,8			6282922						7214314	7108323						EBG V 10																																																																																																																																					
	WPB 10 N 10	11,5	10	2,5	4	1			6282917						7214315	7108324																																																																																																																																											
	WPB 12 N 10	14	12	2,5	5	1			6129226						7214316	7108325						EBG V 12																																																																																																																																					
	WPB 12 N 20	14	12	2,5	5	2			6128105						7214317	7108326																																																																																																																																											
	WPB 16 N 10	16	16	3	5	1			6129228						7214318	7108404						EBG V 16																																																																																																																																					
	WPB 16 N 13	16	16	3	5	1,3			6282923						7214319	7108406																																																																																																																																											
	WPB 16 N 30	16	16	3	5	3			6128109						7214320	7108407																																																																																																																																											
							<table border="0"> <tr> <td>■</td><td>■</td><td>■</td><td>■</td><td>■</td><td>■</td><td>■</td><td>■</td><td>■</td><td>■</td><td>■</td><td>■</td><td>■</td><td>■</td><td>■</td><td>■</td><td>■</td><td>■</td><td>■</td><td>■</td><td>■</td><td>■</td><td>P</td> </tr> <tr> <td></td><td></td><td></td><td></td><td></td><td></td><td></td><td></td><td></td><td></td><td></td><td></td><td></td><td></td><td></td><td></td><td></td><td></td><td></td><td></td><td></td><td></td><td>M</td> </tr> <tr> <td></td><td></td><td></td><td></td><td></td><td></td><td></td><td></td><td></td><td></td><td></td><td></td><td></td><td></td><td></td><td></td><td></td><td></td><td></td><td></td><td></td><td></td><td>K</td> </tr> <tr> <td></td><td></td><td></td><td></td><td></td><td></td><td></td><td></td><td></td><td></td><td></td><td></td><td></td><td></td><td></td><td></td><td></td><td></td><td></td><td></td><td></td><td></td><td>N</td> </tr> <tr> <td></td><td></td><td></td><td></td><td></td><td></td><td></td><td></td><td></td><td></td><td></td><td></td><td></td><td></td><td></td><td></td><td></td><td></td><td></td><td></td><td></td><td></td><td>S</td> </tr> <tr> <td></td><td></td><td></td><td></td><td></td><td></td><td></td><td></td><td></td><td></td><td></td><td></td><td></td><td></td><td></td><td></td><td></td><td></td><td></td><td></td><td></td><td></td><td>H</td> </tr> </table>										■	■	■	■	■	■	■	■	■	■	■	■	■	■	■	■	■	■	■	■	■	■	P																							M																							K																							N																							S																							H	
■	■	■	■	■	■	■	■	■	■	■	■	■	■	■	■	■	■	■	■	■	■	P																																																																																																																																					
																						M																																																																																																																																					
																						K																																																																																																																																					
																						N																																																																																																																																					
																						S																																																																																																																																					
																						H																																																																																																																																					

■ = Hauptanwendung First choice
 □ = Nebenanwendung Alternative

Sortenbeschreibung/-bezeichnung und ISO-Code ab Seite 424/477
 Description/Designation of grades and ISO-Code starting page 424/477

Alle WPR-, WPV- und WPB-Wendepplatten sind in der Sorte LCN10M (diamantbeschichtet) oder PKD/CBN-bestückt auf Anfrage lieferbar.
 All WPR, WPV and WPB inserts are available in grade LCN10M (diamond coated) or PCD/CBN tipped.

							Schneidstoffsorten Cutting materials											Für Fräser For cutter					
							Ident No.																
N = Anzahl der Schneidkanten N = Number of cutting edges	LMT-Code	l	d	s	d ₁	r	LWP40M	LWNS30M	LWNS10M	LWNS33M	LCP40M	LCPK30M	LCPK10M	LCPK25M	LCPK15M	LCKP10M	LCHK10M	LCH33M	LCN10M	LDN10M	Cat-No.		
 N = 2	WPB 20 N 10	18	20	3	5	1			6129230						7214321	7108408						EBG V 20	
	WPB 20 N 16	18	20	3	5	1,6			6282924						7214322	7108412							
	WPB 20 N 40	18	20	3	5	4			6128113						7214323	7108413							
	WPB 25 N 10	23,5	25	4	6	1			6129232						7214324	7108424						EBG V 25	
	WPB 25 N 20	23,5	25	4	6	2			6282926						7214325	7108429							
	WPB 25 N 50	23,5	25	4	6	5			6128117						7214326	7108434							
														■	■							P	
															□	□							M
															■	■							K
															■	■							N
															□	□							S
															□	□							H

■ = Hauptanwendung First choice
 □ = Nebenanwendung Alternative

Sortenbeschreibung/-bezeichnung und ISO-Code ab Seite 424/477
 Description/Designation of grades and ISO-Code starting page 424/477

Alle WPR-, WPV- und WPB-Wendepplatten sind in der Sorte LCN10M (diamantbeschichtet) oder PKD/CBN-bestückt auf Anfrage lieferbar.
 All WPR, WPV and WPB inserts are available in grade LCN10M (diamond coated) or PCD/CBN tipped.

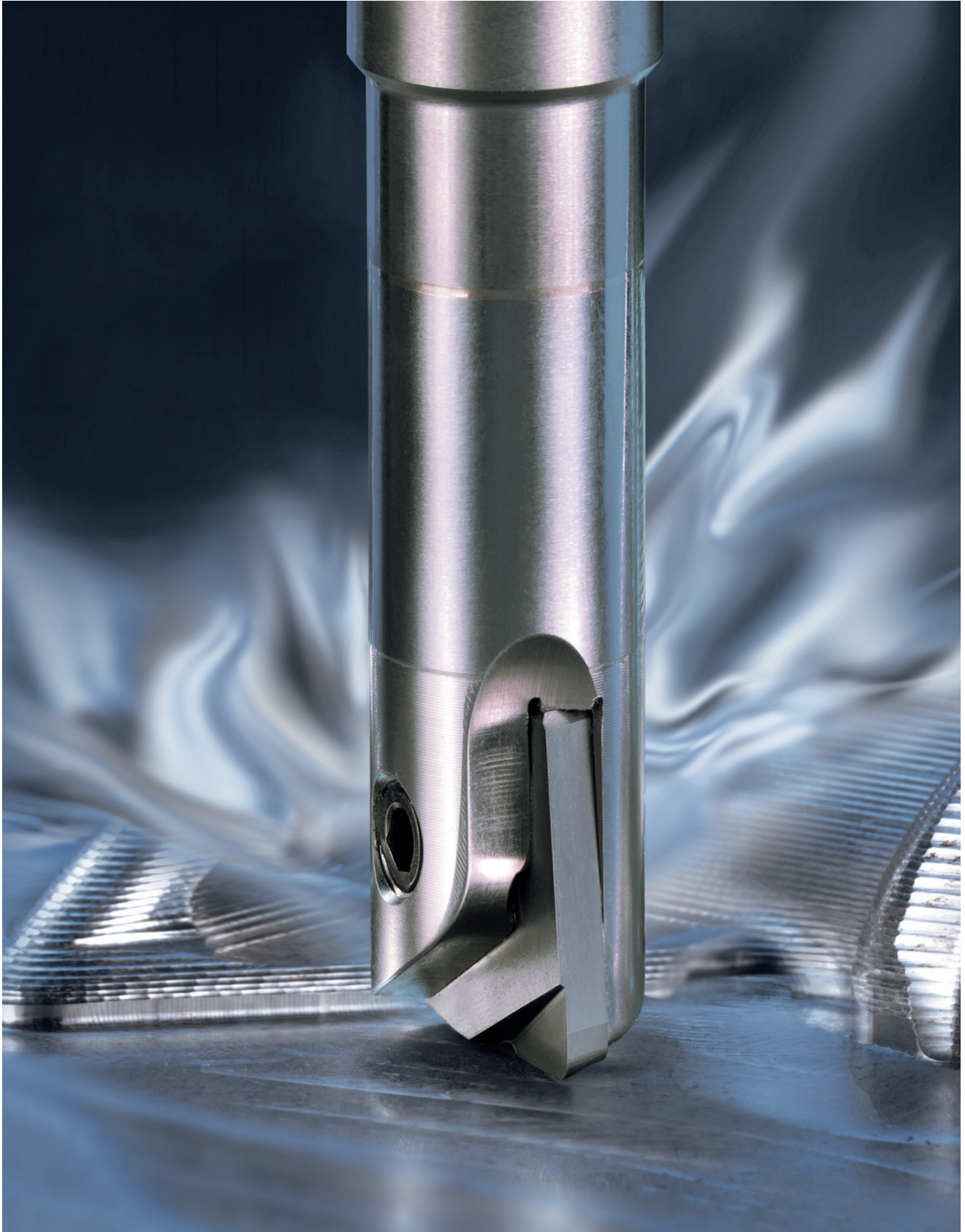

Fräsen mit Wertschneidplatten
Milling with indexable inserts

Schnittwertempfehlungen für Wechsellplatte WPB-AF Schlichten

Cutting data recommendations for indexable insert WPB-AF Schlichten

	Werkstoff	Material	Werkstoff-Nr. Material No.	DIN Bezeichnung Alt DIN Description Old	R _m /UTS (N/mm ²)	DIN Bezeichnung Neu DIN Description New
P	Unlegierter Baustahl + Automatenstahl	Plain carbon steel + free cutting steel	1.0570	St52-3	-700	S355J2G3
			1.1730	C45	-800	C45U
			1.0715	9SMn28	-700	11SMn30
	Vergütungsstahl, mittelfest	Heat-treatment steel, medium strength	1.1191	Ck45	500-950	C45E
			1.7219	26CrMo4	500-950	26CrMo4-2
	Stahlguss	Cast steel	1.7225	42CrMo4	500-950	42CrMo4
			1.8159	51CrV4	-950	51CrV4
	Einsatzstahl	Case hardening steel	1.0416	GS40	-950	GS40
			1.7131	16MnCr5	-950	16MnCr5
	Rost- und säurebe- ständiger Stahl, ferritisch, martensitisch	Stainless steel, ferritic, martensitic	1.4006	X10Cr13	500-950	X12Cr13
			1.4104	X12CrMoS17	500-950	X14CrMoS17
	Vergütungsstahl, hochfest	Heat-treatment steel, high strength	1.4122	X35CrMo17	500-950	X39CrMo17-1
			1.7225	42CrMo4	950-1400	42CrMo4
	Nitrierstahl, vergütet	Nitriding steel, heat treated	1.6580	30CrNiMo8	950-1400	30CrNiMo8
			1.8504	34CrAl6	950-1400	34CrAl6
Werkzeugstahl	Tool steel	1.2344	X40CrMoV5.1	-900	X40CrMoV5-1	
		1.2343	X38CrMoV5 1	950-1400	X37CrMoV5-1	
		1.2379	X155CrVMo12 1	-950	X153CrMoV12-1	
		1.2358	60CrMoV18-5	850-1000	60CrMoV18-5	
		1.2080	X210Cr12	950-1400	X210Cr12	
		1.2714	55NiCrMoV7	1100-1350	55NiCrMoV7	
		1.2311	40CrMnMo7	-1100	40CrMnMo7	
		1.2312	40CrMnNiMoS8.6	-1150	40CrMnNiMoS8-6	
M	Rost- und säurebe- ständiger Stahl, austenitisch	Stainless steel, austenitic	1.2316	X38CrMo16	-1100	X38CrMo16
			1.2738	45CrMnNiMo8.6.4	950-1150	45CrMnNiMo8-6-4
K	Grauguss	Grey cast iron	1.4301	X2CrNiMo17-12-2	500-950	X5CrNiMo18-10
			1.4404	X6CrNiMoTi17-12-2	500-950	X2CrNiMo17-12-2
			1.4571	X10CrNiMoTi18	500-950	X10CrNiMoTi18
K	Legierter Grauguss	Alloyed grey cast iron	1.2709	X3NiCoMoTi18-9-5	800-1000	X3NiCoMoTi18-9-5
			1.4542	X5CrNiCuNb16-4	800-1000	X5CrNiCuNb16-4
			1.4568	X7CrNiAl17-7	800-1000	X7CrNiAl17-7
			0.6025	GG25	100-400 (120-260 HB)	EN-GJI-250
K	Sphäroguss	Nodular cast iron	0.6678	GGL-NiCr35 2	150-250 (160-230 HB)	EN-GJLA-XNiCr35-2
			0.7060	GGG60	400-800 (120-310 HB)	EN-GJS-600-3
			0.7070	GGG70L	400-800 (120-310 HB)	EN-GJS-700-2U
			0.8155	GTS55	350-700 (150-280 HB)	EN-GJMB-550-4
N	Aluminium-Legierungen, kurzspanend	Aluminium alloys, short chipping	3.2581	G-AlSi12	-400	G-IGK-AlSi12
			3.3535	AlMg3	-550	AlMg3
	Aluminium-Legierungen, langspanend	Aluminium alloys, long chipping	3.4365	AlZnMgCu1,5	-500	AlZnMgCu1,5
			2.0402	MS58	-500	CuZn40Pb2
	Kupfer-Legierungen, kurzspanend	Copper alloys, short chipping	2.0320	MS63	300-500	CuZn37
			2.0975	CuAl10Ni	300-500	CuAl10Fe5Ni5-C
	Thermoplaste	Thermoplastics		PVC	40-70	PVC
				Duroplaste	20-40	Bakelit, Melamin
S	Titan-Legierungen, mittelfest	Titanium alloys, medium strength		Bakelit, Melamin		
				Graphit		
S	Titan-Legierungen, hochfest	Titanium alloys, high strength		Zirkonoxidkeramik		
S	Nickelbasis-Legierungen, mittelfest	Nickel based alloys, medium strength	3.7115	TiAl5Sn2,5	-950	TiAl5Sn2-5
			3.7164	TiAl6V4	-950	Ti6AlV4
	Nickelbasis-Legierungen, hochwarmfest	Heat resistant nickel based alloys, high strength	3.7174	TiAl6Sn2	900-1400	TiAl6V6Sn2
			2.4670	NiCr12Al6MoNb	-950	NiCr12Al6MoNb
Kobalt-Chrom-Legierung	Cobalt chromium alloys	2.4668	NiCr19Fe19NbMo	900-1400	Inconel 718	
					NiCr19Fe19Nb5Mo3	
H	Hartguss	Chilled cast iron		Ni-hard, Ampco	300-600 HB	Ni-hard, Ampco
H	Gehärteter Stahl	Hardened steel			45-52 HRC	
					53-59 HRC	
					60-65 HRC	

Die angegebenen Schnittwerte sind Startwerte und müssen auf die vorhandenen Bedingungen abgestimmt werden.

Schnittgeschwindigkeit Cutting speed v_c (m/min)				Vorschub pro Zahn Feed per tooth f_z (mm/z.)						a_e Schichten Ebene Finishing plane	a_e Schichten step (Kontur) Finishing step (Contour)
				$\varnothing 6$	$\varnothing 8$	$\varnothing 10$	$\varnothing 12$	$\varnothing 16$	$\varnothing 20$		
WPB-AF LCHK10M	WPB-AF LCPK15M	WPB-AF LWNS10M	WPB-AF LCN10M	a_p max f_z max	a_p max f_z max	a_p max f_z max	a_p max f_z max	a_p max f_z max	a_p max f_z max	max. 70 %	
280-300				0,05-0,10 0,08-0,12	0,10-0,20 0,10-0,15	0,20-0,30 0,15-0,20	0,20-0,30 0,20-0,25	0,20-0,30 0,20-0,25	0,30-0,40 0,20-0,25		
280-300				0,05-0,10 0,08-0,12	0,10-0,20 0,10-0,15	0,20-0,30 0,15-0,20	0,20-0,30 0,20-0,25	0,20-0,30 0,20-0,25	0,30-0,40 0,20-0,25		
280-300				0,05-0,10 0,08-0,12	0,10-0,20 0,10-0,15	0,20-0,30 0,15-0,20	0,20-0,30 0,20-0,25	0,20-0,30 0,20-0,25	0,30-0,40 0,20-0,25		
280-300				0,05-0,10 0,08-0,12	0,10-0,20 0,10-0,15	0,20-0,30 0,15-0,20	0,20-0,30 0,20-0,25	0,20-0,30 0,20-0,25	0,30-0,40 0,20-0,25		
240-260				0,05-0,10 0,08-0,12	0,10-0,20 0,10-0,15	0,20-0,30 0,15-0,20	0,20-0,30 0,20-0,25	0,20-0,30 0,20-0,25	0,30-0,40 0,20-0,25		
280-300				0,05-0,10 0,08-0,12	0,10-0,20 0,10-0,15	0,20-0,30 0,15-0,20	0,20-0,30 0,20-0,25	0,20-0,30 0,20-0,25	0,30-0,40 0,20-0,25		
220-240				0,05-0,10 0,08-0,12	0,10-0,20 0,10-0,15	0,20-0,30 0,15-0,20	0,20-0,30 0,20-0,25	0,20-0,30 0,20-0,25	0,30-0,40 0,20-0,25		
200-220				0,05-0,10 0,08-0,12	0,10-0,20 0,10-0,15	0,20-0,30 0,15-0,20	0,20-0,30 0,20-0,25	0,20-0,30 0,20-0,25	0,30-0,40 0,20-0,25		
240-260				0,05-0,10 0,08-0,12	0,10-0,20 0,10-0,15	0,20-0,30 0,15-0,20	0,20-0,30 0,20-0,25	0,20-0,30 0,20-0,25	0,30-0,40 0,20-0,25		
280-340				0,05-0,10 0,08-0,12	0,10-0,20 0,10-0,15	0,20-0,30 0,15-0,20	0,20-0,30 0,20-0,25	0,20-0,30 0,20-0,25	0,30-0,40 0,20-0,25		
220-240				0,05-0,10 0,08-0,12	0,10-0,20 0,10-0,15	0,20-0,30 0,15-0,20	0,20-0,30 0,20-0,25	0,20-0,30 0,20-0,25	0,30-0,40 0,20-0,25	d x 0,3 - d x 0,7	0,1-0,3
220-240				0,05-0,10 0,08-0,12	0,10-0,20 0,10-0,15	0,20-0,30 0,15-0,20	0,20-0,30 0,20-0,25	0,20-0,30 0,20-0,25	0,30-0,40 0,20-0,25		
240-260				0,05-0,10 0,08-0,12	0,10-0,20 0,10-0,15	0,20-0,30 0,15-0,20	0,20-0,30 0,20-0,25	0,20-0,30 0,20-0,25	0,30-0,40 0,20-0,25	d x 0,3 - d x 0,7	0,1-0,3
220-240				0,05-0,10 0,08-0,12	0,10-0,20 0,10-0,15	0,20-0,30 0,15-0,20	0,20-0,30 0,20-0,25	0,20-0,30 0,20-0,25	0,30-0,40 0,20-0,25		
240-280				0,05-0,10 0,08-0,12	0,10-0,20 0,10-0,15	0,20-0,30 0,15-0,20	0,20-0,30 0,20-0,25	0,20-0,30 0,20-0,25	0,30-0,40 0,20-0,25		
240-280				0,05-0,10 0,08-0,12	0,10-0,20 0,10-0,15	0,20-0,30 0,15-0,20	0,20-0,30 0,20-0,25	0,20-0,30 0,20-0,25	0,30-0,40 0,20-0,25		
	600-800			0,20 0,08-0,12	0,25 0,10-0,15	0,25 0,15-0,20	0,30 0,15-0,20	0,35 0,20-0,25	0,35 0,20-0,25	d x 0,3 - d x 0,7	0,1-0,3
	300-400			0,20 0,08-0,12	0,25 0,10-0,15	0,25 0,15-0,20	0,30 0,15-0,20	0,35 0,20-0,25	0,35 0,20-0,25		
400-450				0,20 0,08-0,12	0,25 0,10-0,15	0,25 0,15-0,20	0,30 0,15-0,20	0,35 0,20-0,25	0,35 0,20-0,25		
300-350				0,20 0,08-0,12	0,25 0,10-0,15	0,25 0,15-0,20	0,30 0,15-0,20	0,35 0,20-0,25	0,35 0,20-0,25		
	600-800			0,20 0,08-0,12	0,25 0,10-0,15	0,25 0,15-0,20	0,30 0,15-0,20	0,35 0,20-0,25	0,35 0,20-0,25		
	200-250			0,20 0,08-0,12	0,25 0,10-0,15	0,25 0,15-0,20	0,30 0,15-0,20	0,35 0,20-0,25	0,35 0,20-0,25		
		600-800		0,05-0,10 0,08-0,12	0,10-0,20 0,10-0,15	0,20-0,30 0,15-0,20	0,20-0,30 0,20-0,25	0,20-0,30 0,25-0,30	0,30-0,40 0,25-0,35		
	120-140			0,05-0,10 0,08-0,12	0,10-0,20 0,10-0,15	0,20-0,30 0,15-0,20	0,20-0,30 0,20-0,25	0,20-0,30 0,20-0,25	0,30-0,40 0,20-0,25		
	100-120			0,05-0,10 0,08-0,12	0,10-0,20 0,10-0,15	0,20-0,30 0,15-0,20	0,20-0,30 0,20-0,25	0,20-0,30 0,20-0,25	0,30-0,40 0,20-0,25		
80-100				0,05-0,10 0,08-0,12	0,10-0,20 0,10-0,15	0,20-0,30 0,15-0,20	0,20-0,30 0,20-0,25	0,20-0,30 0,20-0,25	0,30-0,40 0,20-0,25		
60-80				0,05-0,10 0,08-0,12	0,10-0,20 0,10-0,15	0,20-0,30 0,15-0,20	0,20-0,30 0,20-0,25	0,20-0,30 0,20-0,25	0,30-0,40 0,20-0,25		
120-140				0,05-0,10 0,08-0,12	0,10-0,20 0,10-0,15	0,20-0,30 0,15-0,20	0,20-0,30 0,20-0,25	0,20-0,30 0,20-0,25	0,30-0,40 0,20-0,25	d x 0,3 - d x 0,7	0,1-0,3
240-260				0,05-0,10 0,08-0,12	0,10-0,20 0,10-0,15	0,20-0,30 0,15-0,20	0,20-0,30 0,20-0,25	0,20-0,30 0,20-0,25	0,30-0,40 0,20-0,25		
160-180				0,05-0,08 0,08-0,12	0,10-0,15 0,10-0,15	0,12-0,18 0,15-0,18	0,15-0,20 0,15-0,18	0,18-0,25 0,15-0,20	0,18-0,25 0,18-0,22		
100-120				0,05-0,08 0,08-0,12	0,10-0,15 0,10-0,15	0,12-0,18 0,15-0,18	0,15-0,20 0,15-0,18	0,18-0,25 0,15-0,20	0,18-0,25 0,18-0,22		
				0,05-0,08 0,08-0,12	0,10-0,15 0,10-0,15	0,12-0,18 0,15-0,18	0,15-0,20 0,15-0,18	0,18-0,25 0,15-0,20	0,18-0,25 0,18-0,22		

The cutting data indicated are starting values and must be adjusted to the prevailing conditions.

Schnittwertempfehlungen für Wechsellatte WPB-N Schruppen

Cutting data recommendations for indexable insert WPB-N Roughing

	Werkstoff	Material	Werkstoff-Nr. Material No.	DIN Bezeichnung Alt DIN Description Old	R _m /UTS (N/mm ²)	DIN Bezeichnung Neu DIN Description New	
P	Unlegierter Baustahl + Automatenstahl	Plain carbon steel + free cutting steel	1.0570	St52-3	-700	S355J2G3	
			1.1730	C45	-800	C45U	
			1.0715	9SMn28	-700	11SMn30	
				1.1191	Ck45	500-950	C45E
				1.7219	26CrMo4		26CrMo4-2
	Vergütungsstahl, mittelfest	Heat-treatment steel, medium strength	1.7225	42CrMo4	500-950	42CrMo4	
			1.8159	51CrV4		51CrV4	
	Stahlguss	Cast steel	1.0416	GS40	-950	GS40	
	Einsatzstahl	Case hardening steel	1.7131	16MnCr5	-950	16MnCr5	
	Rost- und säurebe- ständiger Stahl, ferritisch, martensitisch	Stainless steel, ferritic, martensitic	1.4006	X10Cr13	500-950	X12Cr13	
			1.4104	X12CrMoS17		X14CrMoS17	
			1.4122	X35CrMo17		X39CrMo17-1	
	Vergütungsstahl, hochfest	Heat-treatment steel, high strength	1.7225	42CrMo4	950-1400	42CrMo4	
			1.6580	30CrNiMo8		30CrNiMo8	
	Nitrierstahl, vergütet	Nitriding steel, heat treated	1.8504	34CrAl6	950-1400	34CrAl6	
		1.2344	X40CrMoV5.1	-900	X40CrMoV5-1		
Werkzeugstahl	Tool steel	1.2343	X38CrMoV5 1	950-1400	X37CrMoV5-1		
		1.2379	X155CrVMo12 1	-950	X153CrMoV12-1		
		1.2358	60CrMoV18-5	850-1000	60CrMoV18-5		
		1.2080	X210Cr12	950-1400	X210Cr12		
		1.2714	55NiCrMoV7	1100-1350	55NiCrMoV7		
		1.2311	40CrMnMo7	-1100	40CrMnMo7		
		1.2312	40CrMnNiMoS8.6	-1150	40CrMnNiMoS8-6		
		1.2316	X38CrMo16	-1100	X38CrMo16		
		1.2738	45CrMnNiMo8.6.4	950-1150	45CrMnNiMo8-6-4		
		M	Rost- und säurebe- ständiger Stahl, austenitisch	Stainless steel, austenitic	1.4301	X2CrNiMo17-12-2	500-950
1.4404	X6CrNiMoTi17-12-2					X2CrNiMo17-12-2	
1.4571	X10CrNiMoTi18					X10CrNiMoTi18	
Rost- und säurebe- ständiger Stahl, martensitisch aushärtbar	Stainless steel, martensitic steel	1.2709	X3NiCoMoTi18-9-5	800-1000	X3NiCoMoTi18-9-5		
		1.4542	X5CrNiCuNb16-4		X5CrNiCuNb16-4		
		1.4568	X7CrNiAl17-7		X7CrNiAl17-7		
K	Grauguss	Grey cast iron	0.6025	GG25	100-400 (120-260 HB)	EN-GJL-250	
			0.6678	GGL-NiCr35 2	150-250 (160-230 HB)	EN-GJLA-XNiCr35-2	
	Sphäroguss	Nodular cast iron	0.7060	GGG60	400-800	EN-GJS-600-3	
			0.7070	GGG70L	(120-310 HB)	EN-GJS-700-2U	
Temperguss	Malleable cast iron	0.8155	GTS55	350-700 (150-280 HB)	EN-GJMB-550-4		
N	Aluminium-Legierungen, kurzspanend	Aluminium alloys, short chipping	3.2581	G-AlSi12	-400	G-IGK-AlSi12	
	Aluminium-Legierungen, langspanend	Aluminium alloys, long chipping	3.3535	AlMg3	-550	AlMg3	
	Kupfer-Legierungen, kurzspanend	Copper alloys, short chipping	3.4365	AlZnMgCu1,5		AlZnMgCu1,5	
			2.0402	MS58	-500	CuZn40Pb2	
	Kupfer-Legierungen, langspanend	Copper alloys, long chipping	2.0320	MS63	300-500	CuZn37	
			2.0975	CuAl10Ni		CuAl10Fe5Ni5-C	
	Thermoplaste	Thermoplastics		PVC	40-70	PVC	
	Duroplaste	Duroplastics		Bakelit, Melamin	20-40	Bakelit, Melamin	
S	Titan-Legierungen, mittelfest	Titanium alloys, medium strength	3.7115	TiAl5Sn2,5	-950	TiAl5Sn2-5	
			3.7164	TiAl6V4		Ti6AlV4	
	Titan-Legierungen, hochfest	Titanium alloys, high strength	3.7174	TiAl6Sn2	900-1400	TiAl6V6Sn2	
	Nickelbasis-Legierungen, mittelfest	Nickel based alloys, medium strength	2.4670	NiCr12Al6MoNb	-950	NiCr12Al6MoNb	
	Nickelbasis-Legierungen, hochwarmfest	Heat resistant nickel based alloys, high strength	2.4668	NiCr19Fe19NbMo	900-1400	Inconel 718 NiCr19Fe19Nb5Mo3	
	Kobalt-Chrom-Legierung	Cobalt chromium alloys					
H	Hartguss	Chilled cast iron		Ni-hard, Ampco	300-600 HB	Ni-hard, Ampco	
	Gehärteter Stahl	Hardened steel			45-52 HRC		
					53-59 HRC		
				60-65 HRC			

Die angegebenen Schnittwerte sind Startwerte und müssen auf die vorhandenen Bedingungen abgestimmt werden.

Schnittgeschwindigkeit Cutting speed v_c (m/min)		Vorschub pro Zahn Feed per tooth f_z (mm/z.)								WPV a_p max l Maß l Dimension	WPB a_p max r + w	a_e Schruppen step Roughing step	a_e Schruppen Ebene Roughing plane
		$\varnothing 6$	$\varnothing 8$	$\varnothing 10$	$\varnothing 12$	$\varnothing 16$	$\varnothing 20$	$\varnothing 25$	$\varnothing 32$				
WPB-N LCKP10M LCPK15M	WPB-N LCP40M	f_z max	f_z max	f_z max	f_z max	f_z max	f_z max	f_z max	f_z max				
180-200	160-180	0,20	0,25	0,30	0,35	0,40	0,45	0,45	0,50		r + w	0,1-0,3	d x 0,3-0,7
180-200	160-180	0,20	0,25	0,30	0,35	0,40	0,45	0,45	0,50				
180-200	160-180	0,20	0,25	0,30	0,35	0,40	0,45	0,45	0,50				
180-200	160-180	0,20	0,25	0,30	0,35	0,40	0,45	0,45	0,50				
180-200	160-180	0,20	0,25	0,30	0,35	0,40	0,45	0,45	0,50				
180-200	160-180	0,20	0,25	0,30	0,35	0,40	0,45	0,45	0,50				
160-180	140-160	0,20	0,25	0,30	0,35	0,40	0,45	0,45	0,50				
140-160	120-140	0,20	0,25	0,30	0,35	0,40	0,45	0,45	0,50				
140-160	120-140	0,20	0,25	0,30	0,35	0,40	0,45	0,45	0,50				
180-200	160-180	0,20	0,25	0,30	0,35	0,40	0,45	0,45	0,50		r + w	0,1-0,3	d x 0,3-0,7
140-160	120-140	0,20	0,25	0,30	0,35	0,40	0,45	0,45	0,50				
120-140	100-120	0,20	0,25	0,30	0,35	0,40	0,45	0,45	0,50		r + w	0,1-0,3	d x 0,3-0,7
160-180		0,20	0,25	0,30	0,35	0,40	0,45	0,45	0,50				
140-160		0,20	0,25	0,30	0,35	0,40	0,45	0,45	0,50				
180-200	160-180	0,20	0,25	0,30	0,35	0,40	0,45	0,45	0,50				
160-180	140-160	0,20	0,25	0,30	0,35	0,40	0,45	0,45	0,50		r + w		
											r + w		
180-200	160-180	0,20	0,25	0,30	0,35	0,40	0,45	0,45	0,50		r + w	0,1-0,3	d x 0,3-0,7
140-160	120-140	0,20	0,25	0,30	0,35	0,40	0,45	0,45	0,50				

Fräsen mit Wendeschneidplatten
Milling with indexable inserts

The cutting data indicated are starting values and must be adjusted to the prevailing conditions.

Schnittwertempfehlungen für Wechsellplatte WPB-N Schlichten

Cutting data recommendations for indexable insert WPB-N Finishing

	Werkstoff	Material	Werkstoff-Nr. Material No.	DIN Bezeichnung Alt DIN Description Old	R _m /UTS (N/mm ²)	DIN Bezeichnung Neu DIN Description New
P	Unlegierter Baustahl + Automatenstahl	Plain carbon steel + free cutting steel	1.0570	St52-3	-700	S355J2G3
			1.1730	C45	-800	C45U
			1.0715	9SMn28	-700	11SMn30
			1.1191 1.7219	Ck45 26CrMo4	500-950	C45E 26CrMo4-2
	Vergütungsstahl, mittelfest	Heat-treatment steel, medium strength	1.7225 1.8159	42CrMo4 51CrV4	500-950	42CrMo4 51CrV4
	Stahlguss	Cast steel	1.0416	GS40	-950	GS40
	Einsatzstahl	Case hardening steel	1.7131	16MnCr5	-950	16MnCr5
	Rost- und säurebe- ständiger Stahl, ferritisch, martensitisch	Stainless steel, ferritic, martensitic	1.4006	X10Cr13	500-950	X12Cr13
			1.4104 1.4122	X12CrMoS17 X35CrMo17		X14CrMoS17 X39CrMo17-1
	Vergütungsstahl, hochfest	Heat-treatment steel, high strength	1.7225 1.6580	42CrMo4 30CrNiMo8	950-1400	42CrMo4 30CrNiMo8
	Nitrierstahl, vergütet	Nitriding steel, heat treated	1.8504	34CrAl6	950-1400	34CrAl6
			1.2344	X40CrMoV5.1	-900	X40CrMoV5-1
	Werkzeugstahl	Tool steel	1.2343	X38CrMoV5 1	950-1400	X37CrMoV5-1
			1.2379	X155CrVMo12 1	-950	X153CrMoV12-1
1.2358			60CrMoV18-5	850-1000	60CrMoV18-5	
1.2080			X210Cr12	950-1400	X210Cr12	
1.2714			55NiCrMoV7	1100-1350	55NiCrMoV7	
1.2311			40CrMnMo7	-1100	40CrMnMo7	
1.2312			40CrMnNiMoS8.6	-1150	40CrMnNiMoS8-6	
1.2316 1.2738			X38CrMo16 45CrMnNiMo8.6.4	-1100 950-1150	X38CrMo16 45CrMnNiMo8-6-4	
M	Rost- und säurebe- ständiger Stahl, austenitisch	Stainless steel, austenitic	1.4301	X2CrNiMo17-12-2	500-950	X5CrNiMo18-10
			1.4404	X6CrNiMoTi17-12-2		X2CrNiMo17-12-2
			1.4571	X10CrNiMoTi18		X10CrNiMoTi18
Rost- und säurebe- ständiger Stahl, martensitisch aushärtbar	Stainless steel, martensitic steel	1.2709	X3NiCoMoTi18-9-5	800-1000	X3NiCoMoTi18-9-5	
		1.4542 1.4568	X5CrNiCuNb16-4 X7CrNiAl17-7		X5CrNiCuNb16-4 X7CrNiAl17-7	
K	Grauguss	Grey cast iron	0.6025	GG25	100-400 (120-260 HB)	EN-GJL-250
			0.6678	GGL-NiCr35 2	150-250 (160-230 HB)	EN-GJLA-XNICr35-2
	Sphäroguss	Nodular cast iron	0.7060	GGG60	400-800	EN-GJS-600-3
			0.7070	GGG70L	(120-310 HB)	EN-GJS-700-2U
Temperguss	Malleable cast iron	0.8155	GTS55	350-700 (150-280 HB)	EN-GJMB-550-4	
N	Aluminium-Legierungen, kurzspanend	Aluminium alloys, short chipping	3.2581	G-AISi12	-400	G-IGK-AISi12
	Aluminium-Legierungen, langspanend	Aluminium alloys, long chipping	3.3535	AlMg3	-550	AlMg3
			3.4365	AlZnMgCu1,5	-500	CuZn40Pb2
	Kupfer-Legierungen, kurzspanend	Copper alloys, short chipping	2.0402	MS58	-500	CuZn40Pb2
			2.0320 2.0975	MS63 CuAl10Ni	300-500	CuZn37 CuAl10Fe5Ni5-C
	Thermoplaste	Thermoplastics		PVC	40-70	PVC
	Duroplaste	Duroplastics		Bakelit, Melamin	20-40	Bakelit, Melamin
	Graphit	Graphite				
Zirkonoxidkeramik	Zircon oxide ceramics					
S	Titan-Legierungen, mittelfest	Titanium alloys, medium strength	3.7115 3.7164	TiAl5Sn2,5 TiAl6V4	-950	TiAl5Sn2-5 TiAl6V4
	Titan-Legierungen, hochfest	Titanium alloys, high strength	3.7174	TiAl6Sn2	900-1400	TiAl6V6Sn2
	Nickelbasis-Legierungen, mittelfest	Nickel based alloys, medium strength	2.4670	NiCr12Al6MoNb	-950	NiCr12Al6MoNb
	Nickelbasis-Legierungen, hochwarmfest	Heat resistant nickel based alloys, high strength	2.4668	NiCr19Fe19NbMo	900-1400	Inconel 718 NiCr19Fe19Nb5Mo3
	Kobalt-Chrom-Legierung	Cobalt chromium alloys				
H	Hartguss	Chilled cast iron		Ni-hard, Ampco	300-600 HB	Ni-hard, Ampco
	Gehärteter Stahl	Hardened steel			45-52 HRC	
					53-59 HRC 60-65 HRC	

Die angegebenen Schnittwerte sind Startwerte und müssen auf die vorhandenen Bedingungen abgestimmt werden.

Schnittgeschwindigkeit Cutting speed v_c (m/min)	Vorschub pro Zahn Feed per tooth f_z (mm/z.)								a_e Schlichten step (Kontur) Finishing step (Contour)	a_e Schlichten Ebene Finishing plane	
	Ø 6	Ø 8	Ø 10	Ø 12	Ø 16	Ø 20	Ø 25	Ø 32			
WPB-N LCKP10M LCPK15M	a_p max f_z max	a_p max f_z max	a_p max f_z max	a_p max f_z max	a_p max f_z max	a_p max f_z max	a_p max f_z max	a_p max f_z max	a_p max f_z max		
220-240	0,05-0,10 0,08-0,12	0,10-0,20 0,10-0,15	0,20-0,30 0,15-0,20	0,20-0,30 0,20-0,25	0,20-0,30 0,20-0,25	0,30-0,40 0,20-0,25	0,40-0,50 0,20-0,30	0,40-0,60 0,20-0,30	d x 0,02	d x 0,3 - d x 0,7	
220-240	0,05-0,10 0,08-0,12	0,10-0,20 0,10-0,15	0,20-0,30 0,15-0,20	0,20-0,30 0,20-0,25	0,20-0,30 0,20-0,25	0,30-0,40 0,20-0,25	0,40-0,50 0,20-0,30	0,40-0,60 0,20-0,30			
220-240	0,05-0,10 0,08-0,12	0,10-0,20 0,10-0,15	0,20-0,30 0,15-0,20	0,20-0,30 0,20-0,25	0,20-0,30 0,20-0,25	0,30-0,40 0,20-0,25	0,40-0,50 0,20-0,30	0,40-0,60 0,20-0,30			
220-240	0,05-0,10 0,08-0,12	0,10-0,20 0,10-0,15	0,20-0,30 0,15-0,20	0,20-0,30 0,20-0,25	0,20-0,30 0,20-0,25	0,30-0,40 0,20-0,25	0,40-0,50 0,20-0,30	0,40-0,60 0,20-0,30			
240-260	0,05-0,10 0,08-0,12	0,10-0,20 0,10-0,15	0,20-0,30 0,15-0,20	0,20-0,30 0,20-0,25	0,20-0,30 0,20-0,25	0,30-0,40 0,20-0,25	0,40-0,50 0,20-0,30	0,40-0,60 0,20-0,30			
220-240	0,05-0,10 0,08-0,12	0,10-0,20 0,10-0,15	0,20-0,30 0,15-0,20	0,20-0,30 0,20-0,25	0,20-0,30 0,20-0,25	0,30-0,40 0,20-0,25	0,40-0,50 0,20-0,30	0,40-0,60 0,20-0,30			
200-240	0,05-0,10 0,08-0,12	0,10-0,20 0,10-0,15	0,20-0,30 0,15-0,20	0,20-0,30 0,20-0,25	0,20-0,30 0,20-0,25	0,30-0,40 0,20-0,25	0,40-0,50 0,20-0,30	0,40-0,60 0,20-0,30			
200-220	0,05-0,10 0,08-0,12	0,10-0,20 0,10-0,15	0,20-0,30 0,15-0,20	0,20-0,30 0,20-0,25	0,20-0,30 0,20-0,25	0,30-0,40 0,20-0,25	0,40-0,50 0,20-0,30	0,40-0,60 0,20-0,30			
220-240	0,05-0,10 0,08-0,12	0,10-0,20 0,10-0,15	0,20-0,30 0,15-0,20	0,20-0,30 0,20-0,25	0,20-0,30 0,20-0,25	0,30-0,40 0,20-0,25	0,40-0,50 0,20-0,30	0,40-0,60 0,20-0,30			
240-280	0,05-0,10 0,08-0,12	0,10-0,20 0,10-0,15	0,20-0,30 0,15-0,20	0,20-0,30 0,20-0,25	0,20-0,30 0,20-0,25	0,30-0,40 0,20-0,25	0,40-0,50 0,20-0,30	0,40-0,60 0,20-0,30			
200-220	0,05-0,10 0,08-0,12	0,10-0,20 0,10-0,15	0,20-0,30 0,15-0,20	0,20-0,30 0,20-0,25	0,20-0,30 0,20-0,25	0,30-0,40 0,20-0,25	0,40-0,50 0,20-0,30	0,40-0,60 0,20-0,30	d x 0,02	d x 0,3 - d x 0,7	
200-220	0,05-0,10 0,08-0,12	0,10-0,20 0,10-0,15	0,20-0,30 0,15-0,20	0,20-0,30 0,20-0,25	0,20-0,30 0,20-0,25	0,30-0,40 0,20-0,25	0,40-0,50 0,20-0,30	0,40-0,60 0,20-0,30			
240-260	0,05-0,10 0,08-0,12	0,10-0,20 0,10-0,15	0,20-0,30 0,15-0,20	0,20-0,30 0,20-0,25	0,20-0,30 0,20-0,25	0,30-0,40 0,20-0,25	0,40-0,50 0,20-0,30	0,40-0,60 0,20-0,30			
220-240	0,05-0,10 0,08-0,12	0,10-0,20 0,10-0,15	0,20-0,30 0,15-0,20	0,20-0,30 0,20-0,25	0,20-0,30 0,20-0,25	0,30-0,40 0,20-0,25	0,40-0,50 0,20-0,30	0,40-0,60 0,20-0,30			
120-140	0,05-0,08 0,06-0,08	0,10-0,15 0,08-0,12	0,12-0,18 0,10-0,12	0,15-0,20 0,12-0,18	0,18-0,25 0,15-0,20	0,18-0,25 0,18-0,22	0,20-0,30 0,20-0,25	0,30-0,40 0,30-0,35	d x 0,15-0,18	d x 0,1 - d x 0,3	
220-240	0,05-0,10 0,08-0,12	0,10-0,20 0,10-0,15	0,20-0,30 0,15-0,20	0,20-0,30 0,20-0,25	0,20-0,30 0,20-0,25	0,30-0,40 0,20-0,25	0,40-0,50 0,20-0,30	0,40-0,60 0,20-0,30	d x 0,02	d x 0,3 - d x 0,7	
180-200	0,05-0,10 0,08-0,12	0,10-0,20 0,10-0,15	0,20-0,30 0,15-0,20	0,20-0,30 0,20-0,25	0,20-0,30 0,20-0,25	0,30-0,40 0,20-0,25	0,40-0,50 0,20-0,30	0,40-0,60 0,20-0,30	d x 0,15-0,18	d x 0,1 - d x 0,3	
120-140	0,05-0,08 0,06-0,08	0,10-0,15 0,08-0,12	0,12-0,18 0,10-0,12	0,15-0,20 0,12-0,18	0,18-0,25 0,15-0,20	0,18-0,25 0,18-0,22	0,20-0,30 0,20-0,25	0,30-0,40 0,30-0,35	d x 0,15-0,18	d x 0,1 - d x 0,3	

Fräsen mit Wendeschneidplatten
Milling with indexable inserts

The cutting data indicated are starting values and must be adjusted to the prevailing conditions.

							Schneidstoffsorten Cutting materials											Für Fräser For cutter					
							Ident No.																
N = Anzahl der Schneidkanten N = Number of cutting edges	ISO-Code	l	d	s	d ₁	r	LWP40M	LWNS30M	LWNS10M	LWNS33M	LCP40M	LCPK30M	LCPK10M	LCPK25M	LCPK15M	LCKP10M	LCHK10M	LCH33M	LCN10M	LDN10M	Cat-No.		
 N = 2	WPB 06 CF 05	8	6	1,6	2,5	0,5			6129234				9075747							6282824	EBG R 06		
	WPB 08 CF 10	9,5	8	2	3	1			6129236				7014307							6282825	EBG V 08		
	WPB 10 CF 10	11,5	10	2,5	4	1			6129238				7006341							6282826	EBG V 10		
	WPB 12 CF 10	14	12	2,5	5	1			6282909				7014312							6282827	EBG V 12		
	WPB 12 CF 20	14	12	2,5	5	2			6128107				7016146									EBG V 12	
	WPB 16 CF 10	16	16	3	5	1			6282910				7014313							6282828		EBG V 16	
	WPB 16 CF 30	16	16	3	5	3			6128111				7016149										EBG V 16
	WPB 20 CF 10	18	20	3	5	1			6282911				7014308										EBG V 20
	WPB 20 CF 40	18	20	3	5	4			6128115				7016151										EBG V 20
	WPB 25 CF 10	23,5	25	4	6	1			6282912				7014314										EBG V 25
	WPB 25 CF 50	23,5	25	4	6	5			6128119				7016152										EBG V 25

■ = Hauptanwendung First choice
 □ = Nebenanwendung Alternative

Sortenbeschreibung/-bezeichnung und ISO-Code ab Seite 424/477
 Description/Designation of grades and ISO-Code starting page 424/477

Alle WPR-, WPV- und WPB-Wendepplatten sind in der Sorte LCN10M (diamantbeschichtet) oder PKD/CBN-bestückt auf Anfrage lieferbar.

All WPR, WPV and WPB inserts are available in grade LCN10M (diamond coated) or PKD/CBN tipped.

																						P
																						M
																						K
																						N
																						S
																						H

							Schneidstoffsorten Cutting materials Ident No.										Für Fräser For cutter Cat-No.					
N = Anzahl der Schneidkanten N = Number of cutting edges	ISO-Code	l	d	s	d ₁	r	LWP40M	LWNS30M	LWNS10M	LWNS33M	LCP40M	LCPK30M	LCPK10M	LCPK25M	LCPK15M	LCKP10M		LCHK10M	LCH33M	LCN10M	LDN10M	
 N = 2	WPV 08 N	9,5	8	2	3	0,6	6122608		6122594		7016008					7108592					EBG V 08	
	WPV 10 N	11,5	10	2,5	4	0,8	6122682		6122668		7016009					7108596					EBG V 10	
	WPV 12 N	14	12	2,5	5	1	6122672		6122664		7016131					7108601					EBG V 12	
	WPV 16 N	16	16	3	5	1,3	6122650		6122640		7016133					7108604					EBG V 16	
	WPV 20 N	18	20	3	5	1,6	6122644		6122634		7016135					7108605					EBG V 20	
	WPV 25 N	23,5	25	4	6	2	6122638		6122628		7016138					7108607					EBG V 25	
	WPV 32 N	28	32	5	8	2,5	6122614		6122620		7016141					7108608					EBG V 32	
							■				■				■						P	
																□						M
																	■					K
																						N
																						S
																						H

■ = Hauptanwendung First choice
 □ = Nebenanwendung Alternative

Sortenbeschreibung/-bezeichnung und ISO-Code ab Seite 424/477
 Description/Designation of grades and ISO-Code starting page 424/477

Alle WPR-, WPV- und WPB-Wendeplatten sind in der Sorte LCN10M (diamantbeschichtet) oder PKD/CBN-bestückt auf Anfrage lieferbar.
 All WPR, WPV and WPB inserts are available in grade LCN10M (diamond coated) or PCD/CBN tipped.

Fräsen mit Wendeschneidplatten
Milling with indexable inserts

							Schneidstoffsorten Cutting materials Ident No.											Für Fräser For cutter Cat-No.					
N = Anzahl der Schneidkanten N = Number of cutting edges	ISO-Code	l	d	s	d ₁	r	LWP40M	LWNS30M	LWNS10M	LWNS33M	LCP40M	LCPK30M	LCPK10M	LCPK25M	LCPK15M	LCKP10M	LCHK10M		LCH33M	LCN10M	LDN10M		
 N = 2	WPV 08 CF	9,5	8	2	3	0,6	6122538		6122543		7017875	7014249										EBG V 08	
	WPV 10 CF	11,5	10	2,5	4	0,8	6122598		6122586		6132354	7014303										EBG V 10	
	WPV 12 CF	14	12	2,5	5	1	6122590		6122579		7016130	7014302										EBG V 12	
	WPV 16 CF	16	16	3	5	1,3	6122583		6122572		7016132	7014301										EBG V 16	
	WPV 20 CF	18	20	3	5	1,6	6122576		6122565		7016134	7014300										EBG V 20	
	WPV 25 CF	23,5	25	4	6	2	6122569		6122558		7016136	7016137										EBG V 25	
	WPV 32 CF	28	32	5	8	2,5	6122546		6122550			7016140										EBG V 32	
							■				■	■										P	
												□											M
													■										K
								■															N
																							S
																							H

■ = Hauptanwendung First choice
 □ = Nebenanwendung Alternative

Sortenbeschreibung/-bezeichnung und ISO-Code ab Seite 424/477
 Description/Designation of grades and ISO-Code starting page 424/477

Alle WPR-, WPV- und WPB-Wendeplatten sind in der Sorte LCN10M (diamantbeschichtet) oder PKD/CBN-bestückt auf Anfrage lieferbar.
 All WPR, WPV and WPB inserts are available in grade LCN10M (diamond coated) or PCD/CBN tipped.

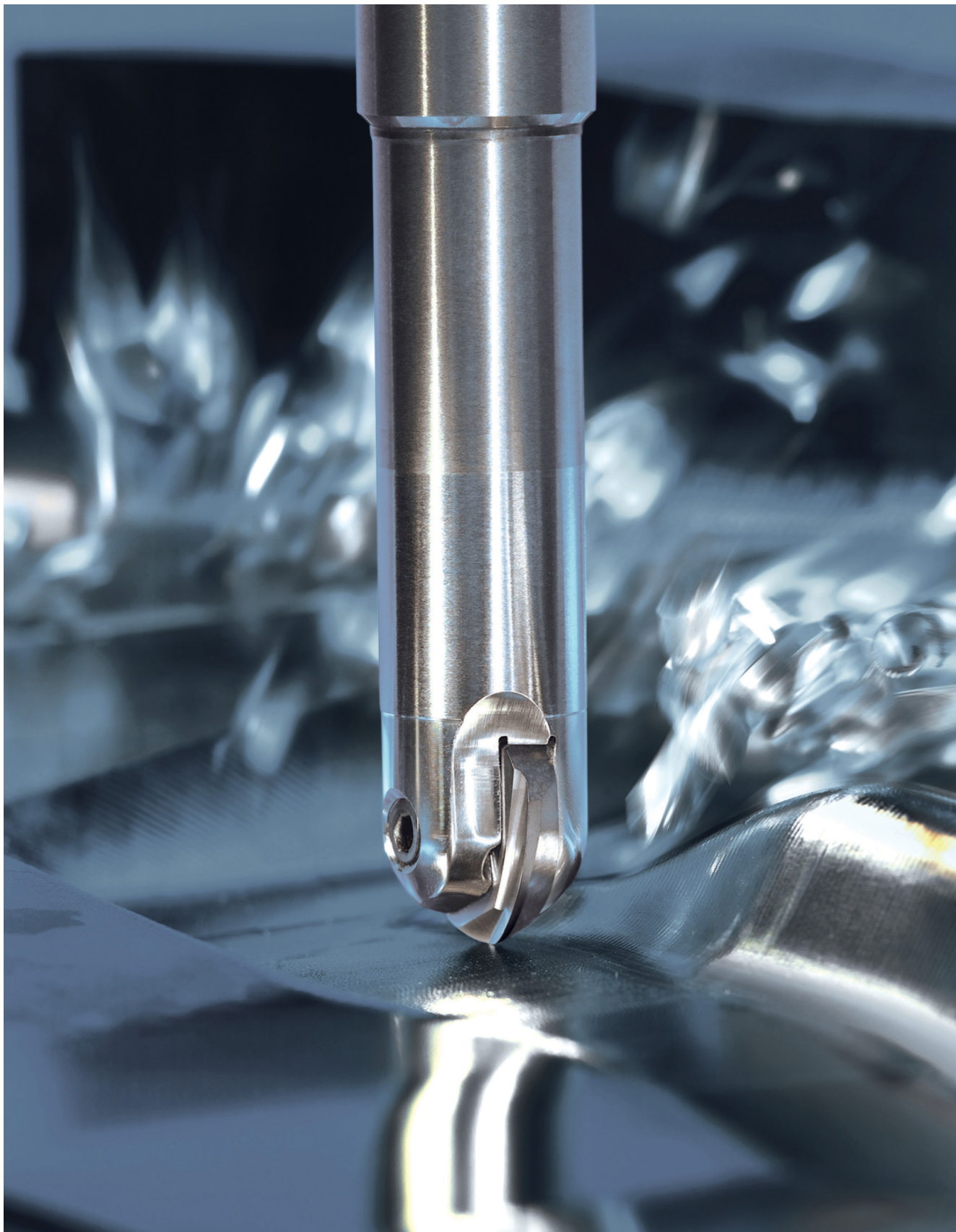

Fräsen mit Wertschneidplatten
Milling with indexable inserts

Schnittwertempfehlungen für Wechsellatte WPB-CF/WPV-CF Schruppen
Cutting data recommendations for indexable insert WPB-CF/WPV-CF Roughing

	Werkstoff	Material	Werkstoff-Nr. Material No.	DIN Bezeichnung Alt DIN Description Old	R_m/UTS (N/mm²)	DIN Bezeichnung Neu DIN Description New
P	Unlegierter Baustahl + Automatenstahl	Plain carbon steel + free cutting steel	1.0570	St52-3	-700	S355J2G3
			1.1730	C45	-800	C45U
			1.0715	9SMn28	-700	11SMn30
			1.1191	Ck45	500-950	C45E
			1.7219	26CrMo4	500-950	26CrMo4-2
	Vergütungsstahl, mittelfest	Heat-treatment steel, medium strength	1.7225	42CrMo4	500-950	42CrMo4
	Stahlguss	Cast steel	1.8159	51CrV4	-950	51CrV4
	Einsatzstahl	Case hardening steel	1.0416	GS40	-950	GS40
	Rost- und säurebe- ständiger Stahl, ferritisch, martensitisch	Stainless steel, ferritic, martensitic	1.7131	16MnCr5	-950	16MnCr5
			1.4006	X10Cr13	500-950	X12Cr13
	Vergütungsstahl, hochfest	Heat-treatment steel, high strength	1.4104	X12CrMoS17	500-950	X14CrMoS17
			1.4122	X35CrMo17	950-1400	X39CrMo17-1
	Nitrierstahl, vergütet	Nitriding steel, heat treated	1.7225	42CrMo4	950-1400	42CrMo4
	Werkzeugstahl	Tool steel	1.6580	30CrNiMo8	950-1400	30CrNiMo8
			1.8504	34CrAl6	950-1400	34CrAl6
M	Rost- und säurebe- ständiger Stahl, austenitisch	Stainless steel, austenitic	1.2344	X40CrMoV5.1	-900	X40CrMoV5-1
			1.2343	X38CrMoV5 1	950-1400	X37CrMoV5-1
			1.2379	X155CrVMo12 1	-950	X153CrMoV12-1
	Rost- und säurebe- ständiger Stahl, martensitisch aushärtbar	Stainless steel, martensitic steel	1.2358	60CrMoV18-5	850-1000	60CrMoV18-5
			1.2080	X210Cr12	950-1400	X210Cr12
	Grauguss	Grey cast iron	1.2714	55NiCrMoV7	1100-1350	55NiCrMoV7
			1.2311	40CrMnMo7	-1100	40CrMnMo7
			1.2312	40CrMnNiMoS8.6	-1150	40CrMnNiMoS8-6
			1.2316	X38CrMo16	-1100	X38CrMo16
			1.2738	45CrMnNiMo8.6.4	950-1150	45CrMnNiMo8-6-4
Legierter Grauguss	Alloyed grey cast iron	1.4301	X2CrNiMo17-12-2	500-950	X5CrNiMo18-10	
		1.4404	X6CrNiMoTi17-12-2	800-1000	X2CrNiMo17-12-2	
		1.4571	X10CrNiMoTi18	800-1000	X10CrNiMoTi18	
Sphäroguss	Nodular cast iron	1.2709	X3NiCoMoTi18-9-5	800-1000	X3NiCoMoTi18-9-5	
		1.4542	X5CrNiCuNb16-4	800-1000	X5CrNiCuNb16-4	
		1.4568	X7CrNiAl17-7	800-1000	X7CrNiAl17-7	
		0.6025	GG25	100-400 (120-260 HB)	EN-GJL-250	
Temperguss	Malleable cast iron	0.6678	GGL-NiCr35 2	150-250 (160-230 HB)	EN-GJLA-XNICr35-2	
		0.7060	GGG60	400-800 (120-310 HB)	EN-GJS-600-3	
		0.7070	GGG70L	400-800 (120-310 HB)	EN-GJS-700-2U	
		0.8155	GTS55	350-700 (150-280 HB)	EN-GJMB-550-4	
N	Aluminium-Legierungen, kurzspanend	Aluminium alloys, short chipping	3.2581	G-AISi12	-400	G-IGK-AISi12
	Aluminium-Legierungen, langspanend	Aluminium alloys, long chipping	3.3535	AlMg3	-550	AlMg3
	Kupfer-Legierungen, kurzspanend	Copper alloys, short chipping	3.4365	AlZnMgCu1,5	-500	AlZnMgCu1,5
	Kupfer-Legierungen, langspanend	Copper alloys, long chipping	2.0402	MS58	-500	CuZn40Pb2
	Thermoplaste	Thermoplastics	2.0320	MS63	300-500	CuZn37
	Duroplaste	Duroplastics	2.0975	CuAl10Ni	40-70	CuAl10Fe5Ni5-C
	Graphit	Graphite		PVC	20-40	PVC
	Zirkonoxidkeramik	Zircon oxide ceramics		Bakelit, Melamin		Bakelit, Melamin
S	Titan-Legierungen, mittelfest	Titanium alloys, medium strength	3.7115	TiAl5Sn2,5	-950	TiAl5Sn2-5
	Titan-Legierungen, hochfest	Titanium alloys, high strength	3.7164	TiAl6V4	900-1400	Ti6AlV4
	Nickelbasis-Legierungen, mittelfest	Nickel based alloys, medium strength	3.7174	TiAl6Sn2	900-1400	TiAl6V6Sn2
	Nickelbasis-Legierungen, hochwarmfest	Heat resistant nickel based alloys, high strength	2.4670	NiCr12Al6MoNb	-950	NiCr12Al6MoNb
	Kobalt-Chrom-Legierung	Cobalt chromium alloys	2.4668	NiCr19Fe19NbMo	900-1400	Inconel 718 NiCr19Fe19Nb5Mo3
H	Hartguss	Chilled cast iron		Ni-hard, Ampco	300-600 HB	Ni-hard, Ampco
	Gehärteter Stahl	Hardened steel			45-52 HRC	
					53-59 HRC	
				60-65 HRC		

Die angegebenen Schnittwerte sind Startwerte und müssen auf die vorhandenen Bedingungen abgestimmt werden.

Schnittgeschwindigkeit Cutting speed v_c (m/min)				Vorschub pro Zahn Feed per tooth f_z (mm/z.)								WPV a_p max I Maß I Dimension	WPB a_p max r + w	a_e Schruppen step (Kontur) Roughing step (Contour)	a_e Schruppen Ebene Roughing plane	
				\emptyset 6	\emptyset 8	\emptyset 10	\emptyset 12	\emptyset 16	\emptyset 20	\emptyset 25	\emptyset 32					
WPB-CF WPV-CF LCPK10M	WPB-CF WPV-CF LWNS10M	WPV-CF LWP40M	WPV-CF LCP40M	a_p min f_z max	a_p min f_z max	a_p min f_z max	a_p min f_z max	a_p min f_z max	a_p min f_z max	a_p min f_z max	a_p min f_z max	a_p min f_z max				
180-200			160-180	0,10 0,20	0,10 0,25	0,10 0,30	0,15 0,35	0,15 0,40	0,15 0,45	0,20 0,45	0,20 0,50			r + w	d x 0,08-0,12	d x 0,3-0,7
180-200			160-180	0,10 0,20	0,10 0,25	0,10 0,30	0,15 0,35	0,15 0,40	0,15 0,45	0,20 0,45	0,20 0,50			r + w	d x 0,08-0,12	d x 0,3-0,7
180-200			160-180	0,10 0,20	0,10 0,25	0,10 0,30	0,15 0,35	0,15 0,40	0,15 0,45	0,20 0,45	0,20 0,50			r + w	d x 0,08-0,12	d x 0,3-0,7
180-200			160-180	0,10 0,20	0,10 0,25	0,10 0,30	0,15 0,35	0,15 0,40	0,15 0,45	0,20 0,45	0,20 0,50			r + w	d x 0,08-0,12	d x 0,3-0,7
180-200			160-180	0,10 0,20	0,10 0,25	0,10 0,30	0,15 0,35	0,15 0,40	0,15 0,45	0,20 0,45	0,20 0,50			r + w	d x 0,08-0,12	d x 0,3-0,7
180-200			160-180	0,10 0,20	0,10 0,25	0,10 0,30	0,15 0,35	0,15 0,40	0,15 0,45	0,20 0,45	0,20 0,50			r + w	d x 0,08-0,12	d x 0,3-0,7
160-180			140-160	0,10 0,20	0,10 0,25	0,10 0,30	0,15 0,35	0,15 0,40	0,15 0,45	0,20 0,45	0,20 0,50			r + w	d x 0,08-0,12	d x 0,3-0,7
140-160			120-140	0,10 0,20	0,10 0,25	0,10 0,30	0,15 0,35	0,15 0,40	0,15 0,45	0,20 0,45	0,20 0,50			r + w	d x 0,08-0,12	d x 0,3-0,7
140-160			120-140	0,10 0,20	0,10 0,25	0,10 0,30	0,15 0,35	0,15 0,40	0,15 0,45	0,20 0,45	0,20 0,50			r + w	d x 0,08-0,12	d x 0,3-0,7
180-200			160-180	0,10 0,20	0,10 0,25	0,10 0,30	0,15 0,35	0,15 0,40	0,15 0,45	0,20 0,45	0,20 0,50			r + w	d x 0,08-0,12	d x 0,3-0,7
140-160			120-140	0,10 0,20	0,10 0,25	0,10 0,30	0,15 0,35	0,15 0,40	0,15 0,45	0,20 0,45	0,20 0,50			r + w	d x 0,08-0,12	d x 0,3-0,7
120-140			100-120	0,10 0,20	0,10 0,25	0,10 0,30	0,15 0,35	0,15 0,40	0,15 0,45	0,20 0,45	0,20 0,50			r + w	d x 0,08-0,12	d x 0,3-0,7
160-180				0,10 0,20	0,10 0,25	0,10 0,30	0,15 0,35	0,15 0,40	0,15 0,45	0,20 0,45	0,20 0,50			r + w	d x 0,08-0,12	d x 0,3-0,7
140-160				0,10 0,20	0,10 0,25	0,10 0,30	0,15 0,35	0,15 0,40	0,15 0,45	0,20 0,45	0,20 0,50			r + w	d x 0,08-0,12	d x 0,3-0,7
180-200			160-180	0,10 0,20	0,10 0,25	0,10 0,30	0,15 0,35	0,15 0,40	0,15 0,45	0,20 0,45	0,20 0,50			r + w	d x 0,08-0,12	d x 0,3-0,7
160-180			140-160	0,10 0,20	0,10 0,25	0,10 0,30	0,15 0,35	0,15 0,40	0,15 0,45	0,20 0,45	0,20 0,50			r + w	d x 0,08-0,12	d x 0,3-0,7
400-500	400-500			0,10 0,25	0,10 0,30	0,10 0,35	0,15 0,40	0,15 0,45	0,15 0,50	0,20 0,65	0,20 0,80			r + w		
300-400	300-400			0,10 0,25	0,10 0,30	0,10 0,35	0,15 0,40	0,15 0,45	0,15 0,50	0,20 0,65	0,20 0,80			r + w		
300-400	300-400			0,10 0,25	0,10 0,30	0,10 0,35	0,15 0,40	0,15 0,45	0,15 0,50	0,20 0,60	0,20 0,70			r + w		
250-300	250-300			0,10 0,25	0,10 0,30	0,10 0,35	0,15 0,40	0,15 0,45	0,15 0,50	0,20 0,60	0,20 0,70			r + w		
500-600				0,10 0,25	0,10 0,30	0,10 0,35	0,15 0,40	0,15 0,45	0,15 0,50	0,20 0,60	0,20 0,70			r + w		
300-400				0,10 0,25	0,10 0,30	0,10 0,35	0,15 0,40	0,15 0,45	0,15 0,50	0,20 0,60	0,20 0,70			r + w		
														r + w		
	100-120			0,10 0,15	0,10 0,20	0,10 0,25	0,15 0,30	0,15 0,35	0,15 0,35	0,20 0,40	0,20 0,40			r + w		
	80-100			0,10 0,15	0,10 0,20	0,10 0,25	0,15 0,30	0,15 0,35	0,15 0,35	0,20 0,40	0,20 0,40			r + w		
	80-100			0,10 0,15	0,10 0,20	0,10 0,25	0,15 0,30	0,15 0,35	0,15 0,35	0,20 0,40	0,20 0,40			r + w		
	60-80			0,10 0,15	0,10 0,20	0,10 0,25	0,15 0,30	0,15 0,35	0,15 0,35	0,20 0,40	0,20 0,40			r + w		
180-200			160-180	0,10 0,15	0,10 0,20	0,10 0,25	0,15 0,30	0,15 0,35	0,15 0,35	0,20 0,40	0,20 0,40			r + w	d x 0,08-0,12	d x 0,3-0,7
140-160			120-140	0,10 0,15	0,10 0,20	0,10 0,25	0,15 0,30	0,15 0,35	0,15 0,35	0,20 0,40	0,20 0,40			r + w	d x 0,08-0,12	d x 0,3-0,7

Fräsen mit Wertschneidplatten
Milling with indexable inserts

The cutting data indicated are starting values and must be adjusted to the prevailing conditions.

Schnittwertempfehlungen für Wechsellatte WPB-CF, WPV-CF Schlichten
Cutting data recommendations for indexable insert WPB-CF, WPV-CF Finishing

	Werkstoff	Material	Werkstoff-Nr. Material No.	DIN Bezeichnung Alt DIN Description Old	R_m/UTS (N/mm²)	DIN Bezeichnung Neu DIN Description New
P	Unlegierter Baustahl + Automatenstahl	Plain carbon steel + free cutting steel	1.0570	St52-3	-700	S355J2G3
			1.1730	C45	-800	C45U
			1.0715	9SMn28	-700	11SMn30
	Vergütungsstahl, mittelfest	Heat-treatment steel, medium strength	1.1191	Ck45	500-950	C45E
			1.7219	26CrMo4	500-950	26CrMo4-2
	Stahlguss	Cast steel	1.7225	42CrMo4	500-950	42CrMo4
			1.8159	51CrV4	-950	51CrV4
	Einsatzstahl	Case hardening steel	1.0416	GS40	-950	GS40
			1.7131	16MnCr5	-950	16MnCr5
	Rost- und säurebe- ständiger Stahl, ferritisch, martensitisch	Stainless steel, ferritic, martensitic	1.4006	X10Cr13	500-950	X12Cr13
			1.4104	X12CrMoS17	500-950	X14CrMoS17
			1.4122	X35CrMo17	500-950	X39CrMo17-1
	Vergütungsstahl, hochfest	Heat-treatment steel, high strength	1.7225	42CrMo4	950-1400	42CrMo4
			1.6580	30CrNiMo8	950-1400	30CrNiMo8
	Nitrierstahl, vergütet	Nitriding steel, heat treated	1.8504	34CrAl6	950-1400	34CrAl6
			1.2344	X40CrMoV5.1	-900	X40CrMoV5-1
Werkzeugstahl	Tool steel	1.2343	X38CrMoV5 1	950-1400	X37CrMoV5-1	
		1.2379	X155CrVMo12 1	-950	X153CrMoV12-1	
		1.2358	60CrMoV18-5	850-1000	60CrMoV18-5	
		1.2080	X210Cr12	950-1400	X210Cr12	
		1.2714	55NiCrMoV7	1100-1350	55NiCrMoV7	
		1.2311	40CrMnMo7	-1100	40CrMnMo7	
		1.2312	40CrMnNiMoS8.6	-1150	40CrMnNiMoS8-6	
		1.2316	X38CrMo16	-1100	X38CrMo16	
		1.2738	45CrMnNiMo8.6.4	950-1150	45CrMnNiMo8-6-4	
M	Rost- und säurebe- ständiger Stahl, austenitisch	Stainless steel, austenitic	1.4301	X2CrNiMo17-12-2	500-950	X5CrNiMo18-10
			1.4404	X6CrNiMoTi17-12-2	500-950	X2CrNiMo17-12-2
			1.4571	X10CrNiMoTi18	500-950	X10CrNiMoTi18
Rost- und säurebe- ständiger Stahl, martensitisch aushärtbar	Stainless steel, martensitic steel	1.2709	X3NiCoMoTi18-9-5	800-1000	X3NiCoMoTi18-9-5	
		1.4542	X5CrNiCuNb16-4	800-1000	X5CrNiCuNb16-4	
		1.4568	X7CrNiAl17-7	800-1000	X7CrNiAl17-7	
K	Grauguss	Grey cast iron	0.6025	GG25	100-400 (120-260 HB)	EN-GJL-250
			0.6678	GGL-NiCr35 2	150-250 (160-230 HB)	EN-GJLA-XNiCr35-2
	Sphäroguss	Nodular cast iron	0.7060	GGG60	400-800	EN-GJS-600-3
			0.7070	GGG70L	(120-310 HB)	EN-GJS-700-2U
Temperguss	Malleable cast iron	0.8155	GTS55	350-700 (150-280 HB)	EN-GJMB-550-4	
N	Aluminium-Legierungen, kurzspanend	Aluminium alloys, short chipping	3.2581	G-AlSi12	-400	G-IGK-AlSi12
	Aluminium-Legierungen, langspanend	Aluminium alloys, long chipping	3.3535	AlMg3	-550	AlMg3
	Kupfer-Legierungen, kurzspanend	Copper alloys, short chipping	3.4365	AlZnMgCu1,5	-500	AlZnMgCu1,5
	Kupfer-Legierungen, langspanend	Copper alloys, long chipping	2.0402	MS58	-500	CuZn40Pb2
	Thermoplaste	Thermoplastics	2.0320	MS63	300-500	CuZn37
			2.0975	CuAl10Ni	300-500	CuAl10Fe5Ni5-C
	Duroplaste	Duroplastics		PVC	40-70	PVC
	Graphit	Graphite		Bakelit, Melamin	20-40	Bakelit, Melamin
S	Titan-Legierungen, mittelfest	Titanium alloys, medium strength	3.7115	TiAl5Sn2,5	-950	TiAl5Sn2-5
	Titan-Legierungen, hochfest	Titanium alloys, high strength	3.7164	TiAl6V4	-950	Ti6AlV4
	Nickelbasis-Legierungen, mittelfest	Nickel based alloys, medium strength	3.7174	TiAl6Sn2	900-1400	TiAl6V6Sn2
	Nickelbasis-Legierungen, hochwarmfest	Nickel based alloys, high strength	2.4670	NiCr12Al6MoNb	-950	NiCr12Al6MoNb
	Kobalt-Chrom-Legierung	Cobalt chromium alloys	2.4668	NiCr19Fe19NbMo	900-1400	Inconel 718
						NiCr19Fe19Nb5Mo3
H	Hartguss	Chilled cast iron		Ni-hard, Ampco	300-600 HB	Ni-hard, Ampco
	Gehärteter Stahl	Hardened steel			45-52 HRC	
					53-59 HRC	
				60-65 HRC		

Die angegebenen Schnittwerte sind Startwerte und müssen auf die vorhandenen Bedingungen abgestimmt werden.

Schnittgeschwindigkeit Cutting speed v_c (m/min)					Vorschub pro Zahn Feed per tooth f_z (mm/z.)								a_p Schlichten step (Kontur) Finishing step (Contour)	a_e Schichten Ebene Finishing plane
					$\emptyset 6$	$\emptyset 8$	$\emptyset 10$	$\emptyset 12$	$\emptyset 16$	$\emptyset 20$	$\emptyset 25$	$\emptyset 32$		
WPB-CF WPV-CF LCKP10M	WPB-CF WPV-CF LWNS10M	WPB-CF WPV-CF LCN10M	WPV-CF LWP40M	WPV-CF LCP40M	a_p max f_z max	a_p max f_z max	a_p max f_z max	a_p max f_z max	a_p max f_z max	a_p max f_z max	a_p max f_z max	a_p max f_z max	a_p max f_z max	
240-260					0,05-0,10 0,08-0,12	0,10-0,20 0,10-0,15	0,20-0,30 0,15-0,20	0,20-0,30 0,20-0,25	0,20-0,30 0,25-0,30	0,30-0,40 0,25-0,35	0,40-0,50 0,30-0,40	0,40-0,60 0,30-0,40	d x 0,02	d x 0,3-0,7
240-260					0,05-0,10 0,08-0,12	0,10-0,20 0,10-0,15	0,20-0,30 0,15-0,20	0,20-0,30 0,20-0,25	0,20-0,30 0,25-0,30	0,30-0,40 0,25-0,35	0,40-0,50 0,30-0,40	0,40-0,60 0,30-0,40		
240-260					0,05-0,10 0,08-0,12	0,10-0,20 0,10-0,15	0,20-0,30 0,15-0,20	0,20-0,30 0,20-0,25	0,20-0,30 0,25-0,30	0,30-0,40 0,25-0,35	0,40-0,50 0,30-0,40	0,40-0,60 0,30-0,40		
240-260					0,05-0,10 0,08-0,12	0,10-0,20 0,10-0,15	0,20-0,30 0,15-0,20	0,20-0,30 0,20-0,25	0,20-0,30 0,25-0,30	0,30-0,40 0,25-0,35	0,40-0,50 0,30-0,40	0,40-0,60 0,30-0,40		
220-240					0,05-0,10 0,08-0,12	0,10-0,20 0,10-0,15	0,20-0,30 0,15-0,20	0,20-0,30 0,20-0,25	0,20-0,30 0,25-0,30	0,30-0,40 0,25-0,35	0,40-0,50 0,30-0,40	0,40-0,60 0,30-0,40		
220-240					0,05-0,10 0,08-0,12	0,10-0,20 0,10-0,15	0,20-0,30 0,15-0,20	0,20-0,30 0,20-0,25	0,20-0,30 0,25-0,30	0,30-0,40 0,25-0,35	0,40-0,50 0,30-0,40	0,40-0,60 0,30-0,40		
220-240					0,05-0,10 0,08-0,12	0,10-0,20 0,10-0,15	0,20-0,30 0,15-0,20	0,20-0,30 0,20-0,25	0,20-0,30 0,25-0,30	0,30-0,40 0,25-0,35	0,40-0,50 0,30-0,40	0,40-0,60 0,30-0,40		
					0,05-0,10 0,08-0,12	0,10-0,20 0,10-0,15	0,20-0,30 0,15-0,20	0,20-0,30 0,20-0,25	0,20-0,30 0,25-0,30	0,30-0,40 0,25-0,35	0,40-0,50 0,30-0,40	0,40-0,60 0,30-0,40		
220-240					0,05-0,10 0,08-0,12	0,10-0,20 0,10-0,15	0,20-0,30 0,15-0,20	0,20-0,30 0,20-0,25	0,20-0,30 0,25-0,30	0,30-0,40 0,25-0,35	0,40-0,50 0,30-0,40	0,40-0,60 0,30-0,40		
240-260					0,05-0,10 0,08-0,12	0,10-0,20 0,10-0,15	0,20-0,30 0,15-0,20	0,20-0,30 0,20-0,25	0,20-0,30 0,25-0,30	0,30-0,40 0,25-0,35	0,40-0,50 0,30-0,40	0,40-0,60 0,30-0,40		
220-240			120-140	180-200	0,05-0,10 0,08-0,12	0,10-0,20 0,10-0,15	0,20-0,30 0,15-0,20	0,20-0,30 0,20-0,25	0,20-0,30 0,25-0,30	0,30-0,40 0,25-0,35	0,40-0,50 0,30-0,40	0,40-0,60 0,30-0,40	d x 0,02	d x 0,3-0,7
200-220			100-120	140-160	0,05-0,10 0,08-0,12	0,10-0,20 0,10-0,15	0,20-0,30 0,15-0,20	0,20-0,30 0,20-0,25	0,20-0,30 0,25-0,30	0,30-0,40 0,25-0,35	0,40-0,50 0,30-0,40	0,40-0,60 0,30-0,40		
400-500	400-500				0,05-0,10 0,08-0,12	0,10-0,20 0,10-0,15	0,20-0,30 0,15-0,20	0,20-0,30 0,20-0,25	0,20-0,30 0,25-0,30	0,30-0,40 0,25-0,35	0,40-0,50 0,30-0,40	0,40-0,60 0,30-0,40	d x 0,02	d x 0,3-0,7
300-400	300-400				0,05-0,10 0,08-0,12	0,10-0,20 0,10-0,15	0,20-0,30 0,15-0,20	0,20-0,30 0,20-0,25	0,20-0,30 0,25-0,30	0,30-0,40 0,25-0,35	0,40-0,50 0,30-0,40	0,40-0,60 0,30-0,40		
300-400	300-400				0,05-0,10 0,08-0,12	0,10-0,20 0,10-0,15	0,20-0,30 0,15-0,20	0,20-0,30 0,20-0,25	0,20-0,30 0,25-0,30	0,30-0,40 0,25-0,35	0,40-0,50 0,30-0,40	0,40-0,60 0,30-0,40		
250-300	250-300				0,05-0,10 0,08-0,12	0,10-0,20 0,10-0,15	0,20-0,30 0,15-0,20	0,20-0,30 0,20-0,25	0,20-0,30 0,25-0,30	0,30-0,40 0,25-0,35	0,40-0,50 0,30-0,40	0,40-0,60 0,30-0,40		
500-600					0,05-0,10 0,08-0,12	0,10-0,20 0,10-0,15	0,20-0,30 0,15-0,20	0,20-0,30 0,20-0,25	0,20-0,30 0,25-0,30	0,30-0,40 0,25-0,35	0,40-0,50 0,30-0,40	0,40-0,60 0,30-0,40		
300-400					0,05-0,10 0,08-0,12	0,10-0,20 0,10-0,15	0,20-0,30 0,15-0,20	0,20-0,30 0,20-0,25	0,20-0,30 0,25-0,30	0,30-0,40 0,25-0,35	0,40-0,50 0,30-0,40	0,40-0,60 0,30-0,40		
		600-800			0,05-0,10 0,08-0,12	0,10-0,20 0,10-0,15	0,20-0,30 0,15-0,20	0,20-0,30 0,20-0,25	0,20-0,30 0,25-0,30	0,30-0,40 0,25-0,35	0,40-0,50 0,30-0,40	0,40-0,60 0,30-0,40		
	100-120				0,05-0,10 0,08-0,12	0,10-0,20 0,10-0,15	0,20-0,30 0,15-0,20	0,20-0,30 0,20-0,25	0,20-0,30 0,25-0,30	0,30-0,40 0,25-0,35	0,40-0,50 0,30-0,40	0,40-0,60 0,30-0,40	d x 0,02	d x 0,3-0,7
	80-100				0,05-0,10 0,08-0,12	0,10-0,20 0,10-0,15	0,20-0,30 0,15-0,20	0,20-0,30 0,20-0,25	0,20-0,30 0,25-0,30	0,30-0,40 0,25-0,35	0,40-0,50 0,30-0,40	0,40-0,60 0,30-0,40		
80-100	80-100				0,05-0,10 0,08-0,12	0,10-0,20 0,10-0,15	0,20-0,30 0,15-0,20	0,20-0,30 0,20-0,25	0,20-0,30 0,25-0,30	0,30-0,40 0,25-0,35	0,40-0,50 0,30-0,40	0,40-0,60 0,30-0,40		
60-80	60-80				0,05-0,10 0,08-0,12	0,10-0,20 0,10-0,15	0,20-0,30 0,15-0,20	0,20-0,30 0,20-0,25	0,20-0,30 0,25-0,30	0,30-0,40 0,25-0,35	0,40-0,50 0,30-0,40	0,40-0,60 0,30-0,40		

Fräsen mit Wendeschneidplatten
Milling with indexable inserts

The cutting data indicated are starting values and must be adjusted to the prevailing conditions.

Schnittwertempfehlungen für Wechsellplatte WPV-N Schruppen Cutting data recommendations for indexable insert WPV-N Roughing

	Werkstoff	Material	Werkstoff-Nr. Material No.	DIN Bezeichnung Alt DIN Description Old	R _m /UTS (N/mm ²)	DIN Bezeichnung Neu DIN Description New	
P	Unlegierter Baustahl + Automatenstahl	Plain carbon steel + free cutting steel	1.0570	St52-3	-700	S355J2G3	
			1.1730	C45	-800	C45U	
			1.0715	9SMn28	-700	11SMn30	
				1.1191	Ck45	500-950	C45E
				1.7219	26CrMo4		26CrMo4-2
	Vergütungsstahl, mittelfest	Heat-treatment steel, medium strength	1.7225	42CrMo4	500-950	42CrMo4	
	Stahlguss	Cast steel	1.8159	51CrV4		51CrV4	
			1.0416	GS40	-950	GS40	
	Einsatzstahl	Case hardening steel	1.7131	16MnCr5	-950	16MnCr5	
	Rost- und säurebe- ständiger Stahl, ferritisch, martensitisch	Stainless steel, ferritic, martensitic	1.4006	X10Cr13	500-950	X12Cr13	
			1.4104	X12CrMoS17		X14CrMoS17	
			1.4122	X35CrMo17		X39CrMo17-1	
	Vergütungsstahl, hochfest	Heat-treatment steel, high strength	1.7225	42CrMo4	950-1400	42CrMo4	
	Nitrierstahl, vergütet	Nitriding steel, heat treated	1.6580	30CrNiMo8		30CrNiMo8	
	Werkzeugstahl	Tool steel	1.8504	34CrAl6	950-1400	34CrAl6	
1.2344			X40CrMoV5.1	-900	X40CrMoV5-1		
		1.2343	X38CrMoV5 1	950-1400	X37CrMoV5-1		
		1.2379	X155CrVMo12 1	-950	X153CrMoV12-1		
		1.2358	60CrMoV18-5	850-1000	60CrMoV18-5		
		1.2080	X210Cr12	950-1400	X210Cr12		
		1.2714	55NiCrMoV7	1100-1350	55NiCrMoV7		
		1.2311	40CrMnMo7	-1100	40CrMnMo7		
		1.2312	40CrMnNiMoS8.6	-1150	40CrMnNiMoS8-6		
		1.2316	X38CrMo16	-1100	X38CrMo16		
		1.2738	45CrMnNiMo8.6.4	950-1150	45CrMnNiMo8-6-4		
M	Rost- und säurebe- ständiger Stahl, austenitisch	Stainless steel, austenitic	1.4301	X2CrNiMo17-12-2	500-950	X5CrNiMo18-10	
			1.4404	X6CrNiMoTi17-12-2		X2CrNiMo17-12-2	
			1.4571	X10CrNiMoTi18		X10CrNiMoTi18	
Rost- und säurebe- ständiger Stahl, martensitisch aushärtbar	Stainless steel, martensitic steel	1.2709	X3NiCoMoTi18-9-5	800-1000	X3NiCoMoTi18-9-5		
		1.4542	X5CrNiCuNb16-4		X5CrNiCuNb16-4		
		1.4568	X7CrNiAl17-7		X7CrNiAl17-7		
K	Grauguss	Grey cast iron	0.6025	GG25	100-400 (120-260 HB)	EN-GJL-250	
	Legierter Grauguss	Alloyed grey cast iron	0.6678	GGL-NiCr35 2	150-250 (160-230 HB)	EN-GJLA-XNICr35-2	
	Sphäroguss	Nodular cast iron	0.7060	GGG60	400-800	EN-GJS-600-3	
			0.7070	GGG70L	(120-310 HB)	EN-GJS-700-2U	
Temperguss	Malleable cast iron	0.8155	GTS55	350-700 (150-280 HB)	EN-GJMB-550-4		
N	Aluminium-Legierungen, kurzspanend	Aluminium alloys, short chipping	3.2581	G-AISi12	-400	G-IGK-AISi12	
	Aluminium-Legierungen, langspanend	Aluminium alloys, long chipping	3.3535	AlMg3	-550	AlMg3	
			3.4365	AlZnMgCu1,5		AlZnMgCu1,5	
	Kupfer-Legierungen, kurzspanend	Copper alloys, short chipping	2.0402	MS58	-500	CuZn40Pb2	
	Kupfer-Legierungen, langspanend	Copper alloys, long chipping	2.0320	MS63	300-500	CuZn37	
			2.0975	CuAl10Ni		CuAl10Fe5Ni5-C	
	Thermoplaste	Thermoplastics		PVC	40-70	PVC	
	Duroplaste	Duroplastics		Bakelit, Melamin	20-40	Bakelit, Melamin	
S	Titan-Legierungen, mittelfest	Titanium alloys, medium strength	3.7115	TiAl5Sn2,5	-950	TiAl5Sn2-5	
			3.7164	TiAl6V4		TiAl6V4	
	Titan-Legierungen, hochfest	Titanium alloys, high strength	3.7174	TiAl6Sn2	900-1400	TiAl6V6Sn2	
	Nickelbasis-Legierungen, mittelfest	Nickel based alloys, medium strength	2.4670	NiCr12Al6MoNb	-950	NiCr12Al6MoNb	
	Nickelbasis-Legierungen, hochwarmfest	Heat resistant nickel based alloys, high strength	2.4668	NiCr19Fe19NbMo	900-1400	Inconel 718 NiCr19Fe19Nb5Mo3	
	Kobalt-Chrom-Legierung	Cobalt chromium alloys					
H	Hartguss	Chilled cast iron		Ni-hard, Ampco	300-600 HB	Ni-hard, Ampco	
	Gehärteter Stahl	Hardened steel			45-52 HRC		
					53-59 HRC		
				60-65 HRC			

Die angegebenen Schnittwerte sind Startwerte und müssen auf die vorhandenen Bedingungen abgestimmt werden.

Schnittgeschwindigkeit Cutting speed v_c (m/min)		Vorschub pro Zahn Feed per tooth f_z (mm/z.)								WPV a_p max I Maß 	a_e Schruppen step (Kontur) Roughing step (Contour)	a_e Schruppen Ebene Roughing plane		
		$\varnothing 8$	$\varnothing 10$	$\varnothing 12$	$\varnothing 16$	$\varnothing 20$	$\varnothing 25$	$\varnothing 32$						
WPV-N LCKP10M	WPV-N LCP40M	a_p max f_z max	a_p max f_z max	a_p max f_z max	a_p max f_z max	a_p max f_z max	a_p max f_z max	a_p max f_z max	a_p max f_z max					
180-200	160-180	1,00-1,50 0,25	1,00-2,00 0,30	1,50-2,00 0,35	1,50-3,00 0,40	1,50-4,00 0,45	2,00-4,00 0,45	2,00-4,00 0,50			0,1-0,3	d x 0,3 - d x 0,5		
180-200	160-180	1,00-1,50 0,25	1,00-2,00 0,30	1,50-2,00 0,35	1,50-3,00 0,40	1,50-4,00 0,45	2,00-4,00 0,45	2,00-4,00 0,50						
180-200	160-180	1,00-1,50 0,25	1,00-2,00 0,30	1,50-2,00 0,35	1,50-3,00 0,40	1,50-4,00 0,45	2,00-4,00 0,45	2,00-4,00 0,50						
180-200	160-180	1,00-1,50 0,25	1,00-2,00 0,30	1,50-2,00 0,35	1,50-3,00 0,40	1,50-4,00 0,45	2,00-4,00 0,45	2,00-4,00 0,50						
180-200	160-180	1,00-1,50 0,25	1,00-2,00 0,30	1,50-2,00 0,35	1,50-3,00 0,40	1,50-4,00 0,45	2,00-4,00 0,45	2,00-4,00 0,50						
180-200	160-180	1,00-1,50 0,25	1,00-2,00 0,30	1,50-2,00 0,35	1,50-3,00 0,40	1,50-4,00 0,45	2,00-4,00 0,45	2,00-4,00 0,50						
160-180	140-160	1,00-1,50 0,25	1,00-2,00 0,30	1,50-2,00 0,35	1,50-3,00 0,40	1,50-4,00 0,45	2,00-4,00 0,45	2,00-4,00 0,50						
140-160	120-140	1,00-1,50 0,25	1,00-2,00 0,30	1,50-2,00 0,35	1,50-3,00 0,40	1,50-4,00 0,45	2,00-4,00 0,45	2,00-4,00 0,50						
140-160	120-140	1,00-1,50 0,25	1,00-2,00 0,30	1,50-2,00 0,35	1,50-3,00 0,40	1,50-4,00 0,45	2,00-4,00 0,45	2,00-4,00 0,50						
180-200	160-180	1,00-1,50 0,25	1,00-2,00 0,30	1,50-2,00 0,35	1,50-3,00 0,40	1,50-4,00 0,45	2,00-4,00 0,45	2,00-4,00 0,50						
140-160	120-140	0,80-1,50 0,25	1,00-2,00 0,30	1,50-2,00 0,35	1,50-3,00 0,40	1,50-4,00 0,45	2,00-4,00 0,45	2,00-4,00 0,50					0,1-0,3	d x 0,3 - d x 0,5
120-140	100-120	0,80-1,50 0,25	1,00-2,00 0,30	1,50-2,00 0,35	1,50-3,00 0,40	1,50-4,00 0,45	2,00-4,00 0,45	2,00-4,00 0,50						
160-180		1,00-1,50 0,25	1,00-2,00 0,30	1,50-2,00 0,35	1,50-3,00 0,40	1,50-4,00 0,45	2,00-4,00 0,45	2,00-4,00 0,50		0,1-0,3	d x 0,3 - d x 0,5			
140-160		1,00-1,50 0,25	1,00-2,00 0,30	1,50-2,00 0,35	1,50-3,00 0,40	1,50-4,00 0,45	2,00-4,00 0,45	2,00-4,00 0,50						
180-200	160-180	1,00-1,50 0,25	1,00-2,00 0,30	1,50-2,00 0,35	1,50-3,00 0,40	1,50-4,00 0,45	2,00-4,00 0,45	2,00-4,00 0,50						
160-180	140-160	1,00-1,50 0,25	1,00-2,00 0,30	1,50-2,00 0,35	1,50-3,00 0,40	1,50-4,00 0,45	2,00-4,00 0,45	2,00-4,00 0,50						
180-200	160-180	1,00-1,50 0,25	1,00-2,00 0,30	1,50-2,00 0,35	1,50-3,00 0,40	1,50-4,00 0,45	2,00-4,00 0,45	2,00-4,00 0,50		0,1-0,3	d x 0,3 - d x 0,5			
140-160	120-140	1,00-1,50 0,25	1,00-2,00 0,30	1,50-2,00 0,35	1,50-3,00 0,40	1,50-4,00 0,45	2,00-4,00 0,45	2,00-4,00 0,50						

Fräsen mit Wendeschneidplatten
Milling with indexable inserts

The cutting data indicated are starting values and must be adjusted to the prevailing conditions.

Schnittwertempfehlungen für Wechsellplatte WPV-N Schlichten

Cutting data recommendations for indexable insert WPV-N Finishing

	Werkstoff	Material	Werkstoff-Nr. Material No.	DIN Bezeichnung Alt DIN Description Old	R _m /UTS (N/mm ²)	DIN Bezeichnung Neu DIN Description New
P	Unlegierter Baustahl + Automatenstahl	Plain carbon steel + free cutting steel	1.0570	St52-3	-700	S355J2G3
			1.1730	C45	-800	C45U
			1.0715	9SMn28	-700	11SMn30
			1.1191 1.7219	Ck45 26CrMo4	500-950	C45E 26CrMo4-2
	Vergütungsstahl, mittelfest	Heat-treatment steel, medium strength	1.7225 1.8159	42CrMo4 51CrV4	500-950	42CrMo4 51CrV4
	Stahlguss	Cast steel	1.0416	GS40	-950	GS40
	Einsatzstahl	Case hardening steel	1.7131	16MnCr5	-950	16MnCr5
	Rost- und säurebe- ständiger Stahl, ferritisch, martensitisch	Stainless steel, ferritic, martensitic	1.4006	X10Cr13	500-950	X12Cr13
			1.4104 1.4122	X12CrMoS17 X35CrMo17		X14CrMoS17 X39CrMo17-1
	Vergütungsstahl, hochfest	Heat-treatment steel, high strength	1.7225 1.6580	42CrMo4 30CrNiMo8	950-1400	42CrMo4 30CrNiMo8
	Nitrierstahl, vergütet	Nitriding steel, heat treated	1.8504 1.2344	34CrAl6 X40CrMoV5.1	950-1400 -900	34CrAl6 X40CrMoV5-1
	Werkzeugstahl	Tool steel	1.2343	X38CrMoV5 1	950-1400	X37CrMoV5-1
			1.2379	X155CrVMo12 1	-950	X153CrMoV12-1
			1.2358	60CrMoV18-5	850-1000	60CrMoV18-5
1.2080			X210Cr12	950-1400	X210Cr12	
1.2714			55NiCrMoV7	1100-1350	55NiCrMoV7	
1.2311			40CrMnMo7	-1100	40CrMnMo7	
1.2312			40CrMnNiMoS8.6	-1150	40CrMnNiMoS8-6	
1.2316 1.2738			X38CrMo16 45CrMnNiMo8.6.4	-1100 950-1150	X38CrMo16 45CrMnNiMo8-6-4	
M	Rost- und säurebe- ständiger Stahl, austenitisch	Stainless steel, austenitic	1.4301	X2CrNiMo17-12-2	500-950	X5CrNiMo18-10
			1.4404	X6CrNiMoTi17-12-2		X2CrNiMo17-12-2
			1.4571	X10CrNiMoTi18		X10CrNiMoTi18
Rost- und säurebe- ständiger Stahl, martensitisch aushärtbar	Stainless steel, martensitic steel	1.2709	X3NiCoMoTi18-9-5	800-1000	X3NiCoMoTi18-9-5	
		1.4542 1.4568	X5CrNiCuNb16-4 X7CrNiAl17-7		X5CrNiCuNb16-4 X7CrNiAl17-7	
K	Grauguss	Grey cast iron	0.6025	GG25	100-400 (120-260 HB)	EN-GJL-250
			0.6678	GGL-NiCr35 2	150-250 (160-230 HB)	EN-GJLA-XNICr35-2
	Sphäroguss	Nodular cast iron	0.7060	GGG60	400-800 (120-310 HB)	EN-GJS-600-3
			0.7070	GGG70L		EN-GJS-700-2U
Temperguss	Malleable cast iron	0.8155	GTS55	350-700 (150-280 HB)	EN-GJMB-550-4	
N	Aluminium-Legierungen, kurzspanend	Aluminium alloys, short chipping	3.2581	G-AlSi12	-400	G-IGK-AlSi12
	Aluminium-Legierungen, langspanend	Aluminium alloys, long chipping	3.3535	AlMg3	-550	AlMg3
			3.4365	AlZnMgCu1,5		AlZnMgCu1,5
	Kupfer-Legierungen, kurzspanend	Copper alloys, short chipping	2.0402	MS58	-500	CuZn40Pb2
			2.0320 2.0975	MS63 CuAl10Ni		300-500
	Thermoplaste	Thermoplastics		PVC	40-70	PVC
	Duroplaste	Duroplastics		Bakelit, Melamin	20-40	Bakelit, Melamin
	Graphit	Graphite				
Zirkonoxidkeramik	Zircon oxide ceramics					
S	Titan-Legierungen, mittelfest	Titanium alloys, medium strength	3.7115 3.7164	TiAl5Sn2,5 TiAl6V4	-950	TiAl5Sn2-5 TiAl6V4
	Titan-Legierungen, hochfest	Titanium alloys, high strength	3.7174	TiAl6Sn2	900-1400	TiAl6V6Sn2
	Nickelbasis-Legierungen, mittelfest	Nickel based alloys, medium strength	2.4670	NiCr12Al6MoNb	-950	NiCr12Al6MoNb
	Nickelbasis-Legierungen, hochwarmfest	Heat resistant nickel based alloys, high strength	2.4668	NiCr19Fe19NbMo	900-1400	Inconel 718 NiCr19Fe19Nb5Mo3
	Kobalt-Chrom-Legierung	Cobalt chromium alloys				
H	Hartguss	Chilled cast iron		Ni-hard, Ampco	300-600 HB	Ni-hard, Ampco
	Gehärteter Stahl	Hardened steel			45-52 HRC	
					53-59 HRC 60-65 HRC	

Die angegebenen Schnittwerte sind Startwerte und müssen auf die vorhandenen Bedingungen abgestimmt werden.

Schnittgeschwindigkeit Cutting speed v_c (m/min)	Vorschub pro Zahn Feed per tooth f_z (mm/z.)							a_e Schlichten step (Kontur) Finishing step (Contour)	a_e Schlichten Ebene Finishing plane
	Ø 8	Ø 10	Ø 12	Ø 16	Ø 20	Ø 25	Ø 32		
WPV-N LCKP10M	a_p max f_z max	a_p max f_z max	a_p max f_z max	a_p max f_z max	a_p max f_z max	a_p max f_z max	a_p max f_z max		
220–240	0,10–0,20 0,10–0,15	0,20–0,30 0,15–0,20	0,20–0,30 0,20–0,25	0,20–0,30 0,20–0,25	0,30–0,40 0,20–0,25	0,40–0,50 0,20–0,30	0,40–0,60 0,20–0,30	d x 0,02	d x 0,3 – d x 0,7
220–240	0,10–0,20 0,10–0,15	0,20–0,30 0,15–0,20	0,20–0,30 0,20–0,25	0,20–0,30 0,20–0,25	0,30–0,40 0,20–0,25	0,40–0,50 0,20–0,30	0,40–0,60 0,20–0,30		
220–240	0,10–0,20 0,10–0,15	0,20–0,30 0,15–0,20	0,20–0,30 0,20–0,25	0,20–0,30 0,20–0,25	0,30–0,40 0,20–0,25	0,40–0,50 0,20–0,30	0,40–0,60 0,20–0,30		
220–240	0,10–0,20 0,10–0,15	0,20–0,30 0,15–0,20	0,20–0,30 0,20–0,25	0,20–0,30 0,20–0,25	0,30–0,40 0,20–0,25	0,40–0,50 0,20–0,30	0,40–0,60 0,20–0,30		
240–260	0,10–0,20 0,10–0,15	0,20–0,30 0,15–0,20	0,20–0,30 0,20–0,25	0,20–0,30 0,20–0,25	0,30–0,40 0,20–0,25	0,40–0,50 0,20–0,30	0,40–0,60 0,20–0,30		
220–240	0,10–0,20 0,10–0,15	0,20–0,30 0,15–0,20	0,20–0,30 0,20–0,25	0,20–0,30 0,20–0,25	0,30–0,40 0,20–0,25	0,40–0,50 0,20–0,30	0,40–0,60 0,20–0,30		
200–240	0,10–0,20 0,10–0,15	0,20–0,30 0,15–0,20	0,20–0,30 0,20–0,25	0,20–0,30 0,20–0,25	0,30–0,40 0,20–0,25	0,40–0,50 0,20–0,30	0,40–0,60 0,20–0,30		
200–220	0,10–0,20 0,10–0,15	0,20–0,30 0,15–0,20	0,20–0,30 0,20–0,25	0,20–0,30 0,20–0,25	0,30–0,40 0,20–0,25	0,40–0,50 0,20–0,30	0,40–0,60 0,20–0,30		
220–240	0,10–0,20 0,10–0,15	0,20–0,30 0,15–0,20	0,20–0,30 0,20–0,25	0,20–0,30 0,20–0,25	0,30–0,40 0,20–0,25	0,40–0,50 0,20–0,30	0,40–0,60 0,20–0,30		
240–280	0,10–0,20 0,10–0,15	0,20–0,30 0,15–0,20	0,20–0,30 0,20–0,25	0,20–0,30 0,20–0,25	0,30–0,40 0,20–0,25	0,40–0,50 0,20–0,30	0,40–0,60 0,20–0,30		
200–220	0,10–0,20 0,10–0,15	0,20–0,30 0,15–0,20	0,20–0,30 0,20–0,25	0,20–0,30 0,20–0,25	0,30–0,40 0,20–0,25	0,40–0,50 0,20–0,30	0,40–0,60 0,20–0,30	d x 0,02	d x 0,3 – d x 0,7
200–220	0,10–0,20 0,10–0,15	0,20–0,30 0,15–0,20	0,20–0,30 0,20–0,25	0,20–0,30 0,20–0,25	0,30–0,40 0,20–0,25	0,40–0,50 0,20–0,30	0,40–0,60 0,20–0,30		
240–260	0,10–0,20 0,10–0,15	0,20–0,30 0,15–0,20	0,20–0,30 0,20–0,25	0,20–0,30 0,20–0,25	0,30–0,40 0,20–0,25	0,40–0,50 0,20–0,30	0,40–0,60 0,20–0,30		
220–240	0,10–0,20 0,10–0,15	0,20–0,30 0,15–0,20	0,20–0,30 0,20–0,25	0,20–0,30 0,20–0,25	0,30–0,40 0,20–0,25	0,40–0,50 0,20–0,30	0,40–0,60 0,20–0,30		
120–140	0,10–0,15 0,08–0,12	0,12–0,18 0,10–0,12	0,15–0,20 0,12–0,18	0,18–0,25 0,15–0,20	0,18–0,25 0,18–0,22	0,20–0,30 0,20–0,25	0,30–0,40 0,30–0,35	d x 0,15–0,18	d x 0,1 – d x 0,3
220–240	0,10–0,20 0,10–0,15	0,20–0,30 0,15–0,20	0,20–0,30 0,20–0,25	0,20–0,30 0,20–0,25	0,30–0,40 0,20–0,25	0,40–0,50 0,20–0,30	0,40–0,60 0,20–0,30	d x 0,02	d x 0,3 – d x 0,7
180–200	0,10–0,20 0,10–0,15	0,20–0,30 0,15–0,20	0,20–0,30 0,20–0,25	0,20–0,30 0,20–0,25	0,30–0,40 0,20–0,25	0,40–0,50 0,20–0,30	0,40–0,60 0,20–0,30	d x 0,15–0,18	d x 0,1 – d x 0,3
120–140	0,10–0,15 0,08–0,12	0,12–0,18 0,10–0,12	0,15–0,20 0,12–0,18	0,18–0,25 0,15–0,20	0,18–0,25 0,18–0,22	0,20–0,30 0,20–0,25	0,30–0,40 0,30–0,35	d x 0,15–0,18	d x 0,1 – d x 0,3

The cutting data indicated are starting values and must be adjusted to the prevailing conditions.

							Schneidstoffsorten										Für Fräser For cutter					
							Cutting materials															
							Ident No.															
N = Anzahl der Schneidkanten N = Number of cutting edges	LMT-Code	l	d	s	d ₁	r _{theo.}	LWP40M	LWNS30M	LWNS10M	LWNS33M	LCP40M	LCPK30M	LCPK10M	LCPK25M	LCPK15M	LCKP10M	LCHK10M	LCH33M	LCN10M	LDN10M	Cat-No.	
<p>N = 2</p>	WPB 06 HF	8	6	1,6	2,5	0,6		7245032	7016142 ¹⁾			7245030	9200283 ¹⁾	7214333							EBG R 06	
	WPB 08 HF	9,5	8	2	3	0,8		7245033	7016143 ¹⁾			7132044	9200268 ¹⁾	7214334							EBG V 08	
	WPB 10 HF	11,5	10	2,5	4	1,0		7245034	7016144 ¹⁾			7132045	9103211 ¹⁾	7214335							EBG V 10	
	WPB 12 HF	14	12	2,5	5	1,2		7245035	7016145			6132176		7214336							EBG V 12	
	WPB 16 HF	16	16	3	5	1,6		7016148				6132180		7214337							EBG V 16	
	WPB 20 HF	18	20	3	5	2,0		7016150				6132182		7214338							EBG V 20	
	WPB 25 HF	23,5	25	4	6	2,5		9087093					6183263 ¹⁾	7214339							EBG V 25	
	WPB 32 HF	26,5	32	5	8	3,2		7245031					6183264 ¹⁾	7214340							EBG V 32	
																					P	
																						M
																						K
																						N
																						S
																						H

¹⁾ nur noch lieferbar solange Vorrat reicht (Ersatz: LWNS30M, LCPK30M)
 only available while stock last (replacement: LWNS30M, LCPK30M)

■ = Hauptanwendung First choice
 □ = Nebenanwendung Alternative

Sortenbeschreibung/-bezeichnung und ISO-Code ab Seite 424/477
 Description/Designation of grades and ISO-Code starting page 424/477

Alle WPR-, WPV- und WPB-Wendepalten sind in der Sorte LCN10M (diamantbeschichtet) oder PKD/CBN-bestückt auf Anfrage lieferbar.
 All WPR, WPV and WPB inserts are available in grade LCN10M (diamond coated) or PCD/CBN tipped.

HRC > 58 CBN							Schneidstoffsorten Cutting materials Ident No.										Für Fräser For cutter				
N = Anzahl der Schneidkanten N = Number of cutting edges	ISO-Code	l	d	s	d ₁	r	LWP40M	LWNS30M	LWNS10M	LWNS33M	LCP40M	LCPK30M	LCPK10M	LCPK25M	LCPK15M	LCKP10M	LCHK10M	LCH33M	LBHK95M	Cat-No.	
<p>N = 2</p>	WPB 06 FB 20	8	6	1,6	2,5	2										9112332					EBG R 06
	WPB 08 FB 30	9,5	8	2	3	3										9112328					EBG R 08
	WPB 10 FB 40	11,5	10	2,5	4	4										9097607					EBG R 10
	WPB 12 FB 50	14	12	2,5	5	5										9097606			9078092		EBG R 12
	WPB 16 FB 70	16	16	3	5	7										9095870			9078091		EBG R 16
	WPB 20 FB 90	18	20	3	5	9										9097608			9080149		EBG R 20

■ = Hauptanwendung First choice
 □ = Nebenanwendung Alternative

Sortenbeschreibung/-bezeichnung und ISO-Code ab Seite 424/477
 Description/Designation of grades and ISO-Code starting page 424/477

Alle WPR-, WPV- und WPB-Wendepplatten sind in der Sorte LCN10M (diamantbeschichtet) oder PKD/CBN-bestückt auf Anfrage lieferbar.
 All WPR, WPV and WPB inserts are available in grade LCN10M (diamond coated) or PCD/CBN tipped.

																■					P
																□					M
																■			■		K
																					N
																					S
																□			■		H

Fräser mit Wendeschneidplatten
Milling with indexable inserts

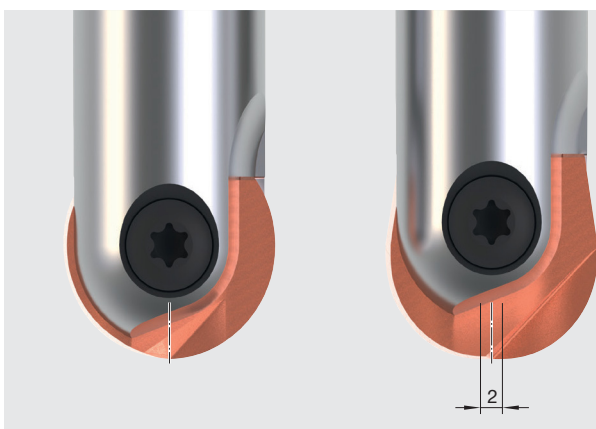

FlatBall® Eigenschaften und Vorteile:

- Keine Schnittgeschwindigkeit Null im Zentrum
- Deutlich geringerer Erstverschleiß im Zentrum
- Geeignet für flache Konturbereiche
- Bei gleichem a_e verbesserte Oberfläche
- Bei höherem a_e geringere Bearbeitungszeit

FlatBall® features and benefits:

- No zero cutting speed in center
- Significant reduction of wear in center
- Suitable for flat contours
- Improved surface finish at same a_e
- Less machining time at higher a_e

Schnittwertempfehlungen für Wechsellatte WPB-HF Schruppen Cutting data recommendations for indexable insert WPB-HF Roughing

	Werkstoff	Material	Werkstoff-Nr. Material No.	DIN Bezeichnung Alt DIN Description Old	R _m /UTS (N/mm ²)	DIN Bezeichnung Neu DIN Description New
P	Unlegierter Baustahl + Automatenstahl	Plain carbon steel + free cutting steel	1.0570	St52-3	-700	S355J2G3
			1.1730	C45	-800	C45U
			1.0715	9SMn28	-700	11SMn30
			1.1191	Ck45	500-950	C45E
			1.7219	26CrMo4	500-950	26CrMo4-2
	Vergütungsstahl, mittelfest	Heat-treatment steel, medium strength	1.7225	42CrMo4	500-950	42CrMo4
			1.8159	51CrV4		51CrV4
	Stahlguss	Cast steel	1.0416	GS40	-950	GS40
	Einsatzstahl	Case hardening steel	1.7131	16MnCr5	-950	16MnCr5
	Rost- und säurebe- ständiger Stahl, ferritisch, martensitisch	Stainless steel, ferritic, martensitic	1.4006	X10Cr13	500-950	X12Cr13
			1.4104	X12CrMoS17		X14CrMoS17
			1.4122	X35CrMo17		X39CrMo17-1
	Vergütungsstahl, hochfest	Heat-treatment steel, high strength	1.7225	42CrMo4	950-1400	42CrMo4
			1.6580	30CrNiMo8		30CrNiMo8
	Nitrierstahl, vergütet	Nitriding steel, heat treated	1.8504	34CrAl6	950-1400	34CrAl6
1.2344			X40CrMoV5.1	-900	X40CrMoV5-1	
Werkzeugstahl	Tool steel	1.2343	X38CrMoV5 1	950-1400	X37CrMoV5-1	
		1.2379	X155CrVMo12 1	-950	X153CrMoV12-1	
		1.2358	60CrMoV18-5	850-1000	60CrMoV18-5	
		1.2080	X210Cr12	950-1400	X210Cr12	
		1.2714	55NiCrMoV7	1100-1350	55NiCrMoV7	
		1.2311	40CrMnMo7	-1100	40CrMnMo7	
		1.2312	40CrMnNiMoS8.6	-1150	40CrMnNiMoS8-6	
		1.2316	X38CrMo16	-1100	X38CrMo16	
1.2738	45CrMnNiMo8.6.4	950-1150	45CrMnNiMo8-6-4			
M	Rost- und säurebe- ständiger Stahl, austenitisch	Stainless steel, austenitic	1.4301	X2CrNiMo17-12-2	500-950	X5CrNiMo18-10
			1.4404	X6CrNiMoTi17-12-2		X2CrNiMo17-12-2
			1.4571	X10CrNiMoTi18		X10CrNiMoTi18
Rost- und säurebe- ständiger Stahl, martensitisch aushärtbar	Stainless steel, martensitic steel		1.2709	X3NiCoMoTi18-9-5	800-1000	X3NiCoMoTi18-9-5
			1.4542	X5CrNiCuNb16-4		X5CrNiCuNb16-4
			1.4568	X7CrNiAl17-7		X7CrNiAl17-7
K	Grauguss	Grey cast iron	0.6025	GG25	100-400 (120-260 HB)	EN-GJ1-250
			0.6678	GGL-NiCr35 2	150-250 (160-230 HB)	EN-GJLA-XNiCr35-2
	Sphäroguss	Nodular cast iron	0.7060	GGG60	400-800	EN-GJS-600-3
			0.7070	GGG70L	(120-310 HB)	EN-GJS-700-2U
Temperguss	Malleable cast iron	0.8155	GTS55	350-700 (150-280 HB)	EN-GJMB-550-4	
N	Aluminium-Legierungen, kurzspanend	Aluminium alloys, short chipping	3.2581	G-AlSi12	-400	G-IGK-AlSi12
	Aluminium-Legierungen, langspanend	Aluminium alloys, long chipping	3.3535	AlMg3	-550	AlMg3
	Kupfer-Legierungen, kurzspanend	Copper alloys, short chipping	2.0402	MS58	-500	CuZn40Pb2
	Kupfer-Legierungen, langspanend	Copper alloys, long chipping	2.0320	MS63	300-500	CuZn37
	Thermoplaste	Thermoplastics	2.0975	CuAl10Ni		CuAl10Fe5Ni5-C
	Duroplaste	Duroplastics		PVC	40-70	PVC
	Graphit	Graphite		Bakelit, Melamin	20-40	Bakelit, Melamin
	Zirkonoxidkeramik	Zircon oxide ceramics				
S	Titan-Legierungen, mittelfest	Titanium alloys, medium strength	3.7115	TiAl5Sn2,5	-950	TiAl5Sn2-5
			3.7164	TiAl6V4		Ti6AlV4
	Titan-Legierungen, hochfest	Titanium alloys, high strength	3.7174	TiAl6Sn2	900-1400	TiAl6V6Sn2
	Nickelbasis-Legierungen, mittelfest	Nickel based alloys, medium strength	2.4670	NiCr12Al6MoNb	-950	NiCr12Al6MoNb
	Nickelbasis-Legierungen, hochwarmfest	Heat resistant nickel based alloys, high strength	2.4668	NiCr19Fe19NbMo	900-1400	Inconel 718 NiCr19Fe19Nb5Mo3
Kobalt-Chrom-Legierung	Cobalt chromium alloys					
H	Hartguss	Chilled cast iron		Ni-hard, Ampco	300-600 HB	Ni-hard, Ampco
	Gehärteter Stahl	Hardened steel			45-52 HRC	
					53-59 HRC	
				60-65 HRC		

Die angegebenen Schnittwerte sind Startwerte und müssen auf die vorhandenen Bedingungen abgestimmt werden.

Schnittgeschwindigkeit Cutting speed v_c (m/min)				Vorschub pro Zahn Feed per tooth f_z (mm/z.)									a_e Schruppen Roughing
				$\emptyset 6$	$\emptyset 8$	$\emptyset 10$	$\emptyset 12$	$\emptyset 16$	$\emptyset 20$	$\emptyset 25$	$\emptyset 32$		
WPB-HF LCPK30M	WPB-HF LCPK10M LCPK25M	WPB-HF LWNS10M	WPB-HF LWNS30M	a_p max f_z max	a_p max f_z max	a_p max f_z max	a_p max f_z max	a_p max f_z max	a_p max f_z max	a_p max f_z max	a_p max f_z max	a_p max f_z max	max. 70 %
180-200	180-200			0,30 0,30	0,40 0,40	0,50 0,50	0,60 0,60	0,80 0,80	1,00 1,20	1,20 1,50	1,50 1,50	d x 0,7	
180-200	180-200			0,30 0,30	0,40 0,40	0,50 0,50	0,60 0,60	0,80 0,80	1,00 1,20	1,20 1,50	1,50 1,50		
180-200	180-200			0,30 0,30	0,40 0,40	0,50 0,50	0,60 0,60	0,80 0,80	1,00 1,20	1,20 1,50	1,50 1,50		
180-200	180-200			0,30 0,30	0,40 0,40	0,50 0,50	0,60 0,60	0,80 0,80	1,00 1,20	1,20 1,50	1,50 1,50		
180-200	180-200			0,30 0,30	0,40 0,40	0,50 0,50	0,60 0,60	0,80 0,80	1,00 1,20	1,20 1,50	1,50 1,50		
180-200	180-200			0,40 0,30	0,60 0,30	0,80 0,40	0,80 0,50	1,00 0,60	1,00 0,80	1,30 1,00	1,50 1,25		
160-180	160-180			0,25 0,30	0,30 0,30	0,40 0,40	0,50 0,50	0,60 0,60	0,80 0,80	1,30 1,00	1,50 1,25		
140-160	140-160			0,25 0,30	0,30 0,30	0,40 0,40	0,50 0,50	0,60 0,60	0,80 0,80	1,30 1,00	1,50 1,25		
140-160	140-160			0,30 0,30	0,40 0,40	0,50 0,40	0,60 0,50	0,80 0,60	1,00 0,80	1,20 1,00	1,50 1,20		
180-200	180-200			0,30 0,30	0,40 0,40	0,50 0,50	0,60 0,60	0,80 0,80	1,00 1,20	1,20 1,50	1,50 1,50		
140-160	140-160			0,30 0,30	0,40 0,30	0,50 0,40	0,60 0,60	0,80 0,80	1,00 1,00	1,20 1,20	1,50 1,50		d x 0,7
140-160	140-160			0,30 0,30	0,40 0,30	0,50 0,40	0,60 0,60	0,80 0,80	1,00 1,00	1,20 1,20	1,50 1,50		
180-200	180-200			0,30 0,30	0,40 0,30	0,50 0,40	0,60 0,50	0,80 0,60	1,00 0,80	1,20 1,00	1,50 1,25	d x 0,7	
180-200	180-200			0,40 0,30	0,60 0,30	0,80 0,40	0,80 0,50	1,00 0,60	1,00 0,80	1,30 1,00	1,50 1,25		
180-200	180-200			0,40 0,30	0,60 0,30	0,80 0,40	0,80 0,50	1,00 0,60	1,00 0,80	1,30 1,00	1,50 1,25		
180-200	180-200			0,40 0,30	0,60 0,30	0,80 0,40	0,80 0,50	1,00 0,60	1,00 0,80	1,30 1,00	1,50 1,25		
		400-500	400-500	0,40 0,30	0,60 0,30	0,80 0,40	0,80 0,50	1,00 0,60	1,00 0,80	1,30 1,00	1,50 1,25	d x 0,7	
		350-400	350-400	0,40 0,30	0,60 0,30	0,80 0,40	0,80 0,50	1,00 0,60	1,00 0,80	1,30 1,00	1,50 1,25		
		250-300	250-300	0,30 0,40	0,40 0,50	0,50 0,60	0,60 0,80	0,80 1,20	1,00 1,50	1,20 1,50	1,50 1,50		
		250-300	250-300	0,30 0,40	0,40 0,50	0,50 0,60	0,60 0,80	0,80 1,20	1,00 1,50	1,20 1,50	1,50 1,50		
		500-600	500-600	0,30 0,50	0,40 0,80	0,50 1,00	0,60 1,00	0,80 1,20	1,00 1,50	1,20 1,50	1,50 1,50		
80-100	80-100			0,20 0,25	0,30 0,30	0,40 0,35	0,40 0,40	0,50 0,50	0,50 0,60	0,60 0,80	0,80 1,00	d x 0,7	
60-80	60-80			0,20 0,25	0,30 0,30	0,40 0,35	0,40 0,40	0,50 0,50	0,50 0,60	0,60 0,80	0,80 1,00		
100-120	100-120			0,20 0,25	0,30 0,30	0,40 0,35	0,40 0,40	0,50 0,50	0,50 0,60	0,60 0,80	0,80 1,00		
80-100	80-100			0,20 0,25	0,30 0,30	0,40 0,35	0,40 0,40	0,50 0,50	0,50 0,60	0,60 0,80	0,80 1,00		
100-120	100-120			0,20 0,25	0,30 0,30	0,40 0,35	0,40 0,40	0,50 0,50	0,50 0,60	0,60 0,80	0,80 1,00	d x 0,7	
140-160	140-160			0,30 0,30	0,40 0,40	0,50 0,50	0,60 0,60	0,80 0,80	1,00 1,20	1,20 1,50	1,50 1,50		
80-100	80-100			0,20 0,25	0,30 0,30	0,40 0,35	0,40 0,40	0,50 0,50	0,50 0,60	0,60 0,80	0,80 1,00		

Fräsen mit Wertschneidplatten
Milling with indexable inserts

The cutting data indicated are starting values and must be adjusted to the prevailing conditions.

Schnittwertempfehlungen für Wechsellatte WPB-FB Schruppen
Cutting data recommendations for indexable insert WPB-FB Roughing

	Werkstoff	Material	Werkstoff-Nr. Material No.	DIN Bezeichnung Alt DIN Description Old	R_m/UTS (N/mm²)	DIN Bezeichnung Neu DIN Description New
P	Unlegierter Baustahl + Automatenstahl	Plain carbon steel + free cutting steel	1.0570	St52-3	-700	S355J2G3
			1.1730	C45	-800	C45U
			1.0715	9SMn28	-700	11SMn30
	Vergütungsstahl, mittelfest	Heat-treatment steel, medium strength	1.1191	Ck45	500-950	C45E
			1.7219	26CrMo4	500-950	26CrMo4-2
	Stahlguss	Cast steel	1.7225	42CrMo4	500-950	42CrMo4
			1.8159	51CrV4	-950	51CrV4
	Einsatzstahl	Case hardening steel	1.0416	GS40	-950	GS40
			1.7131	16MnCr5	-950	16MnCr5
	Rost- und säurebe- ständiger Stahl, ferritisch, martensitisch	Stainless steel, ferritic, martensitic	1.4006	X10Cr13	500-950	X12Cr13
			1.4104	X12CrMoS17	500-950	X14CrMoS17
	Vergütungsstahl, hochfest	Heat-treatment steel, high strength	1.4122	X35CrMo17	500-950	X39CrMo17-1
			1.7225	42CrMo4	950-1400	42CrMo4
	Nitrierstahl, vergütet	Nitriding steel, heat treated	1.6580	30CrNiMo8	950-1400	30CrNiMo8
			1.8504	34CrAl6	950-1400	34CrAl6
Werkzeugstahl	Tool steel	1.2344	X40CrMoV5.1	-900	X40CrMoV5-1	
		1.2343	X38CrMoV5 1	950-1400	X37CrMoV5-1	
		1.2379	X155CrVMo12 1	-950	X153CrMoV12-1	
		1.2358	60CrMoV18-5	850-1000	60CrMoV18-5	
		1.2080	X210Cr12	950-1400	X210Cr12	
		1.2714	55NiCrMoV7	1100-1350	55NiCrMoV7	
		1.2311	40CrMnMo7	-1100	40CrMnMo7	
		1.2312	40CrMnNiMoS8.6	-1150	40CrMnNiMoS8-6	
M	Rost- und säurebe- ständiger Stahl, austenitisch	Stainless steel, austenitic	1.2316	X38CrMo16	-1100	X38CrMo16
			1.2738	45CrMnNiMo8.6.4	950-1150	45CrMnNiMo8-6-4
			1.4301	X2CrNiMo17-12-2	500-950	X5CrNiMo18-10
Rost- und säurebe- ständiger Stahl, martensitisch aushärtbar	Stainless steel, martensitic steel	1.4404	X6CrNiMoTi17-12-2	500-950	X2CrNiMo17-12-2	
		1.4571	X10CrNiMoTi18	500-950	X10CrNiMoTi18	
		1.2709	X3NiCoMoTi18-9-5	800-1000	X3NiCoMoTi18-9-5	
K	Grauguss	Grey cast iron	1.4542	X5CrNiCuNb16-4	800-1000	X5CrNiCuNb16-4
			1.4568	X7CrNiAl17-7	800-1000	X7CrNiAl17-7
			0.6025	GG25	100-400 (120-260 HB)	EN-GJL-250
			0.6678	GGL-NiCr35 2	150-250 (160-230 HB)	EN-GJLA-XNiCr35-2
Sphäroguss	Nodular cast iron	0.7060	GGG60	400-800	EN-GJS-600-3	
		0.7070	GGG70L	(120-310 HB)	EN-GJS-700-2U	
Temperguss	Malleable cast iron	0.8155	GTS55	350-700 (150-280 HB)	EN-GJMB-550-4	
		0.8155	GTS55	350-700 (150-280 HB)	EN-GJMB-550-4	
N	Aluminium-Legierungen, kurzspanend	Aluminium alloys, short chipping	3.2581	G-AlSi12	-400	G-IGK-AlSi12
	Aluminium-Legierungen, langspanend	Aluminium alloys, long chipping	3.3535	AlMg3	-550	AlMg3
	Kupfer-Legierungen, kurzspanend	Copper alloys, short chipping	3.4365	AlZnMgCu1,5	-550	AlZnMgCu1,5
	Kupfer-Legierungen, langspanend	Copper alloys, long chipping	2.0402	MS58	-500	CuZn40Pb2
	Thermoplaste	Thermoplastics	2.0320	MS63	300-500	CuZn37
	Duroplaste	Duroplastics	2.0975	CuAl10Ni	300-500	CuAl10Fe5Ni5-C
	Graphit	Graphite		PVC	40-70	PVC
	Zirkonoxidkeramik	Zircon oxide ceramics		Bakelit, Melamin	20-40	Bakelit, Melamin
S	Titan-Legierungen, mittelfest	Titanium alloys, medium strength	3.7115	TiAl5Sn2,5	-950	TiAl5Sn2-5
	Titan-Legierungen, hochfest	Titanium alloys, high strength	3.7164	TiAl6V4	-950	TiAl6V4
	Nickelbasis-Legierungen, mittelfest	Nickel based alloys, medium strength	3.7174	TiAl6Sn2	900-1400	TiAl6V6Sn2
	Nickelbasis-Legierungen, hochwarmfest	Heat resistant nickel based alloys, high strength	2.4670	NiCr12Al6MoNb	-950	NiCr12Al6MoNb
	Kobalt-Chrom-Legierung	Cobalt chromium alloys	2.4668	NiCr19Fe19NbMo	900-1400	Inconel 718 NiCr19Fe19Nb5Mo3
H	Hartguss	Chilled cast iron		Ni-hard, Ampco	300-600 HB	Ni-hard, Ampco
	Gehärteter Stahl	Hardened steel			45-52 HRC	
					53-59 HRC	
					60-65 HRC	

Die angegebenen Schnittwerte sind Startwerte und müssen auf die vorhandenen Bedingungen abgestimmt werden.

Schnittgeschwindigkeit Cutting speed v_c (m/min)		Vorschub pro Zahn Feed per tooth f_z (mm/z.)						a_e Schlichten Finishing	
		$\varnothing 6$	$\varnothing 8$	$\varnothing 10$	$\varnothing 12$	$\varnothing 16$	$\varnothing 20$		
WPB-FB LCKP10M	WPB-FB LBHK95M	a_p max f_z max	a_p max f_z max	a_p max f_z max	a_p max f_z max	a_p max f_z max	a_p max f_z max	d x 0,05	
220-300		0,40 0,40	0,60 0,50	0,80 0,50	1,00 0,60	1,00 0,60	1,50 0,60		d x 0,05
220-300		0,40 0,40	0,60 0,50	0,80 0,50	1,00 0,60	1,00 0,60	1,50 0,60		
220-300		0,40 0,40	0,60 0,50	0,80 0,50	1,00 0,60	1,00 0,60	1,50 0,60		
260-340		0,40 0,40	0,60 0,50	0,80 0,50	1,00 0,60	1,00 0,60	1,50 0,60		
280-360		0,40 0,40	0,60 0,50	0,80 0,50	1,00 0,60	1,00 0,60	1,50 0,60		
220-300		0,40 0,40	0,60 0,50	0,80 0,50	1,00 0,60	1,00 0,60	1,50 0,60		
220-300		0,40 0,40	0,60 0,50	0,80 0,50	1,00 0,60	1,00 0,60	1,50 0,60		
200-280		0,40 0,40	0,60 0,50	0,80 0,50	1,00 0,60	1,00 0,60	1,50 0,60		
240-340		0,40 0,40	0,60 0,50	0,80 0,50	1,00 0,60	1,00 0,60	1,50 0,60		
250-360		0,40 0,40	0,60 0,50	0,80 0,50	1,00 0,60	1,00 0,60	1,50 0,60		
220-250		0,30 0,40	0,50 0,40	0,60 0,50	0,70 0,50	0,80 0,50	0,80 0,50	d x 0,05	
220-250		0,30 0,40	0,50 0,40	0,60 0,50	0,70 0,50	0,80 0,50	0,80 0,50		
280-350	600-1000	0,40	0,60	0,80	1,00	1,00	1,50	d x 0,05	
240-260		0,40	0,50	0,60	0,70	0,70	0,80		
260-330	400-800	0,40	0,60	0,80	1,00	1,00	1,50		
280-300		0,40	0,50	0,60	0,70	0,70	0,80		
380-400	600-1000	0,40	0,60	0,80	1,00	1,00	1,50		
340-360		0,40	0,50	0,60	0,70	0,70	0,80		
320-340		0,40	0,60	0,80	1,00	1,00	1,50		
280-300		0,40	0,50	0,60	0,70	0,70	0,80		
								d x 0,05	
								d x 0,05	
120-140		0,30 0,40	0,50 0,40	0,60 0,50	0,70 0,50	0,80 0,50	0,80 0,50		
100-120		0,30 0,40	0,50 0,40	0,60 0,50	0,70 0,50	0,80 0,50	0,80 0,50		
120-140		0,40 0,40	0,60 0,50	0,80 0,50	1,00 0,60	1,00 0,60	1,50 0,60	d x 0,05	
240-260	350-450	0,40 0,40	0,60 0,50	0,80 0,50	1,00 0,60	1,00 0,60	1,50 0,60		
220-240	300-380	0,40 0,40	0,60 0,50	0,80 0,50	1,00 0,60	1,00 0,60	1,50 0,60		
120-140	200-250	0,40 0,40	0,60 0,50	0,80 0,50	1,00 0,60	1,00 0,60	1,50 0,60		

The cutting data indicated are starting values and must be adjusted to the prevailing conditions.

Schnittwertempfehlungen für Wechsellplatte WPB-FB Schlichten
Cutting data recommendations for indexable insert WPB-FB Finishing

	Werkstoff	Material	Werkstoff-Nr. Material No.	DIN Bezeichnung Alt DIN Description Old	R _m /UTS (N/mm ²)	DIN Bezeichnung Neu DIN Description New	
P	Unlegierter Baustahl + Automatenstahl	Plain carbon steel + free cutting steel	1.0570	St52-3	-700	S355J2G3	
			1.1730	C45	-800	C45U	
			1.0715	9SMn28	-700	11SMn30	
				1.1191	Ck45	500-950	C45E
				1.7219	26CrMo4		26CrMo4-2
	Vergütungsstahl, mittelfest	Heat-treatment steel, medium strength	1.7225	42CrMo4	500-950	42CrMo4	
	Stahlguss	Cast steel	1.8159	51CrV4		51CrV4	
			1.0416	GS40	-950	GS40	
	Einsatzstahl	Case hardening steel	1.7131	16MnCr5	-950	16MnCr5	
	Rost- und säurebe- ständiger Stahl, ferritisch, martensitisch	Stainless steel, ferritic, martensitic	1.4006	X10Cr13	500-950	X12Cr13	
			1.4104	X12CrMoS17		X14CrMoS17	
			1.4122	X35CrMo17		X39CrMo17-1	
	Vergütungsstahl, hochfest	Heat-treatment steel, high strength	1.7225	42CrMo4	950-1400	42CrMo4	
	Nitrierstahl, vergütet	Nitriding steel, heat treated	1.6580	30CrNiMo8		30CrNiMo8	
	Werkzeugstahl	Tool steel	1.8504	34CrAl6	950-1400	34CrAl6	
1.2344			X40CrMoV5.1	-900	X40CrMoV5-1		
1.2343			X38CrMoV5 1	950-1400	X37CrMoV5-1		
1.2379			X155CrVMo12 1	-950	X153CrMoV12-1		
1.2358			60CrMoV18-5	850-1000	60CrMoV18-5		
1.2080			X210Cr12	950-1400	X210Cr12		
1.2714			55NiCrMoV7	1100-1350	55NiCrMoV7		
1.2311			40CrMnMo7	-1100	40CrMnMo7		
1.2312			40CrMnNiMoS8.6	-1150	40CrMnNiMoS8-6		
1.2316			X38CrMo16	-1100	X38CrMo16		
		1.2738	45CrMnNiMo8.6.4	950-1150	45CrMnNiMo8-6-4		
M	Rost- und säurebe- ständiger Stahl, austenitisch	Stainless steel, austenitic	1.4301	X2CrNiMo17-12-2	500-950	X5CrNiMo18-10	
			1.4404	X6CrNiMoTi17-12-2		X2CrNiMo17-12-2	
			1.4571	X10CrNiMoTi18		X10CrNiMoTi18	
Rost- und säurebe- ständiger Stahl, martensitisch aushärtbar	Stainless steel, martensitic steel	1.2709	X3NiCoMoTi18-9-5	800-1000	X3NiCoMoTi18-9-5		
		1.4542	X5CrNiCuNb16-4		X5CrNiCuNb16-4		
		1.4568	X7CrNiAl17-7		X7CrNiAl17-7		
K	Grauguss	Grey cast iron	0.6025	GG25	100-400 (120-260 HB)	EN-GJL-250	
	Legierter Grauguss	Alloyed grey cast iron	0.6678	GGL-NiCr35 2	150-250 (160-230 HB)	EN-GJLA-XNiCr35-2	
	Sphäroguss	Nodular cast iron	0.7060 0.7070	GGG60 GGG70L	400-800 (120-310 HB)	EN-GJS-600-3 EN-GJS-700-2U	
	Temperguss	Malleable cast iron	0.8155	GTS55	350-700 (150-280 HB)	EN-GJMB-550-4	
N	Aluminium-Legierungen, kurzspanend	Aluminium alloys, short chipping	3.2581	G-AlSi12	-400	G-IGK-AlSi12	
	Aluminium-Legierungen, langspanend	Aluminium alloys, long chipping	3.3535 3.4365	AlMg3 AlZnMgCu1,5	-550	AlMg3 AlZnMgCu1,5	
	Kupfer-Legierungen, kurzspanend	Copper alloys, short chipping	2.0402	MS58	-500	CuZn40Pb2	
	Kupfer-Legierungen, langspanend	Copper alloys, long chipping	2.0320 2.0975	MS63 CuAl10Ni	300-500	CuZn37 CuAl10Fe5Ni5-C	
	Thermoplaste	Thermoplastics		PVC	40-70	PVC	
	Duroplaste	Duroplastics		Bakelit, Melamin	20-40	Bakelit, Melamin	
	Graphit	Graphite					
	Zirkonoxidkeramik	Zircon oxide ceramics					
S	Titan-Legierungen, mittelfest	Titanium alloys, medium strength	3.7115 3.7164	TiAl5Sn2,5 TiAl6V4	-950	TiAl5Sn2-5 TiAl6V4	
	Titan-Legierungen, hochfest	Titanium alloys, high strength	3.7174	TiAl6Sn2	900-1400	TiAl6V6Sn2	
	Nickelbasis-Legierungen, mittelfest	Nickel based alloys, medium strength	2.4670	NiCr12Al6MoNb	-950	NiCr12Al6MoNb	
	Nickelbasis-Legierungen, hochwarmfest	Heat resistant nickel based alloys, high strength	2.4668	NiCr19Fe19NbMo	900-1400	Inconel 718 NiCr19Fe19Nb5Mo3	
	Kobalt-Chrom-Legierung	Cobalt chromium alloys					
H	Hartguss	Chilled cast iron		Ni-hard, Ampco	300-600 HB	Ni-hard, Ampco	
	Gehärteter Stahl	Hardened steel			45-52 HRC		
					53-59 HRC		
				60-65 HRC			

Die angegebenen Schnittwerte sind Startwerte und müssen auf die vorhandenen Bedingungen abgestimmt werden.

Schnittgeschwindigkeit Cutting speed v_c (m/min)		Vorschub pro Zahn Feed per tooth f_z (mm/z.)						a_e Schlichten Finishing	
		$\varnothing 6$	$\varnothing 8$	$\varnothing 10$	$\varnothing 12$	$\varnothing 16$	$\varnothing 20$		
WPB-FB LCKP10M	WPB-FB LBHK95M	a_p max f_z max	a_p max f_z max	a_p max f_z max	a_p max f_z max	a_p max f_z max	a_p max f_z max	d x 0,02	
280-300		0,10 0,12	0,15 0,15	0,15 0,18	0,20 0,20	0,25 0,35	0,30 0,40		d x 0,02
280-300		0,10 0,12	0,15 0,15	0,15 0,18	0,20 0,20	0,25 0,35	0,30 0,40		
280-300		0,10 0,12	0,15 0,15	0,15 0,18	0,20 0,20	0,25 0,35	0,30 0,40		
280-300		0,10 0,12	0,15 0,15	0,15 0,18	0,20 0,20	0,25 0,35	0,30 0,40		
280-300		0,10 0,12	0,15 0,15	0,15 0,18	0,20 0,20	0,25 0,35	0,30 0,40		
280-300		0,10 0,12	0,15 0,15	0,15 0,18	0,20 0,20	0,25 0,35	0,30 0,40		
280-300		0,10 0,12	0,15 0,15	0,15 0,18	0,20 0,20	0,25 0,35	0,30 0,40		
280-300		0,10 0,12	0,15 0,15	0,15 0,18	0,20 0,20	0,25 0,35	0,30 0,40		
220-240		0,10 0,12	0,15 0,15	0,15 0,18	0,20 0,20	0,25 0,35	0,30 0,40		
280-300		0,10 0,12	0,15 0,15	0,15 0,18	0,20 0,20	0,25 0,35	0,30 0,40		
280-320		0,10 0,12	0,15 0,15	0,15 0,18	0,20 0,20	0,25 0,35	0,30 0,40		
220-240		0,10 0,12	0,15 0,15	0,15 0,18	0,20 0,20	0,25 0,35	0,30 0,40	d x 0,02	
220-240		0,10 0,12	0,15 0,15	0,15 0,18	0,20 0,20	0,25 0,35	0,30 0,40		
240-260	600-800	0,10 0,12	0,15 0,15	0,15 0,18	0,20 0,20	0,25 0,35	0,30 0,40	d x 0,02	
280-300	400-600	0,10 0,12	0,15 0,15	0,15 0,18	0,20 0,20	0,25 0,35	0,30 0,40		
340-360	600-800	0,10 0,12	0,15 0,15	0,15 0,18	0,20 0,20	0,25 0,35	0,30 0,40		
280-300		0,10 0,12	0,15 0,15	0,15 0,18	0,20 0,20	0,25 0,35	0,30 0,40		
								d x 0,02	
								d x 0,02	
100-120		0,10 0,12	0,15 0,15	0,15 0,18	0,20 0,20	0,25 0,35	0,30 0,40		
80-100		0,10 0,12	0,15 0,15	0,15 0,18	0,20 0,20	0,25 0,35	0,30 0,40		
120-140		0,10 0,12	0,15 0,15	0,15 0,18	0,20 0,20	0,25 0,35	0,30 0,40	d x 0,02	
240-260	400	0,10 0,12	0,15 0,15	0,15 0,18	0,20 0,20	0,25 0,35	0,30 0,40		
220-240	240	0,10 0,12	0,15 0,15	0,15 0,18	0,20 0,18	0,20 0,20	0,25 0,25		
120-140	220	0,10 0,12	0,15 0,15	0,15 0,18	0,20 0,18	0,20 0,20	0,20 0,25		

The cutting data indicated are starting values and must be adjusted to the prevailing conditions.

ISO-Code	Geometrie Geometry	Durchmesser Diameter	Seite Page	Schnitt- daten Parameters	Schrup- pen Rough- ing	Vor- schlichen Semi- finishing	Schlich- ten Finish- ing	Werkstoffe Materials						Anwendung Application	
								P	M	K	N	S	H		
WPR ..-N		6–32 mm	354 (465)	356		▼▼	▼▼▼								Stahl, Stahlguss, hochwarmfeste Stähle und gehärtetem Stahl bis 60 HRC Steel, cast steel, high temperature alloys and hardened steel up to 60 HRC
WPR ..-CF		8–32 mm	355 (462)	356		▼▼									Mit Spanleitstufe für langspanende Eisenwerkstoffe With chip breaker for longchipping ferrous metals
WPR ..-D		6–32 mm	360 (463)	362		▼▼	▼▼▼								Stahl, Stahlguss, hochwarmfeste Stähle Steel, cast steel, high temperature alloys
WPR ..-DN		6–32 mm	361 (464)	364	▼	▼▼	▼▼▼								NE-Metalle, Kunststoffe, Graphit und Titan Non-ferrous materials, plastics, graphite and titanium
WPR ..-SF		8–20 mm	346 (466)	348			▼▼▼								Stahl, Stahlguss, hochwarmfeste Stähle und gehärtetem Stahl bis 65 HRC Steel, cast steel, high temperature alloys and hardened steel up to 65 HRC
WPR ..-AR		12–32 mm	350 (460)	352	▼	▼▼									Stahl, Stahlguss, hochwarmfeste Stähle Steel, cast steel, high temperature alloys
WPR ..-AS		25–32 mm	334 (461)	336	▼	▼▼									NE-Metalle und Kunststoffe (Modellbau) Non-ferrous materials and plastics (modelling)
WPB ..-N		8–25 mm	371 (457)	376		▼▼	▼▼▼								Stahl, Stahlguss, hochwarmfeste Stähle und gehärtetem Stahl bis 60 HRC Steel, cast steel, high temperature alloys and hardened steel up to 60 HRC
WPB ..-CF		6–25 mm	380 (459)	384	▼	▼▼									Mit Spanleitstufe für langspanende Eisenwerkstoffe With chip breaker for longchipping ferrous metals
WPB ..-AF		6–20 mm	370 (454)	374		▼▼	▼▼▼								Stahl, Stahlguss, hochwarmfeste Stähle und gehärtete Stähle bis 62 HRC Steel, cast steel, high temperature alloys and hardened steel up to 62 HRC
WPB ..-FB		6–20 mm	393 (455)	396		▼▼	▼▼▼								Stahl, Stahlguss, hochwarmfeste Stähle und gehärtete Stähle bis 62 HRC Steel, cast steel, high temperature alloys and hardened steel up to 62 HRC
WPB ..-HF		6–32 mm	392 (456)	394	▼										Stahl, Stahlguss, hochwarmfeste Stähle Steel, cast steel, high temperature alloys
WPV ..-N		8–32 mm	381 (469)	388		▼▼	▼▼▼								Stahl, Stahlguss, hochwarmfeste Stähle und gehärtetem Stahl bis 60 HRC Steel, cast steel, high temperature alloys and hardened steel up to 60 HRC
WPV ..-CF		8–32 mm	382 (468)	384	▼	▼▼									Mit Spanleitstufe für langspanende Eisenwerkstoffe With chip breaker for longchipping ferrous metals

Weitere Anwenderinformationen zum neuen Farbleitsystem für LMT-Kieninger Wendepetten auf Seite 314.

Further application informations regarding the new color guide system for LMT-Kieninger indexable inserts see page 314.

Seitenzahlen für das Kapitel Wendeschneidplatten sind in Klammern geschrieben.

Page numbers for the chapter indexable inserts are written in brackets.

WPR – AR

Sehr stabile Wendeplattengeometrie zum Schruppen und Semischlichten von Stahl, Stahlguss und hochwarmfesten Stählen.

Merkmal:

- Stabile Querschneide und Unterbau bis ins Schneidzentrum.

Very stable insert geometry for roughing and semi-finishing of steel, cast steel and high-temperature steels.

Feature:

- Stable cross-cut and substructure down to the center of the cutting edges

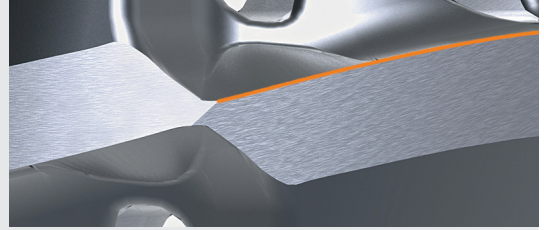

WPR – N

Universalgeometrie für die Bearbeitung von Stahl, Stahlguss und hochwarmfesten Stählen und gehärtetem Stahl bis ca. 60 HRC.

Merkmal:

- Sehr kleine Querschneide für universellen Einsatz

Universal geometry for machining steel, cast steel and high-temperature steels and hardened steel up to approx. 60 HRC.

Feature:

- Very small cross-cut for universal use

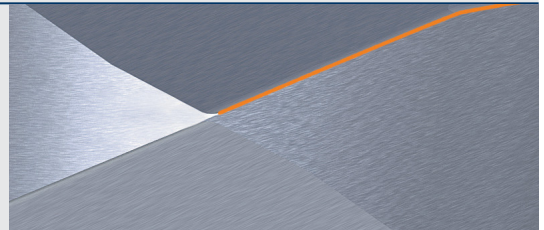

WPR – D

Schlichtgeometrie mit gedrahter Schneidkante und minimaler Querschneide für die Bearbeitung von Stahl, Stahlguss und hochwarmfesten Stählen und gehärtetem Stahl bis ca. 63 HRC.

Merkmal:

- Gedrahtete Schneidkante für weichen Schnitt

Finishing geometry with helical cutting edge and minimum cross-cut for machining steel, cast steel and high-temperature steels and hardened steel up to approx. 63 HRC.

Feature:

- Helical cutting edge for soft cutting

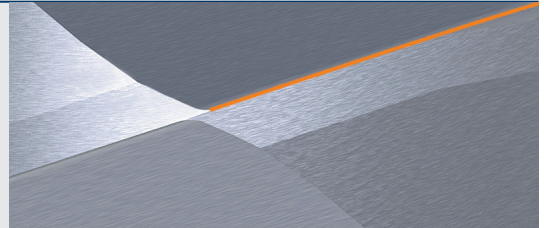

WPR – SF

Geometrie zum Feinstschlichten von Stahl, Stahlguss und hochwarmfesten Stählen und gehärtetem Stahl bis ca. 65 HRC.

Merkmal:

- Gedrahtete und polierte Schneidkante.

Geometry for very fine finishing of steel, cast steel and high-temperature steels and hardened steel up to approx. 65 HRC.

Feature:

- Helical and polished cutting edge

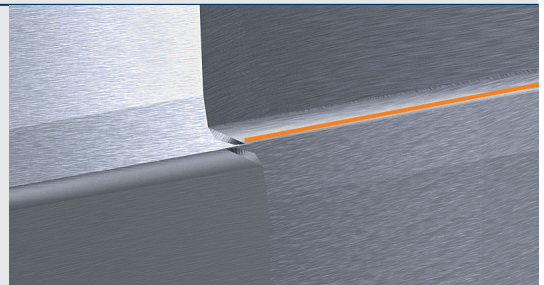

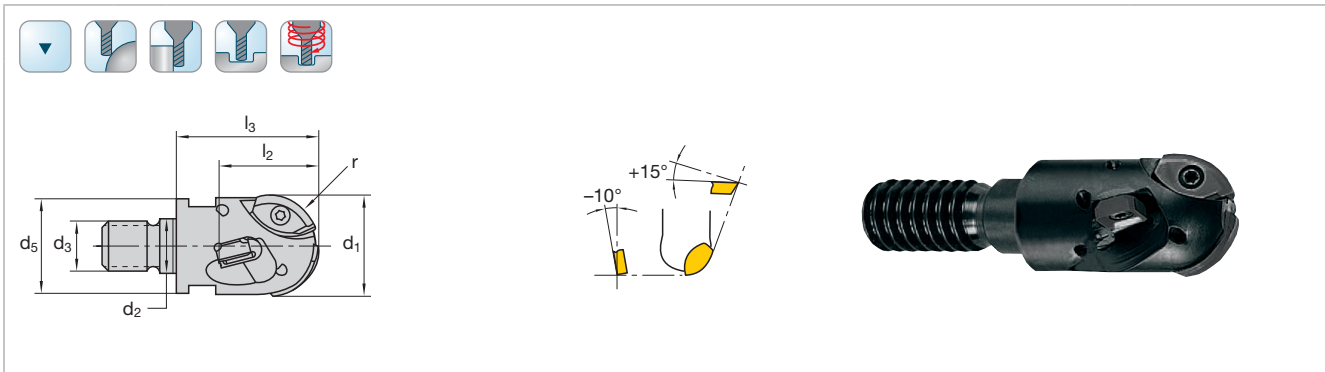

Katalog-Nr. Cat.-No.										EBT THR 11497				
d ₁	r	l ₂	l ₃	d ₃	d ₅	d ₂	z	Ident No.	LMT-Code					
20	10	20	32	M10	18	10,2	2	1041090	EBT X12.020TS032	CCMT 060204	1044972	1179-25	2237513	1048326 T8
25	12,5	24	36	M12	21	12,5	2	1041076	EBT X16.025TF036	CCMT 080308	2237513	1179-35	1045114	1048335 T15
32	16	29	45	M16	29	17	2	1041077	EBT X20.032TH045	SNKX 0904AN	1045114	1179-45	1045126	1048335 T15
40	20	37	56	M20	36	21	2	1041078	EBT X25.040TI056	SNKX 1205AN	1045123	1179-55	1045777	1048344 T20
50	25	43	56	M24	46	25	2	1041079	EBT X21.050TJ056					

Schnittwertempfehlungen ab Seite 404
 Cutting data recommendations starting page 404

Kopier-Schrupfräser – Schaftausführung
 Roughing-Copying mill – shank type

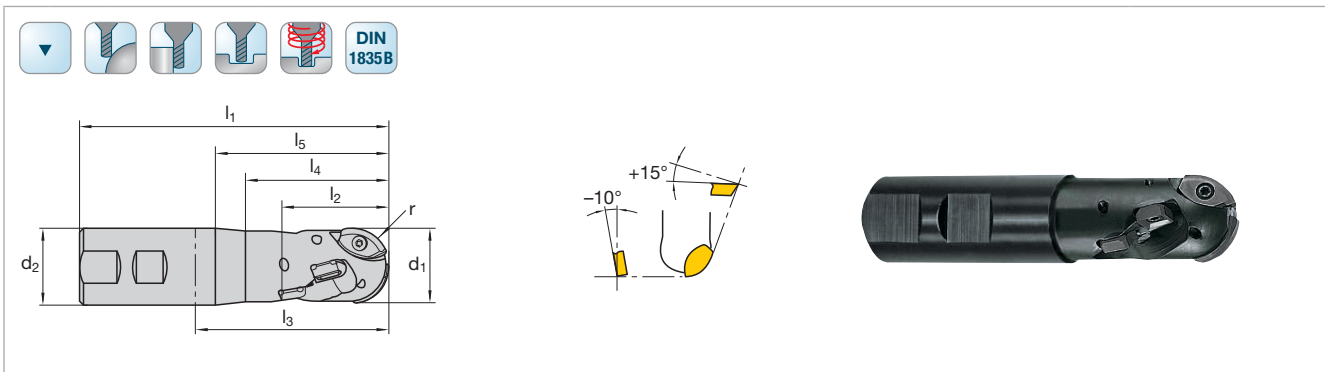

Katalog-Nr. Cat.-No.										EBT 11493					
d ₁	r	l ₂	l ₁	l ₄	l ₅	l ₃	d ₂	z	Ident No.	LMT-Code					
20	10	30	135	40	60	79	25	2	1041048	EBT X12.020BS135	CCMT060204	1044972	1179-25	2237513	1048326 T8
20	10	30	160	40	85	104	25	2	1041049	EBT X12.020BS160					
25	12,5	35	120	54	54	54	25	2	1041067	EBT X16.025BN120	CCMT080308	2237513	1179-35	1045114	1048335 T15
25	12,5	35	170	50	90	110	32	2	1041068	EBT X16.025BV170					
32	16	40	150	70	70	90	32	2	1041069	EBT X20.032BN150	SNKX0904AN	1045114	1179-45	1045126	1048335 T15
32	16	40	200	60	115	130	40	2	1041070	EBT X20.032BW200					
40	20	55	145	80	80	85	32	2	1041071	EBT X25.040BF145	SNKX1205AN	1045123	1179-55	1045777	1048344 T20
40	20	55	200	115	115	130	40	2	1041072	EBT X25.040BN200					

Schnittwertempfehlungen ab Seite 404
 Cutting data recommendations starting page 404

							Schneidstoffsorten Cutting materials										Für Fräser For cutter Cat-No.							
							Ident No.																	
N = Anzahl der Schneidkanten N = Number of cutting edges	ISO-Code	l	d	s	d ₁	b/r	LCP40M	LCPM40M	LCPK30M	LCP25M	LCPK10M	LCM45M	LCM44M	LCKP30M	LCKP10M	LCK20M		LCK10M	LCN10M	LWN10M	LCHP15M	LCH50M		
 N = 4	CCMT 060204 1196-36	6,35	6,35	2,38	2,8	0,4	1069497								1069498								ESP90	
	CCMT 080308 1196-46	7,94	7,94	3,18	3,4	0,8	1069499								1069500									
 N = 4	SNKX 0904 AN 1187-00	9,52	-	4,76	4,4	1,5	1052316								1052317								EBT	
	SNKX 1205 AN 1187-10	12,7	12,7	5,56	5,2	2	1052301		1052315						1052339									
 N = 2	1179-25	12,79	7,15	3,18	3,5	10	1069560								1069562								EBT	
	1179-35	15,99	8,94	3,97	4,1	12,5	1069563								1069564									
	1179-45	20,47	11,44	5,08	4,5	16	1069565								1069566									
	1179-55	25,58	14,3	6,35	5,5	20	1069567																	
							■	■	■	■	■	■	■	■	■	■	■	■	■	■	■	■	P	
							□	□	□	□	□	□	□	□	□	□	□	□	□	□	□	□	□	M
																								K
																								N
																								S
																								H

■ = Hauptanwendung First choice
□ = Nebenanwendung Alternative

Sortenbeschreibung/-bezeichnung und ISO-Code ab Seite 424/477
Description/Designation of grades and ISO-Code starting page 424/477

Fräsen mit Wendeschneidplatten
Milling with indexable inserts

Schnittwertempfehlungen Cutting data recommendations

	Werkstoff	Material	Werkstoff-Nr. Material No.	DIN Bezeichnung Alt DIN Description Old	R_m/UTS (N/mm²)	DIN Bezeichnung Neu DIN Description New
P	Unlegierter Baustahl + Automatenstahl	Plain carbon steel + free cutting steel	1.0570	St52-3	-700	S355J2G3
			1.1730	C45	-800	C45U
			1.0715	9SMn28	-700	11SMn30
			1.1191 1.7219	Ck45 26CrMo4	500-950	C45E 26CrMo4-2
	Vergütungsstahl, mittelfest	Heat-treatment steel, medium strength	1.7225	42CrMo4	500-950	42CrMo4
			1.8159	51CrV4		51CrV4
	Stahlguss	Cast steel	1.0416	GS40	-950	GS40
	Einsatzstahl	Case hardening steel	1.7131	16MnCr5	-950	16MnCr5
	Rost- und säurebe- ständiger Stahl, ferritisch, martensitisch	Stainless steel, ferritic, martensitic	1.4006	X10Cr13	500-950	X12Cr13
			1.4104 1.4122	X12CrMoS17 X35CrMo17		X14CrMoS17 X39CrMo17-1
			1.7225 1.6580	42CrMo4 30CrNiMo8	950-1400	42CrMo4 30CrNiMo8
	Vergütungsstahl, hochfest	Heat-treatment steel, high strength	1.7225 1.6580	42CrMo4 30CrNiMo8	950-1400	42CrMo4 30CrNiMo8
	Nitrierstahl, vergütet	Nitriding steel, heat treated	1.8504 1.2344	34CrAl6 X40CrMoV5.1	950-1400 -900	34CrAl6 X40CrMoV5-1
	Werkzeugstahl	Tool steel	1.2343	X38CrMoV5 1	950-1400	X37CrMoV5-1
1.2379			X155CrVMo12 1	-950	X153CrMoV12-1	
1.2358			60CrMoV18-5	850-1000	60CrMoV18-5	
1.2080			X210Cr12	950-1400	X210Cr12	
1.2714			55NiCrMoV7	1100-1350	55NiCrMoV7	
1.2311			40CrMnMo7	-1100	40CrMnMo7	
1.2312			40CrMnNiMoS8.6	-1150	40CrMnNiMoS8-6	
1.2316 1.2738			X38CrMo16 45CrMnNiMo8.6.4	-1100 950-1150	X38CrMo16 45CrMnNiMo8-6-4	
M	Rost- und säurebe- ständiger Stahl, austenitisch	Stainless steel, austenitic	1.4301	X2CrNiMo17-12-2	500-950	X5CrNiMo18-10
			1.4404	X6CrNiMoTi17-12-2		X2CrNiMo17-12-2
			1.4571	X10CrNiMoTi18		X10CrNiMoTi18
	Rost- und säurebe- ständiger Stahl, martensitisch aushärtbar	Stainless steel, martensitic steel	1.2709	X3NiCoMoTi18-9-5	800-1000	X3NiCoMoTi18-9-5
			1.4542 1.4568	X5CrNiCuNb16-4 X7CrNiAl17-7		X5CrNiCuNb16-4 X7CrNiAl17-7
K	Grauguss	Grey cast iron	0.6025	GG25	100-400 (120-260 HB)	EN-GJL-250
	Legierter Grauguss	Alloyed grey cast iron	0.6678	GGL-NiCr35 2	150-250 (160-230 HB)	EN-GJLA-XNiCr35-2
	Sphäroguss	Nodular cast iron	0.7060	GGG60	400-800	EN-GJS-600-3
			0.7070	GGG70L	(120-310 HB)	EN-GJS-700-2U
Temperguss	Malleable cast iron	0.8155	GTS55	350-700 (150-280 HB)	EN-GJMB-550-4	
N	Aluminium-Legierungen, kurzspanend	Aluminium alloys, short chipping	3.2581	G-AlSi12	-400	G-IGK-AlSi12
	Aluminium-Legierungen, langspanend	Aluminium alloys, long chipping	3.3535	AlMg3	-550	AlMg3
			3.4365	AlZnMgCu1,5		AlZnMgCu1,5
	Kupfer-Legierungen, kurzspanend	Copper alloys, short chipping	2.0402	MS58	-500	CuZn40Pb2
	Kupfer-Legierungen, langspanend	Copper alloys, long chipping	2.0320 2.0975	MS63 CuAl10Ni	300-500	CuZn37 CuAl10Fe5Ni5-C
	Thermoplaste	Thermoplastics		PVC	40-70	PVC
Duroplaste	Duroplastics		Bakelit, Melamin	20-40	Bakelit, Melamin	
S	Titan-Legierungen, mittelfest	Titanium alloys, medium strength	3.7115 3.7164	TiAl5Sn2,5 TiAl6V4	-950	TiAl5Sn2-5 TiAl6V4
	Titan-Legierungen, hochfest	Titanium alloys, high strength	3.7174	TiAl6Sn2	900-1400	TiAl6V6Sn2
	Nickelbasis-Legierungen, mittelfest	Nickel based alloys, medium strength	2.4670	NiCr12Al6MoNb	-950	NiCr12Al6MoNb
	Nickelbasis-Legierungen, hochwarmfest	Heat resistant nickel based alloys, high strength	2.4668	NiCr19Fe19NbMo	900-1400	Inconel 718 NiCr19Fe19Nb5Mo3
H	Hartguss	Chilled cast iron		Ni-hard, Ampco	300-600 HB	Ni-hard, Ampco

Die angegebenen Schnittwerte sind Startwerte und müssen auf die vorhandenen Bedingungen abgestimmt werden.
The cutting data indicated are starting values and must be adjusted to the prevailing conditions.

Schnittgeschwindigkeit Cutting speed v_c (m/min)			
Schruppen Roughing		Schlichten Finishing	
mit Rundplatte with round inserts	mit Schaftschrupp- oder Kugelstirnfräser with roughing end mills or ball nose cutters		
250-300	160-240	250-300	
250-300	160-220	250-300	
250-300	160-200	250-300	
250-300	160-200	250-300	
250-300	160-200	250-300	
180-220	120-150	180-220	
180-220	120-150	180-220	
180-220	120-150	180-220	
250-300 (80) ²	250-350	250 (80) ²	
200-300	200-300	250-350	
200-300	200-300	250-350	
200-300	200-300	250-350	
200-300	200-300	250-350	
200-300	200-300	250-350	
300-1000	300-1000	500-1500	
200-300	200-300	250-350	
300-1000	300-1000	500-1500	
300-1000	300-1000	500-1500	
200-300	200-300	250-350	
40-80	40-80	40-80	
40-80	40-80	40-80	
40-80	40-80	40-80	
40-80	40-80	40-80	
40-80	40-80	40-80	

Fräsen mit Wendeschneidplatten
Milling with indexable inserts

¹⁾ unbeschichtete HM-Sorte, v_c -Wert der Tabelle ist gültig für diese Sorte.
uncoated grade, value of v_c is valid for this grade

Beim Einsatz unbeschichteter Sorten Schnittgeschwindigkeit um 30% reduzieren.
When using uncoated grades reduce cutting speed by 30%.

²⁾ bei Verwendung von Kühlschmierstoffen.
when using liquid coolants.

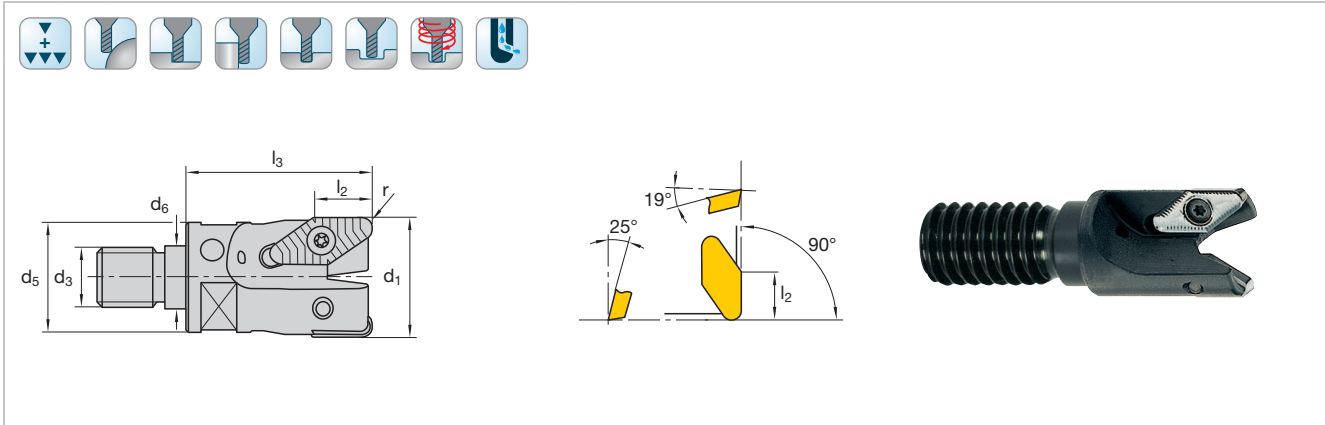

Katalog-Nr. Cat.-No.									EMZ 90 THR IK			
d ₁	r	l ₂	l ₃	d ₅	d ₃	d ₂	z	Ident No.	LMT-Code			
25	1,2	13,5	40	21	M12	12,5	2	1043247	EMZ90 V16.025TF040-I	VPGT 160412-ALM	1051312	1048335
32	3	15	50	29	M16	17	2	1043248	EMZ90 V22.032TH050-I	VCGT 220530-ALM	1045766	T15
42	3	15	50	29	M16	17	3	1043249	EMZ90 V22.042TH050-I			

Schnittwertempfehlungen ab Seite 408
Cutting data recommendations starting page 408

Fräser 90° für NE-Metalle und Kunststoffe – Schaftausführung
Mills 90° for non-ferrous metals and plastics – Shank type

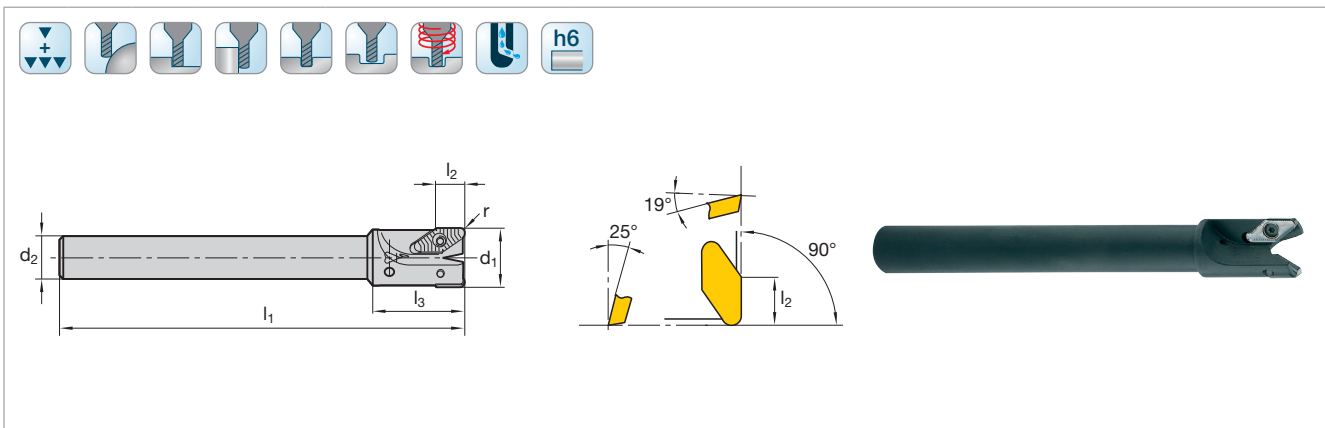

Katalog-Nr. Cat.-No.									EMZ 90 IK			
d ₁	r	l ₂	l ₁	l ₃	d ₂	z	Ident No.	LMT-Code				
25	1,2	13,5	200	40	20	2	1043243	EMZ90 V16.025AI-I	VPGT160412-ALM	1051312	1048335	
32	3	15	220	50	25	2	1043244	EMZ90 V22.032AG-I	VCGT 220530-ALM	1045766	T15	
42	3	15	220	50	25	3	1043245	EMZ90 V22.042AA-I				

Schnittwertempfehlungen ab Seite 408
Cutting data recommendations starting page 408

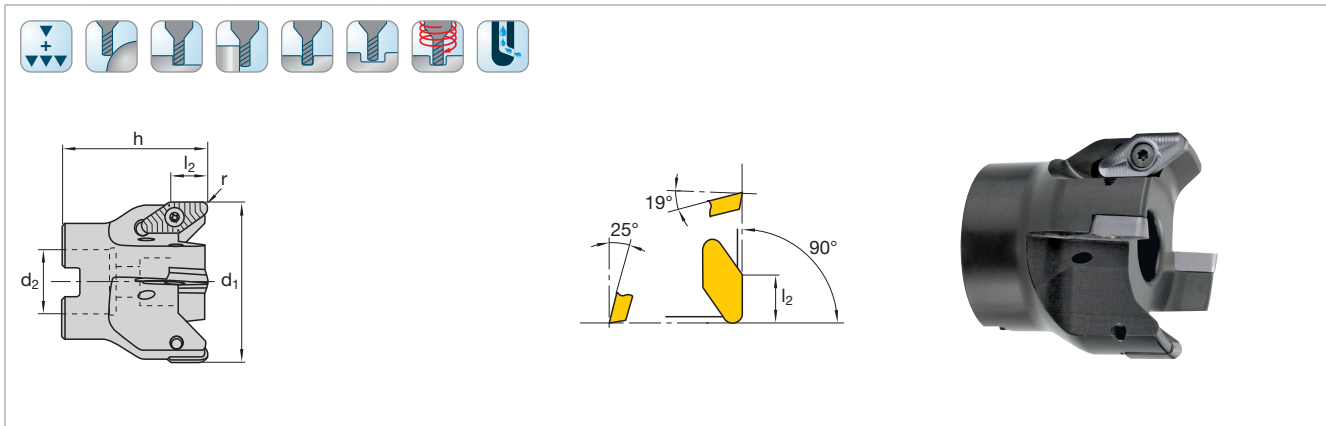

Katalog-Nr. Cat.-No.							FMZ 90 IK				
d ₁	r	l ₂	h	d ₂	z	Ident No.	LMT-Code				
42	3	15	55	16	3	1043253	FMZ90 V22.042AN-I	VCGT 220530-ALM	1045766	1048335 T15	
52	3	15	55	22	3	1043254	FMZ90 V22.052AN-I				
66	3	15	60	27	4	1043255	FMZ90 V22.066AN-I				
80	3	15	60	27	4	1043256	FMZ90 V22.080AN-I				
100	3	15	65	32	5	1043257	FMZ90 V22.100AN-I				

Fräser auch verfügbar in Zoll-Abmessungen
 Cutters also available in inch dimensions

Schnittwertempfehlungen ab Seite 408
 Cutting data recommendations starting page 408

Wendeschneidplatten für Fräskopf 90° für NE-Metalle und Kunststoffe
Indexable inserts for milling cutters 90° for non-ferrous metals and plastics

N = Anzahl der Schneidkanten N = Number of cutting edges	ISO-Code	l	d	s	d ₁	r	Schneidstoffsorten Cutting materials Ident No.											Für Fräser For cutter Cat.-No.									
							LCP40M	LCPM40M	LCPK30M	LCP25M	LCPK10M	LCM45M	LCM44M	LCKP30M	LCKP10M	LCK20M	LCK10M		LCN10M	LWN10M	LCHP15M	LCH50M					
 N = 2	VCGT 220530 ALM	22,1	12,7	5,56	5,5	3									1069760							EMZ90 FMZ90					
	VPGT 160412 ALM	16,6	12,7	4,76	4,4	1,2									1069758						1069757						
															<input type="checkbox"/>								P				
																									M		
																<input checked="" type="checkbox"/>										K	
																									<input checked="" type="checkbox"/>	N	
																										S	
																										H	

= Hauptanwendung First choice
 = Nebenanwendung Alternative
 Sortenbeschreibung/-bezeichnung und ISO-Code ab Seite 424/477
 Description/Designation of grades and ISO-Code starting page 424/477

Fräser mit Wendeschneidplatten
Milling with indexable inserts

Schnittwertempfehlungen für Fräser 90° für NE-Metalle und Kunststoffe Cutting data recommendations for mills 90° with non-ferrous metals and plastics

	Werkstoff	Material	Werkstoff-Nr. Material No.	DIN Bezeichnung Alt DIN Description Old	R _m /UTS (N/mm ²)	DIN Bezeichnung Neu DIN Description New
N	Aluminium-Legierungen, kurzspanend	Aluminium alloys, short chipping	3.2581	G-AlSi12	-400	G-IGK-AlSi12
	Aluminium-Legierungen, langspanend	Aluminium alloys, long chipping	3.3535	AlMg3	-550	AlMg3
			3.4365	AlZnMgCu1,5		AlZnMgCu1,5
	Kupfer-Legierungen, kurzspanend	Copper alloys, short chipping	2.0402	MS58	-500	CuZn40Pb2
	Kupfer-Legierungen, langspanend	Copper alloys, long chipping	2.0320	MS63	300-500	CuZn37
			2.0975	CuAl10Ni		CuAl10Fe5Ni5-C
	Thermoplaste	Thermoplastics		PVC	40-70	PVC
Duroplaste	Duroplastics		Bakelit, Melamin	20-40	Bakelit, Melamin	

Die angegebenen Schnittwerte sind Startwerte und müssen auf die vorhandenen Bedingungen abgestimmt werden.
The cutting data indicated are starting values and must be adjusted to the prevailing conditions.

Maximale Vorschübe pro Zahn Maximum feed per tooth f _z (mm/z.)		
	VPGT1604...	VCGT2205...
N	0,35	0,5
	0,3	0,4

Weitere Anwendungsempfehlungen Further application recommendations

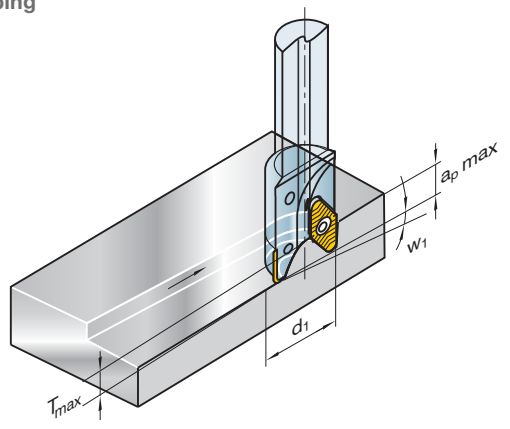
Einwärtsfräsen Ramping	Schrägungswinkel $W_{1\max}$ und innere Schnitttiefe T_{\max} Helix angle $W_{1\max}$ and internal depth of cut T_{\max}		
	VPGT 160412-ALM	VCGT 220530-ALM	
	a _{p max}	13,5	15
	T _{max}	8	9
	25	24	
	32		22
	42		15
	52		12
	66		9
	80		7
	100		5
	125		4

Schnittgeschwindigkeit Cutting speed v_c (m/min)	
LCKP10M	LWN10M
1000	800
1500–3000	1000–2000
1000–2000	800–1600
500	400
300	250
400	300
200	150

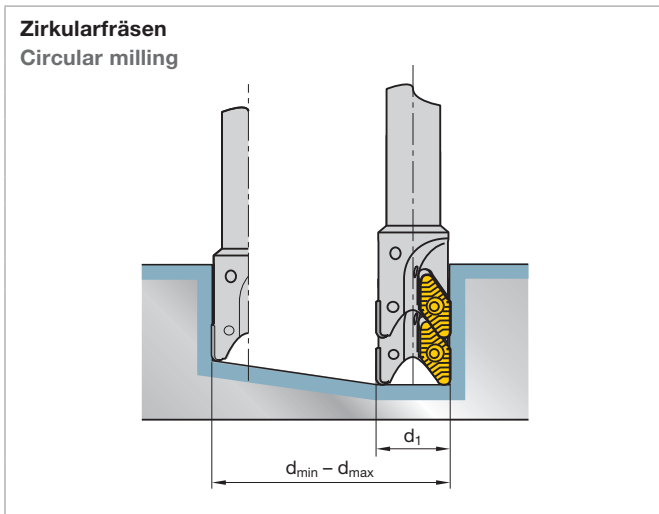

d_1 mm	d_{\min} mm	d_{\max} mm
25	35	48
32	42	58
42	62	78
52	82	98
66	110	126
80	138	154
100	178	194
125	228	244

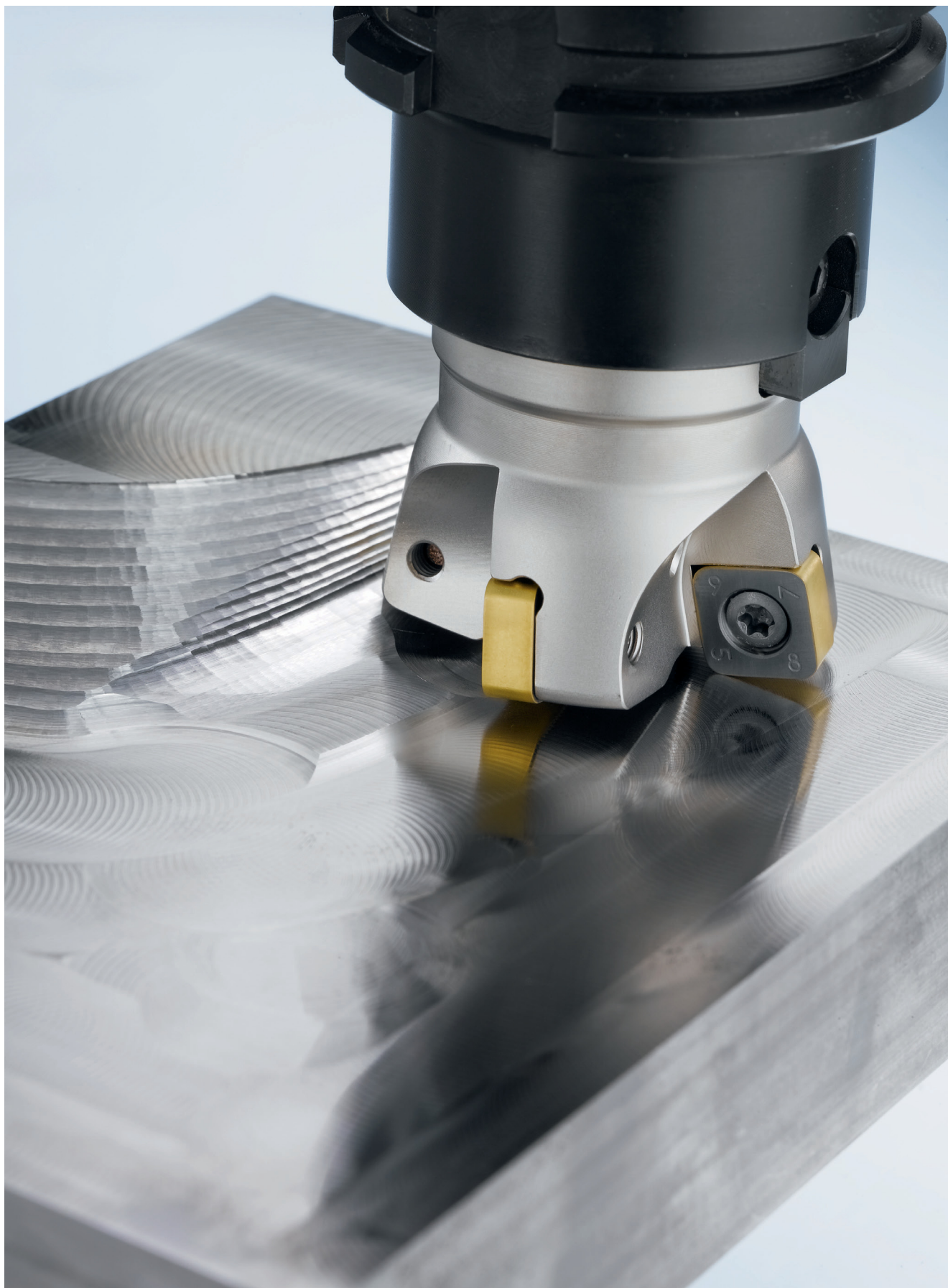

Katalog-Nr. Cat.-No.									ESP90 11403 IK				
d ₁	b ₁	T-Nuten T-slots	l ₁	l ₃	d ₃	d ₂	z	Ident No.	LMT-Code				
25	11	14	82	34	13	16	4	1069001	ESP90 C06.025BE-I	CCMT 060204 1196-36	1044972	1048326 T8	
32	13	18	90	40	15	20	4	1069003	ESP90 C08.032BB-I	CCMT 080308 1196-46	2237513		
40	17	22	108	52	19,5	25	4	1069005	ESP90 C09.040BA-I	CCMT 09T308 1196-56	1045131	1048335 T15	
50	21	28	124	64	25	32	4	1069007	ESP90 C12.050BA-I	CCMT 120408 1196-66	1045766		

Schnittwertempfehlungen ab Seite 414
Cutting data recommendations starting page 414

Wendeschneidplatten für T-Nutenfräser 90°
Indexable inserts for T-Slot cutters 90°

N = Anzahl der Schneidkanten N = Number of cutting edges	ISO-Code							Schneidstoffsorten Cutting materials										Für Fräser For cutter																																																																																																																																													
		l	d	s	d ₁	b/r	Ident No.										Cat.-No.																																																																																																																																														
 N = 2	CCMT 060204 1196-36	6,35	6,35	2,38	2,8	0,4	LCP40M 1069497	LCPM40M	LCPK30M	LCP25M	LCPK10M	LCM45M	LCM44M	LCKP30M	LCKP10M 1069498	LCK20M		LCK10M	LCN10M	LWN10M	LCHP15M	LCH50M	ESP90																																																																																																																																								
	CCMT 080308 1196-46	7,94	7,94	3,18	3,4	0,8	1069499								1069500																																																																																																																																																
	CCMT 09T308 1196-56	9,52	9,52	3,97	4,4	0,8				7075813																																																																																																																																																					
	CCMT 120408 1196-66	12,7	12,7	4,76	5,5	0,8				7077071																																																																																																																																																					
■ = Hauptanwendung First choice □ = Nebenanwendung Alternative Sortenbeschreibung/-bezeichnung und ISO-Code ab Seite 424/477 Description/Designation of grades and ISO-Code starting page 424/477																																																																																																																																																															
<table border="1" style="width:100%; text-align:center;"> <tr><td>■</td><td></td><td>■</td><td></td><td></td><td></td><td>□</td><td></td><td></td><td></td><td></td><td></td><td></td><td></td><td></td><td></td><td></td><td></td><td></td><td></td><td></td><td></td><td>P</td></tr> <tr><td>□</td><td></td><td>□</td><td></td><td></td><td></td><td></td><td></td><td></td><td></td><td></td><td></td><td></td><td></td><td></td><td></td><td></td><td></td><td></td><td></td><td></td><td></td><td>M</td></tr> <tr><td></td><td></td><td></td><td></td><td></td><td></td><td></td><td></td><td></td><td></td><td></td><td></td><td></td><td></td><td></td><td></td><td></td><td></td><td></td><td></td><td></td><td></td><td>K</td></tr> <tr><td></td><td></td><td></td><td></td><td></td><td></td><td></td><td></td><td></td><td></td><td></td><td></td><td></td><td></td><td></td><td></td><td></td><td></td><td></td><td></td><td></td><td></td><td>N</td></tr> <tr><td></td><td></td><td></td><td></td><td></td><td></td><td></td><td></td><td></td><td></td><td></td><td></td><td></td><td></td><td></td><td></td><td></td><td></td><td></td><td></td><td></td><td></td><td>S</td></tr> <tr><td></td><td></td><td></td><td></td><td></td><td></td><td></td><td></td><td></td><td></td><td></td><td></td><td></td><td></td><td></td><td></td><td></td><td></td><td></td><td></td><td></td><td></td><td>H</td></tr> </table>																						■		■				□																P	□		□																				M																							K																							N																							S																							H
■		■				□																P																																																																																																																																									
□		□																				M																																																																																																																																									
																						K																																																																																																																																									
																						N																																																																																																																																									
																						S																																																																																																																																									
																						H																																																																																																																																									

Fräsen mit Wendeschneidplatten
Milling with indexable inserts

Schnittwertempfehlungen für Schaft-, Walzenstirn-, T-Nuten- und Fasenfräser
Cutting data recommendations for end and shell end mills, T-Slot and bevel milling cutters

	Werkstoff	Material	Werkstoff-Nr. Material No.	DIN Bezeichnung Alt DIN Description Old	R_m/UTS (N/mm²)	DIN Bezeichnung Neu DIN Description New
P	Unlegierter Baustahl + Automatenstahl	Plain carbon steel + free cutting steel	1.0570	St52-3	-700	S355J2G3
			1.1730	C45	-800	C45U
			1.0715	9SMn28	-700	11SMn30
			1.1191	Ck45	500-950	C45E
			1.7219	26CrMo4		26CrMo4-2
	Vergütungsstahl, mittelfest	Heat-treatment steel, medium strength	1.7225	42CrMo4	500-950	42CrMo4
			1.8159	51CrV4		51CrV4
	Stahlguss	Cast steel	1.0416	GS40	-950	GS40
	Einsatzstahl	Case hardening steel	1.7131	16MnCr5	-950	16MnCr5
	Rost- und säurebe- ständiger Stahl, ferritisch, martensitisch	Stainless steel, ferritic, martensitic	1.4006	X10Cr13	500-950	X12Cr13
			1.4104	X12CrMoS17		X14CrMoS17
			1.4122	X35CrMo17		X39CrMo17-1
	Vergütungsstahl, hochfest	Heat-treatment steel, high strength	1.7225	42CrMo4	950-1400	42CrMo4
	1.6580	30CrNiMo8	30CrNiMo8			
	Nitrierstahl, vergütet	Nitriding steel, heat treated	1.8504	34CrAl6	950-1400	34CrAl6
			1.2344	X40CrMoV5.1	-900	X40CrMoV5-1
	Werkzeugstahl	Tool steel	1.2343	X38CrMoV5 1	950-1400	X37CrMoV5-1
1.2379			X155CrVMo12 1	-950	X153CrMoV12-1	
1.2358			60CrMoV18-5	850-1000	60CrMoV18-5	
1.2080			X210Cr12	950-1400	X210Cr12	
1.2714			55NiCrMoV7	1100-1350	55NiCrMoV7	
1.2311			40CrMnMo7	-1100	40CrMnMo7	
1.2312			40CrMnNiMoS8.6	-1150	40CrMnNiMoS8-6	
1.2316			X38CrMo16	-1100	X38CrMo16	
1.2738			45CrMnNiMo8.6.4	950-1150	45CrMnNiMo8-6-4	
M			Rost- und säurebe- ständiger Stahl, austenitisch	Stainless steel, austenitic	1.4301	X2CrNiMo17-12-2
	1.4404	X6CrNiMoTi17-12-2			X2CrNiMo17-12-2	
	1.4571	X10CrNiMoTi18			X10CrNiMoTi18	
Rost- und säurebe- ständiger Stahl, martensitisch aushärtbar	Stainless steel, martensitic steel	1.2709	X3NiCoMoTi18-9-5	800-1000	X3NiCoMoTi18-9-5	
		1.4542	X5CrNiCuNb16-4		X5CrNiCuNb16-4	
		1.4568	X7CrNiAl17-7		X7CrNiAl17-7	
K	Grauguss	Grey cast iron	0.6025	GG25	100-400 (120-260 HB)	EN-GJ1-250
	Legierter Grauguss	Alloyed grey cast iron	0.6678	GGL-NiCr35 2	150-250 (160-230 HB)	EN-GJLA-XNiCr35-2
	Sphäroguss	Nodular cast iron	0.7060	GGG60	400-800	EN-GJS-600-3
			0.7070	GGG70L	(120-310 HB)	EN-GJS-700-2U
Temperguss	Malleable cast iron	0.8155	GTS55	350-700 (150-280 HB)	EN-GJMB-550-4	
N	Aluminium-Legierungen, kurzspanend	Aluminium alloys, short chipping	3.2581	G-AISi12	-400	G-IGK-AISi12
	Aluminium-Legierungen, langspanend	Aluminium alloys, long chipping	3.3535	AlMg3	-550	AlMg3
			3.4365	AlZnMgCu1,5		AlZnMgCu1,5
	Kupfer-Legierungen, kurzspanend	Copper alloys, short chipping	2.0402	MS58	-500	CuZn40Pb2
	Kupfer-Legierungen, langspanend	Copper alloys, long chipping	2.0320	MS63	300-500	CuZn37
			2.0975	CuAl10Ni		CuAl10Fe5Ni5-C
	Thermoplaste	Thermoplastics		PVC	40-70	PVC
Duroplaste	Duroplastics		Bakelit, Melamin	20-40	Bakelit, Melamin	
Graphit	Graphite					
S	Titan-Legierungen, mittelfest	Titanium alloys, medium strength	3.7115	TiAl5Sn2,5	-950	TiAl5Sn2-5
			3.7164	TiAl6V4		Ti6AlV4
	Titan-Legierungen, hochfest	Titanium alloys, high strength	3.7174	TiAl6Sn2	900-1400	TiAl6V6Sn2
	Nickelbasis-Legierungen, mittelfest	Nickel based alloys, medium strength	2.4670	NiCr12Al6MoNb	-950	NiCr12Al6MoNb
Nickelbasis-Legierungen, hochwarmfest	Heat resistant nickel based alloys, high strength	2.4668	NiCr19Fe19NbMo	900-1400	Inconel 718 NiCr19Fe19Nb5Mo3	
H	Hartguss	Chilled cast iron		Ni-hard, Ampco	300-600 HB	Ni-hard, Ampco

1) unbeschichtete HM-Sorte, v_c-Wert der Tabelle ist gültig für diese Sorte
uncoated grade, value of v_c is valid for this grade

2) Alternativ LX610 (unbeschichtet) verwenden, dann v_c-Wert um 30% reduzieren
Use alternatively LW610 (uncoated) and reduce v_c by 30%

3) bei Verwendung von Kühlschmierstoffen
when using liquid coolants

Schnittgeschwindigkeit Cutting Speed v_c (m/min.)	Leistungsfaktor Efficiency factor $LF = \frac{\text{cm}^3}{\text{min} \cdot \text{kW}}$
160–200	24
	22
	20
140	18
130	18
130	18
140	16
120	16
120	16
120	14
240 (60) ³ 	18
160	30
110	22
90	24
100	24
300	55
1000	60
250	35
250	50
250	70
200 ⁴⁾	35
70	20
40	16
40	18
30	15
40	24

Beim Einsatz unbeschichteter Sorten Schnittgeschwindigkeit um 30% reduzieren.
When using uncoated grades reduce cutting speed by 30%.



Nassbearbeitung, auf ausreichende Emulsionszuführung achten
Wet machining, sufficient emulsion volume required

Die angegebenen Schnittwerte sind Startwerte und müssen auf die vorhandenen Bedingungen abgestimmt werden.
The cutting data indicated are starting values and must be adjusted to the prevailing conditions.

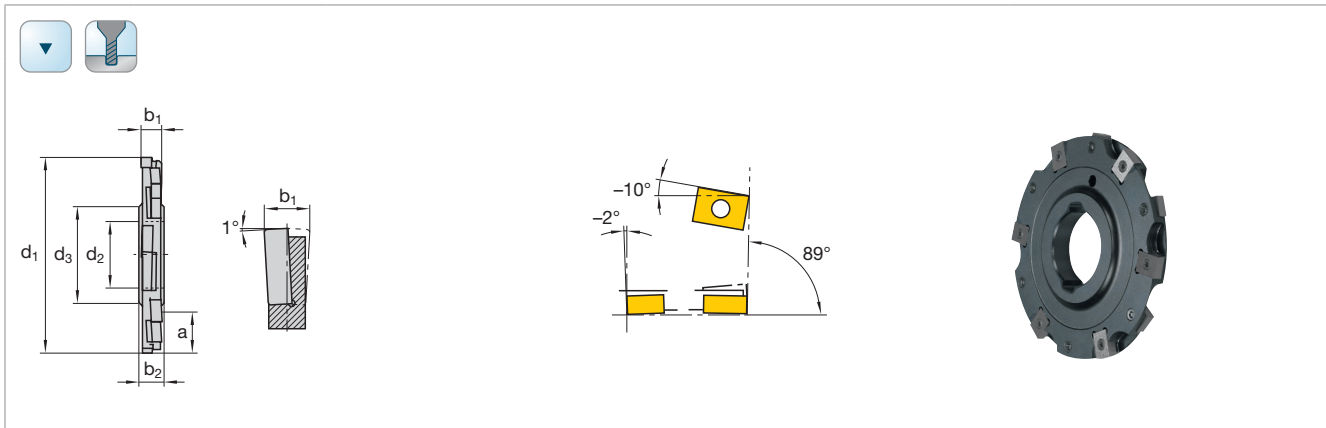

Katalog-Nr. Cat.-No.								SMN90 1103					
d ₁	b ₁	d ₃	b ₂	a	d ₂	z	Ident No.	LMT-Code					
80	5	40	8	18	27	8	1024609	SMN90 L14.080AN05	LNHX 1402 1185-55	1045819	1045793	1048433 T10	
100	5	50	8	23	32	10	1024618	SMN90 L14.100AN05					
125	5	60	8	30,5	40	12	1024627	SMN90 L14.125AN05					
80	6	40	8	18	27	8	1024636	SMN90 L14.080AN06	LNHX 1403 1185-56	1045828	1045800		
100	6	50	10	23	32	10	1024645	SMN90 L14.100AN06					
125	6	60	10	30,5	40	12	1024654	SMN90 L14.125AN06					
80	8	40	10	18	27	8	1024663	SMN90 L14.080AN08	LNHX 1404 1185-57	1051277	1045034	1048335 T15	
100	8	50	10	23	32	10	1024672	SMN90 L14.100AN08					
125	8	60	12	30,5	40	12	1024681	SMN90 L14.125AN08					
160	8	60	12	48	40	16	1024690	SMN90 L14.160AN08					
200	8	75	14	60,5	50	18	1024707	SMN90 L14.200AN08	LNHX 1405 1185-58	1045105			
80	10	40	12	18	27	8	1024716	SMN90 L14.080AN10					
100	10	50	12	23	32	10	1024725	SMN90 L14.100AN10					
125	10	60	14	30,5	40	12	1024734	SMN90 L14.125AN10					
160	10	60	14	48	40	16	1024743	SMN90 L14.160AN10					
200	10	75	16	60,5	50	18	1024752	SMN90 L14.200AN10					

Schnittwertempfehlungen ab Seite 418
Cutting data recommendations starting page 418

SMN90
Schnittwertempfehlungen
Cutting data recommendations

	Werkstoff	Material	Werkstoff-Nr. Material No.	DIN Bezeichnung Alt DIN Description Old	R_m/UTS (N/mm²)	DIN Bezeichnung Neu DIN Description New
P	Unlegierter Baustahl + Automatenstahl	Plain carbon steel + free cutting steel	1.0570	St52-3	-700	S355J2G3
			1.1730	C45	-800	C45U
			1.0715	9SMn28	-700	11SMn30
	Vergütungsstahl, mittelfest	Heat-treatment steel, medium strength	1.1191	Ck45	500-950	C45E
			1.7219	26CrMo4		26CrMo4-2
	Stahlguss	Cast steel	1.7225	42CrMo4	500-950	42CrMo4
			1.8159	51CrV4		51CrV4
	Einsatzstahl	Case hardening steel	1.0416	GS40	-950	GS40
	Rost- und säurebe- ständiger Stahl, ferritisch, martensitisch	Stainless steel, ferritic, martensitic	1.7131	16MnCr5	-950	16MnCr5
			1.4006	X10Cr13	500-950	X12Cr13
			1.4104	X12CrMoS17		X14CrMoS17
	Vergütungsstahl, hochfest	Heat-treatment steel, high strength	1.4122	X35CrMo17		X39CrMo17-1
			1.7225	42CrMo4	950-1400	42CrMo4
			1.6580	30CrNiMo8		30CrNiMo8
	Nitrierstahl, vergütet	Nitriding steel, heat treated	1.8504	34CrAl6	950-1400	34CrAl6
			1.2344	X40CrMoV5.1	-900	X40CrMoV5-1
	Werkzeugstahl	Tool steel	1.2343	X38CrMoV5 1	950-1400	X37CrMoV5-1
			1.2379	X155CrVMo12 1	-950	X153CrMoV12-1
			1.2358	60CrMoV18-5	850-1000	60CrMoV18-5
			1.2080	X210Cr12	950-1400	X210Cr12
1.2714			55NiCrMoV7	1100-1350	55NiCrMoV7	
1.2311			40CrMnMo7	-1100	40CrMnMo7	
1.2312			40CrMnNiMoS8.6	-1150	40CrMnNiMoS8-6	
1.2316			X38CrMo16	-1100	X38CrMo16	
1.2738	45CrMnNiMo8.6.4	950-1150	45CrMnNiMo8-6-4			
M	Rost- und säurebe- ständiger Stahl, austenitisch	Stainless steel, austenitic	1.4301	X2CrNiMo17-12-2	500-950	X5CrNiMo18-10
			1.4404	X6CrNiMoTi17-12-2		X2CrNiMo17-12-2
			1.4571	X10CrNiMoTi18		X10CrNiMoTi18
	Rost- und säurebe- ständiger Stahl, martensitisch aushärtbar	Stainless steel, martensitic steel	1.2709	X3NiCoMoTi18-9-5	800-1000	X3NiCoMoTi18-9-5
1.4542			X5CrNiCuNb16-4		X5CrNiCuNb16-4	
1.4568	X7CrNiAl17-7		X7CrNiAl17-7			
K	Grauguss	Grey cast iron	0.6025	GG25	100-400 (120-260 HB)	EN-GJ1-250
	Legierter Grauguss	Alloyed grey cast iron	0.6678	GGL-NiCr35 2	150-250 (160-230 HB)	EN-GJLA-XNiCr35-2
	Sphäroguss	Nodular cast iron	0.7060	GGG60	400-800	EN-GJS-600-3
			0.7070	GGG70L	(120-310 HB)	EN-GJS-700-2U
Temperguss	Malleable cast iron	0.8155	GTS55	350-700 (150-280 HB)	EN-GJMB-550-4	
S	Titan-Legierungen, mittelfest	Titanium alloys, medium strength	3.7115	TiAl5Sn2,5	-950	TiAl5Sn2-5
			3.7164	TiAl6V4		Ti6AlV4
	Titan-Legierungen, hochfest	Titanium alloys, high strength	3.7174	TiAl6Sn2	900-1400	TiAl6V6Sn2
	Nickelbasis-Legierungen, mittelfest	Nickel based alloys, medium strength	2.4670	NiCr12Al6MoNb	-950	NiCr12Al6MoNb
Nickelbasis-Legierungen, hochwarmfest	Heat resistant nickel based alloys, high strength	2.4668	NiCr19Fe19NbMo	900-1400	Inconel 718 NiCr19Fe19Nb5Mo3	
H	Hartguss	Chilled cast iron		Ni-hard, Ampco	300-600 HB	Ni-hard, Ampco

- 1) unbeschichtete HM-Sorte, v_c-Wert der Tabelle ist gültig für diese Sorte
uncoated grade, value of v_c is valid for this grade
- 2) Alternativ LW610 (unbeschichtet) verwenden, dann v_c-Wert um 30% reduzieren
Use alternatively LW610 (uncoated) and reduce v_c by 30%
- 3) bei Verwendung bei Kühlschmierstoffen
when using liquid coolants

	HM-Sorten Carbide grade	Schnittgeschwindigkeit Cutting speed v_c (m/min)	Eingriffsgröße Engagement value			
			0,30	0,20	0,10	0,05
			Vorschub pro Zahn Feed per tooth			
	LCP25M	160-200	0,25	0,30	0,40	0,60
	LCP25M	100	0,20	0,25	0,35	0,50
	LCP25M	160	0,25	0,32	0,45	0,64
	LCP25M	120	0,20	0,25	0,35	0,50
	LCP25M	100	0,20	0,25	0,35	0,50
	LCP25M	90	0,16	0,20	0,28	0,40
	LCP25M	90	0,16	0,20	0,28	0,40
	LCP25M	90	0,16	0,20	0,28	0,40
	LCP25M	200 (80) ³⁾	0,10	0,15	0,20	0,25
	LCP25M	200 (80) ³⁾	0,10	0,15	0,20	0,25
	LCP25M ²⁾	140	0,32	0,40	0,56	0,80
	LCP25M ²⁾	80	0,25	0,32	0,45	0,64
	LCP25M ²⁾	80	0,20	0,25	0,35	0,50
	LCP25M ²⁾	100	0,20	0,25	0,35	0,50
	LW610 ¹⁾	80	0,16	0,20	0,28	0,40
	LW610 ¹⁾	50	0,12	0,15	0,21	0,30
	LCP25M	60	0,16	0,20	0,28	0,40
	LCP25M	40	0,10	0,12	0,18	0,25
	LCP25M	40	0,20	0,25	0,35	0,50

Die angegebenen Schnittwerte sind Startwerte und müssen auf die vorhandenen Bedingungen abgestimmt werden.
The cutting data indicated are starting values and must be adjusted to the prevailing conditions.

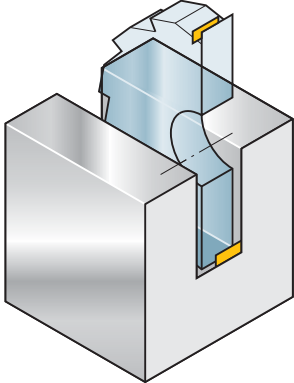
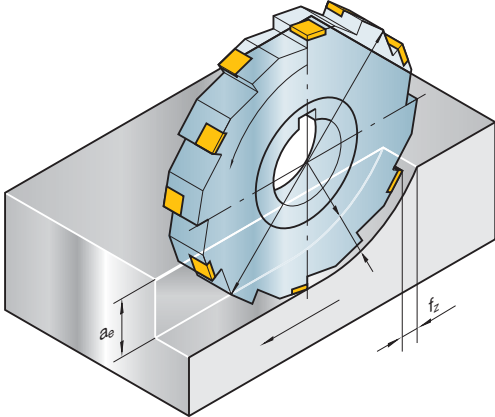
<p>Dreiseitig schneidend Three side cutting</p> 	<table border="1"> <tr> <td>Kat.-Nr. Cat.-No.</td> <td>Z_{eff}</td> </tr> <tr> <td>SMN90</td> <td>Z/2</td> </tr> </table>	Kat.-Nr. Cat.-No.	Z_{eff}	SMN90	Z/2
Kat.-Nr. Cat.-No.	Z_{eff}				
SMN90	Z/2				
	<p>Beziehung zwischen Mittenspanndicke h_m und Vorschub pro Zahn f_z Relationship between mean chip thickness h_m and feed per tooth f_z</p> $h_m = f_z \cdot \sqrt{\frac{a_e}{d_1}}$ <p>Möglichst Gleichlaufräsen Preferably climb milling</p>				

<p>Berechnungsformeln Calculating formulas</p>	
<p>Drehzahl Speed</p> $n = \frac{v_c \cdot 1000 \cdot f_1}{\pi \cdot d_1}$ <p>v_c Tab. Seite Page 419</p>	<p>Vorschubgeschwindigkeit Feed rate</p> $v_f = f_z \cdot z \cdot n$ <p>f_z Tab. Seite Page 419</p>
<p>Spanvolumen Chip volume</p> $Q = \frac{a_e \cdot a_p \cdot v_f}{1000}$ <p>f_z Tab. Seite Page 419</p>	



Fräsen mit Wendeschneibplatten
Milling with indexable inserts

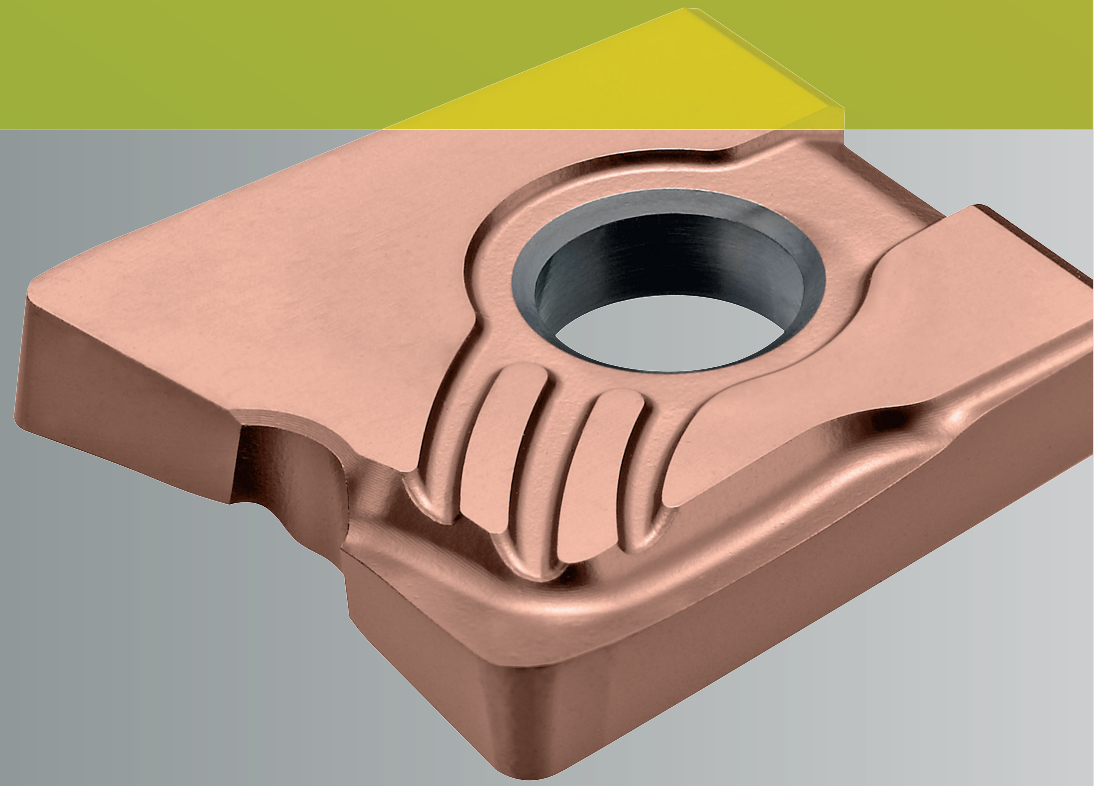

WENDE- SCHNEID- PLATTEN

INDEXABLE INSERTS

Wendeschneidplatten Indexable inserts

424 **ISO-Wendeschneidplattenbezeichnung**
ISO indexable insert designation

426 **Schneidstoffsorten**
Milling grades

Allgemeine Fräsen-Wendeschneidplatten General milling indexable inserts

428	AD...	Univex
429	AD...X	Univex Premium
431	LN...	
432	LNMU	MultiEdge T90 PRO4
432	OCKX	
433	OEKT	MultiFace P45 PRO8
434	ON...U/XNGU	MultiEdge Double8
435	RC...	
437	RD...	
438	SAKT	
438	SEKT/SEHT	MultiFace H45 PRO4
438	SE...	
439	SN...	
440	SOKX	MultiEdge 45 Double4
440	SP...	
441	TC.../VC.../VP...	
441	XCKX	
441	XCN...	MultiEdge 4Feed
442	XDM...	MultiEdge 2Feed mini
442	XNMU	MultiEdge T90 PRO8
442	XOKX	
443	XP...	MultiEdge 3Feed
443	1179-11, -21, -41	
443	1179-25, -35, -45, -55	

Gesenk- und Formbau Schneidplatten Mold and die making copy inserts

447	CMR...	CopyMax
448	CP...	FinishLine Premium
449	RD.../RN...	ACU-Jet
452	SP.../TP...	
454	WPB...	
460	WPR...	
461	WPS...	
467	WPT...	
468	WPV...	
470	WRT...	

S Grundform Insert shape	E Freiwinkel Clearance angle	K Toleranzen Tolerances	T Spanformer, Befestigung Chip breaker, clamp type	12 Schneidenlänge Cutting edge length																																																																														
A 85°		<table border="1"> <thead> <tr> <th></th> <th>m</th> <th>s</th> <th>d</th> </tr> </thead> <tbody> <tr><td>A</td><td>±0,005</td><td>±0,025</td><td>±0,025</td></tr> <tr><td>C</td><td>±0,013</td><td>±0,025</td><td>±0,025</td></tr> <tr><td>E</td><td>±0,025</td><td>±0,025</td><td>±0,025</td></tr> <tr><td>F</td><td>±0,005</td><td>±0,025</td><td>±0,013</td></tr> <tr><td>G</td><td>±0,025</td><td>±0,13</td><td>±0,025</td></tr> <tr><td>H</td><td>±0,013</td><td>±0,025</td><td>±0,013</td></tr> <tr><td>J</td><td>±0,005</td><td>±0,025</td><td>siehe see Tab. 4</td></tr> <tr><td>K</td><td>±0,013</td><td>±0,025</td><td>siehe see Tab. 4</td></tr> <tr><td>L</td><td>±0,025</td><td>±0,025</td><td>siehe see Tab. 4</td></tr> <tr><td>M</td><td>siehe see Tab. 5</td><td>±0,13</td><td>siehe see Tab. 4</td></tr> <tr><td>N</td><td>siehe see Tab. 5</td><td>±0,025</td><td>siehe see Tab. 4</td></tr> <tr><td>U</td><td>siehe see Tab. 5</td><td>±0,13</td><td>siehe see Tab. 4</td></tr> </tbody> </table>		m	s	d	A	±0,005	±0,025	±0,025	C	±0,013	±0,025	±0,025	E	±0,025	±0,025	±0,025	F	±0,005	±0,025	±0,013	G	±0,025	±0,13	±0,025	H	±0,013	±0,025	±0,013	J	±0,005	±0,025	siehe see Tab. 4	K	±0,013	±0,025	siehe see Tab. 4	L	±0,025	±0,025	siehe see Tab. 4	M	siehe see Tab. 5	±0,13	siehe see Tab. 4	N	siehe see Tab. 5	±0,025	siehe see Tab. 4	U	siehe see Tab. 5	±0,13	siehe see Tab. 4	A	<table border="1"> <thead> <tr> <th></th> <th>l</th> </tr> </thead> <tbody> <tr><td>06</td><td>6,350</td></tr> <tr><td>07</td><td>7,938</td></tr> <tr><td>09</td><td>9,525</td></tr> <tr><td>11</td><td>11,000</td></tr> <tr><td>12</td><td>12,700</td></tr> <tr><td>15</td><td>15,875</td></tr> <tr><td>16</td><td>16,500</td></tr> <tr><td>19</td><td>19,050</td></tr> <tr><td>22</td><td>22,000</td></tr> <tr><td>25</td><td>25,400</td></tr> <tr><td>31</td><td>31,750</td></tr> <tr><td>38</td><td>38,100</td></tr> </tbody> </table>		l	06	6,350	07	7,938	09	9,525	11	11,000	12	12,700	15	15,875	16	16,500	19	19,050	22	22,000	25	25,400	31	31,750	38	38,100
		m	s	d																																																																														
A		±0,005	±0,025	±0,025																																																																														
C		±0,013	±0,025	±0,025																																																																														
E		±0,025	±0,025	±0,025																																																																														
F		±0,005	±0,025	±0,013																																																																														
G		±0,025	±0,13	±0,025																																																																														
H		±0,013	±0,025	±0,013																																																																														
J		±0,005	±0,025	siehe see Tab. 4																																																																														
K		±0,013	±0,025	siehe see Tab. 4																																																																														
L	±0,025	±0,025	siehe see Tab. 4																																																																															
M	siehe see Tab. 5	±0,13	siehe see Tab. 4																																																																															
N	siehe see Tab. 5	±0,025	siehe see Tab. 4																																																																															
U	siehe see Tab. 5	±0,13	siehe see Tab. 4																																																																															
	l																																																																																	
06	6,350																																																																																	
07	7,938																																																																																	
09	9,525																																																																																	
11	11,000																																																																																	
12	12,700																																																																																	
15	15,875																																																																																	
16	16,500																																																																																	
19	19,050																																																																																	
22	22,000																																																																																	
25	25,400																																																																																	
31	31,750																																																																																	
38	38,100																																																																																	
B 82°	α_n	Tab. 4	B (70° – 90°)																																																																															
C 80°		A 3°	<table border="1"> <thead> <tr> <th colspan="2">d</th> <th>J, K, L, M</th> <th>U</th> </tr> <tr> <th>über over</th> <th>bis up to</th> <th></th> <th></th> </tr> </thead> <tbody> <tr><td>3,9</td><td>10,0</td><td>±0,05</td><td>±0,08</td></tr> <tr><td>10,0</td><td>15,0</td><td>±0,08</td><td>±0,13</td></tr> <tr><td>15,0</td><td>20,0</td><td>±0,10</td><td>±0,18</td></tr> <tr><td>20,0</td><td>26,0</td><td>±0,13</td><td>±0,25</td></tr> <tr><td>26,0</td><td>32,0</td><td>±0,15</td><td>±0,25</td></tr> </tbody> </table>	d		J, K, L, M	U	über over	bis up to			3,9	10,0	±0,05	±0,08	10,0	15,0	±0,08	±0,13	15,0	20,0	±0,10	±0,18	20,0	26,0	±0,13	±0,25	26,0	32,0	±0,15	±0,25	C (70° – 90°)																																																		
d			J, K, L, M	U																																																																														
über over			bis up to																																																																															
3,9			10,0	±0,05	±0,08																																																																													
10,0			15,0	±0,08	±0,13																																																																													
15,0			20,0	±0,10	±0,18																																																																													
20,0			26,0	±0,13	±0,25																																																																													
26,0			32,0	±0,15	±0,25																																																																													
D 55°			B 5°	Tab. 5	F																																																																													
E 75°	C 7°			<table border="1"> <thead> <tr> <th colspan="2">d</th> <th>M, N</th> <th>m</th> <th>U</th> </tr> <tr> <th>über over</th> <th>bis up to</th> <th></th> <th></th> <th></th> </tr> </thead> <tbody> <tr><td>3,9</td><td>10,0</td><td>±0,08</td><td></td><td>±0,13</td></tr> <tr><td>10,0</td><td>15,0</td><td>±0,13</td><td></td><td>±0,20</td></tr> <tr><td>15,0</td><td>20,0</td><td>±0,15</td><td></td><td>±0,27</td></tr> <tr><td>20,0</td><td>26,0</td><td>±0,18</td><td></td><td>±0,38</td></tr> <tr><td>26,0</td><td>32,0</td><td>±0,20</td><td></td><td>±0,38</td></tr> </tbody> </table>	d		M, N	m	U	über over	bis up to				3,9	10,0	±0,08		±0,13	10,0	15,0	±0,13		±0,20	15,0	20,0	±0,15		±0,27	20,0	26,0	±0,18		±0,38	26,0	32,0	±0,20		±0,38	G																																										
d		M, N		m	U																																																																													
über over		bis up to																																																																																
3,9		10,0		±0,08		±0,13																																																																												
10,0		15,0		±0,13		±0,20																																																																												
15,0		20,0		±0,15		±0,27																																																																												
20,0		26,0		±0,18		±0,38																																																																												
26,0		32,0		±0,20		±0,38																																																																												
H 120°		D 15°			H (70° – 90°)																																																																													
K 55°			E 20°	Eckenrundung, ungerade Seitenzahl Corner rounding uneven number of sides	J (70° – 90°)																																																																													
L 90°	E 20°				M																																																																													
M 86°				F 25°	Eckenrundung, gerade Seitenzahl Corner rounding, even number of sides	N																																																																												
O 135°					G 30°		Q (40° – 60°)																																																																											
P 108°						N 0°	Fasenplatten Chamfered inserts	R																																																																										
R -							P 11°		T (40° – 60°)																																																																									
S 90°								O		U (40° – 60°)																																																																								
T 60°									X Normalfrei- winkel, die eine besondere Beschreibung erfordern. Normal clearance angles, which require a special description.		W (40° – 60°)																																																																							
V 35°										Der Eckenwin- kel ist bei un- gleichwinkligen Grundformen immer der klei- nere Winkel. The corner an- gle is in the case of not equiangu- lar basic forms always the smaller angle.																																																																								
W 80°		X mit Besonderheit nach Zeichnung with special feature acc. to drawing																																																																																

() Kegelwinkel für Schraube Cone angle for screw

04 Dicke Thickness	
	S
02	2,38
03	3,18
T3	3,97
04	4,76
05	5,56
06	6,35
07	7,94
08	8,00
09	9,52

AF Schneidenecke Cutting edge corner	
Für Radiusplatten For radius inserts	
	Eckradius-r Corner radius-r
00	scharfkantig sharp-edged
02	0,2
04	0,4
08	0,8
12	1,2
16	1,6
20	2,0
	usw. etc.
Für Fasenplatten Planschneiden For chamfered insert face milling	
	Einstellwinkel Setting angle
	χ_r
A	45°
D	60°
E	75°
F	85°
P	90°
Z	Sonder Special
	Frei \sphericalangle der Planschneide Clearance \sphericalangle of face milling edge α_n
A	3°
B	5°
C	7°
D	15°
E	20°
F	25°
G	30°
N	0°
P	11°
Z	Sonder Special
MO	Rundwende- platte metrisch Round insert metric
OO	Rundwende- platte Zoll Round insert Inch

S Schneidenausführung ¹⁾ Cutting edge type ¹⁾	
	scharfkantig sharp-edged
	gerundet rounded
	gefast chamfered
	gefast und gerundet chamfered and rounded
	doppelgefast double chamfered
	doppelgefast und gerundet double chamfered and rounded

N Schneidrichtung ¹⁾ Direction of cut ¹⁾	
R	
	nur rechtsschneidend RH cut only
L	
	nur linksschneidend LH cut only
N	
	rechts- und links- schneidend RH and LH cut
¹⁾ Die Anwendung dieser Kennbuch- staben ist freigestellt. The use of these reference letters is left open.	

- BM LMT-Norm LMT-Standard	
TR	Spanflächentopographie Geometry
CF	Spanformer Chip breaker
T	breite Schneidkantenfase bevelled cutting edge
TT	Extra stabile Schruppgeometrie Heavy duty roughing geometry
ALC	Geometrie für ISO-N Geometry for nonferrous metals
ALM	Al-Geometrie, Formenbau Al geometry die and mould
BM	Geometrie für ISO-M Geometry for stainless steel
BMS	Geometrie für ISO-S und ISO-M Geometry for superalloys

Beispiel:

S	E	K	T	12	04	AF	S	N-BM	
# 1	2	3	4	5	6	7	8	9	10
1	Grundform		quadratisch						
2	Freiwinkel		20°						
3	Toleranzen		m ± 0,013 s ± 0,025 d ± 0,13						
4	Befestigung Spanfläche								
5	Schneidenlänge		12,7						
6	Dicke		4,76						
7	Schneidenecke		45° / 25°						
8	Schneidkante		gefast und gerundet						
9	Schneidrichtung		rechts- und linksschneidend						
10	Interne Bezeichnung		Geometrie für ISO-M						

Example:

1	Basic form		square						
2	Clearance angle		20°						
3	Tolerances		m ± 0.013 s ± 0.025 d ± 0.13						
4	Fixing Cutting face								
5	Length of cutting edge		12.7						
6	Thickness		4.76						
7	Cutting edge corner		45° / 25°						
8	Cutting edge		chamfered and rounded						
9	Direction of cut		right- and lefthand						
10	Internal designation		Geometry for stainless steel						

¹⁾ Abmessungen in mm
Dimensions in mm

Wendeschneidplatten-Bezeichnung ISO 1832.2 DIN 4987
Indexable insert designation

Sorte Grade	Sorte (alt) Grade (old)	Anwendungsbereich Application range										Werkstoffgruppe Material group						
		01	05	10	15	20	25	30	35	40	45	50	P	M	K	N	S	H
		Stahl Steel	Rostfrei Stainless	Grauguss Grey cast iron	NE-Metalle (Al, etc.) Nonferrous metals	Hochwärmest High temperature materials	Harte Werkstoffe Hard materials											
LCP40M	LC240T (N, Q)											■						
													□					
																	□	
LCPM40M	LC280QN											■						
LCP35M												■						
LCPK30M	LC630Q											■						
LCPK10M	LC610Q											■						
LCP25M	LC225T											■						
LCM45M	LC440T											■						
LCM44M												■						
LCMS35M													■					
LCMS30M													■					
																□		
																	■	
LCMS20M													■					
																	■	
LCKP30M	LC630T											■						
LCKP28M	LC228E											■						
													□					
																	■	
LCKP25M												□						
																	■	
LCK20M																	■	
LCKP20M												■						
LCK15M	LC615E																■	
LCK10M																	■	

Anwendungs-
schwerpunkt
Application
peak

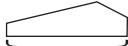

Gesamtbereich nach ISO 513
Full range to ISO 513

■ Hauptanwendung
Main application
□ Weitere Anwendung
Further applications

Sorte Grade	Sorte (alt) Grade (old)	Anwendungsbereich Application range										Werkstoffgruppe Material group						
		01	05	10	15	20	25	30	35	40	45	50	P	M	K	N	S	H
												Stahl Steel	Rostfrei Stainless	Grauguss Grey cast iron	NE-Metalle (Al, etc.) Nonferrous metals	Hochtemperatur High temperature materials	Harde Werkstoffe Hard materials	
LCKP10M	LC610Z(T)											■						
														■				
																	□	
LCN15M															■ ¹⁾			
LCN10M	LC610A														■ ¹⁾			
LCH33M	LC730Z											□						
														□				
																	■	
LCHK30M	LC630Z															■		
LCHP15M												□						
																	■	
LCHK10M	LC610Z													■				
																	■	
LCHO5M	LC603Z																■	
LWP40M	LW240											■						
LWNS33M	LW730																	
LWNS30M	LW630														■			
LWNP30M															■			
LWN10M	LW610														■			
																□		
-	LW225											■						

Anwendungs-
schwerpunkt
Application
peak



Gesamtbereich nach ISO 513
Full range to ISO 513

■ Hauptanwendung
Main application
□ Weitere Anwendung
Further applications

N = Anzahl der Schneidkanten N = Number of cutting edges	LMT-Code	l	d	s	d ₁	r	Schneidstoffsorten Cutting materials Ident No.										Für Fräser For cutter Cat-No.					
							LCP40M	LCPM40M	LCPK30M	LCP25M	LCPK10M	LCM45M	LCM44M	LCKP30M	LCKP10M	LCK20M		LCK10M	LCN10M	LWN10M	LCHP15M	LCH05M
 N = 2	ADKX 060202 SR	6,35	4,76	2,38	2	0,2	1069020													EMU90 IK		
	ADKX 060204 SR	6,35	4,76	2,38	2	0,4	1069030															
 N = 2	ADKX 090304 SR-TR	9,52	5,56	3,18	2,8	0,4	1069050													EMU90 IK ERU90		
	ADKX 090308 SR-TR	9,52	5,56	3,18	2,8	0,8	1069055															
	ADKX 090312 SR-TR	9,52	5,56	3,18	2,8	1,2	1069060															
	ADKX 090316 SR-TR	9,52	5,56	3,18	2,8	1,6	1069065															
 N = 2	ADKX 120404 SR-TR	12,7	7,4	4,76	3,4	0,4	7219155													EMU90 IK ERU90 FMU90 IK FRU90		
	ADKX 120408 SR-TR	12,7	7,4	4,76	3,4	0,8	1069070															
	ADKX 120412 SR-TR	12,7	7,4	4,76	3,4	1,2	1069075															
	ADKX 120416 SR-TR	12,7	7,4	4,76	3,4	1,6	1069080															
	ADKX 120420 SR-TR	12,7	7,4	4,76	3,4	2	1069085															
	ADKX 120440 SR-TR	12,7	7,4	4,76	3,4	4 ¹⁾	7017226															

■ = Hauptanwendung First choice
□ = Nebenanwendung Alternative

Sortenbeschreibung/-bezeichnung und ISO-Code ab Seite 424/477
Description/Designation of grades and ISO-Code starting page 424/477

¹⁾ ab Eckenradius r > 2 ist der Körper nachzuarbeiten.
from corner radius r > 2, subsequent machining must be carried out on the plate in the corner area.

■																				P
□																				M
																				K
																				N
																				S
																				H

							Schneidstoffsorten Cutting materials										Für Fräser For cutter Cat-No.								
							Ident No.																		
N = Anzahl der Schneidkanten N = Number of cutting edges	LMT-Code	l	d	s	d ₁	r	LCP40M	LCPM40M	LCPK30M	LCP25M	LCPK10M	LCM45M	LCM44M	LCKP30M	LCKP10M	LCK20M		LCK10M	LCN10M	LWN10M	LCHP15M	LCH05M			
 N = 2	ADKX 170508 SR-TR	17,5	9,62	5,6	3,8	0,8	2412980							2413978	2414004		7048197							EMU90 IK FMU90 IK FRU90	
	ADKX 170512 SR-TR	17,5	9,62	5,6	3,8	1,2	2412982					7054293	7054294	2413980	2414005		7048198								
	ADKX 170516 SR-TR	17,5	9,62	5,6	3,8	1,6	2412984					7054295	7054296	2413982	2414006		7048199								
	ADKX 170520 SR-TR	17,5	9,62	5,6	3,8	2	2412986					7054297	7054298	2413984	2414007		7048200								
	ADKX 170532 SR-TR	17,5	9,62	5,6	3,8	3,2 ¹⁾						7054299	7054300	2413228											
 N = 4	LNHU 150508 EN	15,87	9,52	5,56	4,4	0,8								1063121											
 N = 4	LNHX 1402 1185-50	14,29	11,11	2,8	4,5	0,25								1061285										SMN90	
	LNHX 1403 1185-51	14,29	11,11	3,3	4,5	0,3								1061286											
	LNHX 1404 1185-52	14,29	11,11	4,3	4,5	0,4								1061287											
	LNHX 1405 1185-53	14,29	11,11	5,3	4,5	0,5								1061288											

■ = Hauptanwendung First choice
□ = Nebenanwendung Alternative

Sortenbeschreibung/-bezeichnung und ISO-Code ab Seite 424/477
Description/Designation of grades and ISO-Code starting page 424/477

¹⁾ ab Eckenradius r > 2 ist der Körper nachzuarbeiten.
from corner radius r > 2, subsequent machining must be carried out on the plate in the corner area.

■				□	□	□	□																	P
□					■	■																		M
														■	■		■							K
																								N
																								S
																								H

							Schneidstoffsorten Cutting materials Ident No.											Für Fräser For cutter Cat-No.												
N = Anzahl der Schneidkanten N = Number of cutting edges	LMT-Code	l	d	s	d ₁	r	LCP40M	LCPM40M	LCPK30M	LCP25M	LCPK10M	LCM45M	LCM44M	LCKP30M	LCKP10M	LCK20M	LCK10M		LCN10M	LWN10M	LCHP15M	LCH05M								
 N = 4	LNHX 1402 1185-55	14,29	11,11	2,8	4,5	0,25				1061297					1061374									SMN90						
	LNHX 1403 1185-56	14,29	11,11	3,3	4,5	0,3				1061290																				
	LNHX 1404 1185-57	14,29	11,11	4,3	4,5	0,4				1061291																				
	LNHX 1405 1185-58	14,29	11,11	5,3	4,5	0,5				1061292																				
 N = 4	LNMU 130608SR	13,5	12,4	6	4,4	0,8	7167537							7167538		7189147									FMP90T L					
 N = 8	OCKX 0505 AD-TR	12	12	5,56	4,4	0,5	1054050	7002759			7002761				1054055		7047992								FCT45					
	OCKX 0606 AD-TR	16	16	6,35	5,8	0,5	1054003	7002774		7002770	7002781				1054005		7047993													
	OCKX 0606 AD-TRT	16	16	6,35	5,8	0,5		7002782							1054011		7047994													
■ = Hauptanwendung First choice □ = Nebenanwendung Alternative Sortenbeschreibung/-bezeichnung und ISO-Code ab Seite 424/477 Description/Designation of grades and ISO-Code starting page 424/477							■	■	■	■	■	■	■	■	■	■	■	■	■	■	■	■	■	■	■	■	■	■	■	P
							□	□	□	□	□	□	□	□	□	□	□	□	□	□	□	□	□	□	□	□	M			
																												K		
																												N		
																												S		
																												H		

N = Anzahl der Schneidkanten N = Number of cutting edges	LMT-Code	l	d	s	d ₁	b	Schneidstoffsorten Cutting materials Ident No.											Für Fräser For cutter Cat.-No.								
							LCP40M	LCPM40M	LCPK30M	LCP25M	LCPK10M	LCM45M	LCM44M	LCKP30M	LCKP10M	LCK20M	LCK10M		LCN10M	LWN10M	LCHP15M	LCH05M				
 N = 16	ONGU 0505 ANEN	-	12,7	5,56	4,4	2	1054009			1054017					1054014		7048392							FMN45 IK		
	ONGU 0606 ANEN	-	16	6,35	6,3	2	1054008		1054015						1054013		7048393									
	ONGU 0807 ANEN	-	20	6,85	6,3	2	7114154 ²⁾																			
 N = 16	ONMU 0606 ANSN	-	16	6,35	6,3	2	7114151 ²⁾								7114150										FMN45 IK	
	ONMU 0807 ANSN	-	20	6,8	6,3	2	7114157 ²⁾								7114156								7114155			
 N = 16	ONMW 0605 ANSN	-	16	5,56	6,3	2									7114153								7114152			FMN45 IK
	ONMW 0806 ANSN	-	20	6,35	6,3	2									7114159								7114158			
 N = 8	ONGU 0505 ANEN-SL	-	12,7	5,56	4,4	2									1054018 ¹⁾											FMN45 IK
	ONGU 0606 ANEN-SL	-	16	6,35	6,3	2									1054016 ¹⁾											
	XNGU 0808 AN+ Wiper	-	20	3,5	6,3	2									7114160											

■ = Hauptanwendung First choice
□ = Nebenanwendung Second choice

Sortenbeschreibung/-bezeichnung und ISO-Code ab Seite 424/477
Description/Designation of grades and ISO-Code starting page 424/477

1) LC610T plus TiN-Decklage
LC610T plus TiN top layer

2) Nanomold Gold
Nanomold Gold

■		■				□																			P	
□		□																								M
															■		■									K
																										N
																										S
																										H

		Schneidstoffsorten Cutting materials											Für Fräser For cutter										
		Ident No.											Cat-No.										
N = Anzahl der Schneidkanten N = Number of cutting edges	LMT-Code	l	d	s	d ₁	b	LCP40M	LCPM40M	LCPK30M	LCP25M	LCPK10M	LCM45M	LCM44M	LCKP30M	LCKP10M	LCK20M	LCK10M	LCN10M	LWN10M	LCHP15M	LCH05M		
 N = abhängig von der Einstelltiefe depending on depth of positioning	RCHX 05T1 MO 1195-02	-	5	1,98	2,1	-	1055635								1055626								ECT
	RCHX 0702 MO 1195-07	-	7	2,78	2,8	-	1068443															1055751 ¹⁾	
	RCHX 0803 MO 1195-03	-	8	3,18	3,4	-	1068387								1068391								
	RCHX 10T3 MO 1195-04	-	10	3,97	4,4	-	1068393								1068395							1055753 ¹⁾	ECT FCT
	RCHX 1205 MO 1195-13	-	12	5,56	5,2	-	1068375								1068377							1055754 ¹⁾	
	RCHX 1606 MO 1195-14	-	16	6,35	5,8	-	1068379								1068383							1055755 ¹⁾	FCT MCT
 N = abhängig von der Einstelltiefe depending on depth of positioning	RCHX 1205 MO-TR 1195-13 TR	-	12	5,56	5,2	-	1069519							1069520									ECT FCT
	RCHX 1606 MO-TR 1195-14 TR	-	16	6,35	5,8	-	1069506		1069501														FCT MCT

■ = Hauptanwendung First choice
□ = Nebenanwendung Alternative

Sortenbeschreibung/-bezeichnung und ISO-Code ab Seite 424/477
Description/Designation of grades and ISO-Code starting page 424/477

■	■	□																					P
□	□																						M
															■								K
																							N
																							S
																						■	H

							Schneidstoffsorten Cutting materials												Für Fräser For cutter																																																																																																																								
							Ident No.												Cat-No.																																																																																																																								
N = Anzahl der Schneidkanten N = Number of cutting edges	LMT-Code	l	d	s	d ₁	r	LCP40M	LCPM40M	LCPK30M	LCP25M	LCPK10M	LCM45M	LCM44M	LCKP30M	LCKP10M	LCK20M	LCK10M	LCN10M	LWN10M	LCHP15M	LCH05M																																																																																																																						
	RCKX 1205 MO-TR	-	12	5,56	4,4	-	1068470	7002749			7002758				1068475		7047995						FCT45																																																																																																																				
	RCKX 1606 MO-TR	-	16	6,35	5,8	-	1068433	7002762		7002764	7002763				1068435		7047996																																																																																																																										
	RCKX 1606 MO-TRT	-	16	6,35	5,8	-		7002767		7002768					1068464		7047997																																																																																																																										
	RCKX 1606 MO-TT	-	16	6,35	5,8	-		1055730																																																																																																																																			
<p>N = 8</p> <p>N = abhängig von der Einstelltiefe depending on depth of positioning</p>	RDHX 0501 MO 1195-01	-	5	1,5	2	-	1055505								1055639								1055756 ¹⁾	ECZ																																																																																																																			
	RDHX 0702 MO 1195-09	-	7	2,38	2,7	-	1055617								1055619								1055757 ¹⁾																																																																																																																				
	RDHW 0802 MO 1195-15	-	8	2,38	2,8	-	1068612								1068621								1055758 ¹⁾																																																																																																																				
	RDHW 1003 MO 1195-25	-	10	3,18	3,8	-	1068613								1068623					1070132			1055759 ¹⁾																																																																																																																				
	RDHW 12T3 MO 1195-35	-	12	3,97	5	-	1068614								1068625					1070142			1055760 ¹⁾	ECC ECZ FCZ																																																																																																																			
	RDHX 12T3 MO 1195-36	-	12	3,97	3,8	-	1070159								1070160								1055761 ¹⁾																																																																																																																				
	RDHW 1604 MO 1195-45	-	16	4,76	5,2	-	1068616								1068627					1070162			1055762 ¹⁾																																																																																																																				
							<table border="1"> <tr> <td>■</td><td>■</td><td>■</td><td>□</td><td>□</td><td>□</td><td>□</td><td>□</td><td>□</td><td>□</td><td>□</td><td>□</td><td>□</td><td>□</td><td>□</td><td>□</td><td>□</td><td>□</td><td>□</td><td>□</td><td>□</td><td>□</td><td>□</td><td>■</td> </tr> <tr> <td>■</td><td>■</td><td>■</td><td>□</td><td>□</td><td>□</td><td>□</td><td>□</td><td>□</td><td>□</td><td>□</td><td>□</td><td>□</td><td>□</td><td>□</td><td>□</td><td>□</td><td>□</td><td>□</td><td>□</td><td>□</td><td>□</td><td>□</td><td>■</td> </tr> <tr> <td>■</td><td>■</td><td>■</td><td>□</td><td>□</td><td>□</td><td>□</td><td>□</td><td>□</td><td>□</td><td>□</td><td>□</td><td>□</td><td>□</td><td>□</td><td>□</td><td>□</td><td>□</td><td>□</td><td>□</td><td>□</td><td>□</td><td>□</td><td>■</td> </tr> <tr> <td>■</td><td>■</td><td>■</td><td>□</td><td>□</td><td>□</td><td>□</td><td>□</td><td>□</td><td>□</td><td>□</td><td>□</td><td>□</td><td>□</td><td>□</td><td>□</td><td>□</td><td>□</td><td>□</td><td>□</td><td>□</td><td>□</td><td>□</td><td>■</td> </tr> <tr> <td>■</td><td>■</td><td>■</td><td>□</td><td>□</td><td>□</td><td>□</td><td>□</td><td>□</td><td>□</td><td>□</td><td>□</td><td>□</td><td>□</td><td>□</td><td>□</td><td>□</td><td>□</td><td>□</td><td>□</td><td>□</td><td>□</td><td>□</td><td>■</td> </tr> </table>												■	■	■	□	□	□	□	□	□	□	□	□	□	□	□	□	□	□	□	□	□	□	□	■	■	■	■	□	□	□	□	□	□	□	□	□	□	□	□	□	□	□	□	□	□	□	□	■	■	■	■	□	□	□	□	□	□	□	□	□	□	□	□	□	□	□	□	□	□	□	□	■	■	■	■	□	□	□	□	□	□	□	□	□	□	□	□	□	□	□	□	□	□	□	□	■	■	■	■	□	□	□	□	□	□	□	□	□	□	□	□	□	□	□	□	□	□	□	□	■	
■	■	■	□	□	□	□	□	□	□	□	□	□	□	□	□	□	□	□	□	□	□	□	■																																																																																																																				
■	■	■	□	□	□	□	□	□	□	□	□	□	□	□	□	□	□	□	□	□	□	□	■																																																																																																																				
■	■	■	□	□	□	□	□	□	□	□	□	□	□	□	□	□	□	□	□	□	□	□	■																																																																																																																				
■	■	■	□	□	□	□	□	□	□	□	□	□	□	□	□	□	□	□	□	□	□	□	■																																																																																																																				
■	■	■	□	□	□	□	□	□	□	□	□	□	□	□	□	□	□	□	□	□	□	□	■																																																																																																																				

■ = Hauptanwendung First choice
□ = Nebenanwendung Second choice
Sortenbeschreibung/-bezeichnung und ISO-Code ab Seite 424/477
Description/Designation of grades and ISO-Code starting page 424/477
1) Schneidkantenführung Typ G
Cutting edge design type G

Wendeschneidplatten
Indexable inserts

		Schneidstoffsorten Cutting materials Ident No.											Für Fräser For cutter Cat-No.											
N = Anzahl der Schneidkanten N = Number of cutting edges	LMT-Code	l	d	s	d ₁	r	LCP40M	LCPM40M	LCPK30M	LCP25M	LCPK10M	LCM45M		LCM44M	LCKP30M	LCKP10M	LCK20M	LCK10M	LCN10M	LWN10M	LCHP15M	LCH05M		
 N = 4	SAHT 1005 AA ER	10	10	5,56	4,4	0,8	9197815				7002745				9197816		7048354		9206753				FCT45 FMV45	
	SAHT 1306 AA EN	13,5	13,5	6,35	5,5	0,8	1054040				7002747				1054045		7048355		9206774					
 N = 4	SAKT 1005 AA ER	10	10	5,56	4,4	0,8						9206751	9206752											FCT45 FMV45
	SAKT 1306 AA EN	13,5	13,5	6,35	5,5	0,8						9206754	9206755											
 N = 4	SEHT 1204 AFFN-ALC	12,7	12,7	4,76	4,4	-														7219991				FMH45
	SEHT 1204 AFEN-ALC	12,7	12,7	4,76	4,4	-												7251435						
 N = 4	SEHT 1204 AFFN-ALC	12,7	12,7	4,76	5,5	-								1068538						1068537				
	SEHT 1204 AFSN-BM	12,7	12,7	4,76	5,5	-						1067533												
	SEKT 1204 AFSN	12,7	12,7	4,76	5,5	-	1067495																	

= Hauptanwendung First choice
 = Nebenanwendung Second choice
 Sortenbeschreibung/-bezeichnung und ISO-Code ab Seite 424/477
 Description/Designation of grades and ISO-Code starting page 424/477
 Weitere RD.../RN... Schneidplatten ab Seite 449
 Further RD.../RN... Inserts starting page 449

■			■	□	□		□																	P
□						■	■																	M
								□				■	■											K
																			■	■				N
																								S
																								H

N = Anzahl der Schneidkanten N = Number of cutting edges	LMT-Code	l	d	s	d ₁	b/r	Schneidstoffsorten Cutting materials Ident No.												Für Fräser For cutter Cat-No.																																																																																																																																																		
							LCP40M	LCPM40M	LCPK30M	LCP25M	LCPK10M	LCM45M	LCMS35M	LCKP30M	LCKP10M	LCK20M	LCK10M	LCN10M		LWN10M	LCHP15M	LCM44M																																																																																																																																															
 N = 4	SEKT 1204 AFEN-BM	12,7	12,7	4,76	4,4	-	7219987							7219988										FMH45																																																																																																																																													
 N = 4	SEKT 1204 AFSN	12,7	12,7	4,76	4,4	-	7219983		7219984					7219985		7219986								FMH45																																																																																																																																													
 N = 4	SEKT 1204 AFSN-BMS	12,7	12,7	4,76	4,4	-	7219989							7219990										FMH45																																																																																																																																													
 N = 4	SNHX 1205 AE IN 1187-18 TR-IN	12,7	12,7	5,56	5,2	2								1067543																																																																																																																																																							
	SNHX 1205 AESN-BM	12,7	12,7	5,56	5,2	2																	1067537																																																																																																																																														
■ = Hauptanwendung First choice □ = Nebenanwendung Alternative																																																																																																																																																																					
<table border="1"> <tr><td>■</td><td>■</td><td>□</td><td>□</td><td>□</td><td></td><td></td><td></td><td></td><td></td><td></td><td></td><td></td><td></td><td></td><td></td><td></td><td></td><td></td><td></td><td></td><td></td><td></td><td>P</td></tr> <tr><td>□</td><td></td><td></td><td></td><td>■</td><td>■</td><td></td><td></td><td></td><td></td><td></td><td></td><td></td><td></td><td></td><td></td><td></td><td></td><td></td><td></td><td></td><td></td><td></td><td>M</td></tr> <tr><td></td><td></td><td>□</td><td></td><td></td><td></td><td></td><td></td><td></td><td></td><td>■</td><td></td><td></td><td></td><td></td><td></td><td></td><td></td><td></td><td></td><td></td><td></td><td></td><td>K</td></tr> <tr><td></td><td></td><td></td><td></td><td></td><td></td><td></td><td></td><td></td><td></td><td></td><td></td><td></td><td></td><td></td><td></td><td></td><td></td><td></td><td></td><td></td><td></td><td></td><td>N</td></tr> <tr><td></td><td></td><td></td><td></td><td></td><td></td><td></td><td></td><td></td><td></td><td></td><td></td><td></td><td>■</td><td></td><td></td><td></td><td></td><td></td><td></td><td></td><td></td><td></td><td>S</td></tr> <tr><td></td><td></td><td></td><td></td><td></td><td></td><td></td><td></td><td></td><td></td><td></td><td></td><td></td><td></td><td></td><td></td><td></td><td></td><td></td><td></td><td></td><td></td><td></td><td>H</td></tr> </table>																						■	■	□	□	□																			P	□				■	■																		M			□								■													K																								N														■										S																								H
■	■	□	□	□																			P																																																																																																																																														
□				■	■																		M																																																																																																																																														
		□								■													K																																																																																																																																														
																							N																																																																																																																																														
													■										S																																																																																																																																														
																							H																																																																																																																																														

N = Anzahl der Schneidkanten N = Number of cutting edges	LMT-Code	l	d	s	d ₁	b	Schneidstoffsorten Cutting materials Ident No.												Für Fräser For cutter Cat-No.									
							LCP40M	LCPM40M	LCP35M	LCP25M	LCPK10M	LCM45M	LCMS35M	LCKP30M	LCKP10M	LCK20M	LCK10M	LCN10M		LWN10M	LCHP15M	LCH05M						
<p>N = 8</p>	SOKX 1505 ABER	15,875	15,875	6,03	5,7	2,7			7098271						7098273				7098272						FMP45			
	<p>N = 4</p>	SPKX 090406 1187-05	9,52	9,52	4,76	4,4	0,6												1069548							FMT90		
		SPKX 120508 1187-15	12,7	12,7	5,56	5,2	0,8			1052247										1052659				1052242				
<p>N = 4</p>	SPMT 120408 SN	12,7	12,7	4,76	5,2	0,8			2308343										1055660				1069295			EFZ45		
	<p>N = 8</p>	SPMW 120408	12,7	12,7	4,76	5,2	0,8			1069128										1069232					1069231		EFZ45	
							■	■					□	□												P		
							□	□				■															M	
																			■	■							K	
																								■			N	
																										■	S	
																											■	H

■ = Hauptanwendung First choice
□ = Nebenanwendung Second choice
Sortenbeschreibung/-bezeichnung und ISO-Code ab Seite 424/477
Description/Designation of grades and ISO-Code starting page 424/477

N = Anzahl der Schneidkanten N = Number of cutting edges	LMT-Code	l	d	s	d ₁	r	Schneidstoffsorten Cutting materials Ident No.											Für Fräser For cutter Cat-No.							
							LCP40M	LCPM40M	LCPK30M	LCP25M	LCPK10M	LCM45M	LCM44M	LCKP30M	LCKP10M	LCK20M	LCK10M		LCN10M	LWN10M	LCHP15M	LCH05M			
N = 3	TCMT 110202 1166-00	11	6,35	2,4	2,8	0,2									7075668									EFZ45T11 EFZ60T11 EFZ30T16 EFZ45T16 EFZ60T16	
	TCMT 16T304 1166-10	16,5	9,52	3,97	4,3	0,4									7075679										
N = 2	VPGT 110504 ALM	11,61	6,35	3,18	2,8	0,4												1069756						EMZ90 FMZ90	
	VPGT 160412 ALM	16,6	12,7	4,76	4,4	1,2												1069758							
	VCGT 220530 ALM	22,1	12,7	5,56	5,5	3												1069760							
N = 12	XCKX 1606 ZDR-TR	16	16	6,35	5,8	0,5	1055677																	FCT45	
N = 4	XCNT 070308 EN-TR	7,94	7,94	3,18	3,4	0,8			9186375		9186376													ECP FCP	
	XCNT 09T312 EN-TR	9,52	9,52	3,97	3,8	1,2			9186350		9186351														
	XCNT 120520 EN-TR	12,7	12,7	5,56	5,2	2,0			9186206		9186207														

■ = Hauptanwendung First choice
□ = Nebenanwendung Alternative

Sortenbeschreibung/-bezeichnung und ISO-Code ab Seite 424/477
Description/Designation of grades and ISO-Code starting page 424/477

■	■	■	■	■	■						□														P
□	□			□																					M
											□														K
																									N
																									S
																									H

							Schneidstoffsorten Cutting materials Ident No.										Für Fräser For cutter Cat-No.												
N = Anzahl der Schneidkanten N = Number of cutting edges	LMT-Code	l	d	s	d ₁	r	LCP40M	LCPM40M	LCPK30M	LCP25M	LCPK10M	LCM45M	LCM44M	LCKP30M	LCKP10M	LCK20M		LCK10M	LCN10M	LWN10M	LCHP15M	LCH05M							
<p>N = 4</p>	XCNT 070308 SN-TR	7,94	7,94	3,18	3,4	0,8		1058100								7047949	1058101	1058106					ECP FCP						
	XCNT 09T312 SN-TR	9,52	9,52	3,97	3,8	1,2		1058102								7047950	1058103	1058107											
	XCNT 120520 SN-TR	12,7	12,7	5,56	5,2	2,0		1058104								7047951	1058105	1058108											
<p>N = 4</p>	XCNT 09T312 EN	9,52	9,52	3,97	3,8	1,2		7159747						7159748		7159749								ECP FCP					
	XCNT 120520 EN	12,7	12,7	5,56	5,2	2,0		7159750					7159751																
<p>N = 4</p>	XCNW 070308 SN	7,94	7,94	3,18	3,4	0,8		9186492			9186493				9186494	7047952								ECP FCP					
	XCNW 09T312 SN	9,52	9,52	3,97	3,8	1,2		9186440			9186441				9186442	7047953													
	XCNW 120520 SN	12,7	12,7	5,56	5,2	2,0		9186431			9186432				9186433	7047954													
■ = Hauptanwendung First choice □ = Nebenanwendung Alternative Sortenbeschreibung/-bezeichnung und ISO-Code ab Seite 424/477 Description/Designation of grades and ISO-Code starting page 424/477							■	■	■	■	□																		P
							□	□	□		■															M			
											□						■	■									K		
																■			■								N		
																											S		
																											H		

		Schneidstoffsorten Cutting materials Ident No.											Für Fräser For cutter Cat-No.																																																																																																																																																								
N = Anzahl der Schneidkanten N = Number of cutting edges	LMT-Code	l	d	s	d ₁	b/r	LCP40M	LCPM40M	LCPK30M	LCP25M	LCPK10M	LCM45M		LCMS35M	LCKP30M	LCKP10M	LCK20M	LCK10M	LCN10M	LWN10M	LCHP15M	LCH05M																																																																																																																																															
	XDMT 090308 ER	9	6	3	2,8	1,5	7139507								7139508								EHP IK FHP IK																																																																																																																																														
	XDMT 090316 ER	9	6	3	2,8	2,0	7154734																																																																																																																																																														
N = 2																																																																																																																																																																					
	XDMW 090308 SR	9	6	3	2,8	1,5	7139504								7139506								EHP IK FHP IK																																																																																																																																														
	XDMW 090316 SR	9	6	3	2,8	2,0	7154732				7202194										7258691																																																																																																																																																
N = 2																																																																																																																																																																					
	XNMU 120608 ER	12	12	6,35	4,4	0,8	7163384							7163385		7192762							FMP90T X																																																																																																																																														
N = 8																																																																																																																																																																					
	XOKX 1606 ZD-TR	16	16	6,35	5,8	0,5	1054021	1054023		1054020	1054024				1054022								FCT45																																																																																																																																														
N = 4																																																																																																																																																																					
■ = Hauptanwendung First choice □ = Nebenanwendung Alternative							<table border="1"> <tr><td>■</td><td></td><td></td><td></td><td></td><td></td><td></td><td></td><td></td><td></td><td></td><td></td><td></td><td></td><td></td><td></td><td></td><td></td><td></td><td></td><td></td><td></td><td></td><td>P</td></tr> <tr><td>□</td><td></td><td></td><td></td><td></td><td></td><td></td><td></td><td></td><td></td><td></td><td></td><td></td><td></td><td></td><td></td><td></td><td></td><td></td><td></td><td></td><td></td><td></td><td>M</td></tr> <tr><td></td><td></td><td></td><td></td><td></td><td></td><td></td><td></td><td></td><td></td><td></td><td></td><td></td><td></td><td></td><td></td><td></td><td></td><td></td><td></td><td></td><td></td><td></td><td>K</td></tr> <tr><td></td><td></td><td></td><td></td><td></td><td></td><td></td><td></td><td></td><td></td><td></td><td></td><td></td><td></td><td></td><td></td><td></td><td></td><td></td><td></td><td></td><td></td><td></td><td>N</td></tr> <tr><td></td><td></td><td></td><td></td><td></td><td></td><td></td><td></td><td></td><td></td><td></td><td></td><td></td><td></td><td></td><td></td><td></td><td></td><td></td><td></td><td></td><td></td><td></td><td>S</td></tr> <tr><td></td><td></td><td></td><td></td><td></td><td></td><td></td><td></td><td></td><td></td><td></td><td></td><td></td><td></td><td></td><td></td><td></td><td></td><td></td><td></td><td></td><td></td><td></td><td>H</td></tr> </table>															■																							P	□																							M																								K																								N																								S																								H
■																							P																																																																																																																																														
□																							M																																																																																																																																														
																							K																																																																																																																																														
																							N																																																																																																																																														
																							S																																																																																																																																														
																							H																																																																																																																																														

N = Anzahl der Schneidkanten N = Number of cutting edges	LMT-Code						Schneidstoffsorten Cutting materials Ident No.										Für Fräser For cutter Cat-No.							
		l	d	s	d ₁	b/r	LCP40M	LCPM40M	LCPK30M	LCP25M	LCPK10M	LCM45M	LCM44M	LCKP30M	LCKP10M	LCK20M		LCK10M	LCN10M	LWN10M	LCHP15M	LCH05M		
N = 3	XPMPW 070308 SR	-	6,79	2,78	2,8	0,8	7160173					7160174			7160175							ECP IK		
	XPHW 070308 SR	-	6,79	2,78	2,8	0,8		1058192							1058193									
N = 3	XPMT 070308 ER	-	6,79	2,78	2,8	0,8	7160176					7160177			7160178							ECP IK		
N = 2	1179-11	15,191	7,04	3,18	3,4	8	1069575															EBT		
	1179-21	18,989	8,8	3,97	4,2	10	1069581								1069583									
	1179-41	30,382	14,08	5,56	5,8	16	1069589																	
N = 2	1179-25	12,79	7,15	3,18	3,5	10	1069560								1069562							EBT		
	1179-35	15,99	8,94	3,97	4,1	12,5	1069563								1069564									
	1179-45	20,47	11,44	5,08	4,5	16	1069565								1069566									
	1179-55	25,58	14,3	6,35	5,5	20	1069567																	
							■	■			□			□								P		
							□	□			■												M	
															■									K
																								N
												□												S
																								H

■ = Hauptanwendung First choice
□ = Nebenanwendung Alternative

Sortenbeschreibung/-bezeichnung und ISO-Code ab Seite 424/477
Description/Designation of grades and ISO-Code starting page 424/477



		Schneidstoffsorten Cutting materials Ident No.										Für Fräser For cutter Cat-No.					
		LWP40M	LWNS90M	LWNS10M	LWNS33M	LCP40M	LCPK30M	LCPK10M	LCPK25M	LCPK15M	LCKP10M		LCHK10M	LCMS35M	LCN10M	LDN10M	
N = Anzahl der Schneidkanten N = Number of cutting edges	LMT-Code	l	d	s	d ₁	r											
	CMR 12 SR	12,5	12	3	4,5	6											EBC R 12
	CMR 16 SR	16,5	16	3	5,2	8											EBC R 16
	CMR 20 SR	21,5	20	4	5,7	10											EBC R 20
	CMR 25 SR	27	25	5	6,2	12,5											EBC R 25
N = 2																	
	CMR 16 DR	18	16	3	5,2	8			7167186								EBC R 16
	CMR 20 DR	23	20	4	5,7	10			7167187								EBC R 20
	CMR 25 DR	28	25	5	6,2	12,5			7167188								EBC R 25
	CMR 32 DR	35	32	6	8,9	16			7189771								
N = 2																	
■ = Hauptanwendung First choice □ = Nebenanwendung Alternative																	
Sortenbeschreibung/-bezeichnung und ISO-Code ab Seite 424/477 Description/Designation of grades and ISO-code starting page 424/477																	
																	P
																	M
																	K
																	N
																	S
																	H

							Schneidstoffsorten Cutting materials Ident No.										Für Fräser For cutter Cat-No.									
N = Anzahl der Schneidkanten N = Number of cutting edges	LMT-Code	l	d	s	d ₁	r	LWP40M	LWNS30M	LWNS10M	LWNS33M	LCP40M	LCPK30M	LCPK10M	LCPK25M	LCPK15M	LCKP10M		LCHK10M	LCH33M	LCNT10M	LDNT10M					
<p>N = 2</p>	CPHX 050210	-	4,76	2,38	-	1										7093853						ECG FCG				
	CPHX 080310	-	7,93	3,18	-	1										7108610										
															■						P					
																	□						M			
																	■							K		
																									N	
																										S
																	■									H

■ = Hauptanwendung First choice
□ = Nebenanwendung Alternative

PKD & CBN bestückte Schneidplatten auf Anfrage
PKD & CBN tipped inserts on request

Sortenbeschreibung/-bezeichnung und ISO-Code ab Seite 424/477
Description/Designation of grades and ISO-Code starting page 424/477



		Schneidstoffsorten Cutting materials Ident No.										Für Fräser For cutter																																																																																																																												
N = Anzahl der Schneidkanten N = Number of cutting edges	LMT-Code	l	d	s	d ₁	r	LC280QN	LCKP28M	LCKP30M	LCKP20M	LC228E	LCP35M	LC240T	LC610T	LCPK20M	LC603Z	LBHK85M	Cat-No.																																																																																																																						
 	RDKX 1604 MO E	-	16	4,76	5,2	-						7112984						ECC FCC ECZ FCZ																																																																																																																						
	RDKX 1604 MO S	-	16	4,76	5,2	-		7041694	7119317		7004651						7035554																																																																																																																							
	RDHW 1604 MO S	-	16	4,76	5,2	-							1068616	1068627																																																																																																																										
	RDHX 1604 MO S	-	16 ±0,01	4,76	5,2	-											1055762																																																																																																																							
 <p>N = abhängig von der Einstelltiefe depending on depth of positioning</p>	RDKT 0702 MO-TT	-	7	2,38	2,7	-	7077266 ⁽¹⁾											ECC ECZ FCC FCZ																																																																																																																						
	RDKT 1003 MO-TT	-	10	3,18	3,8	-	7077268 ⁽¹⁾																																																																																																																																	
	RDKX 12T3 MO-TT	-	12	3,97	3,8	-	7077271 ⁽¹⁾																																																																																																																																	
	RDKT 1604 MO-TT	-	16	4,76	5,2	-	7077270 ⁽¹⁾																																																																																																																																	
<p>■ = Hauptanwendung First choice □ = Nebenanwendung Alternative</p> <p>Sortenbeschreibung/-bezeichnung und ISO-Code ab Seite 424/477 Description/Designation of grades and ISO-Code starting page 424/477</p> <p>Weitere RD... Schneidplatten ab Seite 436 Further RD... Inserts starting page 436</p>							<table border="1"> <tr> <td>■</td><td>■</td><td>■</td><td>■</td><td>■</td><td>■</td><td>■</td><td>■</td><td>■</td><td>■</td><td>■</td><td>■</td><td>■</td><td>■</td><td>■</td><td>■</td><td>■</td><td>■</td><td>■</td><td>P</td> </tr> <tr> <td>□</td><td>■</td><td>■</td><td>■</td><td>■</td><td>■</td><td>■</td><td>■</td><td>■</td><td>■</td><td>■</td><td>■</td><td>■</td><td>■</td><td>■</td><td>■</td><td>■</td><td>■</td><td>■</td><td>M</td> </tr> <tr> <td>■</td><td>■</td><td>■</td><td>■</td><td>■</td><td>■</td><td>■</td><td>■</td><td>■</td><td>■</td><td>■</td><td>■</td><td>■</td><td>■</td><td>■</td><td>■</td><td>■</td><td>■</td><td>■</td><td>K</td> </tr> <tr> <td>■</td><td>■</td><td>■</td><td>■</td><td>■</td><td>■</td><td>■</td><td>■</td><td>■</td><td>■</td><td>■</td><td>■</td><td>■</td><td>■</td><td>■</td><td>■</td><td>■</td><td>■</td><td>■</td><td>N</td> </tr> <tr> <td>■</td><td>■</td><td>■</td><td>■</td><td>■</td><td>■</td><td>■</td><td>■</td><td>■</td><td>■</td><td>■</td><td>■</td><td>■</td><td>■</td><td>■</td><td>■</td><td>■</td><td>■</td><td>■</td><td>S</td> </tr> <tr> <td>■</td><td>■</td><td>■</td><td>■</td><td>■</td><td>■</td><td>■</td><td>■</td><td>■</td><td>■</td><td>■</td><td>■</td><td>■</td><td>■</td><td>■</td><td>■</td><td>■</td><td>■</td><td>■</td><td>H</td> </tr> </table>										■	■	■	■	■	■	■	■	■	■	■	■	■	■	■	■	■	■	■	P	□	■	■	■	■	■	■	■	■	■	■	■	■	■	■	■	■	■	■	M	■	■	■	■	■	■	■	■	■	■	■	■	■	■	■	■	■	■	■	K	■	■	■	■	■	■	■	■	■	■	■	■	■	■	■	■	■	■	■	N	■	■	■	■	■	■	■	■	■	■	■	■	■	■	■	■	■	■	■	S	■	■	■	■	■	■	■	■	■	■	■	■	■	■	■	■	■	■	■	H
■	■	■	■	■	■	■	■	■	■	■	■	■	■	■	■	■	■	■	P																																																																																																																					
□	■	■	■	■	■	■	■	■	■	■	■	■	■	■	■	■	■	■	M																																																																																																																					
■	■	■	■	■	■	■	■	■	■	■	■	■	■	■	■	■	■	■	K																																																																																																																					
■	■	■	■	■	■	■	■	■	■	■	■	■	■	■	■	■	■	■	N																																																																																																																					
■	■	■	■	■	■	■	■	■	■	■	■	■	■	■	■	■	■	■	S																																																																																																																					
■	■	■	■	■	■	■	■	■	■	■	■	■	■	■	■	■	■	■	H																																																																																																																					

							Schneidstoffsorten Cutting materials Ident No.										Für Fräser For cutter Cat-No.	
N = Anzahl der Schneidkanten N = Number of cutting edges	LMT-Code	l	d	s	d ₁	r	LCS40M	LCM35M	LCKP20M	LCKP28M	LCPK20M	LCPK30M	LCPK15M	LWNS10M	LCH05M	LBHK85M		
	RNLU 1204 MO M	-	12	4,75	4,57	-	7207971	7207970									ECC FCC	
	RNLU 1204 MO R	-	12	4,75	4,57	-						7222375	7222374					
	RNKX 1605 MO	-	16	4,76	5,2	-			7089594		7083759						FCC	
																	P	
																		M
																		K
																		N
																		S
																		H

■ = Hauptanwendung First choice
□ = Nebenanwendung Alternative

Sortenbeschreibung/-bezeichnung und ISO-Code ab Seite 424/477
Description/Designation of grades and ISO-Code starting page 424/477

Weitere RD... Schneidplatten ab Seite 436
Further RD... Inserts starting page 436

N = Anzahl der Schneidkanten N = Number of cutting edges	LMT-Code	l	d	s	d ₁	r	Schneidstoffsorte Cutting material Ident No.										Für Fräser For cutter Cat-No.					
							LWP40M	LCP40M	LWNS30M	LCPK30M	LCHK30M	LWNS10M	LCPK10M	LCKP10M	LCHK10M	LCN10M		LWNS33M	LCH33M	LBHK95M	LBHK85M	
 N = 4	SPGW 09T3 S	9,25	9,5	3,97	-	0,4														7060826	SpeedLift	
 N = 3	TPEW 1303 SR	8	-	3	-	0,4														7070422	SpeedLift	
■ = Hauptanwendung First choice □ = Nebenanwendung Alternative																						
Sortenbeschreibung/-bezeichnung und ISO-Code ab Seite 424/477 Description/Designation of grades and ISO-Code starting page 424/477																						
																					P	
																				M		
																			■	K		
																				N		
																				S		
																				H		

							Schneidstoffsorten Cutting materials Ident No.										Für Fräser For cutter					
N = Anzahl der Schneidkanten N = Number of cutting edges	LMT-Code	l	d	s	d ₁	r	LWP40M	LWNS30M	LWNS10M	LWNS33M	LCP40M	LCPK30M	LCPK10M	LCPK25M	LCPK15M	LCKP10M	LCHK10M	LCH33M	LCN10M	LDN10M	Cat-No.	
 N = 2	WPB 06 AF 05	8	6	1,6	2,5	0,5									7214345		7035106		7132591		EBG R 06	
	WPB 08 AF 05	9,3	8	2	3	0,5			7107679						7214346		7062287		7132592		EBG V 08	
	WPB 08 AF 10	9,5	8	2	3	1									7214347		7035107		7132593			
	WPB 10 AF 05	11,3	10	2,5	4	0,5			7107680						7214348		9193919		7132594		EBG V 10	
	WPB 10 AF 10	11,5	10	2,5	4	1			7016821						7214350		9153134		7132595			
	WPB 12 AF 05	13,8	12	2,5	5	0,5			7107681						7214351		7016356		7132596		EBG V 12	
	WPB 12 AF 10	14	12	2,5	5	1			7016822						7214352		9153135		7132597			
	WPB 12 AF 20	14	12	2,5	5	2									7214354		9153137					
	WPB 16 AF 10	16	16	3	5	1			7016823						7214355		9148026		7132599		EBG V 16	
	WPB 16 AF 30	16	16	3	5	3									7214357		9148028					
	WPB 20 AF 10	18	20	3	5	1			7016824						7214359		9153138		7132601		EBG V 20	
	WPB 20 AF 20	18	20	3	5	2									7214360		7043485					
	WPB 20 AF 40	18	20	3	5	4									7214361		9153169					

■ = Hauptanwendung First choice
□ = Nebenanwendung Alternative

Sortenbeschreibung/-bezeichnung und ISO-Code ab Seite 424/477
Description/Designation of grades and ISO-Code starting page 424/477

Alle WPR-, WPV- und WPB-Wendepetten sind in der Sorte LCN10M (diamantbeschichtet) oder PKD/CBN-bestückt auf Anfrage lieferbar.
All WPR, WPV and WPB inserts are available in grade LCN10M (diamond coated) or PCD/CBN tipped.

																						P
																						M
																						K
																						N
																						S
																						H

		Schneidstoffsorten Cutting materials Ident No.										Für Fräser For cutter									
N = Anzahl der Schneidkanten N = Number of cutting edges	LMT-Code	l	d	s	d ₁	r	LWP40M	LWNS30M	LWNS10M	LWNS33M	LCP40M	LCPK30M	LCPK10M	LCPK25M	LCPK15M	LCKP10M	LCHK10M	LCH33M	LCN10M	LBHK95M	Cat-No.
<p>N = 2</p>	WPB 06 FB 20	8	6	1,6	2,5	2										9112332					EBG R 06
	WPB 08 FB 30	9,5	8	2	3	3										9112328					EBG R 08
	WPB 10 FB 40	11,5	10	2,5	4	4										9097607					EBG R 10
	WPB 12 FB 50	14	12	2,5	5	5										9097606			9078092		EBG R 12
	WPB 16 FB 70	16	16	3	5	7										9095870			9078091		EBG R 16
	WPB 20 FB 90	18	20	3	5	9										9097608			9080149		EBG R 20

■ = Hauptanwendung First choice
□ = Nebenanwendung Alternative

Sortenbeschreibung/-bezeichnung und ISO-Code ab Seite 424/477
Description/Designation of grades and ISO-Code starting page 424/477

Alle WPR-, WPV- und WPB-Wendepplatten sind in der Sorte LCN10M (diamantbeschichtet) oder PKD/CBN-bestückt auf Anfrage lieferbar.
All WPR, WPV and WPB inserts are available in grade LCN10M (diamond coated) or PCD/CBN tipped.

																■						P
																□						M
																■			■			K
																						N
																						S
																□			■			H

		Schneidstoffsorten Cutting materials													Für Fräser For cutter								
		Ident No.																					
N = Anzahl der Schneidkanten N = Number of cutting edges	LMT-Code	l	d	s	d ₁	r _{theo.}	LWP40M	LWNS30M	LWNS10M	LWNS33M	LCP40M	LCPK30M	LCPK10M	LCPK25M	LCPK15M	LCKP10M	LCHK10M	LCH33M	LCN10M	LDN10M	Cat-No.		
 N = 2	WPB 06 HF	8	6	1,6	2,5	0,6		7245032	7016142 ¹⁾			7245030	9200283 ¹⁾	7214333								EBG R 06	
	WPB 08 HF	9,5	8	2	3	0,8		7245033	7016143 ¹⁾			7132044	9200268 ¹⁾	7214334								EBG V 08	
	WPB 10 HF	11,5	10	2,5	4	1,0		7245034	7016144 ¹⁾			7132045	9103211 ¹⁾	7214335								EBG V 10	
	WPB 12 HF	14	12	2,5	5	1,2		7245035	7016145			6132176		7214336								EBG V 12	
	WPB 16 HF	16	16	3	5	1,6		7016148			6132180		7214337									EBG V 16	
	WPB 20 HF	18	20	3	5	2,0		7016150			6132182		7214338									EBG V 20	
	WPB 25 HF	23,5	25	4	6	2,5		9087093				6183263 ¹⁾	7214339									EBG V 25	
	WPB 32 HF	26,5	32	5	8	3,2		7245031				6183264 ¹⁾	7214340									EBG V 32	
											■	■	■									P	
													□										M
												■	■	■									K
											■	■											N
											■	■											S
													□										H

¹⁾ nur noch lieferbar, solange Vorrat reicht (Ersatz: LWNS30M, LCPK30M)
Only available while stock lasts (substitute: LWNS30M, LCPK30M)

■ = Hauptanwendung First choice
□ = Nebenanwendung Alternative

Sortenbeschreibung/-bezeichnung und ISO-Code ab Seite 424/477
Description/Designation of grades and ISO-Code starting page 424/477

Alle WPR-, WPV- und WPB-Wendepplatten sind in der Sorte LCN10M (diamantbeschichtet) oder PKD/CBN-bestückt auf Anfrage lieferbar.
All WPR, WPV and WPB inserts are available in grade LCN10M (diamond coated) or PCD/CBN tipped.

							Schneidstoffsorten Cutting materials Ident No.										Für Fräser For cutter Cat-No.						
N = Anzahl der Schneidkanten N = Number of cutting edges	LMT-Code	l	d	s	d ₁	r	LWP40M	LWNS30M	LWNS10M	LWNS33M	LCP40M	LCPK30M	LCPK10M	LCPK25M	LCPK15M	LCKP10M		LCHK10M	LCH33M	LCN10M	LCH33M		
 N = 2	WPB 08 N 06	9,5	8	2	3	0,6			6282921						7214312	7108320						EBG V 08	
	WPB 08 N 10	9,5	8	2	3	1			6282916						7214313	7108321							
	WPB 10 N 08	11,5	10	2,5	4	0,8			6282922						7214314	7108323						EBG V 10	
	WPB 10 N 10	11,5	10	2,5	4	1			6282917						7214315	7108324							
	WPB 12 N 10	14	12	2,5	5	1			6129226						7214316	7108325						EBG V 12	
	WPB 12 N 20	14	12	2,5	5	2			6128105						7214317	7108326							
	WPB 16 N 10	16	16	3	5	1			6129228						7214318	7108404						EBG V 16	
	WPB 16 N 13	16	16	3	5	1,3			6282923						7214319	7108406							
	WPB 16 N 30	16	16	3	5	3			6128109						7214320	7108407							
														■	■						P		
															□	□						M	
															■	■						K	
								■														N	
								□							□								S
															□								H

■ = Hauptanwendung First choice
□ = Nebenanwendung Alternative

Sortenbeschreibung/-bezeichnung und ISO-Code ab Seite 424/477
Description/Designation of grades and ISO-Code starting page 424/477

Alle WPR-, WPV- und WPB-Wendepplatten sind in der Sorte LCN10M (diamantbeschichtet) oder PKD/CBN-bestückt auf Anfrage lieferbar.

All WPR, WPV and WPB inserts are available in grade LCN10M (diamond coated) or PCD/CBN tipped.

Wendeschneidplatten
Indexable inserts

							Schneidstoffsorten Cutting materials Ident No.											Für Fräser For cutter Cat-No.					
N = Anzahl der Schneidkanten N = Number of cutting edges	LMT-Code	l	d	s	d ₁	r	LWP40M	LWNS30M	LWNS10M	LWNS33M	LCP40M	LCPK30M	LCPK10M	LCPK25M	LCPK15M	LCKP10M	LCHK10M		LCH33M	LCN10M	LDN10M		
 N = 2	WPB 06 CF 05	8	6	1,6	2,5	0,5			6129234				9075747							6282824		EBG R 06	
	WPB 08 CF 10	9,5	8	2	3	1			6129236				7014307							6282825		EBG V 08	
	WPB 10 CF 10	11,5	10	2,5	4	1			6129238				7006341							6282826		EBG V 10	
	WPB 12 CF 10	14	12	2,5	5	1			6282909				7014312							6282827		EBG V 12	
	WPB 12 CF 20	14	12	2,5	5	2			6128107				7016146										
	WPB 16 CF 10	16	16	3	5	1			6282910				7014313							6282828		EBG V 16	
	WPB 16 CF 30	16	16	3	5	3			6128111				7016149										
	WPB 20 CF 10	18	20	3	5	1			6282911				7014308										EBG V 20
	WPB 20 CF 40	18	20	3	5	4			6128115				7016151										
	WPB 25 CF 10	23,5	25	4	6	1			6282912				7014314										EBG V 25
	WPB 25 CF 50	23,5	25	4	6	5			6128119				7016152										
													■									P	
													□										M
																							K
																				■			N
																				□			S
																							H

■ = Hauptanwendung First choice
□ = Nebenanwendung Alternative

Sortenbeschreibung/-bezeichnung und ISO-Code ab Seite 424/477
Description/Designation of grades and ISO-Code starting page 424/477

Alle WPR-, WPV- und WPB-Wendepplatten sind in der Sorte LCN10M (diamantbeschichtet) oder PKD/CBN-bestückt auf Anfrage lieferbar.

All WPR, WPV and WPB inserts are available in grade LCN10M (diamond coated) or PKD/CBN tipped.

 N = Anzahl der Schneidkanten N = Number of cutting edges		Schneidstoffsorten Cutting materials Ident No.											Für Fräser For cutter Cat-No.					
		LWP40M	LWNS30M	LWNS10M	LWNS33M	LCP40M	LCPK30M	LCPK10M	LCPK25M	LCPK15M	LCKP10M	LCHK30M		LCH33M	LCN10M	LDN10M		
 N = 2	WPR 12 AR	-	12	2,5	5	6												EBG R 12
	WPR 16 AR	-	16	3	5	8												EBG R 16
	WPR 20 AR	-	20	3	5	10												EBG R 20
 N = 2	WPR 25 AR	-	25	4	6	12,5												EBG R 25
	WPR 32 AR	-	32	5	8	16												EBG R 32
																	P	
																	M	
																	K	
																	N	
																	S	
																	H	

■ = Hauptanwendung First choice
□ = Nebenanwendung Alternative

Sortenbeschreibung/-bezeichnung und ISO-Code ab Seite 424/477
Description/Designation of grades and ISO-Code starting page 424/477

Alle WPR-, WPV- und WPB-Wendplatten sind in der Sorte LCN10M (diamantbeschichtet) oder PKD/CBN-bestückt auf Anfrage lieferbar.
All WPR, WPV and WPB inserts are available in grade LCN10M (diamond coated) or PCD/CBN tipped.

		Schneidstoffsorten Cutting materials											Für Fräser For cutter												
		Ident No.																							
N = Anzahl der Schneidkanten N = Number of cutting edges	LMT-Code	l	d	s	d ₁	r	LWP40M	LCP40M	LWNS30M	LCPK30M	LCHK30M	LWNS10M	LCPK10M	LCKP10M	LCHK10M	LCN10M	LWNS33M	LCH33M	LBHK95M	LDN10M	Cat-No.				
	WPR 25 AS	-	25	4	6	12,5			9120404												EBG R 25				
	WPR 32 AS	-	32	5	8	16			9120405													EBG R 32			
N = 2																									
	WPS A	6	12	4	-	-						6122405										EBG T ..			
N = 2																									
■ = Hauptanwendung First choice □ = Nebenanwendung Alternative Sortenbeschreibung/-bezeichnung und ISO-Code ab Seite 424/477 Description/Designation of grades and ISO-Code starting page 424/477 Alle WPR-, WPV- und WPB-Wendepplatten sind in der Sorte LCN10M (diamantbeschichtet) oder PKD/CBN-bestückt auf Anfrage lieferbar. All WPR, WPV and WPB inserts are available in grade LCN10M (diamond coated) or PCD/CBN tipped.																									
																							P		
																							M		
																							K		
																							N		
																							S		
																							H		

		Schneidstoffsorten Cutting materials Ident No.											Für Fräser For cutter Cat-No.																																																																																																															
		LWP40M	LWNS30M	LWNS10M	LWNS33M	LCP40M	LCPK30M	LCPK10M	LCPK25M	LCPK15M	LCKP10M	LCHK10M		LCH33M	LCN10M	LDN10M																																																																																																												
N = Anzahl der Schneidkanten N = Number of cutting edges	LMT-Code	l	d	s	d ₁	r																																																																																																																						
<p>N = 2</p>	WPR 08 CF	-	8	2	3	4	6122958		6122963		9078159	6132336					EBG R 08																																																																																																											
	WPR 10 CF	-	10	2,5	4	5	6123051		6123043		9078160	6132337					EBG R 10																																																																																																											
	WPR 12 CF	-	12	2,5	5	6	6123030		6123024		9078161	6132338					EBG R 12																																																																																																											
	WPR 16 CF	-	16	3	5	8	6123029		6123006		6131685	6131617					EBG R 16																																																																																																											
	WPR 20 CF	-	20	3	5	10	6123011		6123004		9078163	6132339					EBG R 20																																																																																																											
	WPR 25 CF	-	25	4	6	12,5	6180001		6122984		9077244	6132341					EBG R 25																																																																																																											
	WPR 32 CF	-	32	5	8	16			6122979		9078164	6132342					EBG R 32																																																																																																											
<div style="display: flex; justify-content: space-between;"> <div style="width: 45%;"> <p>■ = Hauptanwendung First choice □ = Nebenanwendung Alternative</p> <p>Sortenbeschreibung/-bezeichnung und ISO-Code ab Seite 424/477 Description/Designation of grades and ISO-Code starting page 424/477</p> <p>Alle WPR-, WPV- und WPB-Wendepplatten sind in der Sorte LCN10M (diamantbeschichtet) oder PKD/CBN-bestückt auf Anfrage lieferbar. All WPR, WPV and WPB inserts are available in grade LCN10M (diamond coated) or PCD/CBN tipped.</p> </div> <div style="width: 45%; text-align: right;"> <table border="1"> <tr><td>■</td><td></td><td></td><td></td><td>■</td><td>■</td><td></td><td></td><td></td><td></td><td></td><td></td><td></td><td></td><td></td><td></td><td></td><td>P</td></tr> <tr><td></td><td></td><td></td><td></td><td></td><td></td><td></td><td></td><td></td><td></td><td></td><td></td><td></td><td></td><td></td><td></td><td></td><td>M</td></tr> <tr><td></td><td></td><td></td><td></td><td></td><td></td><td></td><td></td><td></td><td></td><td></td><td></td><td></td><td></td><td></td><td></td><td></td><td>K</td></tr> <tr><td></td><td></td><td></td><td></td><td></td><td></td><td></td><td></td><td></td><td></td><td></td><td></td><td></td><td></td><td></td><td></td><td></td><td>N</td></tr> <tr><td></td><td></td><td></td><td></td><td></td><td></td><td></td><td></td><td></td><td></td><td></td><td></td><td></td><td></td><td></td><td></td><td></td><td>S</td></tr> <tr><td></td><td></td><td></td><td></td><td></td><td></td><td></td><td></td><td></td><td></td><td></td><td></td><td></td><td></td><td></td><td></td><td></td><td>H</td></tr> </table> </div> </div>																	■				■	■												P																		M																		K																		N																		S																		H
■				■	■												P																																																																																																											
																	M																																																																																																											
																	K																																																																																																											
																	N																																																																																																											
																	S																																																																																																											
																	H																																																																																																											

		Schneidstoffsorten Cutting materials Ident No.											Für Fräser For cutter Cat-No.					
		LWP40M	LWNS30M	LWNS10M	LWNS33M	LCP40M	LCPK30M	LCPK10M	LCPK25M	LCPK15M	LCKP10M	LCHK10M		LCH33M	LCN10M	LDN10M		
N = Anzahl der Schneidkanten N = Number of cutting edges	LMT-Code	l	d	s	d ₁	r												
 N = 2	WPR 06 DN	-	6	1,6	2,5	3				6132363							9079232	EBG R 06
	WPR 08 DN	-	8	2	3	4				6131629	9074571						9074406	EBG R 08
	WPR 10 DN	-	10	2,5	4	5				6131302	9074574						6132330	EBG R 10
	WPR 12 DN	-	12	2,5	5	6				6131303	9074575						6132329	EBG R 12
	WPR 16 DN	-	16	3	5	8				6131304	9074576						9074409	EBG R 16
	WPR 20 DN	-	20	3	5	10				6131305	9074577						6132089	EBG R 20
	WPR 25 DN	-	25	4	6	12,5				6131306	9074578							EBG R 25
	WPR 32 DN	-	32	5	8	16				6131307	9074580							EBG R 32

■ = Hauptanwendung First choice
□ = Nebenanwendung Alternative

Sortenbeschreibung/-bezeichnung und ISO-Code ab Seite 424/477
Description/Designation of grades and ISO-Code starting page 424/477

Alle WPR-, WPV- und WPB-Wendepplatten sind in der Sorte LCN10M (diamantbeschichtet) oder PKD/CBN-bestückt auf Anfrage lieferbar.
All WPR, WPV and WPB inserts are available in grade LCN10M (diamond coated) or PCD/CBN tipped.

																		P
																		M
																		K
																		N
																		S
																		H

		Schneidstoffsorten Cutting materials Ident No.										Für Fräser For cutter Cat-No.																																																																																																															
		LWP40M	LWNS30M	LWNS10M	LWNS33M	LCP40M	LCPK30M	LCPK10M	LCPK25M	LCPK15M	LCKP10M		LCHK10M	LCH33M	LCN10M	LDN10M																																																																																																											
N = Anzahl der Schneidkanten N = Number of cutting edges	LMT-Code	l	d	s	d ₁	r																																																																																																																					
 N = 2	WPR 06 N	-	6	1,6	2,5	3								7214248	7108571		EBG R 06																																																																																																										
	WPR 08 N	-	8	2	3	4	6123058		6123047					7214252	7108479	7108486	EBG R 08																																																																																																										
	WPR 10 N	-	10	2,5	4	5	6123180		6123172					7214253	7108490	7108491	EBG R 10																																																																																																										
	WPR 12 N	-	12	2,5	5	6	6123159		6123153					7214254	7108498	7108499	EBG R 12																																																																																																										
	WPR 16 N	-	16	3	5	8	6123140		6123135					7214255	7108501	7108502	EBG R 16																																																																																																										
	WPR 20 N	-	20	3	5	10	6123122		6123117					7214256	7108503	7108505	EBG R 20																																																																																																										
	WPR 25 N	-	25	4	6	12,5	6180175		6123099					7214257	7108508	7108509	EBG R 25																																																																																																										
	WPR 30 N	-	30	5	6	15	6123065		6200388					7214258	7108512		EBG R 30																																																																																																										
	WPR 32 N	-	32	5	8	16	6180254		6123076					7214259	7108561	7108562	EBG R 32																																																																																																										
	■ = Hauptanwendung First choice □ = Nebenanwendung Alternative Sortenbeschreibung/-bezeichnung und ISO-Code ab Seite 424/477 Description/Designation of grades and ISO-Code starting page 424/477 Alle WPR-, WPV- und WPB-Wendeplatten sind in der Sorte LCN10M (diamantbeschichtet) oder PKD/CBN-bestückt auf Anfrage lieferbar. All WPR, WPV and WPB inserts are available in grade LCN10M (diamond coated) or PCD/CBN tipped.																																																																																																																										
<table border="1"> <tr><td>■</td><td></td><td></td><td></td><td></td><td></td><td></td><td></td><td></td><td></td><td></td><td></td><td></td><td></td><td></td><td></td><td></td><td>P</td></tr> <tr><td></td><td></td><td></td><td></td><td></td><td></td><td></td><td></td><td></td><td></td><td></td><td></td><td></td><td></td><td></td><td></td><td></td><td>M</td></tr> <tr><td></td><td></td><td></td><td></td><td></td><td></td><td></td><td></td><td></td><td></td><td></td><td></td><td></td><td></td><td></td><td></td><td></td><td>K</td></tr> <tr><td></td><td></td><td></td><td></td><td></td><td></td><td></td><td></td><td></td><td></td><td></td><td></td><td></td><td></td><td></td><td></td><td></td><td>N</td></tr> <tr><td></td><td></td><td></td><td></td><td></td><td></td><td></td><td></td><td></td><td></td><td></td><td></td><td></td><td></td><td></td><td></td><td></td><td>S</td></tr> <tr><td></td><td></td><td></td><td></td><td></td><td></td><td></td><td></td><td></td><td></td><td></td><td></td><td></td><td></td><td></td><td></td><td></td><td>H</td></tr> </table>																■																	P																		M																		K																		N																		S																		H
■																	P																																																																																																										
																	M																																																																																																										
																	K																																																																																																										
																	N																																																																																																										
																	S																																																																																																										
																	H																																																																																																										

Wendeschneidplatten
Indexable inserts

 N = Anzahl der Schneidkanten N = Number of cutting edges		Schneidstoffsorten Cutting materials Ident No.											Für Fräser For cutter Cat-No.					
		LWP40M	LWNS30M	LWNS10M	LWNS33M	LCP40M	LCPK30M	LCPK10M	LCPK25M	LCPK15M	LCKP10M	LCHK10M		LCH33M	LCN10M	LDN10M		
LMT-Code	l	d	s	d ₁	r													
 N = 2	WPR 8 SF	-	8	2	3	4											EBG R 12...SF	
	WPR 10 SF	-	10	2,5	4	5												
	WPR 12 SF	-	12	2,5	5	6												EBG R 12...SF
	WPR 16 SF	-	16	3	5	8												EBG R 16...SF
	WPR 20 SF	-	20	3	5	10												EBG R 20...SF
	WPR 25 SF	-	25	4	6	12,5												EBG R 25...SF

■ = Hauptanwendung First choice
□ = Nebenanwendung Alternative

Sortenbeschreibung/-bezeichnung und ISO-Code ab Seite 424/477
Description/Designation of grades and ISO-Code starting page 424/477

Alle WPR-, WPV- und WPB-Wendepplatten sind in der Sorte LCN10M (diamantbeschichtet) oder PKD/CBN-bestückt auf Anfrage lieferbar.
All WPR, WPV and WPB inserts are available in grade LCN10M (diamond coated) or PCD/CBN tipped.

Zum Schlichten von Stahl, Stahlguss und gehärteten Stählen bis 65 HRC
For finishing of steel, cast steel and hardened steels up to 65 HRC

											■	□						P
													□					M
													■	■				K
																		N
													□	□				S
													■	■				H

		Schneidstoffsorten Cutting materials											Für Fräser For cutter													
		Ident No.																								
N = Anzahl der Schneidkanten N = Number of cutting edges	LMT-Code	l	d	s	d ₁	r	LWP40M	LCP40M	LWNS30M	LCPK30M	LCHK30M	LWNS10M	LCPK10M	LCKP10M	LCHK10M	LCN10M	LWNS33M	LCH33M	LBHK95M	LDN10M	Cat-No.					
<p>N = 2</p>	WPT A	6	12	4	-	-	6122414					6122418	6122419									EBG T ..				
<p>■ = Hauptanwendung First choice □ = Nebenanwendung Alternative</p> <p>Sortenbeschreibung/-bezeichnung und ISO-Code ab Seite 424/477 Description/Designation of grades and ISO-Code starting page 424/477</p>																										
																							P			
																								M		
																								K		
																								N		
																								S		
																								H		

							Schneidstoffsorten Cutting materials Ident No.										Für Fräser For cutter Cat-No.						
N = Anzahl der Schneidkanten N = Number of cutting edges	LMT-Code	l	d	s	d ₁	r	LWP40M	LWNS30M	LWNS10M	LWNS33M	LCP40M	LCPK30M	LCPK10M	LCPK25M	LCPK15M	LCKP10M		LCHK10M	LCH33M	LCN10M	LDN10M		
 N = 2	WPV 08 CF	9,5	8	2	3	0,6	6122538		6122543		7017875	7014249										EBG V 08	
	WPV 10 CF	11,5	10	2,5	4	0,8	6122598		6122586		6132354	7014303										EBG V 10	
	WPV 12 CF	14	12	2,5	5	1	6122590		6122579		7016130	7014302										EBG V 12	
	WPV 16 CF	16	16	3	5	1,3	6122583		6122572		7016132	7014301										EBG V 16	
	WPV 20 CF	18	20	3	5	1,6	6122576		6122565		7016134	7014300										EBG V 20	
	WPV 25 CF	23,5	25	4	6	2	6122569		6122558		7016136	7016137										EBG V 25	
	WPV 32 CF	28	32	5	8	2,5	6122546		6122550			7016140										EBG V 32	
							■				■	■										P	
												□											M
													■										K
								■															N
																							S
																							H

■ = Hauptanwendung First choice
□ = Nebenanwendung Alternative

Sortenbeschreibung/-bezeichnung und ISO-Code ab Seite 424/477
Description/Designation of grades and ISO-Code starting page 424/477

Alle WPR-, WPV- und WPB-Wendepplatten sind in der Sorte LCN10M (diamantbeschichtet) oder PKD/CBN-bestückt auf Anfrage lieferbar.
All WPR, WPV and WPB inserts are available in grade LCN10M (diamond coated) or PCD/CBN tipped.

							Schneidstoffsorten Cutting materials										Für Fräser For cutter					
							Ident No.															
N = Anzahl der Schneidkanten N = Number of cutting edges	LMT-Code	l	d	s	d ₁	r	LWP40M	LWNS30M	LWNS10M	LWNS33M	LCP40M	LCPK30M	LCPK10M	LCPK25M	LCPK15M	LCKP10M	LCHK10M	LCH33M	LCN10M	LDN10M	Cat-No.	
 N = 2	WPV 08 N	9,5	8	2	3	0,6	6122608		6122594		7016008					7108592					EBG V 08	
	WPV 10 N	11,5	10	2,5	4	0,8	6122682		6122668		7016009					7108596					EBG V 10	
	WPV 12 N	14	12	2,5	5	1	6122672		6122664		7016131					7108601					EBG V 12	
	WPV 16 N	16	16	3	5	1,3	6122650		6122640		7016133					7108604					EBG V 16	
	WPV 20 N	18	20	3	5	1,6	6122644		6122634		7016135					7108605					EBG V 20	
	WPV 25 N	23,5	25	4	6	2	6122638		6122628		7016138					7108607					EBG V 25	
	WPV 32 N	28	32	5	8	2,5	6122614		6122620		7016141					7108608					EBG V 32	
							■				■				■						P	
																□						M
																■						K
								■														N
																						S
																						H

■ = Hauptanwendung First choice
□ = Nebenanwendung Alternative

Sortenbeschreibung/-bezeichnung und ISO-Code ab Seite 424/477
Description/Designation of grades and ISO-Code starting page 424/477

Alle WPR-, WPV- und WPB-Wendepplatten sind in der Sorte LCN10M (diamantbeschichtet) oder PKD/CBN-bestückt auf Anfrage lieferbar.
All WPR, WPV and WPB inserts are available in grade LCN10M (diamond coated) or PCD/CBN tipped.

		Schneidstoffsorten Cutting materials Ident No.											Für Fräser For cutter Cat-No.											
		LMT-Code	l	d	s	d ₁	r	LWP40M	LCP40M	LWNS30M	LCPK30M	LCHK30M		LWNS10M	LCPK10M	LCKP10M	LCHK10M	LCN10M	LWNS33M	LCH33M	LBHK95M	LDN10M		
 N = 2	WRT 25	-	25	4	6	-	6200211						6122402										EBG T 25	
	WRT 32	-	32	5	8	-	6200213						6122387										EBG T 32	
							■	■					□										P	
																								M
														■										K
																								N
																								S
																								H

■ = Hauptanwendung First choice
□ = Nebenanwendung Alternative

Sortenbeschreibung/-bezeichnung und ISO-Code ab Seite 424/477
Description/Designation of grades and ISO-Code starting page 424/477

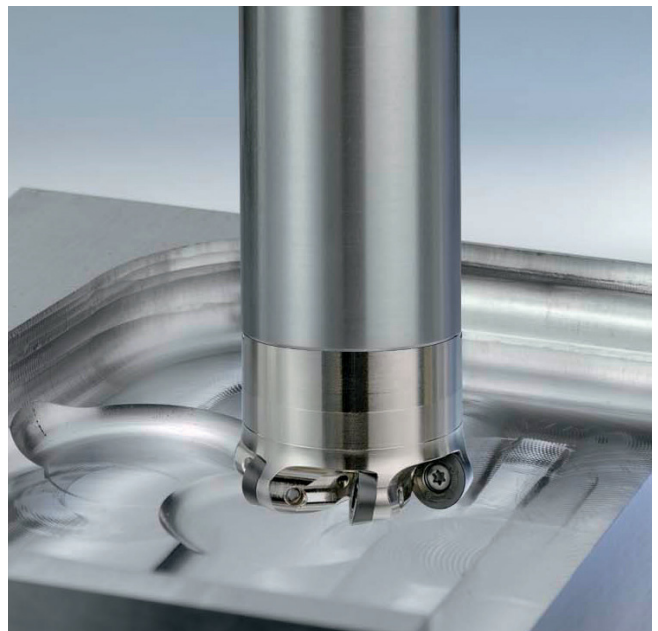

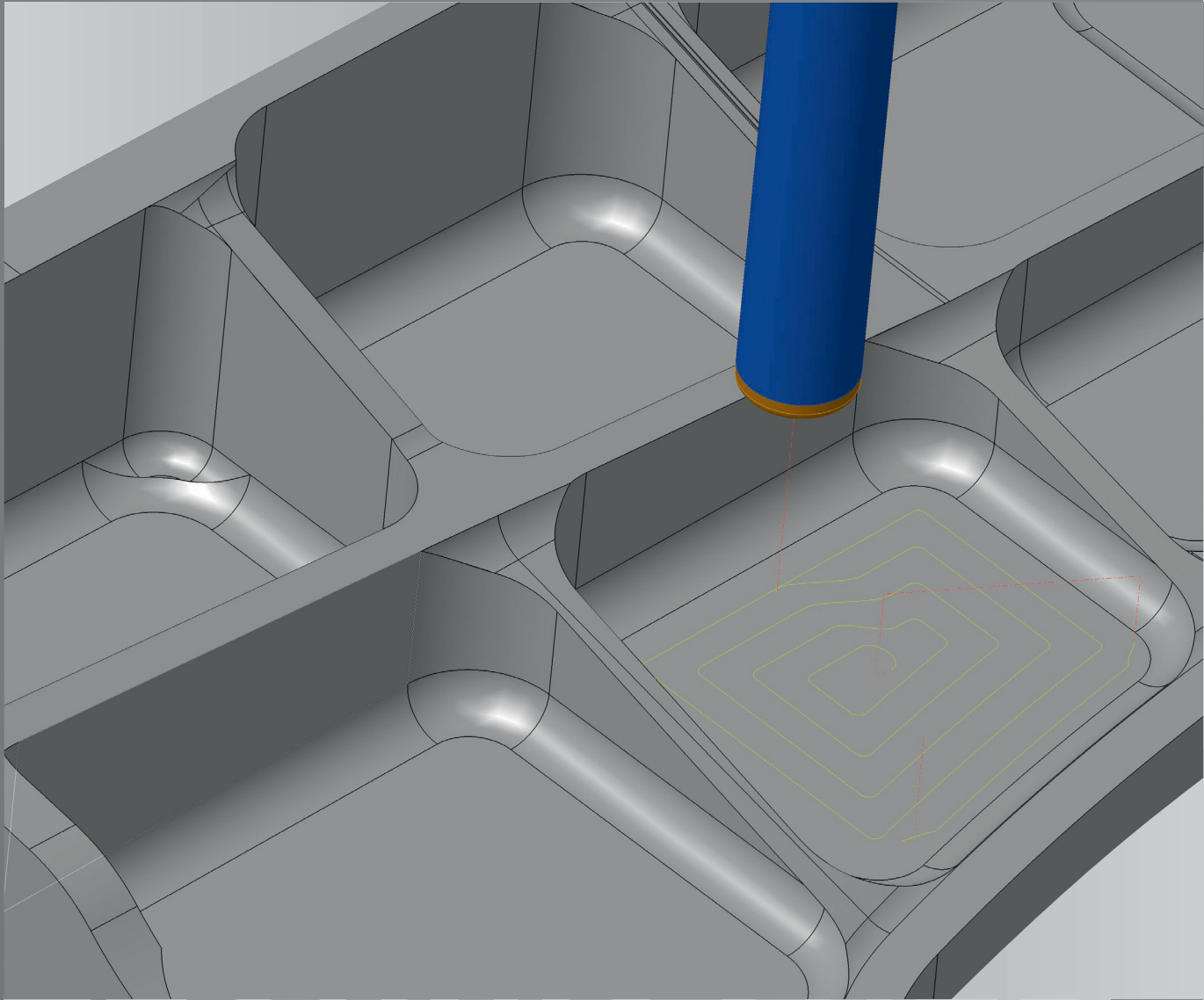

**TECHNISCHER
ANHANG**
TECHNICAL APPENDIX

474	Erklärung LMT-Code Vollhartmetall-Schaftfräser Explanation LMT-Code solid carbide end mills
474	Erklärung LMT-Code Micro HSCline Explanation LMT-Code Micro HSCline
475	Erklärung LMT-Code Trägerwerkzeuge Explanation LMT-Code indexable tool
476	Der LMT Schneidstoffschlüssel The LMT cutting material key
477	LMT-Schneidstoffe LMT cutting materials
484	Vergleichstabelle: Werkstoffe Comparison chart: materials
486	Vergleichstabelle: Härte Comparison chart: hardness
487	Maße, Einheiten und Anwendungsformeln Dimensions, units and application formulas
488	Schnittwertermittlung Calculation of cutting data

489	Diagramme zum effektiven Schnittkreis-Durchmesser Diagrams of effective cutting diameter
490	Effektiver Durchmesser bei Kugelwerkzeugen Effective diameter of ball nose tools
491	Maximale Bearbeitungswerte für ECT/ECZ/FCZ/FCT/FMP45 Kopierfräser Maximum machining data for ECT/ECZ/FCZ/FCT/FMP45 copy cutters
492	Problemlösungen zum Fräsen mit Wendeplatten Trouble shooting for indexable milling
494	Problemlösungen zum Fräsen mit VHM Fräsern Trouble shooting for solid carbide end mills
495	Berechnung des Eingriffswinkels Calculation of approach angle
496	Ersatzteile Spare parts
497	Piktogrammerklärung und -übersicht Pictogram description and overview
500	Katalognummern-Verzeichnis Catalog number index

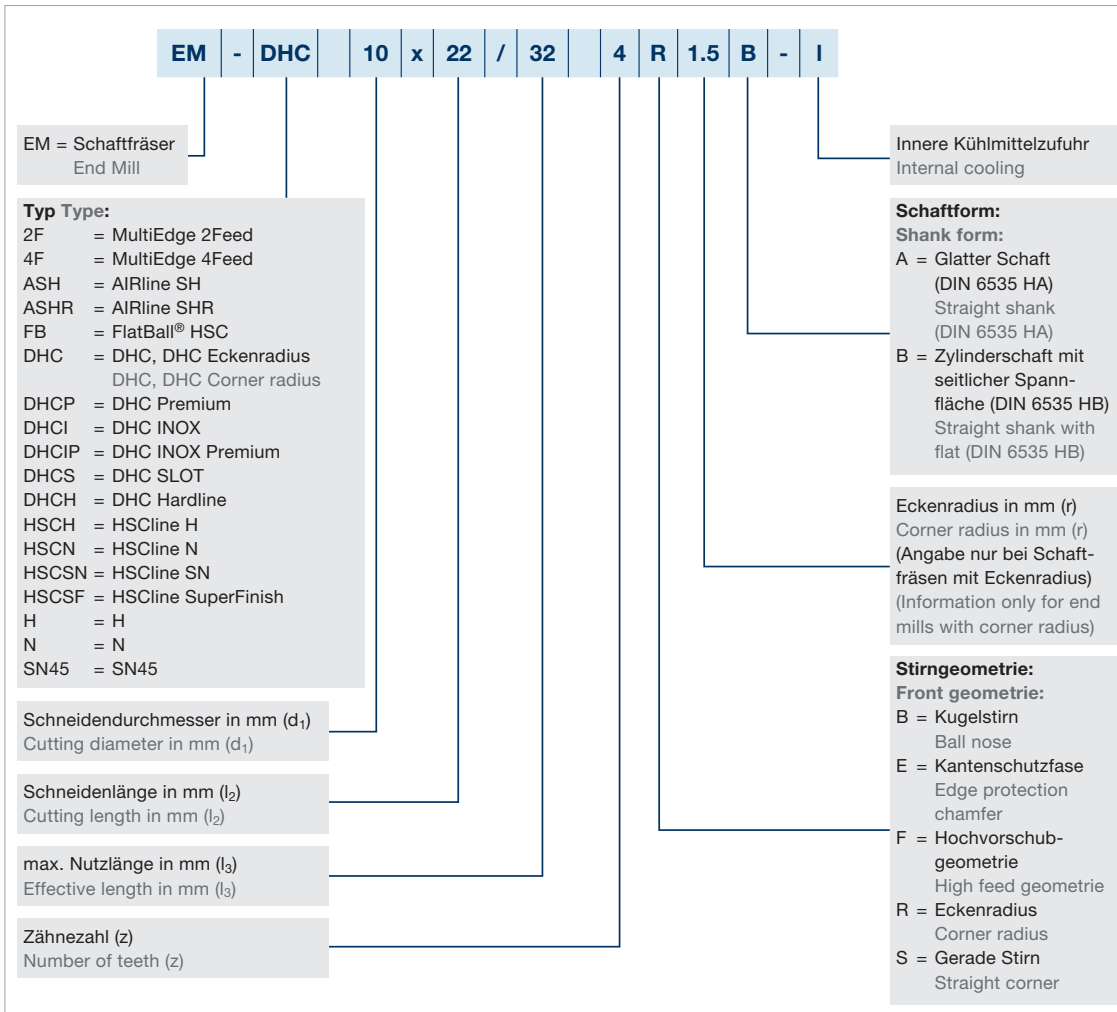

Erklärung LMT-Code Micro HSCline
Explanation LMT-Code Micro HSCline

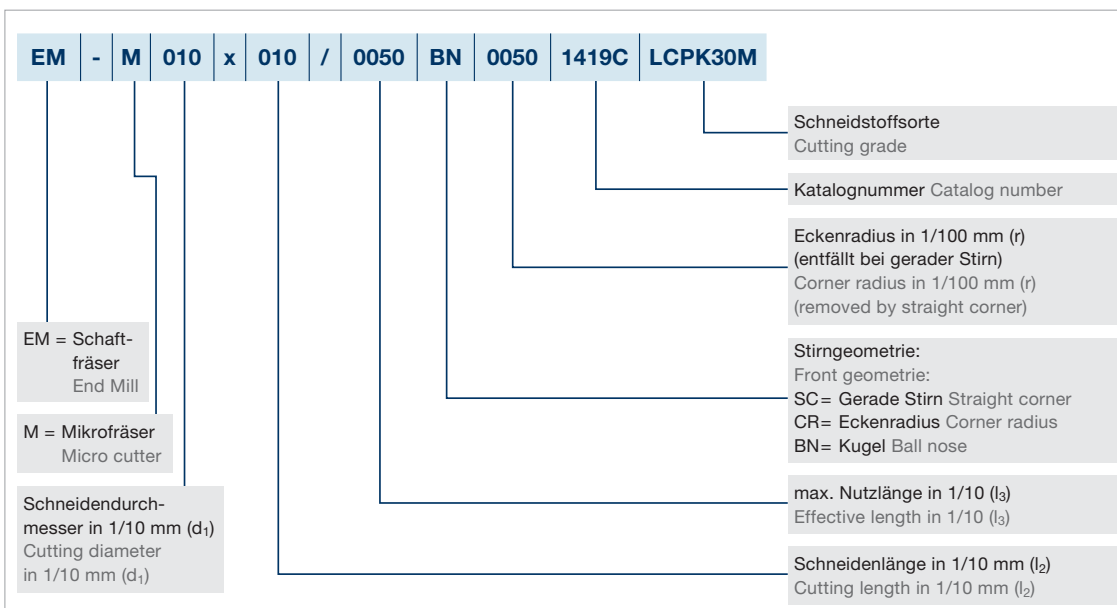

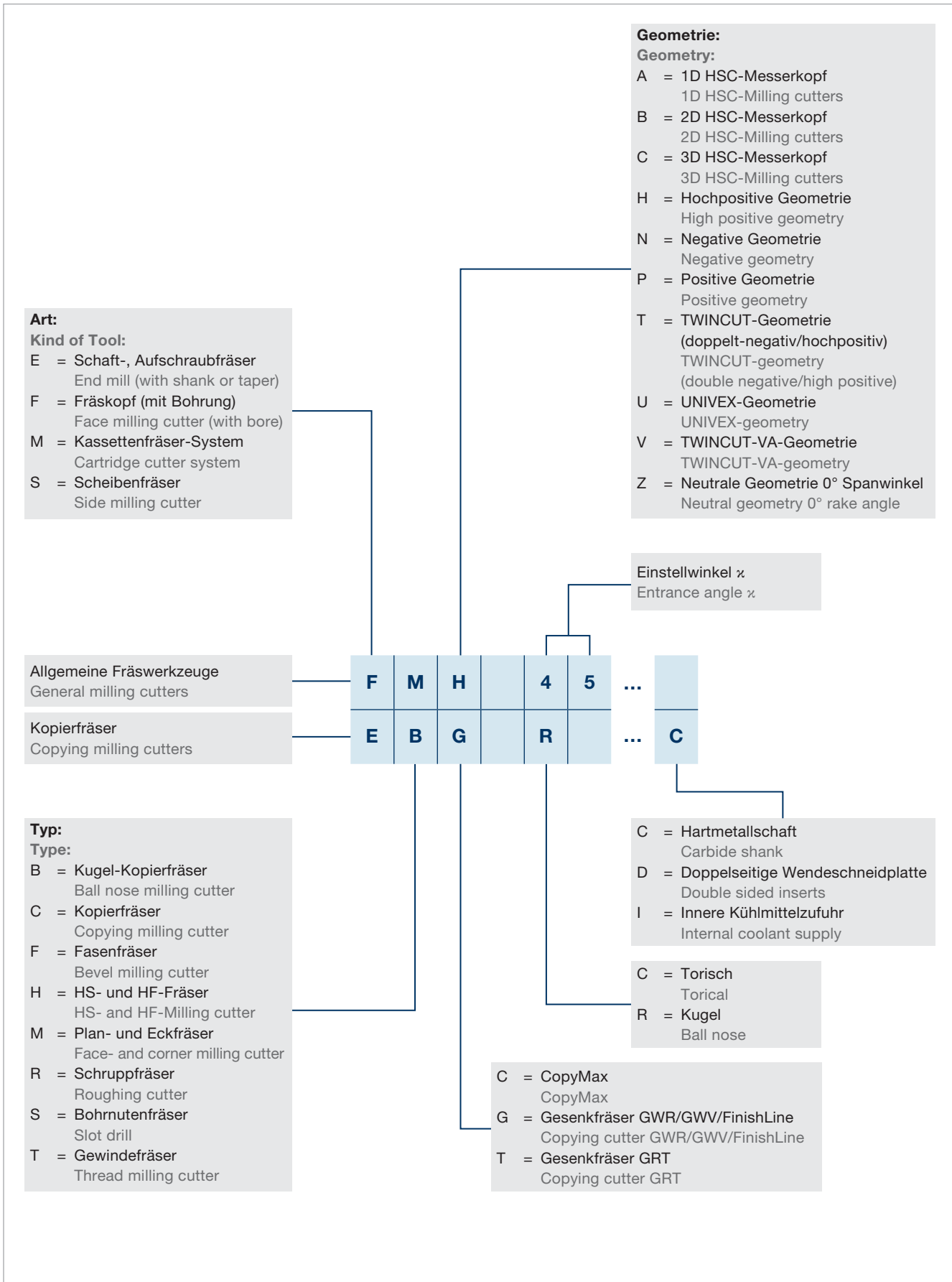

Für Schneidstoff- und Beschichtungssorten hat die LMT einen anwenderbezogenen Sortenschlüssel entwickelt. Hiermit wird es dem Anwender ermöglicht, gemäß seiner spezifischen Applikation immer den richtigen LMT Schneidstoff auszuwählen.

LMT has developed a user-oriented grades index for the new LMT cutting material and coating grades to ensure that users always select the correct LMT cutting material for their applications.

Die Empfehlung basiert auf dem international verwendeten ISO Schlüssel der Werkstückstoffe.

This recommendation is based on the internationally used ISO key for workpiece materials.

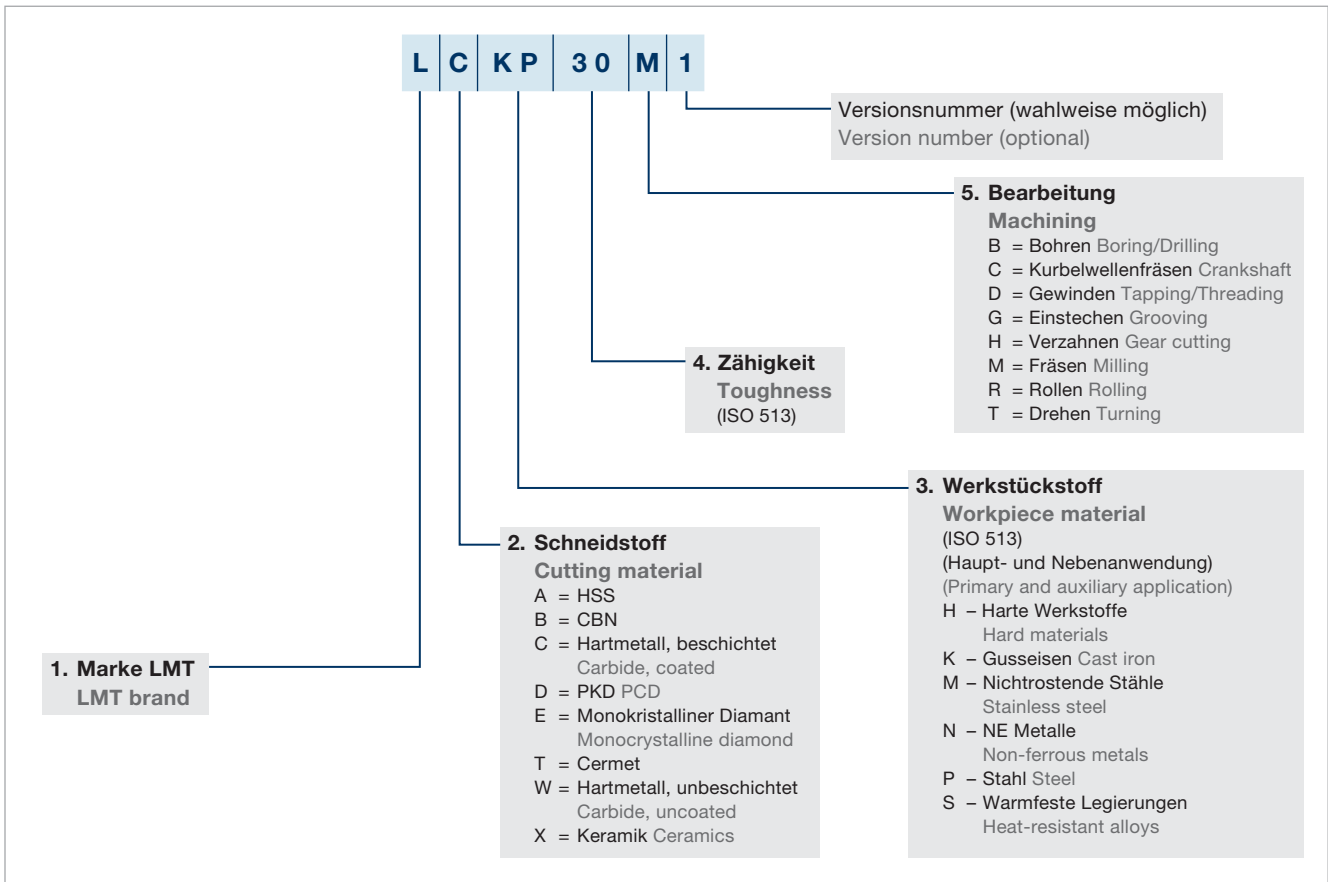

Die bisherigen Sortenbezeichnungen behalten bis auf weiteres ihre Gültigkeit.

The previously used grade designations remain valid until further notice.

<p>Beispiel:</p> <p>LCK10M</p> <p>L – LMT C – Hartmetall, beschichtet K – Gusseisen 10 – Zähigkeit M – Fräsen</p>	<p>Example:</p> <p>LCK10M</p> <p>L – LMT C – Carbide, coated K – Cast iron 10 – Toughness M – Milling</p>
---	---

Schneidstoffe Cutting material grades	Beschreibung	Description
LBHK85M LBHK95M	Kubisches Bornitrid CBN Extrem hochverschleißfeste Fräsorte zur Bearbeitung von gehärteten Werkstoffen > 54 HRC und Grauguss. <ul style="list-style-type: none"> ■ Hohe Schnittgeschwindigkeiten ■ Kleine bis mittlere Spannungstiefen ■ Kleine bis mittlere Zahnvorschübe 	Cubical boron nitride (CBN) Extremely wear resistant milling grade for machining hardened materials with > 54 HRC and cast iron. <ul style="list-style-type: none"> ■ High cutting speeds ■ Low to medium depths of cut ■ Low to medium chip load
LCH05M	HC-K03 PVD-TiAlN ALX beschichtet Extrem verschleißfeste Sorte, speziell geeignet zum Schlichten von Kalt- und Warmarbeitsstahl, geeignet für die Hartbearbeitung und NE-Metalle. <ul style="list-style-type: none"> ■ Hohe Schnittgeschwindigkeit ■ Kleine Spannungsquerschnitte ■ Kleine bis mittlere Zahnvorschübe 	HC-K03 PVD-TiAlN ALX coated Extremely wear-resistant grade, particularly suitable for finishing of cold and hot forming tool steel. Suitable for hard machining. Also suitable for cast iron and non-ferrous metals. <ul style="list-style-type: none"> ■ High cutting speeds ■ Low chip-forming cross-sections ■ Low to medium chip load
LCH33M	HC-K30 Ultrafeinkorn PVD-TiAlN ALX beschichtet Hochverschleißfeste Ultrafeinkorn-Sorte mit hoher Zähigkeit und großer Biegebruchfestigkeit für die Nass- und Trockenbearbeitung von Stahl, Stahlguss, Grauguss und NE-Metallen, geeignet für die Hartbearbeitung. <ul style="list-style-type: none"> ■ Mittlere bis hohe Schnittgeschwindigkeiten ■ Mittlere Spannungstiefen ■ Mittlere Zahnvorschübe 	HC-K30 fine-grain PVD TiAlN ALX coated Highly wear-resistant ultra fine grain grade with high toughness for wet and dry machining of steel, cast steel, cast iron and non-ferrous metals. Suitable also for hard machining. <ul style="list-style-type: none"> ■ Medium to high cutting speeds ■ Medium depths of cut ■ Medium chip load
LCHK10M	HC-K10 Feinkorn PVD-TiAlN ALX beschichtet Hochverschleißfeste Sorte mit hoher Zähigkeit für die Nass- und Trockenbearbeitung von Stahl, Stahlguss, Grauguss und NE-Metallen. Besonders geeignet für die Hartbearbeitung von Werkstoffen > 56 HRC	HC-K10 fine-grain PVD TiAlN ALX coated Highly wear-resistant grade with high toughness for wet and dry machining of steel, cast steel, cast iron and non-ferrous metals. Especially suitable for hard machining of materials > 56 HRC
LCHK20M	HC-K20 PVD-TiAlN/AlCrN beschichtet Spezielle Feinstkorn-Hartmetallsorte besonders geeignet für die Hartbearbeitung bis 65 HRC. Ebenfalls auch gut in der Gussbearbeitung einsetzbar	HC-K20 PVD TiAlN/AlCrN coated Special fine grain carbide grade especially for hard machining up to 65 HRC. Also suitable for machining cast iron
LCHK30M (LC620ZM)	HC-K30 – PVD-ALX beschichtet Hochverschleißfeste AlTiN beschichtet Fräsorte für hohe Schnittgeschwindigkeiten und Trockenbearbeitung geeignet. Besonders für die Bearbeitung von Grauguss, Sphäroguss, hochfesten und abrasiven Werkstoffen geeignet. <ul style="list-style-type: none"> ■ Mittlere Spannungstiefen ■ Mittlere Zahnvorschübe 	HC-K30 – PVD-ALX coated Highly wear resistant AlTiN-coated milling grade suitable for high cutting speeds and dry machining. Particularly well-suited for machining cast iron, spheroidal graphite iron, high-strength and abrasive materials. <ul style="list-style-type: none"> ■ Medium depths of cut ■ Medium chip load
LCHP15M	HC-K15 – PVD TiSiN beschichtet Spezielle Feinstkorn-Hartmetallsorte besonders geeignet für die Hartbearbeitung bis 65 HRC. Ebenfalls gut für die Stahlbearbeitung geeignet	HC-K15 – PVD TiSiN coated Special fine grain solid carbide grade especially for hard machining up to 65 HRC. Also suitable for machining steel.
LCHP20M	HC-K20 – PVD TiAlN beschichtet Spezielle Feinstkorn-Hartmetallsorte besonders geeignet für die Bearbeitung von hochfesten Werkstoffen bis 1600 N/mm ² oder gehärtetem Stahl von 45–55 HRC.	HC-K20 – PVD TiAlN coated Special fine grain solid carbide especially for machining of high strength materials up to 1600 N/mm ² or hardened steel from 45 to 55 HRC.



Schneidstoffe Cutting material grades	Beschreibung	Description
LCK10M	Schneidstoffsorte speziell für die Gussfräsbearbeitung Feinstkorn Hartmetall beschichtet mit der TERAspeed (AlTiN) für die Hochleistungsgussbearbeitung, für hohe Schnittgeschwindigkeiten und für Trockenbearbeitung geeignet	Cutting material grades specifically for cast iron milling Finest grade carbide coated with TERAspeed (AlTiN) for high-performance cast iron machining, high cutting speeds and dry machining
LCK15M	HC-K15 Ausgesuchte Rohstoffe für ein optimiertes K15-Hartmetallsubstrat mit einer extrem harten und verschleißfesten MT-CVD Mehrlagenbeschichtung. Ideal geeignet für die Trockenbearbeitung von Grauguss (GG), Kugelgraphitguss (GGG), Temperguss und legiertem Guss	HC-K15 Specially selected raw materials for an optimum K15-carbide substrate with an extremely hard and wear resistant MT-CVD multilayer coating. Ideal for the dry machining of grey cast iron (GG), nodular cast iron (GGG), malleable cast iron and alloyed cast iron
LCK20M	Hartmetallsorte: K20 CVD-Beschichtung Verschleißfeste Sorte für die Bearbeitung von Grauguss, Kugelgraphitguss und Sphäroguss, geeignet zum Schruppen und Schlichten	Carbide grade: K20 CVD coating Wear-resistant grade for processing cast iron, ductile graphite iron, and spheroidal graphite iron, suitable for roughing and finishing
LCKP10M	HC-K10 PVD-TiAlN beschichtet Hochverschleißfeste beschichtete Fräsorte mit hoher Schneidkantenstabilität zur Feinbearbeitung von legierten und unlegierten Werkzeugstählen, hochfesten Werkstoffen, NE-Metallen und Grauguss mit höheren Schnittgeschwindigkeiten. ■ Kleine bis mittlere Spannungstiefen ■ Kleine bis mittlere Zahnvorschübe	HC-K10 PVD TiAlN coated Highly wear-resistant coated milling grade with high cutting edge stability for fine machining of alloyed and unalloyed tool steels, high-strength materials, non-ferrous metals and cast iron at high cutting speeds. ■ Low to medium depths of cut ■ Low to medium chip load
LCKP20M	HC-P20 – PVD-AlTiCr N beschichtet Verschleißfeste und zähe Mehrbereichssorte mit einer Beschichtung, welche sich durch eine hohe Zähigkeit bei gleichzeitig hoher Härte auszeichnet. Geeignet zum Nass- und Trockenfräsen von Stahl, legierten und unlegierten Werkzeugstählen, Stahlguss und Grauguss. Mittlere Schnittgeschwindigkeiten bei mittleren Zustellungen und mittleren bis hohem Zahnvorschub	Coated with HC-P20 – PVD-AlTiCr N Wear-resistant and tough multi-application grade with a coating which is characterized by high toughness and simultaneously high strength. Suitable for wet and dry milling of steel, alloyed and unalloyed tool steels, cast steel and cast iron. Medium cutting speeds with medium infeeds and medium to high chip load
LCKP25M	HC-K20 – PVD Nanomold Gold beschichtet Sorte speziell für die Gussbearbeitung, aber auch Stahlbearbeitung geeignet mit einer anwendungsangepassten Mehrlagen TiAlN/AlCrN Schicht	HC-K20 – PVD Nanomold Gold coated Grade specially suited for cast processing, but also for steel processing with an application-specific multilayer-TiAlN/AlCrN coating
LCKP28M	HC-P25 (M25) CVD-TiCN Verschleißfestes und zähes Grundsubstrat zum Nass- und Trockenfräsen von Stahl, rostfreien Stählen, Stahlguss und Grauguss. Geeignet für mittlere bis hohe Schnittgeschwindigkeiten bei kleinen bis mittleren Zustellungen und mittleren Zahnvorschub	HC-P25 (M25) CVD-TiCN Wear-resistant and tough base substrate for wet and dry milling of steel, stainless steel, cast steel and cast iron. Suitable for medium to high cutting speeds at low to medium d.o.c. and medium pitch
LCKP30M	HC-K30 TiAlN AL2Plus beschichtet Hochverschleißfeste beschichtete Fräsorte mit hoher Schneidkantenstabilität zur Bearbeitung von legierten und unlegierten Werkzeugstählen, hochfesten Werkstoffen, Grauguss mit mittleren Schnittgeschwindigkeiten. ■ Mittlere Spannungstiefen ■ Mittlere Zahnvorschübe	HC-K30 TiAlN AL2Plus coated Highly wear-resistant milling grade with high cutting edge stability for machining of alloyed and unalloyed tool steels, high-strength materials and cast iron at medium cutting speeds. ■ Medium depths of cut ■ Medium chip loads

Schneidstoffe Cutting material grades	Beschreibung	Description
LCM35M	<p>HC-M35 Nanomold Gold</p> <p>Temperaturstabiler und zäher Schneidstoff für die Schruppbearbeitung von rost- und säurebeständigen Stählen, sowie von legierten und unlegiertem Werkzeugstählen. Durch die besonders nachbehandelte Beschichtung werden insbesondere Werkstoffverklebungen vermieden, wodurch maximale Standzeiten erreicht werden. Eignung für die Nass- und Trockenzerspanung.</p>	<p>Temperature stable and tough cutting material for roughing stainless steel and acid-resistant steel and of alloyed and non-alloyed tool steel. Thanks to the special post-treated coating, material adhesion, in particular, is prevented, allowing maximum tool life to be reached. Suitable for wet and dry chip machining.</p>
LCM40M	<p>HC-P40 – PVD-AL2Plus beschichtet</p> <p>Verschleifefeste Sorte mit hohen Zähigkeitseigenschaften spez. für das Trockenfräsen von hochlegierten, rostfreien und Edelstählen geeignet.</p> <ul style="list-style-type: none"> ■ Mittlere bis hohe Schnittgeschwindigkeit ■ Mittlere bis hohe Spannungsquerschnitte ■ Mittlere bis hohe Zahnvorschübe 	<p>HC-P40 – PVD-AL2Plus coated</p> <p>Wear-resistant grade with high toughness characteristics, particularly well-suited for dry milling high-alloy, stainless and high-grade steels.</p> <ul style="list-style-type: none"> ■ Medium to high cutting speeds ■ Medium to high chip-forming cross sections ■ Medium to high chip load
LCM44M	<p>PVD – Multilagen beschichtete Hartmetallsorte für das Nassfräsen nicht rostender Stähle und hochtemperaturfesten Legierungen.</p> <p>Verbessertes Verschleißverhalten und Verringerung von Ausbrüchen bei mittlerer Schnittgeschwindigkeit für die leichte und mittlere Bearbeitung.</p>	<p>PVD – Type of multi-layer coated carbide grade for wet-milling of stainless steel and high-temperature resistant alloys.</p> <p>Improved wear behaviour and less chipping at medium cutting speed for light and medium processing.</p>
LCM45M	<p>HC-P40 – PVD AITIN</p> <p>Feinstkornsubstrat mit einem hohen Kobaltgehalt und einer extrem feinkörnige nanokristalline AlTiN Schicht. Die Kombination daraus ermöglicht eine hohe Wirtschaftlichkeit beim Trocken- und Nassfräsen von rostfreien und rostbeständigen Stählen, bei niedrigen bis mittleren Schnittgeschwindigkeiten.</p>	<p>HC-P40 – PVD AITIN</p> <p>Ultra-fine grain substrate with high cobalt content combined with a nanocrystalline AlTiN coating. The new grade offers economic efficiency of dry and wet milling of stainless and corrosion-resistant steel grades at low to medium cutting speeds.</p>
LCMS30M	<p>HC-K30 – PVD TiAlN/AlCrN</p> <p>Dieser neue Schneidstoff mit mehrlagiger feinkristalliner PVD Hochleistungsbeschichtung der aktuellen Generation kombiniert die Eigenschaften höchster Ansprüche gegenüber Verschleißreduzierung bei gleichzeitig hoher Temperaturbeständigkeit beim Fräsen in hochwarmfesten Materialien</p>	<p>HC-K30 – PVD TiAlN/AlCrN</p> <p>New generation multilayer finegrain coating which combines best wear resistance as well as high temperature resistance when machining hot working steels.</p>
LCMS35M	<p>Hartmetallsorte: M35</p> <p>CVD-Beschichtung</p> <p>Spezielle Sorte für die Bearbeitung von rostfreien-, hochwarmfesten Stählen und Titan, geeignet für mittlere Schruppoperationen und zum Schlichten</p>	<p>Carbide grade: M35</p> <p>CVD coating</p> <p>Special grade for processing stainless, highly heat-resistant steels and titanium, suitable for medium roughing operations and for finishing</p>
LCN10M	<p>HC-K10 – CVD-diamantbeschichtet</p> <p>Diamant-beschichtetes Hartmetall zur Graphitbearbeitung, geeignet zum Schruppen und Schlichten, einsetzbar zur 3- und 5-Achsen Bearbeitung sowie zur HSC-Bearbeitung</p>	<p>HC-K10 – CVD diamond coated</p> <p>Diamond-coated carbide for graphite machining suitable for roughing and finishing, can be used for 3- and 5 axis as well as for high speed cutting</p>
LCN15M	<p>HC-K15 – CVD-Diamand beschichtet</p> <p>Spezielle CVD-Diamand beschichtete Feinstkorn-Hartmetallsorte besonders geeignet für die Graphitbearbeitung</p>	<p>HC-K15 – CVD Diamond coated</p> <p>Special CVD Diamond coated fine grain carbide grade especially for machining of graphite</p>



Schneidstoffe Cutting material grades	Beschreibung	Description
LCP35M	Hartmetallsorte: P30-P40/M30-M40 PVD-Beschichtung Spezielle Sorte für die Bearbeitung von legierten und unlegierten Stahlsorten, geeignet zum Schruppen und Schlichten	Carbide grade: P30-P40/M30-M40 PVD coating Special grade for processing alloyed and unalloyed steels, suitable for roughing and finishing
LCP40M	HC-P40 PVD-AlCrN beschichtet Hochverschleißfeste Sorte mit hoher Zähigkeit zum Nass- und speziell zum Trockenfräsen von Stahl, Stahlguss und Grauguss. <ul style="list-style-type: none"> ■ Mittlere bis hohe Schnittgeschwindigkeit ■ Mittlere bis hohe Spanungsquerschnitte ■ Mittlere bis hohe Zahnvorschübe 	HC-P40 – PVD-AlCrN coated Highly wear-resistant grade with high toughness for wet milling and dry milling, in particular, steel, cast steel and cast iron. <ul style="list-style-type: none"> ■ Medium to high cutting speeds ■ Medium to high chip-forming cross sections ■ Medium to high chip load
LCP44M	Die Kombination von besonders zähem Hartmetall mit einer temperaturstabilen TERAspeed (AlTiN-CVD)-Beschichtung ist prädestiniert für die Zerspanung unter Einsatz von Kühlschmierstoffen. Aufgrund des Mehrlagenaufbaues der TERAspeed Beschichtung wird die thermisch induzierte Rissentstehung reduziert und das Risswachstum verhindert.	A combination of tough carbide substrate with the temperature resistant coating TERAspeed (AlTiN-CVD) is ideal for wet steel milling operations. The multilayer coating architecture provide the feature to minimized thermal crack initiation and prevent crack growth.
LCPK10M	HC-K10 PVD- AlCrN beschichtet Hochverschleißfeste beschichtete Fräsorte mit hoher Schneidkantenstabilität zur Feinbearbeitung von legierten und unlegierten Werkzeugstählen. Hohe Stabilität und Verschleißfestigkeit gerade bei extrem hoher Temperaturbelastung. Geeignet für die Trocken- und HSC-Bearbeitung bis 54 HRC. <ul style="list-style-type: none"> ■ Kleine bis mittlere Spannungstiefen ■ Kleine bis mittlere Zahnvorschübe 	HC-K10 PVD- AlCrN coated Highly wear-resistant coated milling grade with high cutting edge stability for fine machining alloyed and unalloyed tool steels. High stability and wear-resistance specifically by high temperatures. Suitable for dry machining and high speed cutting up to 54 HRC. <ul style="list-style-type: none"> ■ Low to medium depths of cut ■ Low to medium chip load
LCPK15M	HC-K10/K20 Nanomold Black (TiAlN basiert) Hochverschleißfeste beschichtete Fräsorte mit einer hohen Schneidkantenstabilität, dadurch besonders geeignet für das Schlichten und Semi-Schlichten von legierten und unlegierten Werkzeugstählen, hochfesten Werkstoffen, Gusseisen und gehärtetem Stahl bis 56 HRC. Geeignet für die Trocken-, Nass-, sowie MMS-Zerspanung.	HC-K10/K20 Nanomold Black (TiAlN based) Highly wear resistant, coated milling grade with high cutting edge stability and thus particularly suitable for finishing and semi-finishing alloyed and unalloyed tool steels, high-strength materials, cast iron and hardened steel up to 56 HRC. Suitable for dry, wet and MQL machining.
LCPK25M	HC-K20/K30 Nanomold Black (TiAlN basiert) Verschleißfeste und zugleich zähe, beschichtete Fräsorte mit einer hohen Schneidkantenstabilität, dadurch besonders geeignet für das Schruppen und Semi-Schlichten von legierten und unlegierten Werkzeugstählen, hochfesten Werkstoffen, Gusseisen. Geeignet für die Trocken-, Nass-, sowie MMS-Zerspanung.	HC-K20/K30 Nanomold Black (TiAlN based) Highly wear resistant and tough, coated milling grade with high cutting edge stability and thus particularly suitable for roughing and semi-finishing alloyed and unalloyed tool steels, high-strength materials and cast iron. Suitable for dry, wet and MQL machining.
LCPK30M	HC-K30 Nanomold Gold Hochverschleißfeste Fräsorte mit einer hohen Schneidkantenstabilität. Eignung für das Schruppen und Semi-Schlichten von legierten und unlegierten Werkzeugstählen, hochfesten Werkstoffen und Gusseisen. Besondere Eignung für die Trockenzerspanung.	Wear-resistant milling grade with maximum cutting edge stability. Suitable for roughing and semi-finishing of alloyed and non-alloyed tool steel, high-strength materials, and cast iron. Ideal for dry machining.

Schneidstoffe Cutting material grades	Beschreibung	Description
LCSM20M	HC-K20 – PVD-AlCrN beschichtet Hochverschleißfeste beschichtete Sorte speziell für Titanlegierungen, sowie rostfreie Werkstoffe und Sondermaterialien wie Zirkonium oder Gold.	HC-K20 – PVD-AlCrN coated High wear resistance coated carbide grade especially for super alloys, titan alloys, stainless steel and special materials like Zirconium or Gold.
LCS40M	HC-M40 Nanomold Red Äußerst zäher Schneidstoff für die Zerspanung von Titan und Inconel. Durch die besonders nachbehandelte Beschichtung werden insbesondere Werkstoffverklebungen vermieden, wodurch maximale Standzeiten erreicht werden. Eignung für die Nass- und Trockenzerspanung.	Extraordinarily tough cutting material for roughing of titanium and Inconel. Thanks to the special post-treated coating, material adhesion, in particular, is prevented, allowing maximum tool life to be reached. Suitable for wet and dry chip machining.
LDN10M	Polykristalliner Diamant PKD Hochverschleißfeste unbeschichtete Fräsorte zur Bearbeitung von Aluminium, Bronze, NE Metallen, Faserverbundwerkstoffe, Kunststoffe, bedingt Keramik und Hartmetalle (weich, vorm Sintern) mit hohen Schnittgeschwindigkeiten. ■ Kleine bis mittlere Spannungstiefen ■ Niedrige bis mittlere Zahnvorschübe	Polycrystalline diamond (PCD) Highly wear-resistant uncoated milling grade for machining of aluminium, bronze, non-ferrous metals, fibre-reinforced composite materials, plastics, certain ceramics and carbides (soft, prior to sintering) at high cutting speeds. ■ Low to medium depths of cut ■ Low to medium chip load
LWNP30M	HC-K30 – unbeschichtet Verschleißfeste Feinstkorn-Hartmetallsorte mit hoher Schneidkantenschärfe besonders für die Bearbeitung von Nichteisenmetallen, wie Aluminium geeignet.	HC-K30 uncoated Wear resistance fine grain carbide grade with a high edge sharpness especially for non-iron metals, like aluminium.
LWNS10M	HW-K10 Feinkorn unbeschichtet Hochverschleißfeste Fräsorte zur Bearbeitung von Grauguss, Al-Legierung und Nichteisenmetallen mit mittlerer bis höheren Schnittgeschwindigkeiten auch unter ungünstigen Betriebsbedingungen.	HW-K10 micro-grain uncoated Milling grade with high wear resistance for machining of grey cast iron, aluminium alloys, and non-ferrous metals at medium to higher cutting speeds, even under unfavourable machining conditions.
LWNS30M	HC-K30 unbeschichtet Hochverschleißfeste Fräsorte mit hoher Schneidkantestabilität zur Bearbeitung von Al-Legierungen, Titan und Nichteisenmetalle mit hohen Schnittgeschwindigkeiten. ■ Mittlere Spannungstiefen ■ Mittlere Zahnvorschübe	HC-K30 uncoated Milling grade with high wear resistance and high cutting edge stability for machining of aluminium alloys, titan and non-ferrous metals with high cutting speeds. ■ Medium depths of cut ■ Medium chip load
LWNS33M	HC-K30 Ultrafeinkorn unbeschichtet Hochverschleißfeste Ultrafeinkorn-Sorte für die Nass- und Trockenbearbeitung von Al-Legierungen, Titan und Nichteisenmetalle. Bei günstigen Bedingungen ist eine Bearbeitung mit sehr hohen Schnittgeschwindigkeiten möglich. ■ Mittlere Spannungstiefen ■ Niedrige bis mittlere Zahnvorschübe	HC-K30 Ultra Micrograin uncoated Highly wear resistant ultra micrograin grade for wet and dry machining of Al-alloys, titanium and non-ferrous materials. Under consistent and rigid conditions, high cutting speeds are possible. ■ Medium depth of cut ■ Low to medium feed per tooth
LWP40M (LW240)	HW-P40 unbeschichtet Zäheste unbeschichtete Hartmetall-Sorte zur mittleren bis schweren Fräsbearbeitung von Stahl und Stahlguss. ■ Niedrige bis mittlere Schnittgeschwindigkeit ■ Mittlere bis hohe Spannungsquerschnitte ■ Zum Nass- und Trockenfräsen	HW-P40 uncoated Extra-tough uncoated carbide grade for medium to heavy milling of steel and cast steel. ■ Low to medium cutting speeds ■ Medium to high chip ■ For wet and dry milling



Schneidstoffe Cutting material grades	Beschreibung	Description
LC225T	HC-P25 PVD-TiAlN AL2Plus beschichtet Hochverschleißfeste Mehrbereichssorte mit guter Zähigkeit zum Nass- und speziell zum Trockenfräsen von Stahl, Stahlguss und Grauguss. <ul style="list-style-type: none"> ■ Sehr hohe Schnittgeschwindigkeiten ■ Kleine bis mittlere Spannungstiefe ■ kleine bis mittlere Zahnvorschübe 	HC-P25 PVD TiAlN AL2Plus coated Highly wear-resistant multiple-application grade with high toughness for wet and dry milling of steel, cast steel and cast iron. <ul style="list-style-type: none"> ■ High cutting speeds ■ Low to medium depths of cut ■ Low to medium chip load
LC230E	HC-P30/M30 Universelle Stahlfräsorte. Hohe Bearbeitungssicherheit auf einem breiten Stahlwerkstoffspektrum wird durch das besonders zähe Hartmetallsubstrat garantiert. Eine moderne MT-CVD Nanolock Mehrlagen – Al ₂ O ₃ – Beschichtung bietet wirtschaftliche Trockenbearbeitung bei hohen Schnittgeschwindigkeiten	HC-P30/M30 The very tough carbide substrate guarantees this universal steel milling grade's high machining security for a wide range of steel material. A modern MT-CVD multilayer Al ₂ O ₃ – coating ensures dry machining with Nanolock high cutting speed
LC230F	Universelle Stahlfräsorte. Hohe Bearbeitungssicherheit auf einem breiten Stahlwerkstoffspektrum wird durch das besonders zähe Hartmetallsubstrat garantiert. Eine moderne MT-CVD Mehrlagen – Al ₂ O ₃ – Beschichtung bietet wirtschaftliche Trockenbearbeitung. Durch die TiN-Deckschicht ist auch Nassbearbeitung möglich	The very tough carbide substrate guarantees this universal steel milling grade's high machining security for a wide range of steel material. A modern MT-CVD multilayer Al ₂ O ₃ – coating ensures dry machining. An outer TiN layer makes wet machining also possible
LC235T	HC-P35 (M35) Nanotop PVD AlTiN Gradientenschicht-Hartmetallsorte mit hoher Zähigkeit zum Fräsen von vor allem Werkzeugstählen. Besonders gut geeignet zum Trockenfräsen bei niedrigen bis mittleren Schnittgeschwindigkeiten für Schruppbearbeitung	HC-P35 (M35) Very tough Nanotop PVD AlTiN gradient-coating-carbide grade especially for milling tool steels. Ideal for dry milling at low to medium cutting speeds for roughing
LC280QN	Hervorragend geeignet für hohe Vorschübe. Eine Kombination von besonders zähem Hartmetallsubstrat mit einer 2-fach PVD-Beschichtung kennzeichnet bereits optisch die hervorragende Eignung dieser Wendeschneidplatten zum Schruppen. Die Wendeschneidplatten sind vollständig mit AL6 beschichtet und besitzen zusätzlich am Umfang eine TiN-Schicht zur besseren Verschleißerkennung	Eminently suited for high feed rates. A combination of tough carbide substrate with a double PVD coating makes it obvious that these indexable inserts are ideal for roughing. The inserts are completely coated with AL6 and have an additional TiN-layer at circumference which allows to observe wear easier
LC444W	HC-M40 Extrem zähes, relativ feinkörniges Hartmetallsubstrat mit dünner, glatter und zäher PVD-Mehrlagenschicht. Ideale Sorte zum Fräsen von austenitisch rostfreien Stählen mit niedrigen bis mittleren Schnittgeschwindigkeiten und Nassbearbeitung.	HC-M40 Extremely tough, relatively fine-grained carbide substrate with thin, smooth and tough PVD-multilayer coating. Ideal grade for milling austenitic stainless steels at low to medium cutting speeds and wet machining
LCH05M	HC-K03 PVD-TiAlN ALX beschichtet Extrem verschleißfeste Sorte, speziell geeignet zum Schlichten von Kalt- und Warmarbeitsstahl, geeignet für die Hartbearbeitung und NE-Metalle. <ul style="list-style-type: none"> ■ Hohe Schnittgeschwindigkeit ■ Kleine Spanungsquerschnitte ■ Kleine bis mittlere Zahnvorschübe 	HC-K03 PVD-TiAlN ALX coated Extremely wear-resistant grade, particularly suitable for finishing of cold and hot forming tool steel. Suitable for hard machining. Also suitable for cast iron and non-ferrous metals. <ul style="list-style-type: none"> ■ High cutting speeds ■ Low chip-forming cross-sections ■ Low to medium chip load
LC620A	HC-K20 – CVD-diamantbeschichtetes Hartmetall zur Graphitbearbeitung, geeignet zum Schruppen und Schlicht mit erhöhten Zähigkeitsanforderung an die Werkzeuge.	HC-K20 – CVD diamond-coated hard metal for graphite machining, suitable for roughing and finishing with high toughness requirement for tools.

Schneidstoffe Cutting material grades	Beschreibung	Description
LC620Q	<p>HC-K20 – PVD-Al6 beschichtet</p> <p>Zähe, aber sehr verschleißbeständige Fräsorte für die Bearbeitung von unlegierten, niedrig- und hochlegierten Stählen. Hohe Stabilität und Verschleißfestigkeit durch die PVD-AlCrN Beschichtung, gerade in der Trockenbearbeitung.</p> <ul style="list-style-type: none"> ■ Mittlere bis hohe Schnittgeschwindigkeiten ■ Mittlere Spannungstiefen, mittlere Zahnvorschübe 	<p>HC-K20 – PVD-Al6 coated</p> <p>Tough yet very wear-resistant milling grade for machining unalloyed, low-alloy and high-alloy steels. High stability and wear resistance due to PVD-AlCrN coating, even with dry machining.</p> <ul style="list-style-type: none"> ■ Medium to high cutting speeds ■ Medium depths of cut, medium chip load
LC620T	<p>HC-K20 Feinkorn PVD-TiAlN AL2Plus beschichtet</p> <p>Hochverschleißfeste Sorte mit guter Zähigkeit für die Nass- und Trockenbearbeitung von Stahl, Stahlguss, Grauguss und NE-Metallen, bedingt geeignet für die Hartbearbeitung.</p> <ul style="list-style-type: none"> ■ Mittlere bis hohe Schnittgeschwindigkeiten ■ Mittlere Spannungstiefen, mittlere Zahnvorschübe 	<p>HC-K20 fine-grain PVD TiAlN AL2Plus coated</p> <p>Highly wear-resistant grade with high toughness for wet and dry machining of steel, cast steel, cast iron and non-ferrous metals. Suitable also for hard machining.</p> <ul style="list-style-type: none"> ■ Medium to high cutting speeds ■ Medium depths of cut, medium tooth feeds
LW225	<p>HW-P25 unbeschichtet</p> <p>Verschleißfeste, unbeschichtete Mehrbereichsorte mit guter Zähigkeit zum Nass- und Trockenfräsen von legierten Werkstoffen (Guss und zum Teil auch GGG).</p> <ul style="list-style-type: none"> ■ Moderate Schnittgeschwindigkeiten. ■ Kleine bis mittlere Spannungstiefe ■ Kleine bis mittlere Zahnvorschübe 	<p>HW-P25 uncoated</p> <p>Wear-resistant, uncoated multiple-application material with high strength, for wet and dry milling of alloyed materials (cast iron, in some cases also nodular cast iron).</p> <ul style="list-style-type: none"> ■ Moderate cutting speeds ■ Low to medium depths of cut ■ Low to medium chip load

Vergleichstabelle: Werkstoffe
Comparison chart: materials

	Werkstoff	Material	Werkstoff-Nr. Material No.	DIN Bezeichnung Alt DIN Description Old	R_m/UTS (N/mm²)	DIN Bezeichnung Neu DIN Description New
P	Unlegierter Baustahl + Automatenstahl	Plain carbon steel + free cutting steel	1.0570	St52-3	-700	S355J2G3
			1.1730	C45	-800	C45U
			1.0715	9SMn28	-700	11SMn30
			1.1191 1.7219	Ck45 26CrMo4	500-950	C45E 26CrMo4-2
	Vergütungsstahl, mittelfest	Heat-treatment steel, medium strength	1.7225	42CrMo4	500-950	42CrMo4
	Stahlguss	Cast steel	1.8159	51CrV4		51CrV4
	Einsatzstahl	Case hardening steel	1.0416	GS40	-950	GS40
	Rost- und säurebe- ständiger Stahl, ferritisch, martensitisch	Stainless steel, ferritic, martensitic	1.7131	16MnCr5	-950	16MnCr5
			1.4006	X10Cr13	500-950	X12Cr13
			1.4104 1.4122	X12CrMoS17 X35CrMo17		X14CrMoS17 X39CrMo17-1
	Vergütungsstahl, hochfest	Heat-treatment steel, high strength	1.7225	42CrMo4	950-1400	42CrMo4
	Nitrierstahl, vergütet	Nitriding steel, heat treated	1.6580	30CrNiMo8		30CrNiMo8
			1.8504	34CrAl6	950-1400	34CrAl6
	Werkzeugstahl	Tool steel	1.2344	X40CrMoV5.1	-900	X40CrMoV5-1
			1.2343	X38CrMoV5 1	950-1400	X37CrMoV5-1
			1.2379	X155CrVMo12 1	-950	X153CrMoV12-1
			1.2358	60CrMoV18-5	850-1000	60CrMoV18-5
1.2080			X210Cr12	950-1400	X210Cr12	
1.2714			55NiCrMoV7	1100-1350	55NiCrMoV7	
1.2311			40CrMnMo7	-1100	40CrMnMo7	
1.2312			40CrMnNiMoS8.6	-1150	40CrMnNiMoS8-6	
1.2316 1.2738			X38CrMo16 45CrMnNiMo8.6.4	-1100 950-1150	X38CrMo16 45CrMnNiMo8-6-4	
M	Rost- und säurebe- ständiger Stahl, austenitisch	Stainless steel, austenitic	1.4301	X2CrNiMo17-12-2	500-950	X5CrNiMo18-10
			1.4404	X6CrNiMoTi17-12-2		X2CrNiMo17-12-2
			1.4571	X10CrNiMoTi18		X10CrNiMoTi18
	Rost- und säurebe- ständiger Stahl, martensitisch aushärtbar	Stainless steel, martensitic steel	1.2709	X3NiCoMoTi18-9-5	800-1000	X3NiCoMoTi18-9-5
		1.4542	X5CrNiCuNb16-4		X5CrNiCuNb16-4	
		1.4568	X7CrNiAl17-7		X7CrNiAl17-7	
K	Grauguss	Grey cast iron	0.6025	GG25	100-400 (120-260 HB)	EN-GJL-250
	Legierter Grauguss	Alloyed grey cast iron	0.6678	GGL-NiCr35 2	150-250 (160-230 HB)	EN-GJLA-XNiCr35-2
	Sphäroguss	Nodular cast iron	0.7060 0.7070	GGG60 GGG70L	400-800 (120-310 HB)	EN-GJS-600-3 EN-GJS-700-2U
	Temperguss	Malleable cast iron	0.8155	GTS55	350-700 (150-280 HB)	EN-GJMB-550-4
N	Aluminium-Legierungen, kurzspanend	Aluminium alloys, short chipping	3.2581	G-AlSi12	-400	G-IGK-AlSi12
	Aluminium-Legierungen, langspanend	Aluminium alloys, long chipping	3.3535	AlMg3	-550	AlMg3
	Kupfer-Legierungen, kurzspanend	Copper alloys, short chipping	3.4365	AlZnMgCu1,5		AlZnMgCu1,5
	Kupfer-Legierungen, langspanend	Copper alloys, long chipping	2.0402	MS58	-500	CuZn40Pb2
	Thermoplaste	Thermoplastics	2.0320 2.0975	MS63 CuAl10Ni	300-500	CuZn37 CuAl10Fe5Ni5-C
	Duroplaste	Duroplastics		PVC	40-70	PVC
	Graphit	Graphite		Bakelit, Melamin	20-40	Bakelit, Melamin
S	Titan-Legierungen, mittelfest	Titanium alloys, medium strength	3.7115 3.7164	TiAl5Sn2,5 TiAl6V4	-950	TiAl5Sn2-5 TiAl6V4
	Titan-Legierungen, hochfest	Titanium alloys, high strength	3.7174	TiAl6Sn2	900-1400	TiAl6V6Sn2
	Nickelbasis-Legierungen, mittelfest	Nickel based alloys, medium strength	2.4670	NiCr12Al6MoNb	-950	NiCr12Al6MoNb
	Nickelbasis-Legierungen, hochwarmfest	Heat resistant nickel based alloys, high strength	2.4668	NiCr19Fe19NbMo	900-1400	Inconel 718 NiCr19Fe19Nb5Mo3
H	Hartguss	Chilled cast iron		Ni-hard, Ampco	300-600 HB	Ni-hard, Ampco
	Gehärteter Stahl	Hardened steel			45-52 HRC	
					53-59 HRC	
					60-65 HRC	

Spez. Schnittkraft Specific cutting force kc 1.1 (N/mm ²)	Schnittkraft-Exponent Cutting Force exponent m _c	Großbritannien Great Britain		Frankreich France	Italien Italy	Schweden Sweden	Spanien France	Japan Japan	USA USA	Russland Russia	Leistungs-faktor Efficiency factor LF = $\frac{\text{cm}^3}{\text{min} \cdot \text{kW}}$	
		BS	EN	AFNOR	UNI	SS	UNE	JIS	AISI/SAE	GOST		
1700	0,24	4360-50 B	EN43B	E 36-3; E 36-4 Y3 42	Fe 510 B; C; D C45	2132 1672		F.114	SM 50 YA S45C	1045	17 GS	24
	0,24	230 M 07	1A	S 250	CF 9 SMn 28	1912		F.2111	SUM 22	1213		22
	0,24	080 M46		XC 45	C 45	1672		C45K	S 45 C	1045	45	20
	0,24	708 M 40 735 A 50	19A 47	42 CD 4 50 CV4	42 CrMo 4 51 CrV 4	2244 2230		42CrMo4 50CrV4	SCM 440 (H) SUP 10	4242; 4140 6150	G 41400 50ChGFA	18
	0,24											18
	0,24	S27 M 17		16 MC 4	16 MnCr 5	2511		16MnCr5	SCR 415	5115	18ChG	18
	0,24	410 S 21 441S29	56A	Z 12 C 13 Z 12 CF17	X 12 Cr 13 X 10 CrS 17	2302 2383		F.3401 F.3117	SUS 410 SUS 430 F	410; CA-15 430 F	12Ch13	16
	0,24	708 M 40	19A	42 CD 4	42 CrMo 4	2244		42CrMo4	SCM 440 (H)	4242; 4140	G 41400	16
2000	0,24	BH13		Z40CFV5	X40CrMoV511KU	2242		F.5318	SKD61	H13		16
2000	0,24	BH11		Z38CDV5	X37CrMoV51KU	X37CrMoV5-1 2310		F.5317	SKD6	H11	4Ch5MFS	14
2000		BD2		Z160CDV12	X155CrVMo121KU			F.5211	SKD11	D2		
2000		BD3		Z200Cr12	X210Cr13KU	2710		F.5212	SKD1	D3		
2000 1900 2000 1900		P20 P20+S P20+Ni		40CMD8 40CMD8+S Z35CD17 40CMND8	35CrMo8KU X38CrMo161KU	2541 2541		F.5263 X210CrW12 F.5267	SKT3 SKT3+S SUS42J2+Mo SKT3+Ni	P20 P20+S 422 P20+Ni		
1900	0,2	304 S 15 416 S 11 320S31	58E 58	Z 6 CN 18.09 Z 2 CND 17.12 Z 6 CNT 17.12	X 5 CrNi 18 10 X 2 CrNiMo 17 12 X6CrNiTi811	2332; 2333 2348 2350		F.314 F3535-X6CrNiMo- Ti17122	SUS 304 SUS 316 L SUS 347	304; 304 H 316 L 316 Ti	08Ch18N10 10Ch17N13M2T	18
	2000	0,2		Z2NKD18-09 Z 7 CNU 17-04 Z8CNA17-07	NiCrMo X2CrNiMo1712 (1.4568)				SCS 24; SUS 630	630 17-7PH		18
1225	0,25	Grade 260		FT25D	G25	125		FG25	FC250	No35B		30
	0,22											22
	1100	0,28	SNG 600/3 SNG 700/2	FGS 700-2	FGS 600-3 FGS 700-2	GS 600-3 GS 700-2	07 32-03 07 37-01	FGE 60-2 FGS 70-2	FCD600 FCD700	80-55-06 100-70-03		24
1050	0,28	P 510/4		MP50-5	GMN55	08 54					24	
500	0,25	LM 6		A-S13	4514	4261		L-2520	AC3A	A413.0		55
	0,25	A-G3C A-Z5GU		NS DTD5074						5754 7075		60
	0,2	CZ122		CuZn39Pb2	P-CuZn3940Pb2					C37700		35
	0,2	AB2		CuAl11Ni5Fe	G-CuAl1 1Fe4Ni4					B-148-52		50
	0,15											70
	0,15									Phenolic		35
1450	0,23	TA10-13 TA28		T-A6V				Ti-P63		AMSR5640 4911		20
1450	0,23											16
	0,23											18
	0,23	HR 8		NC 19 FeNb	Inconel 718					N07718		15
2900	0,22											
3100												
3300												

Zugfestigkeit R _m Tensile strength R _m N/mm ²	Vickers- härte Vickers hardness HV	Brinell- härte Brinell hardness HB	Rockwell- härte Rockwell hardness HRC
255	80	76	
270	85	80,7	
285	90	85,5	
305	95	90,2	
320	100	95	
335	105	99,8	
350	110	105	
370	115	109	
385	120	114	
400	125	119	
415	130	124	
430	135	128	
450	140	133	
465	145	138	
480	150	143	
495	155	147	
510	160	152	
530	165	156	
545	170	162	
560	175	166	
575	180	171	
595	185	176	
610	190	181	
625	195	185	
640	200	190	
660	205	195	
675	210	199	
690	215	204	
705	220	209	
720	225	214	
740	230	219	
755	235	223	
770	240	228	20,3
785	245	233	21,3
800	250	238	22,2
820	255	242	23,1
835	260	247	24
850	265	252	24,8
865	270	257	25,6
880	275	261	26,4
900	280	266	27,1
915	285	271	27,8
930	290	276	28,5
950	295	280	29,2
965	300	285	29,8
995	310	295	31
1030	320	304	32,2
1060	330	314	33,3
1095	340	323	34,4

Zugfestigkeit R _m Tensile strength R _m N/mm ²	Vickers- härte Vickers hardness HV	Brinell- härte Brinell hardness HB	Rockwell- härte Rockwell hardness HRC
1125	350	333	35,5
1155	360	342	36,6
1190	370	352	37,7
1220	380	361	38,8
1255	390	371	39,8
1290	400	380	40,8
1320	410	390	41,8
1350	420	399	42,7
1385	430	409	43,6
1420	440	418	44,5
1455	450	428	45,3
1485	460	437	46,1
1520	470	447	46,9
1555	480	(456)	47,7
1595	490	(466)	48,4
1630	500	(475)	49,1
1665	510	(485)	49,8
1700	520	(494)	50,5
1740	530	(504)	51,1
1775	540	(513)	51,7
1810	550	(523)	52,3
1845	560	(532)	53,0
1880	570	(542)	53,6
1920	580	(551)	54,1
1955	590	(561)	54,7
1995	600	(570)	55,2
2030	610	(580)	55,7
2070	620	(589)	56,3
2105	630	(599)	56,8
2145	640	(608)	57,3
2180	650	(618)	57,8
	660		58,3
	670		58,8
	680		59,2
	690		59,7
	700		60,1
	720		61
	740		61,8
	760		62,5
	780		63,3
	800		64
	820		64,7
	840		65,3
	860		65,9
	880		66,4
	900		67
	920		67,5
	940		68

Zugfestigkeit Tensile strength	R _m	N/mm ²
Vickershärte Vickers hardness	HV	Diamantpyramide 136°, Prüfkraft F ≥ 98 N Diamond pyramid 136°, Test force F ≥ 98 N
Brinellhärte Brinell hardness Kalkuliert mit calculated from: HB = 0,95 × HV	HB	0,102 × F/D ² = 30 N/mm ² F = Prüfkraft in N, D = Kegeldurchmesser in mm F = Test force in N, D = Ball diameter in mm
Härte Rockwell C Hardness Rockwell C	HRC	Diamantkegel 120°, Gesamtprüfkraft 1471 ± 9 N Diamond cone 120°, Total test force 1471 ± 9 N

<p>a_p = Spanungstiefe in mm Depths of cut in mm</p> <p>a_e = Spanungsbreite in mm Width of cut in mm</p> <p>l = Bearbeitete Länge in mm Machined length in mm</p> <p>h_m = Mittenspanndicke in mm Mean chip thickness</p> <p>v_c = Schnittgeschwindigkeit in m/mm Cutting speed in m/mm</p> <p>f_z = Vorschub pro Zahn in mm Feed per tooth in mm</p> <p>d_1 = Äußerer Werkzeugdurchmesser Outside tool diameter</p> <p>S_d = Effektiver Durchmesser, Schnittkreisdurchmesser in mm Effective diameter with different inserts and at specified cut depth in mm</p> <p>d = Durchmesser der Platte in mm Insert diameter in mm</p> <p>z = Anzahl der Schneiden am Werkzeug Number of tool cutting edges</p> <p>k = Einstellwinkel Lead angle</p> <p>w_s = Eingriffswinkel Approach angle</p> <p>b_r = Zeilensprung Horizontal skip</p> <p>R_{th} = Rauhtiefe Roughness</p> <p>M_c = Spindeldrehmoment in Nm Spindle torque</p> <p>f_n = Vorschub pro Umdrehung Feed per revolution</p> <p>k_c = Spez. Schnittkraft in N/mm² Cutting force in N/mm²</p> <p>P = benötigte Maschinenleistung required machine power</p> <p>LF = Leistungsfaktor Efficiency factor</p>	<p>Umdrehungen pro Minute n [U/min] Revolutions per minute n [rpm]</p> $n = \frac{v_c \cdot 1000}{\pi \cdot d_e}$	<p>Mittlere Spanndicke h_m [mm] Mean chip thickness h_m [mm]</p> $h_m = f_z \cdot \sqrt{\frac{a_e}{d_e}}$ <p>gültig nur bis $\frac{a_e}{d_e} < 0,3$ valid only up to</p> <p>bzw. 30 % oder $w = 60^\circ$</p> <p>sonst $h_m = \frac{360 \cdot f_z \cdot a_e \cdot \sin(k)}{\pi \cdot d_e \cdot w_s}$ otherwise</p>								
	<p>Vorschubgeschwindigkeit v_f [mm/min] Feed rate v_f [mm/min]</p> $v_f = f_z \cdot n \cdot z$									
	<p>Vorschub pro Umdrehung f [mm/U] Feed per revolution f [mm/rev.]</p> $f = \frac{v_f}{n}$	<p>Zerspanungsvolumen Q [cm³/min] Chip removal rate Q [cm³/min]</p> $Q = \frac{a_p \cdot a_e \cdot v_f}{1000}$								
	<p>Vorschub pro Zahn f_z [mm/z] Feed per tooth f_z [mm/tooth]</p> $f_z = \frac{v_f}{n \cdot z}$ <p>gültig nur bis $\frac{a_e}{d_e} < 0,3$ valid only up to</p> <p>bzw. 30 % oder $w = 60^\circ$</p>	<p>Effektiver Schnittkreisdurchmesser [mm] Effective diameter of cutting</p> <p>Werkzeuge mit Eckenradius Milling cutter with corner radius</p> $S_d = 2 \cdot \sqrt{d_1} \cdot a_p - a_p^2$								
	<table border="1"> <tr> <td>Einstellwinkel k Plunge angle</td> <td>Vorschub pro Zahn f_z Feed per tooth</td> </tr> <tr> <td>90°</td> <td>f_z</td> </tr> <tr> <td>45°</td> <td>$f_z \cdot 1,414$</td> </tr> <tr> <td>30°</td> <td>$f_z \cdot 2$</td> </tr> </table> <p>sonst $f_z = \frac{h_m \cdot \pi \cdot d_e \cdot w_s}{360 \cdot a_e \cdot \sin(k)}$ otherwise</p>	Einstellwinkel k Plunge angle	Vorschub pro Zahn f_z Feed per tooth	90°	f_z	45°	$f_z \cdot 1,414$	30°	$f_z \cdot 2$	<p>Kugelkopierfräsen Ball Nose cutter</p> $S_d = d_1 - d + 2 \cdot a_p (d - a_p)$
	Einstellwinkel k Plunge angle	Vorschub pro Zahn f_z Feed per tooth								
	90°	f_z								
	45°	$f_z \cdot 1,414$								
	30°	$f_z \cdot 2$								
	<p>Theoretische Rauhtiefe Theoretical roughness</p> $R_{th} = \frac{d_1}{2} \cdot \sqrt{\frac{d_1^2 - b_r^2}{4}}$	<p>Spindeldrehmoment Spindle torque</p> $M_c = \frac{f_n \cdot \pi \cdot d_1^2 \cdot k_c}{4000}$								
<p>Zeilensprung Horizontal skip</p> $b_r = 2 \cdot \sqrt{R_{th} \cdot (d_1 - R_{th})}$	<p>benötigte Maschinenleistung required machine power</p> $P = \frac{Q}{LF}$									

Gültigkeit der Diagramme

für $a_p \geq 0,5 \cdot d_1$ bzw.
 $a_p \geq 0,5 \cdot d_4$ sonst

Berechnungsformeln siehe unten

Diagrams are valid

for $a_p \geq 0,5 \cdot d_1$ respectively
 $a_p \geq 0,5 \cdot d_4$ otherwise

see formula below

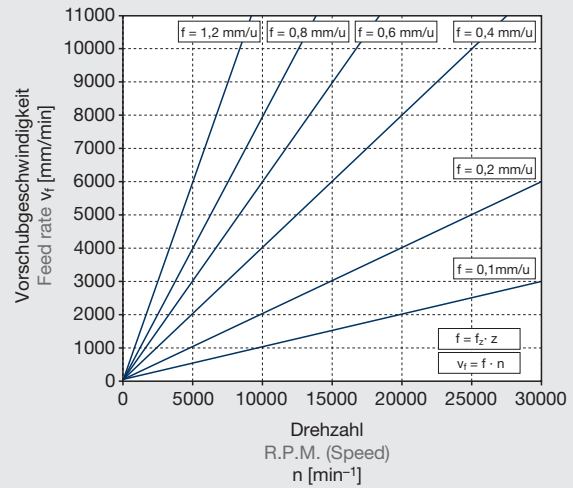
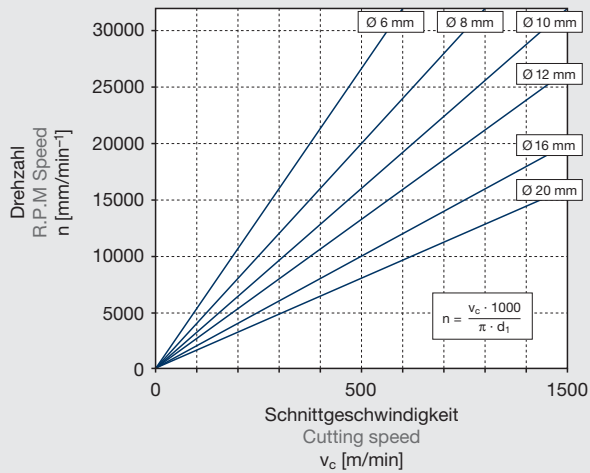

Kugelnkopierfräser
Ball nose copying milling cutter

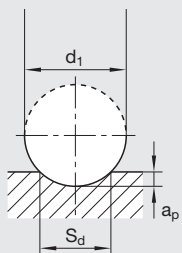

Kugelnkopierfräser mit einer
Schnitttiefe von
Ball nose copying milling cutter
with depth of cut
 $a_p < 0,5 \cdot d_1$

$$n = \frac{v_c \cdot 1000}{2 \cdot \pi \cdot \sqrt{d_1 \cdot a_p - a_p^2}} \quad [\text{min}^{-1}]$$

a_p = Schnitttiefe
Depth of cut [mm]

S_d = Schnittkreis-Ø
Cutting circle dia. [mm]

d_1 = Fräser-Ø
Milling Cutter dia. [mm]

$$S_d = 2 \cdot \sqrt{d_1 \cdot a_p - a_p^2}$$

Fräser mit Eckenradius
Milling cutter with corner radius

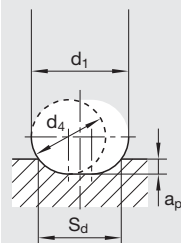

Fräser mit einer Schnitttiefe von
Cutter with depth of cut
 $a_p < 0,5 \cdot d_4$

$$n = \frac{v_c \cdot 1000}{(d_1 - d_4 + 2 \cdot \sqrt{d_4 \cdot a_p - a_p^2}) \cdot \pi} \quad [\text{min}^{-1}]$$

$d_4 = 2 \cdot \text{Eckenradius}$
 $2 \cdot \text{Corner radius}$ [mm]

$$S_d = d_1 - d_4 + 2 \cdot \sqrt{d_4 \cdot a_p - a_p^2}$$

z = Zähnezahl
No. of teeth

f_z = Vorschub/Zahn
Feed/Tooth [mm]

f = Vorschub/Umdrehung
Feed/Revolution [mm/u]

Kugelfräser
Ball nose cutter

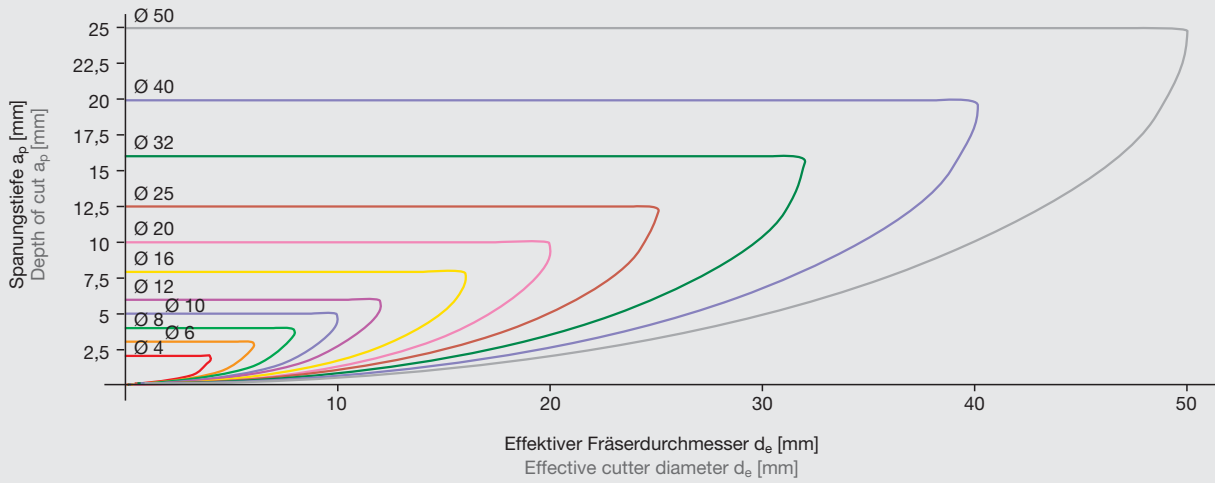

Kugelfräser (vergrößert)
Ball nose cutter (magnified)

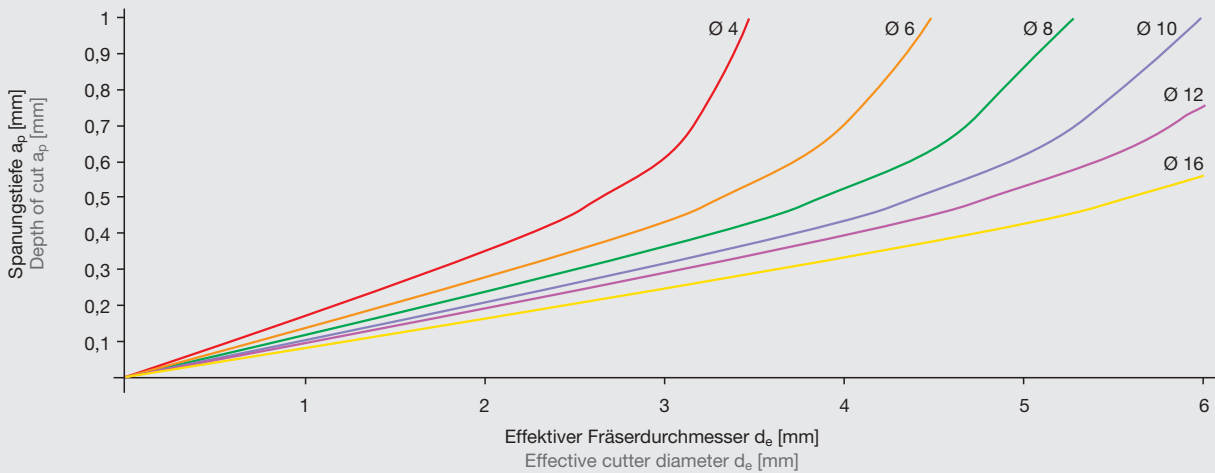

Kugelfräser Ball nose cutters													
Ø	Radius Radius	Schnitttiefe Depth of cut a _p in mm											
		0,05	0,1	0,15	0,2	0,25	0,3	0,5	1	1,5	2	2,5	3
0,3	0,15	0,224	0,283	0,300	0,283	0,224							
0,4	0,2	0,265	0,346	0,387	0,400	0,387	0,346						
0,5	0,25	0,300	0,400	0,458	0,490	0,500	0,490						
0,6	0,3	0,332	0,447	0,520	0,566	0,592	0,600						
0,8	0,4	0,387	0,529	0,624	0,693	0,742	0,775						
1	0,5	0,436	0,600	0,714	0,800	0,866	0,917						
1,5	0,75	0,539	0,748	0,900	1,020	1,118	1,200						
2	1	0,624	0,872	1,054	1,200	1,323	1,428	1,732					
2,5	1,25	0,700	0,980	1,187	1,356	1,500	1,625	2,000	2,449				
3	1,5	0,768	1,077	1,308	1,497	1,658	1,800	2,236	2,8828	3,000			
4	2	0,889	1,249	1,520	1,744	1,936	2,107	2,646	3,464	3,873	4,000		
5	2,5	0,995	1,400	1,706	1,960	2,179	2,375	3,000	4,000	4,583	4,899	5,000	
6	3	1,091	1,536	1,873	2,154	2,398	2,615	3,317	4,472	5,196	5,657	5,916	
7	3,5	1,179	1,661	2,027	2,332	2,598	2,835	3,606	4,899	5,745	6,325	6,708	
8	4	1,261	1,778	2,170	2,498	2,784	3,040	3,873	5,292	6,245	6,928	7,416	
9	4,5	1,338	1,887	2,304	2,653	2,958	3,231	4,123	5,657	6,708	7,483	8,062	
10	5	1,411	1,990	2,431	2,800	3,122	3,412	4,359	6,000	7,141	8,000	8,660	
11	5,5	1,480	2,088	2,551	2,939	3,279	3,583	4,583	6,325	7,550	8,485	9,220	
12	6	1,546	2,182	2,666	3,072	3,428	3,747	4,796	6,633	7,937	8,944	9,747	
14	7	-	2,358	-	3,323	3,708	4,055	5,196	7,211	8,660	9,798	10,724	11,489
16	8	-	2,522	-	3,555	3,969	4,341	5,568	7,746	9,327	10,583	11,619	12,490
20	10	-	2,821	-	3,980	4,444	4,862	6,245	8,718	10,536	12,000	13,229	14,283
25	12,5	-	3,156	-	4,454	4,975	5,444	7,000	9,798	11,874	13,565	15,000	16,248
30	15	-	3,458	-	4,883	5,454	5,970	7,681	10,770	13,077	14,967	16,583	18,000
32	18	-	3,572	-	5,044	5,635	6,168	7,937	11,136	13,528	15,492	17,176	18,655
40	20	-	3,995	-	5,643	6,305	6,902	8,888	12,490	15,199	17,436	19,365	21,071

Effektiver Schnittkreis Ø für Fräser mit Rundwendschneidplatten Effective diameter of cutting for round insert tools													
Ø	Radius WSP Radius WSP	Schnitttiefe Depth of cut a _p in mm											
		0,1	0,2	0,25	0,3	0,5	1	1,5	2	2,5	3		
16	3,5	10,661	11,332	11,598	11,835	12,606	13,899	14,745	15,325	15,708	15,928		
20	3,5	14,661	15,332	15,598	15,835	16,606	17,899	18,745	19,325	19,708	19,928		
20	5	11,990	12,800	13,122	13,412	14,359	16,000	17,141	18,000	18,660	19,165		
24	6	14,182	15,072	15,428	15,747	16,796	18,633	19,937	20,944	21,747	22,392		
25	3,5	19,661	20,332	20,598	20,835	21,606	22,899	23,745	24,325	24,708	24,928		
25	5	16,990	17,800	18,122	18,412	19,359	21,000	22,141	23,000	23,660	24,165		
32	6	22,182	23,072	23,428	23,747	24,796	26,633	27,937	28,944	29,747	30,392		
32	8	18,522	19,555	19,969	20,341	21,568	23,746	25,327	26,583	27,619	28,490		
35	5	26,990	27,800	28,122	28,412	29,359	31,000	32,141	33,000	33,660	34,165		
35	6	25,182	26,072	26,428	26,747	27,796	29,633	30,937	31,944	32,747	33,392		
42	5	33,990	34,800	35,122	35,412	36,359	38,000	39,141	40,000	40,660	41,165		
42	6	32,182	33,072	33,428	33,747	34,796	36,633	37,937	38,944	39,747	40,392		
52	6	42,182	43,072	43,428	43,747	44,796	46,633	47,937	48,944	49,747	50,392		
52	8	38,522	39,555	39,969	40,341	41,568	43,746	45,327	46,583	47,619	48,490		

Maximale Frästiefe beim Planfräsen $a_{p\max}$ (mm) mit Rundwendeplatten Maximum depth of cut for face milling $a_{p\max}$ (mm) with round inserts				
d	7	10	12	16
Schruppen Roughing	1,50	3,0	3,0	5,0
Schlichten Finishing	0,5	1,0	1,0	1,0

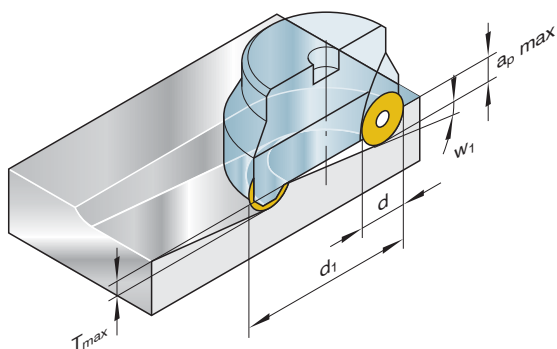

Maximaler Winkel W_1 beim schrägen Eintauchen mit Rundwendeplatten
 Maximum angle W_1 for inclined immersion with round inserts

d_1	7	10	12	16
8				
10				
12	8,0°			
15	5,7°			
16				
20	3,8°	6,3°		
24			6,3°	
25	2,9°	4,6°	5,9°	
30	2,3°	3,6°		
32			4,2°	6,3°
35	1,9°	3,0°	3,7°	
40			3,1°	
42		2,4°		
50			2,3°	3,3°
52			2,3°	
63			1,7°	2,5°
66			1,7°	2,4°
80			1,3°	1,9°
100				1,5°
125				1,1°
T_{\max}	0,75	1,25	1,5	2,0



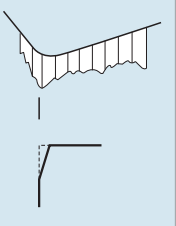
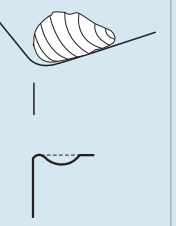
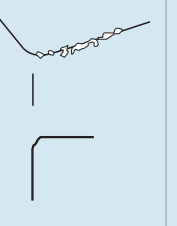
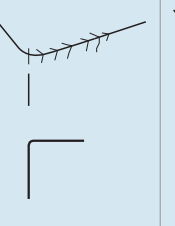

Problemlösungen zum Fräsen mit Wendepplatten

Trouble shooting for indexable milling

	Problem					
						
Abhilfe und Lösungen Removal and solutions	Freiflächen- Verschleiß Flank wear	Kolk- verschleiß Crater wear	Platten- absplitterungen Flaking	Kammrisse Thermal cracks	Ermüdungs- risse Fatigue cracks	
Verschleißfestere Hartmetall-Sorte Carbide grade with higher wear resistance	■	■				
Zähere Hartmetall-Sorte Tougher carbide grade			■	■	■	
Schnittgeschwindigkeit erhöhen Increase cutting speed			■			
Schnittgeschwindigkeit verringern Reduce cutting speed	■	■		■		
Vorschub pro Zahn erhöhen Increase feed per tooth	■					
Vorschub pro Zahn verringern Reduce feed			■	■	■	
Fräserpositionierung ändern Change cutter positioning					■	
Kleinerer Fräserdurchmesser Smaller cutter diameter				■		
Stabilität verbessern Improve rigidity			■			
Verwendung einer beschichteten Sorte Use coated inserts	■	■				
Kühlmittel verwenden Use coolant				■		

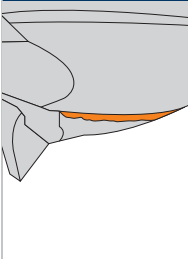
	 Plastische Verformung Plastic deformation	 Kerb-Verschleiß Notch wear	 Aufbau-schneidenbildung Built-up edge	 Schneidkantenbruch Cutting edge failure	 Vibrationen Vibration	 Schlechte Oberflächenqualität Poor surface quality
	■	■				■
				■		
			■			
	■	■				
			■		■	
	■	■		■		■
					■	
		■		■		
			■			
	■					

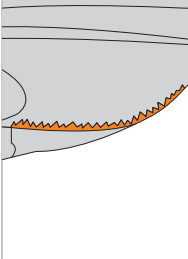
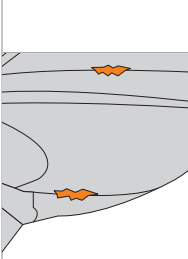
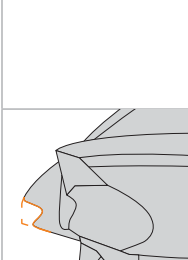
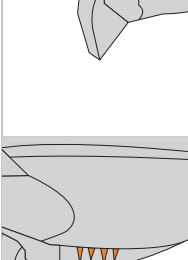
Art Type	Beschreibung Description	Maßnahmen Measures
 <p>Freiflächenverschleiß Abrieb an der Freifläche</p> <p>Flank wear Abrasion on the clearance</p>	<p>Freiflächenverschleiß entsteht durch Abrasion zwischen Werkstück und Schneidkante, also an der Freifläche.</p> <p>Flank wear is caused by abrasion between the workpiece and flank.</p>	<ul style="list-style-type: none"> ■ Schnittgeschwindigkeit verringern ■ Verschleißfesteren Schneidstoff verwenden ■ Vorschub erhöhen ■ Kühlmitteldruck erhöhen ■ Reduce cutting speed ■ Use more wear-resistant cutting material ■ Increase feed rate ■ Increase coolant pressure
 <p>Kolkverschleiß Aufbau an der Schneide und Auswaschung an der Spanfläche</p> <p>Crater wear Washout or build up at the rake face</p>	<p>Kolkverschleiß wird durch Diffusion und Abrasion auf der Spanfläche verursacht.</p> <p>Crater wear is caused by diffusion and abrasion of the cutting face.</p>	<ul style="list-style-type: none"> ■ Schnittgeschwindigkeit verringern ■ Härteren Schneidstoff verwenden ■ Vorschub erhöhen ■ Kühlmitteldruck erhöhen ■ Reduce cutting speed ■ Use harder cutting material ■ Increase feed rate ■ Increase coolant pressure
 <p>Aufbauschneide Aufklebung von Material auf der Spanfläche</p> <p>Built-up edge Adhesion of material along the cutting edge at the rake face</p>	<p>Aufgrund von Adhäsion (Anhaftung) bleiben Teile des Materials auf der Schneidkante kleben und eine Aufbauschneide bildet sich.</p> <p>Due to micro-cold welding, parts of the workpiece material adhere to the cutting edge, forming a build-up edge.</p>	<ul style="list-style-type: none"> ■ Schnittgeschwindigkeit erhöhen ■ Spanwinkel vergrößern ■ Werkzeuge mit schärferer Schneide verwenden ■ Vorschub verringern ■ Kühlmitteldruck erhöhen ■ Increase cutting speed ■ Increase cutting angle ■ Use tools with a sharper edge ■ Reduce feed rate ■ Increase coolant pressure
 <p>Ausbrüche Ausbrüche entlang der Schneidkante</p> <p>Chipping Chipping along the cutting edge</p>	<p>Ausbrüche entstehen aufgrund von Vibrationen, Späneschlag, Kammrisen und zu geringer Zähigkeit des Schneidstoffes.</p> <p>Chipping is caused by vibrations, impact of chips, thermal cracks and too less toughness of the carbide grade.</p>	<ul style="list-style-type: none"> ■ Schnittgeschwindigkeit verringern ■ Weniger scharfes Werkzeug verwenden ■ Zäheren Schneidstoff verwenden ■ Vorschub erhöhen ■ Kühlmitteldruck erhöhen ■ Reduce cutting speed ■ Use less sharp tools ■ Use tougher cutting material ■ Increase feed rate ■ Increase coolant pressure
 <p>Plastische Deformation Deformation an der Schneidkante (oft am Eckenradius)</p> <p>Plastic deformation Deformation on the cutting edge (especially at the corner radius)</p>	<p>Plastische Deformation wird durch hohe Wärmeeinwirkung in Kombination mit mechanischer Wechselbelastung verursacht.</p> <p>Plastic deformation is caused by excessive heat combined with mechanical stress.</p>	<ul style="list-style-type: none"> ■ Vorschub verringern ■ Verschleißfesteren Schneidstoff verwenden ■ Weniger scharfes Werkzeug verwenden ■ Kühlmitteldruck erhöhen ■ Reduce feed rate ■ Use more wear-resistant cutting material ■ Use less sharp tools ■ Increase coolant pressure
 <p>Kammrisse Gleichmäßige Risse im Werkzeug 90° zur Schneidkante</p> <p>Thermal cracks Uniform cracks in the tool orthogonal to the cutting edge</p>	<p>Kammrisse (Thermoschock) werden durch zu hohe thermische Wechsel verursacht.</p> <p>Thermal cracks are caused by thermal alternating stress (Thermal shock)</p>	<ul style="list-style-type: none"> ■ Schnittgeschwindigkeit verringern ■ Vorschub verringern ■ Kühlmitteldruck verringern ■ Reduce cutting speed ■ Reduce feed rate ■ Reduce coolant pressure

Mittige Anordnung
 Centerline location

$$\varphi_s = 2 \cdot \sin^{-1} \left(\frac{a_e}{d_1} \right)$$

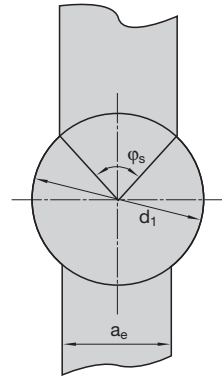

Kanten fräsen
 Edge milling

$$\varphi_s = \sin^{-1} \left(\frac{a_e - \frac{d_1}{2}}{\frac{d_1}{2}} \right) + 90$$

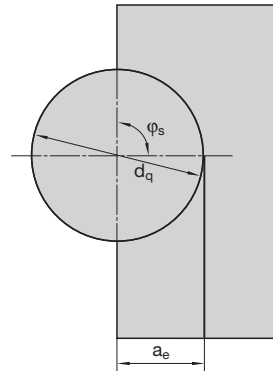

Versetzt Fräsen
 Adjusted milling

$$\sin \varphi_1 = \frac{2 \cdot \left(\frac{d_1}{2} - a_{ue} \right)}{d_1}$$

$$\sin \varphi_2 = \frac{2 \cdot (a_e - a_{e1})}{d_1}$$

$$\sin \varphi_s = \sin \varphi_1 + \sin \varphi_2$$

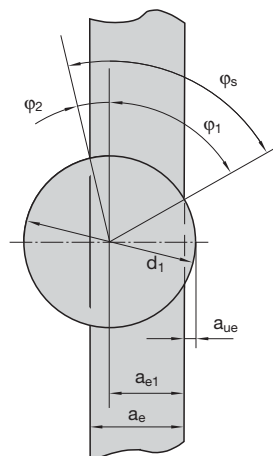

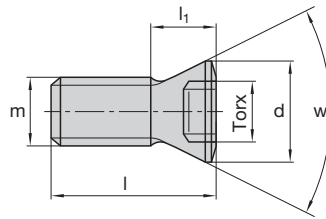

						Anzugsmoment Torque (Nm)
Ident No.	M	L (mm)	d (mm)		Ident No.	
1045604	1,8	3,8	2,75	T06	1048434	0,7
6119610	2	4,2	3,6	T06	6119544	0,6
1044972	2,5	6	3,5	T08	1048326	1,2
2127640	2,5	5,5	3,5	T08	1048326	1,2
6119627	2,5	4,5	3,5	T07	1048431	1,2
2237513	3	7,3	4,1	T08	1048326	2,25
9199156	3	6,5	4,1	T08	1048326	2,25
6119613	3	6,2	5	T08	6119528	2
1051277	3,5	6,5	5,5	T15	1048335	3,5
1044981	3,5	7,5	5,5	T15	1048335	3,5
1045105	3,5	8,5	5,5	T15	1048335	3,5
1045114	3,5	9,5	5,5	T15	1048335	3,5
1045819	3,5	4,3	5,5	T10	1048433	3,5
1045828	3,5	5,3	5,5	T10	1048433	3,5
1045126	4	11	5,5	T15	1048335	5,2
1045131	4	9	5,5	T15	1048335	5,2
1051312	4	7,5	5,5	T15	1048335	5,2
1045133	4	10	7,5	T20	1148422	5,2
6119512	4	5,5	11,5	T15	1048335	4
6119602	4	9,5	5,5	T15	6119529	4
1044963	4,5	12	6,6	T20	1048344	7,6
1044990	4,5	11,5	6,6	T20	1048344	7,6
1045123	4,5	10	6,6	T20	1048344	7,6
1045777	5	12	7,2	T20	1048344	10
1045766	5	10	7,2	T15	1048335	8

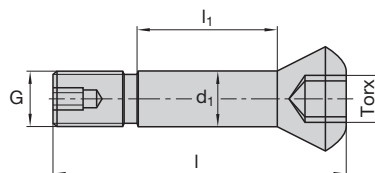

							Anzugsmoment Torque (Nm)
Ident No.	LMT-Code	M	L (mm)	d (mm)		Ident No.	
6260409	GWS 06	2,2	5	2,5	T6	1048434	0,5
6119572	GWS 08	3	6,95	3	T8	1048326	1
6119571	GWS 10	4	8,5	4	T15	1048335	3
6119559	GWS 12	5	9,1	5	T20	1048444	4
6119560	GWS 16	5	12,75	5	T20	1048444	5
6119561	GWS 20	5	15,35	5	T20	1048444	5
6119562	GWS 25	6	20,55	6	T30	6119533	8
6119563	GWS 32	8	24,7	8	T30	6119533	8
7245402	GWS-D 12	4	10,2	6	20IP	7247494	5
7146468	GWS-D 16	4,5	13,8	7,5	20IP	7188874	6
7168007	GWS-D 20	5	17	9	20IP	7188874	6
7168008	GWS-D 25	5,5	20	10,5	25IP	7188875	8
7189758	GWS-D 32	8	25	12	30IP	7230276	10

Fräsen mit Schaftfräsern Milling with end mills

- 1 Abmessung nach
Dimension according
- 2 Ausführung Schneidkante
Cutting edge design
- 3 Drallwinkel
Helix angle
- 4 Toleranzklasse
Tolerance
- 5 Anwendung
Application

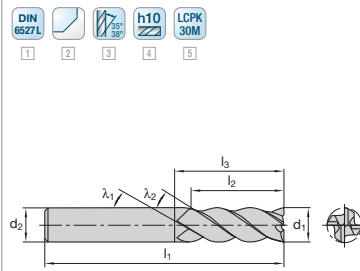

Fräsen mit Wendeschneidplatten Milling with indexable inserts

- 1 Prozesse
(Schruppen, Schlichten etc.)
Processer
(Roughing, finishing etc.)
- 2 Anwendungen
(Haupt- und Nebenanwendungen)
Applications
(Main and alternative applications)
- 3 Innenkühlung, seitlicher Austritt
Internal cooling, side outlet
- 4 Air-Jet
Air-Jet
- 5 Werkstoffhärte < 58 HRC
Material hardness < 58 HRC

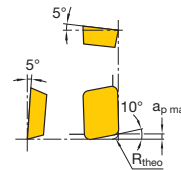
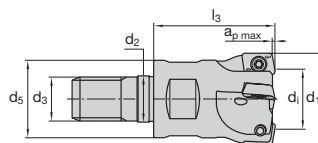

Schneidstoffsorten
Cutting materials
Ident No.

Für Fräser
For cutter
Cat-No.

*) Piktogramme bei LMT Kieninger Wendeschneidplatten
Pictograms LMT Kieninger Indexable inserts

Normen für Schäfte und Schneiden
Standards for shanks and cutting edges

DIN 327 D Entspricht DIN 228 B
Corresponds with DIN 228 B

DIN 844 B	DIN 850 D	DIN 851 AB	DIN 885 A	DIN 1833 C	DIN 1833 D	DIN 1834 A	DIN 1834 B	DIN 1835 A	DIN 1835 B
DIN 1880	DIN 2328	DIN 6518 B	DIN 6527 L	DIN 6528	DIN 6528 B	DIN 6535	DIN 6535 HA	DIN 6535 HB	DIN 8030 A
DIN 69871 A	LMT Fette Standard	LMT Onsrud Standard							

Anwendungen
Applications

Ti Warmfeste Legierungen Heat resistant alloys	HRC > 58 Werkstoffhärte > 58 HRC Material hardness > 58 HRC
HRC < 52 Werkstoffhärte < 52 HRC Material hardness < 52 HRC	HRC < 58 Werkstoffhärte < 58 HRC Material hardness < 58 HRC
HRC 52-65 Werkstoffhärte < 52-65 HRC Material hardness < 52-65 HRC	HRC > 60 Werkstoffhärte > 60 HRC Material hardness > 60 HRC
HRC < 55 Werkstoffhärte < 55 HRC Material hardness < 55 HRC	

Schneidstoffe
Cutting materials

Solid Carbide Vollhartmetall Solid carbide	HSS E-PM Pulvermetallurgischer HSS-Stahl Powder-metallurgical steel
HSS-E Schnellarbeitsstahl High speed steel	CBN Kubisches Bornitrit Cubic boron nitride
PCD Polykristalliner Diamant Polycrystalline diamond	

Beschichtungen
Coatings

Diamondbeschichtet
Diamond coated

AL2 Plus	Al6	Nano-sphere Red	Al Nano
-----------------	------------	------------------------	----------------

Kantenprofile, Drall, Drallwinkel
Edge profiles, spiral, spiral angle

120° entspricht Drallwinkel 10°
corresponds with 10° spiral angle

125° 130° 140° 145° 150°

33°/35°/37° 35°/38° 41°/44° ungleich geteilter Drall
uneven helix angle

10° bis 12° 14° kreuzverzahnt
staggered tooth

geradeverzahnt
straight tooth

Toleranzklassen
Tolerance classes

e8 Schneidentoleranzen
Edge tolerances

h7	h8	h9	h10	h11	h12	js12	js14	js16	k10
k12	d11	+0,03 / 0	0,25 / -0,15	0 / -0,03					

h5 Schafttoleranzen
Shank tolerances

h6

Besonderheiten
Special features

Zentrale Innenkühlung Central internal cooling	Radiale Innenkühlung Internal cooling radial
Trockenbearbeitung Dry machining	Nassbearbeitung Wet machining
Air Jet Air Jet	

Aufnahmegrößen
Holder sizes

HSK-A Form Forme	MK 2	MK 3	MK 4
----------------------------	-------------	-------------	-------------

Schneidstoffsorten
Cutting material grades

LC 630T	LW 630	LCHP 15M	LCMS 30M	LCN 15M	LCPK 30M	LCSM 20M	LWNP 30M	LC 620T	LC 620Q
LCKP 10M	LCHK 10M	LC 620ZM	LCHP 20M	LCHK 20M					

Prozesse Processes	
Schruppen Roughing	Schruppen + Semischlichten Roughing + Semi finishing
Semischlichten Semi finishing	Schruppen + Schlichten Roughing + Finishing
Schlichten Finishing	Semischlichten + Schlichten Semi finishing + Finishing
Feinstschlichten Superfinishing	
Planfräsen Face milling	Nutenfräsen Slotting
Kopierfräsen Copying	Taschenfräsen Pocket milling
Eckfräsen Corner milling	Zirkularfräsen Circular milling
Außenkonturfräsen Contour milling	Trochoidalfräsen Trochoidal milling
Hochvorschubfräsen High feed milling	

Schneidenlängen Cutting length	
	extra kurz, kurz, lang, extra lang extra short, short, long, extra long

Besonderheiten Special features	
Eckenradius Corner radius	Kantenschutzfase Edge protection chamfer
Gerade Scarp corner	Kugel Ball Nose
Hochvorschub High Feed	
$d_1 < d_3$ Konischer Schneidenteil Tapered cutting portion	
Schmal Narrow	
js14 Schneidenbreite js14 Cutting width js14	k11 Schneidenbreite k11 Cutting width k11
e8 Schneidenbreite e8 Cutting width e8	d11 Schneidenbreite d11 Cutting width d11

Halsformen Neck forms	

Katalognummer Catalog number	Seite Page
29-050	120
29-100	121
32-200	122
52-700	108
54-200	110
60-200	109
63-850	106
64-000	107
65-000	107
65-200B	124
66-500	111
66-700	112
66-750	113
66-775	114
66-800	115
66-900	116
67-200	117
68-200	118
68-300	119
68-400	126
77-100	125
1013	173, 189
1013C	173, 189
1015	173, 189
1015C	173, 189
1016	173, 189
1016C	173, 189
1179-11	442
1179-21	442
1179-25	442
1179-35	442
1179-41	442
1179-45	442
1179-55	442
1324A	173, 192
1400C	47
1410C	42, 43
1411C	80
1412C	50, 51
1413C	80
1415	140, 141
1415C	140, 141
1417C	137
1418C	136
1419	142, 143
1419C	142, 143
1425C	130
1426C	130
1428C	131
1429C	131
1430C	54, 55
1431C	102
1443C	81
1450C	84, 85
1451C	98
1461C	31
1462C	31
1464C	32
1465C	144, 145

Katalognummer Catalog number	Seite Page
1466C	146, 147
1468C	148
1469C	149
1475C	150
1476C	151
1520C	60
1521C	58, 59
1522C	58, 59
1524C	36
1525C	68
1526C	37
1528C	30
1529C	30
1544C	36
1550C	38
1563C	128
1564C	128
1565C	68
1571	76
1572	76
1576C	37
1584	132
1584C	133
1585	132
1585C	133
1591C	129
1592C	129
1602	173, 196
1602C	173, 196
1641	173, 197
1820C	64, 65
1821C	64, 65
1830C	72
1831C	72
1837C	73
1840C	89
1841C	89
1854C	93
1864C	94
ADHX	428, 429
ADKX	430, 431
ADT T	166, 167
CMR ... DR/SR	447
CopyMax1	321
CopyMax2	322
CPHX	448
EBC	212, 215
EBG R	215
EBT (11497)	217
EBT 11493	402
EBT THR 11497	402
ECC	212
ECG	212, 316, 317
ECP	210, 284, 285
ECP IK	280
ECP V07 IK	285
ECP V09 IK	285

Katalognummer Catalog number	Seite Page
ECP X07	210
ECZ / ECC	303
ECZ	212, 304
EFZ (1148)	217, 411
EFZ45 (11483)	217, 412
EHP IK	275
EHP X09	210
EMU90	209
EMU90 IK	219, 220, 221
EMZ 90 IK	406
EMZ 90 THR IK	406
EMZ90	217
ERU90	209, 223
ESP90 (11403)	217
ESP90 11403 IK	413
F406	181
F406C	171, 181
F445	171, 180
F445C	171, 180
F454C	171, 184
F515C	171, 178
F519C	171, 179
F523	171, 182
F523C	171, 182
F524	171, 183
F525	171, 183
FCC	212, 305, 307, 308
FCG	212, 316
FCP	210, 286
FCP V09 IK	286
FCP V12 IK	286
FCT45	210, 260
Feed-Jet ... PLUS	212
FHP IK	275
FHP X09	210
FMH45	209, 245
FMN45	209
FMN45 IK	256
FMP45	210, 251, 270
FMP90T L	209, 237
FMP90T X	209, 233
FMT90	209, 240
FMU90	209
FMU90 IK	222
FMV45	210, 266
FMZ90	217
FMZ90 IK	407
FRU90	209, 223
GRT	215, 330, 331
GWR	215, 339, 341, 342, 343, 344, 345
GWR 5x	215, 340

Katalognummer Catalog number	Seite Page
GWV	215, 217, 366, 367, 368, 369
HFN	210
HFN S12	288
LNHU	431
LNHX	431, 432
LNMU	442
OCKX	432
OEKT	433
ONGU	434
ONMU	434
ONMW	434
Quattro-Jet AF	161
Quattro-Jet FB	160
Quattro-Jet HF	160
Quattro-Jet SF	161
RCHX	435, 436, 437
RCKT	435
RCKX	436, 437
RDHW	437, 449, 450
RDHX	437, 449, 450
RDKT	450
RDKX	449, 450
RNKX	451
RNLU	451
S12	210
SAHT	438
SAKT	438
SEHT	438, 439
SEKT	439
SMN90 1103	416
SMN90 11035	417
SMN90	217
SNHX	439
SNKQ	440
SNKX	440
SOKX	441
SpeedLift	212, 292
SPGT	453
SPGW	452, 453
SPKX	441
SPMT	441
SPMW	441
TCMT	442
TPET	453
TPEW	452, 453
VCGT	442
VPGT	442
WPB AF	454
WPB CF	459
WPB FB	455
WPB HF	456
WPB N	457, 458
WPR AR	460
WPR AS	461

Katalognummer Catalog number	Seite Page
WPR CF	462
WPR D	463
WPR DN	464
WPR N	465
WPR SF	466
WPS A	461

Katalognummer Catalog number	Seite Page
WPT A	467
WPV CF	468
WPV N	469
WRT	470
XCKX	442
XCNT	443

Katalognummer Catalog number	Seite Page
XCNW	443
XDMT	444
XDMW	444
XNGU	434
XNMU	444
XOKX	444

Katalognummer Catalog number	Seite Page
XPHW	445
XPMT	445
XPMW	445



Unsere komplette Katalogreihe „Werkzeuge und Wissen“
Our complete catalog serie “Tools and Knowledge”



LMT Tools Gewinden und Bohren
Werkzeuge und Wissen
LMT Tools Threading and Drilling
Tools and Knowledge



LMT Tools Reiben
Werkzeuge und Wissen
LMT Tools Reaming
Tools and Knowledge



LMT Fette Rollsysteme
Werkzeuge und Wissen
LMT Fette Rolling Systems
Tools and Knowledge



LMT Fette Verzahnen
Werkzeuge und Wissen
LMT Fette Gear Cutting
Tools and Knowledge

LMT Tools Niederlassungen und Servicestandorte

LMT Tools subsidiaries and service organisation

Brasilien/Brazil

LMT Tools Brasil
Av. Cambacica 1200
Módulo 11
13097-160 São Paulo
Telefon +55 19 982439910
Telefax +55 11 55460476
contato@lmt-tools.com

China

LMT China Co. Ltd.
No. 9 Lanzhi Road
Jiangning Development Zone
211100 Nanjing
Telefon +86 25 52128866
Telefax +86 25 52106376
lmt.cn@lmt-tools.com

Deutschland/Germany

LMT Tool Systems
GmbH & Co. KG
Heidenheimer Strasse 84
73447 Oberkochen
Telefon +49 7364 9579-0
Telefax +49 7364 9579-8000
info@lmt-tools.com

Frankreich/France

LMT Belin France S.A.S.
Lieu dit „Les Cizes“
01590 Lavancia
Telefon +33 474 758989
Telefax +33 474 758990
belin@lmt-belin.com

Großbritannien und Irland/ United Kingdom and Ireland

LMT UK Ltd.
Unit 4202 Waterside Centre
Solihull Parkway
Birmingham Business Park
B377YN Birmingham
Telefon +44 121 7175830
Telefax +44 121 7175838
lmt.uk@lmt-tools.com

Indien/India

LMT (India) Private Limited
Plot No. A-40/1
Phase I, MIDC
Chakan Industrial Area Village:
Nighoje, Tal: Khed
410501 Pune
Telefon +91 2135614900
Telefax +91 42337704
sales@lmt-tools.co.in

Korea

LMT Korea Co. Ltd.
Room 1212
Anyang Trade Center
161 Simin-daero, Dongan-Gu
Anyang-Si
431-817 Gyeonggi-Do
South Korea
Telefon +82 31 3848600
Telefax +82 31 3842121
lmt.kr@lmt-tools.com

Mexiko/Mexico

LMT Tools Mexico, SA de CV
Adolfo Prieto No. 1638
Colonia Del Valle Sur
03100 Mexico, DF
Telefon +52 55 40000653
Telefax +52 44 22215555
info@lmt.com.mx

Rumänien/Romania

LMT Tool Systems RO SRL
Business Center Sibiu
Camera 301, Etaj 3
Str. Sibiului nr. 2
557260 Selimbar, Sibiu
Telefon +40 269 246092
Telefax +40 269 560614
lmt.ro@lmt-tools.com

Russland/Russia

LLC LMT Tools
Serebryanicheskaya nab., 27
109028 Moscow
Telefon/Telefax +7 495 2807352
info@lmt-russia.ru

Spanien/Spain

LMT Tool Systems GmbH
Sucursal en España
C/Agricultura local no.12
planta 1 no. 16-18
08320 El Masnou
Telefon +34 937127435
Telefon/Telefax +34 935407002
jrodriguez@lmt-tools.com

Tschechische Republik und Slowakei/

Czech Republic and Slovakia
LMT Czech Republic s.r.o.
Dusikova 3
63800 Brno-Lesná
Telefon +420 548 218722
Telefax +420 548 218723
lmt.fette@iol.cz

USA

Kanada/Canada
LMT USA Inc.
1081 S. Northpoint Blvd.
Waukegan, IL 60085
Telefon +1 847 3621560
Telefax +1 847 4731934
lmt.us@lmt-tools.com

Internationale Vertriebsgesellschaft/ International sales organisation

LMT Tool Systems

GmbH & Co. KG
Heidenheimer Strasse 84
73447 Oberkochen,
Deutschland
Telefon +49 7364 9579-0
lmt.de@lmt-tools.com
www.lmt-tools.com

Center of Competence Europe

**LMT Fette Werkzeugtechnik
GmbH & Co. KG**
Grabauer Strasse 24
21493 Schwarzenbek,
Deutschland
Telefon +49 4151 12-0
info@lmt-fette.de
www.lmt-tools.com

Center of Competence USA

LMT USA Inc.
1081 S. Northpoint Blvd.
Waukegan, IL 60085
Telefon +1 847 3621560
Telefax +1 847 4731934
lmt.us@lmt-tools.com
www.lmt-tools.com

Center of Competence India

LMT (India) Private Limited
A-40/1, Chakan Industrial Area,
MIDC Phase – 1,
Village – Nighoje,
Tal. – Khed, Dist. – Pune,
410501 Maharashtra, India
Telefon +91 2135 614900
sales@lmt-tools.co.in
www.lmt-tools.com

Center of Competence China

LMT China Co. Ltd.
No. 9 Lanzhi Road,
Jiangning Development Zone
211100 Nanjing, China
Telefon +86 25 52128866
lmt.cn@lmt-tools.com
www.lmt-tools.com

LMT Belin France S.A.S.

Lieu dit „Les Cizes“
01590 Lavancia
Frankreich
Telefon +33 474 758989
Telefax +33 474 758990
info@lmt-belin.com
www.lmt-belin.com

LMT Fette Werkzeugtechnik GmbH & Co. KG

Grabauer Strasse 24
21493 Schwarzenbek
Deutschland
Telefon +49 4151 12-0
Telefax +49 4151 3797
info@lmt-fette.com
www.lmt-fette.com

LMT Kieninger GmbH & Co. KG

Vogesenstrasse 23
77933 Lahr
Deutschland
Telefon +49 7821 943-0
Telefax +49 7821 943 213
info@lmt-kieninger.com
www.lmt-kieninger.com

LMT Onsrud LP

1081 S. Northpoint Blvd.
Waukegan, IL 60085
USA
Telefon +1 847 3621560
Telefax +1 847 4731934
info@onsrud.com
www.onsrud.com

LMT Tools

**BELIN
FETTE
KIENINGER
ONSRUD**